

UNIVERSAL
LIBRARY

OU 168776

UNIVERSAL
LIBRARY

**TEXT FLY WITHIN
THE BOOK ONLY**

OSMANIA UNIVERSITY LIBRARY

Call No. 661/H16A. Accession No 9197.

Author Hale, Arthur J.

Title Applications of electrolysis in chemical

This book should be returned on or before the date last marked below.

MONOGRAPHS ON INDUSTRIAL CHEMISTRY

Edited by Sir EDWARD THORPE, C.B., LL.D., F.R.S.

Emeritus Professor of General Chemistry in the Imperial College of Science and Technology,
South Kensington; and formerly Principal of the Government Laboratory, London.

INTRODUCTION

DURING the last four or five decades the Applications of Chemistry have experienced an extraordinary development, and there is scarcely an industry that has not benefited, directly or indirectly, from this expansion. Indeed, the Science trenches in greater or less degree upon all departments of human activity. Practically every division of Natural Science has now been linked up with it in the common service of mankind. So ceaseless and rapid is this expansion that the recondite knowledge of one generation becomes a part of the technology of the next. Thus the conceptions of chemical dynamics of one decade become translated into the current practice of its successor; the doctrines concerning chemical structure and constitution of one period form the basis of large-scale synthetical processes of another; an obscure phenomenon like Catalysis is found to be capable of widespread application in manufacturing operations of the most diverse character.

This series of Monographs will afford illustrations of these and similar facts, and incidentally indicate their bearing on the trend of industrial chemistry in the near future. They will serve to show how fundamental and essential is the relation of principle to practice. They

will afford examples of the application of recent knowledge to modern manufacturing procedure. As regards their scope, it should be stated the books are not intended to cover the whole ground of the technology of the matters to which they relate. They are not concerned with the technical *minutiae* of manufacture except in so far as these may be necessary to elucidate some point of principle. In some cases, where the subjects touch the actual frontiers of progress, knowledge is so very recent and its application so very tentative that both are almost certain to experience profound modification sooner or later. This, of course, is inevitable. But even so such books have more than an ephemeral interest. They are valuable as indicating new and only partially occupied territory; and as illustrating the vast potentiality of fruitful conceptions and the worth of general principles which have shown themselves capable of useful service.

Organic Compounds of Arsenic and Antimony. By G. T. MORGAN, F.R.S., F.I.C., M.R.I.A., D.Sc., A.R.C.Sc., Professor of Applied Chemistry, City and Guilds Technical College, Finsbury, London. 16s. net.

Edible Oils and Fats. By C. A. MITCHELL, F.I.C. 6s. 6d. net.

Coal and its Scientific Uses. By W. A. BONE, D.Sc., F.R.S., Imperial College of Science and Technology, South Kensington. 21s. net.

The Zinc Industry. By ERNEST A. SMITH, The Assay Office, Sheffield. 10s. 6d. net.

Colour in Relation to Chemical Constitution. By E. R. WATSON, M.A., D.Sc., Professor of Chemistry, Dacca College, Bengal. 12s. 6d. net.

The Applications of Electrolysis in Chemical Industry. By ARTHUR J. HALE, B.Sc., F.I.C., Finsbury Technical College, London.

The Natural Organic Colouring Matters. By A. G. PERKIN, F.R.S., The Dyeing Department, The University, Leeds; and A. E. EVEREST, D.Sc., Ph.D., Technical College, Huddersfield.

Catalysis in Industrial Chemistry. By G. G. HENDERSON, M.A., D.Sc., LL.D., F.R.S., The Royal Technical College, Glasgow.

The following Volumes are in preparation:—

Liquid Fuel for Internal Combustion Engines. By Sir BOVERTON REDWOOD, Bart., D.Sc., F.R.S.E., and J. S. S. BRAME, Royal Naval College, Greenwich.

- Synthetic Colouring Matters: Sulphur Dyes.** By G. T. MORGAN, D.Sc., A.R.C.S., F.R.S., Finsbury Technical College, London.
- Synthetic Colouring Matters: Vat Colours.** By JOCELYN F. THORPE, C.B.E., D.Sc., F.R.S., Imperial College of Science and Technology, South Kensington.
- Naphthalene.** By W. P. WYNNE, D.Sc., F.R.S., The University, Sheffield.
- Synthetic Colouring Matters: Azo-Dyes.** By FRANCIS W. KAY, D.Sc., The University, Liverpool.
- Utilisation of Atmospheric Nitrogen: Synthetical Production of Ammonia and Nitric Acid.** By A. W. CROSSLEY, C.M.G., D.Sc., F.R.S., F.I.C., King's College, Strand.
- Cement.** By BERTRAM BLOUNT, F.I.C.
- The Principles and Practice of Gas-purification.** By EDWARD V. EVANS, F.I.C., Chief Chemist, South Metropolitan Gas Company.
- Refractories.** By J. W. MELLOR, D.Sc.
- Ozone and Hydrogen Peroxide: their Properties, Technical Production and Applications.** By H. VINCENT A. BRISCOE, D.Sc., A.R.C.S., Imperial College of Science and Technology, South Kensington.
- The Nickel Industry.** By WILLIAM G. WAGNER.
- Cellulose-Silk.** By C. F. CROSS, B.Sc., F.R.S., F.I.C.
- The Electric Arc in Chemical Industry.** By J. N. PRING, D.Sc., The University, Manchester.
- By-Product Coking Practice.** By ERNEST BURY, M.Sc.
- Organic Synthetic Reactions: their Application to Chemical Industry.** By JULIUS B. COHEN, B.Sc., Ph.D., F.R.S.
- Synthetic Colouring Matters: Triphenylmethane Dyes.** By R. ROBINSON, D.Sc., Professor of Organic Chemistry in the University of Liverpool.
- Synthetic Colouring Matters: Anthracene and Allied Dye-stuffs.** By F. W. ATACK, M.Sc. Tech., B.Sc. (Lond.), F.I.C. of the Municipal School of Technology, Manchester.
- Synthetic Colouring Matters: Acridine and Xanthene Dye-stuffs.** By JOHN T. HEWITT, M.A., D.Sc., F.R.S., University of London (East London College).
- Synthetic Colouring Matters: Azine and Oxazine Dye-stuffs.** By JOHN T. HEWITT, M.A., D.Sc., F.R.S., University of London (East London College).
- Synthetic Drugs: Local Anæsthetics.** By W. H. HURTLEY, D.Sc., St. Bartholomew's Hospital; and M. A. WHITELEY, D.Sc., Imperial College of Science and Technology, South Kensington.

LONGMANS, GREEN AND CO.
LONDON, NEW YORK, BOMBAY, CALCUTTA, AND MADRAS.

MONOGRAPHS ON INDUSTRIAL CHEMISTRY
EDITED BY SIR EDWARD THORPE, C.B., LL.D., F.R.S.

THE APPLICATIONS OF
ELECTROLYSIS IN CHEMICAL INDUSTRY

THE APPLICATIONS OF ELECTROLYSIS IN CHEMICAL INDUSTRY

BY

ARTHUR J. HALE, B.Sc., F.I.C.

*Demonstrator and Lecturer in Chemistry
The City and Guilds of London Technical College, Finsbury*

WITH DIAGRAMS

LONGMANS, GREEN AND CO.

39 PATERNOSTER ROW, LONDON

FOURTH AVENUE & 30TH STREET, NEW YORK

BOMBAY, CALCUTTA, AND MADRAS

1918

PREFACE

171

THE scope and purpose of this volume are sufficiently indicated by its title. Electrolysis now plays an important part in the processes of Chemical Industry, and the value of Electro-Chemistry is generally recognised.

It is hoped that this work will prove useful to all those who are associated in any way with Chemical Science, and that it may stimulate interest in a rapidly growing branch of Chemistry which is worthy of more serious attention.

An account of the general principles of electrolysis and an explanation of the terms relating thereto have been given in the Introduction, and, at the suggestion of the Editor, a chapter has been included on methods of generating current.

These two sections should prove serviceable to the student and the general reader, and the numerous references to original papers will give those who may desire it an introduction to the literature of the subject.

The Author wishes to record his indebtedness to Mr. L. W. Phillips, A.M.I.E.E., for valuable assistance in connection with the chapter on methods of generating current.

LONDON, *July 1918.*

CONTENTS

	PAGE
INTRODUCTION	I
Electrolysis—The ionic theory—Faraday's laws—Osmotic pressure—Electrical units—Decomposition voltage—Electrical osmosis—Cataphoresis—Colloids in electrolysis—Current efficiency—Energy efficiency—Electrolysis bath—Electrodes—Diaphragms—Molten electrolytes	

CHAPTER I

METHODS OF GENERATING THE CURRENT	16
<i>Primary Cells</i> : Simple voltaic cell—Daniell's cell—Leclanché cell—Lelande cell—Fuel cells. <i>Secondary cells</i> : Reactions of lead accumulator—The thermopile—Dynamo-electric machines—Alternating and direct current—The rotary converter—Motor generator—Transformers—Measurement of current—Ammeters and voltmeters. <i>Power and electro-chemical industry</i> : Costs of power from various sources—Power prospects in the United Kingdom.	

CHAPTER II

THE ELECTROLYTIC REFINING OF METALS	33
<i>Copper</i> : Multiple and series systems. <i>Lead</i> : Fluosilicate process—Perchlorate process. <i>Tin. Iron. Cadmium. Bullion refining (Silver and Gold)</i> : Process of Moebius—Philadelphia Mint—Raritan copper works process—Balbach-Thum process—Wohlwill process for gold.	

CHAPTER III

THE ELECTROLYTIC WINNING OF METALS	5
Aluminium. <i>Copper</i> : Marchese process—Process of Siemens and Halske—Hoepfner process. <i>Zinc</i> : Electrolysis of aqueous solutions—Electrolysis of fused zinc chloride. <i>Lead</i> : Salom's process. <i>Nickel</i> : Hoepfner process—Process of Savelsburg and Wannschaff—Browne process. <i>Sodium</i> : Castner process—Darling process—Contact Electrode process—Ashcroft process. <i>Magnesium. Calcium. Lithium. Antimony. Bismuth.</i>	

	PAGE
CHAPTER IV	
ELECTROLYTIC PRODUCTION OF HYDROGEN AND OXYGEN	79
Quantitative relations—Historical—Schmidt's process—Schoop's process—Process of Garuti—Schuckert process—Cell of the International Oxygen Company—Modern filter-press cells—Electrolytic production of ozone.	
CHAPTER V	
ELECTROLYSIS OF ALKALI CHLORIDES : CHLORINE AND CAUSTIC SODA	90
General principles— <i>Diaphragm cells</i> : Griesheim cell—Hargreaves-Bird process—Outhenin-Chalandre cell—Townsend cell—Finlay cell—MacDonald cell—Le Seur cell—Billiter-Siemens cell. <i>Mercury cells</i> : Castner-Kellner cell—Solvay cell—Whiting cell—Rhodin cell—Wilderman cell. <i>The Bell Process</i> : Aussig bell process—Billiter-Leykam cell. <i>Electrolysis of fused salt</i> : The Acker process. Present position and future of Electrolytic Alkali.	
CHAPTER VI	
ELECTROLYSIS OF ALKALI CHLORIDES : HYPOCHLORITES, CHLORATES, PERCHLORATES.	116
General Principles—Kellner cell for hypochlorite—Schuckert cell—Haas-Oettel cell—Schoop cell for hypochlorite. <i>Chlorate production</i> : Gibb's process—Process of Lederlin and Corbin—Perchlorates—Bromine and bromates—Iodine.	
CHAPTER VII	
PRODUCTION OF INORGANIC COMPOUNDS.	130
White lead—Lead peroxide—Chrome yellow—Cuprous oxide—Percarbonates—Hydroxylamine—Hydrosulphites—Persulphuric acid and hydrogen peroxide—Potassium permanganate—Potassium ferricyanide—Nitric acid—Fluorine.	
CHAPTER VIII	
PRODUCTION OF ORGANIC COMPOUNDS	139
Iodoform—Anthraquinone—Vanillin—Isopropyl alcohol—Chloral—Saccharine—Reduction of nitro-compounds—Electrolytic oxidation of organic compounds—Coal tar dyes,	
SUBJECT INDEX	144
NAME INDEX	147

ABBREVIATIONS EMPLOYED IN THE REFERENCES.

ABBREVIATED TITLE.	JOURNAL.
<i>Amer. Chem. Journ.</i>	. American Chemical Journal.
<i>Ber.</i> Berichte der Deutschen chemischen Gesellschaft.
<i>Bull. de l'Assoc. Ing. Electr.</i> Bulletins de l'Association des Ingenieurs Électriques.
<i>Chem. Zeit.</i> Chemiker Zeitung.
<i>Chem. Trade Journ.</i> Chemical Trade Journal.
<i>Compt. rend.</i> Comptes rendus hebdomadaires des Séances de l'Académie des Sciences.
D.R.P. Deutsches Reichspatent.
<i>Elect. and Met. Ind.</i>	. Electrochemical and Metallurgical Industry.
<i>Electrochem. Ind.</i> Electrochemical Industry.
<i>Electrochem. Review</i>	. Electrochemical Review.
<i>Eng. and Mining Journ.</i>	. Engineering and Mining Journal.
Eng. Pat. English Patent.
Fr. Pat. French Patent.
<i>Int. Cong. App. Chem.</i>	. International Congress of Applied Chemistry.
<i>Journ. Ind. and Eng. Chem.</i>	. Journal of Industrial and Engineering Chemistry.
<i>Journ. pr. Chem.</i> Journal fur praktische Chemie.
<i>Journ. phys. Chem.</i> Journal of Physical Chemistry.
<i>Journ. Soc. Chem. Ind.</i>	. Journal of the Society of Chemical Industry.
<i>Journ. Soc. Dyers and Colorists.</i>	. Journal of the Society of Dyers and Colorists.
<i>Met. and Chem Eng.</i>	. Metallurgical and Chemical Engineering.
<i>Monit. Scient.</i> Moniteur Scientifique de Quesneville.
<i>Trans. Amer. Electrochem.</i>	. Transactions of the American Electrochemical Society.
<i>Trans. Faraday Soc.</i>	. Transactions of the Faraday Society.
U.S. Pat. United States Patent.
<i>Zeitsch. angew. Chem.</i>	. Zeitschrift fur angewandte Chemie.
<i>Zeitsch. anorg. Chem.</i>	. Zeitschrift fur anorganische Chemie.
<i>Zeitsch. Elektrochem.</i>	. Zeitschrift fur Elektrochemie.
<i>Zeitsch. phys. Chem.</i>	. Zeitschrift fur physikalische Chemie.

THE APPLICATIONS OF ELECTROLYSIS IN CHEMICAL INDUSTRY

INTRODUCTION

ELECTROLYSIS is the term given to the process by which a compound is decomposed, when in solution, by the passage through it of an electric current.

The compound is dissolved for this purpose in some liquid medium, usually water, but it is sometimes possible to use the compound alone, in a molten state.

In the early years of the nineteenth century, Humphry Davy and Michael Faraday investigated the subject of electrolysis, and established many useful facts. By 1880, it was realised that the electrolytic decomposition of substances was of industrial importance, and processes were soon devised and patented, in Europe and America, which involved the application of electrolysis in chemical industry.

It is essential to discuss, briefly, the general facts and principles of electrolysis, before passing to a detailed study of the various industrial processes.

When an electric current traverses a solution (a liquid conductor), its passage is accompanied by the decomposition of the substance, whereas an ordinary metal conductor is not decomposed by the passage of electricity through it.

The liquid is termed the electrolyte, and the terminals immersed in it, by which the current enters and leaves, are called the electrodes.

That electrode which is connected to the positive pole of the battery or generator is the *anode*, and the other, which is

connected to the negative pole of the current source, is known as the *cathode*; the current is regarded as entering the electrolyte at the anode and leaving it at the cathode.

By electrolysing an aqueous solution of copper sulphate between platinum electrodes, metallic copper is deposited at the cathode whilst oxygen is evolved at the anode; similarly, the electrolysis of acidified water yields hydrogen at the cathode and oxygen at the anode. Sodium chloride in aqueous solution yields hydrogen at the cathode and chlorine at the anode, but if molten sodium chloride be used, metallic sodium will be deposited on the cathode.

Evidently, secondary reactions take place under certain conditions, because, instead of the expected sodium, hydrogen gas in equivalent amount is produced at the cathode, when water is present, during the electrolysis of sodium chloride. This is due to the chemical reaction of the liberated sodium with the water thus—

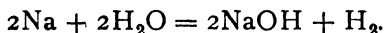

There is also a secondary reaction at the anode in the case of aqueous copper sulphate, for in place of the complex (SO_4), oxygen is obtained, owing to the reaction between (SO_4) and water—



Hydrogen and the metals are liberated at the cathode, whilst oxygen and the non-metallic elements are liberated at the anode.

Probably the current is conveyed or conducted through the solution by the positive and negative components into which the compound is resolved when in the dissolved state.

This idea is due to Faraday (1834), and he termed these carriers of electricity *ions*; those discharged at the cathode are *cathions*, and those discharged at the anode are *anions*. The cathions carry positive charges of electricity, the anions carry negative charges, and when the ions reach their respective electrodes their charges are given up or neutralised, and the substance is liberated or discharged. The ions are denoted by symbols in this manner: H^+ , Na^+ , Cu^+ ; or $\overset{+}{\text{H}}$, $\overset{+}{\text{Na}}$, $\overset{++}{\text{Cu}}$;

which symbols signify that the ions of hydrogen and sodium carry one positive charge, and the copper ion two positive charges. *Anions* are denoted thus: Cl' or Cl; the chlorine ion carries one negative charge.

There is evidence that the substance which conducts the current, when dissolved in water, is not "split up" or dissociated by the energy of the current, but rather, in the solution it exists, to a considerable extent, in the dissociated or ionised condition. Since Joule's Law ($H = I^2rt$) holds for liquid conductors, the energy of the current produces heat in the conductor, and is not used in supplying the disruptive force necessary to decompose the substance. If the ions are already present in the solution owing to the dissociating or ionising influence of the solvent, then, as soon as a difference of potential is set up at the electrodes, the charged ions will travel towards their respective poles. The positively charged ions, for instance, travel to the cathode, which is negative, where they lose their charges and are liberated.

Faraday showed that the quantity of electrolyte decomposed is proportional to the quantity of electricity which passes through it, and he also proved that when a current passes through several electrolytes in series, the different weights of the elements liberated at the electrodes are in the same ratio as the chemical equivalents. Hence, the same amount of electricity is required to discharge one chemical equivalent of any element, and is approximately 96,500 coulombs.

Evidence of the existence of ions, in aqueous solutions, is obtained by measurements of osmotic pressure, and similar evidence results from a study of the lowering of freezing point or elevation of boiling point of aqueous solutions. It is conceivable that in dilute solutions, dissolved substances distribute themselves throughout the solvent as the molecules of a gas distribute themselves by diffusion and fill any space.

Diffusion takes place in liquids, because, if two solutions are placed carefully in contact one above the other, the two layers after a time disappear and the composition of the

liquid is the same throughout. The molecules exert a pressure (osmotic pressure) analogous to gas pressure, and this pressure can be measured by means of apparatus arranged as shown in Fig. 1. A porous pot is fitted with a manometer tube which is fixed in a rubber cork, fitting tightly into the porous pot. The pot is previously provided with a semi-permeable membrane in its wall, by filling it with potassium ferrocyanide, and immersing it in a solution of copper sulphate. Where the solutions meet in the interstices of the pot, a deposit of copper ferrocyanide is formed which allows free passage for water, but not for sugar molecules dissolved in the water.

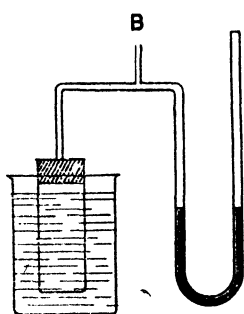

FIG. 1.

If the pot, thus prepared, be filled with concentrated sugar solution, the manometer tube fixed and sealed off at B, and the pot then immersed in a beaker of water, after standing some time a difference of level in the manometer liquid will indicate that pressure is exerted inside the pot.

The pressure is due to the effort of the sugar molecules to get into the water, and so become diluted, just as a gas tends to pass to a vacuum and so reduce its pressure.

The sugar molecules are unable to pass out, therefore dilution is brought about by water passing in, and this continues until the pressure above the liquid in the pot is equal to the pressure in the water outside. The manometer gives a measure of the osmotic pressure of the solution in its diluted state.

J. H. van't Hoff (1887) showed that in dilute solutions, Boyle's Law is true for osmotic pressure as it is for gas pressures. He used Pfeffer's measurements of osmotic pressure to show that the pressure is proportional to concentration.

The following are some measurements made by H. N. Morse (1907)¹—

¹ *Amer. Chem. Journ.*, 1907, 37, 324.

Conc. of Molecules per litre	'1	'2	'3	'4	'5	'6	1'0
Osmotic Pressure in Atmospheres	2'4	4'7	7'0	9'3	11'7	14'1	23'7
Equivalent Gas Pressure	2'2	4'5	6'7	8'9	11'1	13'4	22'3

The figures for the two pressures are parallel.

It has similarly been shown, that in dilute solutions Charles's Law is valid and that osmotic pressure is directly proportional to the absolute temperature.

Avogadro's hypothesis is therefore applicable to dilute solutions, and hence solutions which have the same molecular concentration of solute will have the same osmotic pressure.

Now, passing to consider electrolytes, it is found that many substances give abnormally high pressure values.

Arrhenius determined the number of molecules present in dilute solutions of the following substances, when quantities proportional to the molecular weights were dissolved in water—

<i>Non-conductors</i>	<i>Conductors</i>
Methyl alcohol . 0'94	MgSO ₄ . . . 1'25
Cane sugar . . 1'0	SnCl ₂ . . . 2'69
Ethyl acetate . 0'96	KCl 1'81

The conclusion usually accepted is, that the inorganic substances (salts) are partly ionised or undergo electrolytic dissociation when dissolved.

As already mentioned, the cathions are discharged at the cathode, giving a + charge to the electrode. The opposite exchange is going on at the anode, and the source of current is necessary to maintain the electrodes at a difference of potential so that anions and cathions may be continuously discharged.

Energy is consumed in this work, and not in separating the molecules of solute into two or more parts; possibly the heat of hydration of the ions furnishes the energy necessary for ionisation (see Decomposition Voltage).

ELECTRICAL UNITS

Electrical energy comprises two factors, quantity and intensity, as in water-flow, the quantity is determined by the pressure.

In electrical measurements pressure is often termed potential or electromotive force (E.M.F.).

The quantity of electricity which passes a certain point in a conductor in unit time is the current, and this is analogous to rate of flow of water. The rate is determined by the difference of potential at the ends of the conductor, and by the resistance of the system; the relation between these quantities is known as Ohm's Law, expressed thus: $I = E/R$.

The unit of quantity is the coulomb, that which deposits 0.001118 gm. of silver, and a current carrying one coulomb per second is one ampere. In other words, the ampere is that current which passed through a specified solution of silver nitrate deposits 0.001118 gm. of silver per second.

The solution of silver nitrate is specified thus: It contains 10-20 gms. of silver nitrate in 100 gms. of distilled water; not more than 30 per cent. of the silver may be deposited when the test is running, and the cathode current density must not be greater than 0.2 amp. per cm^2 .

The unit of resistance is the ohm and is equal to the resistance of a column of mercury of 1 mm^2 cross section, having a length of 106.30 cms. and a weight of 14.452 gms. at 0°C .

The unit of E.M.F. is the volt, the pressure necessary to send a current of one ampere through a resistance of one ohm.

The Weston cadmium cell is the usually accepted standard of electromotive force; at 20°C . its potential is 1.0184 volts, and its temperature coefficient is very small.

One faraday of electricity is a quantity equal to 96,500 coulombs, and the passage of this amount of electricity through a cell deposits or liberates one gram-equivalent of an element.

The unit of power is the watt; it is the rate at which energy is expended by an unvarying current of one ampere flowing under a pressure of one volt.

The corresponding unit of energy is the watt-second or

joule, that is, the energy expended in one second, when one ampere flows under a pressure of one volt.

For industrial purposes these units are too small and the following multiples are in use—

The kilowatt = 1000 watts; the horse-power = 746 watts. Corresponding energy units are the kilowatt-hour (K.W.H.) and the horse-power-hour (H.P.H.). The kilowatt-hour is also the Board of Trade unit.

Relations between heat energy and electrical energy which are constantly made use of are, one watt-second or a joule = $\cdot 239$ gram-calorie, therefore one gram-calorie = $4\cdot 189$ joules.

It is possible, by means of these relations, to calculate from the heat of formation of a compound the voltage necessary to decompose it. For example, the heat of formation of one gram-molecule of sodium chloride is 97,690 calories, and this energy is equal to $97,690 \times 4\cdot 19$ joules or volt-coulombs. Now in order to decompose 58.5 gms. of sodium chloride the quantity of electricity required is 96,500 coulombs, and therefore the voltage will be $\frac{97,690 \times 4\cdot 19}{96,500} = 4\cdot 22$ volts.

At its fusion temperature the voltage required will not be so great, because the heat of formation is less, by the quantity needed to raise 58.5 gms. of sodium chloride from 15° to 772° C., the specific heat of the chloride being $\cdot 214$, that is—

$$\text{Heat required} = 58\cdot 5 \times 757 \times \cdot 214 = 9480 \text{ calories}$$

$$\therefore \text{heat of formation} = 97,690 - 9480 = 88,210 \text{ calories.}$$

$$\text{Hence the voltage required will be } \frac{88,210 \times 4\cdot 19}{96,500} = 3\cdot 81.$$

These voltages, calculated from heats of formation, are minimum values not realised in practice, because owing to various conductivity losses they are always exceeded.

DECOMPOSITION VOLTAGE

For the decomposition of every electrolyte a definite E.M.F. must be maintained between the electrodes if the anions and cations are to be continuously separated. When for example, dilute sulphuric acid is electrolysed between

platinum electrodes, a back E.M.F. is developed by the layers of gas which collect on anode and cathode, and this will ultimately reach 1.7 volts, therefore a voltage greater than this must be used if electrolysis is to continue.

The decomposition voltages for a few electrolytes are :
 $\text{ZnSO}_4 = 2.35$; $\text{NiSO}_4 = 2.09$; $\text{Pb}(\text{NO}_3)_2 = 1.52$; $\text{AgNO}_3 = 0.70$. Dilute acids and bases have a decomposition voltage of approximately 1.70 volts, and the products of electrolysis are oxygen and hydrogen.

The greater part of the decomposition voltage needed for continuous electrolysis is utilised in overcoming polarisation effects due to the deposition of gas or metal on the electrodes. During the electrolysis of a dilute solution of acid or alkali between platinum electrodes, hydrogen gas forms a layer on the cathode, and oxygen a layer on the anode, with the result that instead of two platinum plates there are two of different materials, one of oxygen, the other of hydrogen, in dilute acid or alkali, and the arrangement acts like an accumulator, until the gases have passed back again into the solution, giving a current in a direction opposite to that first passed through.

When copper sulphate is electrolysed between copper plates there is no back E.M.F. of polarisation, since the surface of each plate remains unchanged and the energy change at the cathode is compensated by that proceeding at the anode.

The power used in chemical decomposition is obtained in watts by multiplying back E.M.F. by current, that is power = eI watts.

$$\text{For total } I = \frac{E - e}{R} \text{ and power applied} = EI \text{ watts}$$

where E = applied voltage and I = current in amperes.

$$\text{Power spent in heat} = I^2R \text{ watts}$$

$$\text{Power spent in chemical work} = x \text{ watts}$$

$$\text{Then } EI = I^2R + x$$

$$\begin{aligned} \therefore x &= EI - I^2R = EI - \frac{I(E - e)R}{R} \\ &= EI - EI + eI \\ &= eI \text{ watts.} \end{aligned}$$

Overvoltage is another factor which acts against the impressed electromotive force during electrolysis. It is defined as the excess of reverse potential given by an element during its deposition over that given by the pure element in the same electrolyte. Overvoltage plays an important part in electrolytic reduction and oxidation, and will be referred to again. It increases with increase of current density, according to Tafel,¹ and probably that is why the overvoltage of hydrogen at smooth platinum is greater than at platinised platinum. In the former there is less surface and therefore a greater current density.

Overvoltage varies with different electrodes; for hydrogen the values are—

Platinised platinum	'005 volt.
Smooth	'09 "
Nickel	'21 "
Tin	'53 "
Zinc	'70 "
Mercury	'78 "

Electrical Osmosis is the term applied to the transport of the constituents of an electrolyte through a diaphragm when one is used to separate anode from cathode. There is a general movement towards the cathode of ions, dissolved molecules and solvent.

CATAPHORESIS, OR THE TRANSPORT OF COLLOIDS

In a suspension, or colloidal solution, the suspended particles or colloids are transported to one of the electrodes. This has been utilised in the tanning of skins in which the tannin colloid is forced towards the cathode, into the skin which is placed in a position between the two electrodes, and the rate of tanning is accelerated.

The electrical dehydration of peat has been accomplished by placing the air-dried material between a solid anode and a cathode which is perforated; the water is forced through the cathode, which acts as a filter, and a peat can be obtained

¹ *Zeitsch. phys. Chem.*, 1905, 50, 641.

in which the water content has been reduced from 60 per cent. to 25 per cent.

Positive colloids travel to the cathode; such are: $\text{Fe}(\text{OH})_3$, $\text{Zr}(\text{OH})_4$, $\text{Ti}(\text{OH})_4$, $\text{Cd}(\text{OH})_2$, $\text{As}(\text{OH})_3$, $\text{Cr}(\text{OH})_3$, $\text{Ce}(\text{OH})_3$, $\text{Th}(\text{OH})_4$.

Negative colloids which are driven to the anode are: Au, Ag, Ir, Pd, Se, Te, S, $\text{Si}(\text{OH})_4$, molybdic, tungstic, and vanadic acids, sulphides, gums.

Under a pressure of 1 volt, colloidal silver travels 3.5 microns¹ per second. Gelatin and albumen move less quickly.

Hydrogen and hydroxyl ions (acids and bases) influence the direction in which a colloid travels. Albumen moves to the anode in alkaline solution, and to the cathode in acid solution, and it remains indifferent to the current in neutral solution.

INFLUENCE OF COLLOIDS ON ELECTRO-DEPOSITION

It is now a common practice to add colloidal substances to the bath for electro-plating, and in refining metals by electrolysis, in order to improve the nature of the deposited metal. A. G. Betts uses .01 per cent. of gelatin in the fluosilicate method for refining lead, and gelatin is also used in the perchlorate lead process. A smoother and more coherent cathodic coating is obtained than when no gelatin is used.²

It has been suggested that this beneficial action of colloids is due to their reducing action since reducing agents have so often been applied, *e.g.* hydroquinone, resorcinol, aminophenol; but certain oxidising substances act equally well, sodium nitrate and chloride, and also certain inorganic salts which are neither reducers nor oxidisers.

E. B. Spear found that many inorganic salts improved the deposition of copper, and his theory is, that the colloidal particles of copper are dissolved by the addition of a salt which increases the solvent power of the electrolyte for the metal, and so prevents these particles from depositing and keeps the deposit smooth.³

¹ A micron = .001 mm.

² *Met. and Chem. Eng.*, 1912, 10, 298.

³ *Int. Cong. Applied Chem.*, 1912, Xa, 99.

According to Mueller, the colloids are protective and prevent the colloidal metal from falling out of solution at the moment of discharge.¹

CURRENT EFFICIENCY

The minimum amount of electricity needed to produce one gm.-equivalent of any substance is 96,500 coulombs or 26.8 ampere-hours.

In practice, more is needed owing to unavoidable wastage and side reactions.

For example, in the production of chlorine and caustic soda it is possible that oxygen may be evolved instead of chlorine, owing to secondary reactions. In the manufacture of sodium by the Castner process some of the sodium reacts with water which is formed during the electrolysis, and further, some of the discharged sodium dissolves in the fused caustic, travels to the anode by diffusion and is there converted to oxide.

In the manufacture of hydrosulphite of soda, the substance itself is unstable, and decomposes to some extent. In this case the loss is kept down by increasing the current concentration, that is the ratio, current / volume of electrolyte.²

Evidently it is impossible to obtain a current efficiency of 100 per cent. in most processes. The efficiency is given by the ratio, yield actually obtained / yield calculated from Faraday's law.

In copper refining, current efficiency is very high, about 95 per cent. The efficiency in alkali-chlorine cells varies from 50 to 95 per cent., and for the Castner sodium cell it is about 45 per cent.

The energy efficiency must always be taken into account, because it includes not only the current, but voltage also, and it is obtained by multiplying the current efficiency by the ratio, calculated voltage / actual voltage used.

With the electrolysis of aqueous sodium chloride the current efficiency may be 90 per cent. The voltage may be

¹ *Zeitsch. Elektrochem.*, 1906, **12**, 317.

² *Ber.*, 1900, **33**, 2212.

as low as 2.3 volts, but sometimes reaches 4 volts; in the latter case the energy efficiency of the process is $\frac{90 \times 2.3}{4}$
= 51.7 per cent.

THE ELECTROLYSIS BATH

A technical bath can take up to about 6 volts between anode and cathode; higher voltage is liable to produce shunt-current losses and excessive heating.

A number of tanks are generally arranged in series because the current derived from the D.C. dynamo may be at a P.D. of 150 volts, and this must be distributed over the units, so that a pressure of 4 or 5 volts is produced between each pair of electrodes.

It is usual to arrange units in several short series, each series being in parallel with the rest (see Copper Refining), and a generator of low voltage is used. It is then possible to stop a series if any unit goes wrong, without throwing all the units out of work, as would be necessary, for instance, if a generator of 500 volts were used for 100 cells, all in series.

The amount of current which a single cell will take depends upon—

- (1) The working temperature to be maintained.
- (2) Current density to be used.
- (3) Size of the cell.

If a low temperature is to be maintained, a thorough circulation of the electrolyte will be necessary, and the cell will be small; if, however, temperature rise is permissible, then a large cell, taking more current, may be used.

The cells are generally rectangular and almost filled with anodes and cathodes, which alternate and are placed close together to prevent resistance losses. In the parallel system the anodes are connected to a common lead, and likewise the cathodes. Sometimes a bipolar arrangement of electrodes is used, and in this arrangement the two end-electrodes are connected to the source of current, while the intermediate

plates become electrodes by induction, on one side positive, and on the other side negative (see Copper Refining).

Anodes.—These should have a low oxygen and chlorine overvoltage, since these gases are so frequently discharged, and the material must be resistant to attack by chemical action. The substances generally used are platinum, graphite, magnetite, lead peroxide, manganese dioxide and ferrosilicon.¹

When platinum is used, gauze construction is desirable, to diminish cost. Platinum anodes are by no means unattacked by chlorine, but when alloyed with iridium a much more resistant electrode is obtained.² Chlorine overvoltage is particularly low at graphite, and oxygen overvoltage is much lower at nickel and iron than at platinum.

Iron and nickel are very suitable anode materials when oxygen is evolved from an alkaline solution.

Electrodes of manganese dioxide resist oxygen very well in acid solution, as also do Ferchland's lead peroxide anodes ;³ carbon electrodes must be prepared with every care if they are to prove satisfactory.⁴

Cathodes.—These are often of iron or graphite and do not have to stand so much corrosive action as anodes. Copper gauze is the cathode material in the Hargreaves-Bird process for making sodium carbonate. Lead is used for the production of hydrogen and oxygen by the electrolysis of dilute sulphuric acid, and mercury forms the cathode when sodium is deposited in the electrolysis of brine solutions.

Generally, when the liquor is alkaline, iron is utilised, and when acid is used in the electrolyte, graphite forms a suitable cathode.

Both iron and platinum have low hydrogen overvoltage values, hence iron is very useful in alkali-chlorine cells. The overvoltage for hydrogen at lead and mercury is very high, this is an advantage in the mercury cell for soda, where sodium deposition takes place and not hydrogen discharge (q.v.).

Diaphragms are sometimes essential, in order to separate

¹ Eng. Pat., 9079 (1891).

² *Zeitsch. Elektrochem.*, 1902, 8, 149.

³ Eng. Pat., 24806 (1906).

⁴ *Met. and Chem. Eng.*, 1913, 11, 242.

anode and cathode compartments. Asbestos, or some asbestos composition, is very widely used for this purpose, and in acid liquors, aluminium silicate gives good results. Most clays and cements contain too much basic material for them to be used in acid liquors.

THE USE OF MOLTEN ELECTROLYTES

Fused salts are good conductors and, by electrolysis, yield metal at the cathode and chlorine or oxygen at the anode. The chlorides are most suitable for this purpose, $ZnCl_2$, $PbCl_2$, $NaCl$, $CaCl_2$, $MgCl_2$, but fused caustic soda or potash are used with equally satisfactory results. Probably, the ions of the salt or hydroxide are present, but to what extent is not known. The conductivity increases with rise of temperature, and it is of the same order as for aqueous solutions, but higher.

Faraday's laws of electrolysis hold for molten salts and one gram-equivalent of each metal, or radicle, is liberated by 96,500 coulombs.¹

The production of "metal fog," during the electrolysis of fused salts, was first investigated by Lorenz.² If a metal be melted under its fused salt, and the temperature raised, dark clouds of metal rise which dissolve in the molten salt; on cooling, the clouds or fog settle down and re-enter the metal. This sometimes causes a loss of metal during electrolysis if the temperature of the bath is above the melting point of the metal which is being deposited.

The phenomenon is possibly akin to colloidal solution since it can be prevented by the addition of certain neutral salts to the fused mass, and this addition also has the effect of increasing the current efficiency of the process. In the case of magnesium production, by electrolysis of fused carnallite, it has been shown that what was formerly regarded as "metal fog" formation is entirely, or chiefly, due to

¹ *Zeitsch. anorg. Chem.*, 1900, **23**, 255; *Zeitsch. phys. Chem.*, 1903, **42**, 621.

² *Zeitsch. Elektrochem.*, 1907, **13**, 582; *Zeitsch. phys. Chem.*, 1911, **76**, 732; *Trans. Amer. Electrochem.*, 1904, **6**, 160.

the formation of a suboxide¹ of the metal, which must be avoided if the maximum current efficiency is to be maintained.

Lorenz has shown that "metal fog" formation is retarded by the addition of neutral salts to the fused salt, and in the case of lead chloride he made a number of determinations of current efficiency showing that the value is improved considerably by the addition of various neutral salts.

Ferric chloride exerts a deleterious effect on current efficiency² in molten electrolytes.

¹ *Trans. Amer. Electrochem.*, 1915, 27, 509.

² *Zeitsch. anorg. Chem.*, 1903, 36, 36.

CHAPTER I

METHODS OF GENERATING THE CURRENT

Primary Cells.—The first cell, or battery of cells, for generating a current of electricity was invented by Volta in 1800. One form of his battery, the voltaic pile, consisted of a series of alternating zinc and copper discs, each pair being separated from the next by a piece of moist flannel. In another form, the crown of cups, the zinc and copper plates took the form of cups, which fitted into each other, and each pair was separated from the next by a small vessel of similar shape which contained salt water.

Such a battery provided a large current at low voltage or pressure, suitable for electrolysis; by its means Nicholson and Carlisle (1800) succeeded in decomposing water, and, within a few years, other workers electrolysed various salt solutions and produced various metallic deposits upon the negative electrode. Prior to this invention of Volta, the frictional electric machine was the only means of producing electricity, but such high-voltage electricity was unsuitable for electrolysis; produced at high voltage it could not be used for current, but only gave a sudden disruptive discharge.

Following the discovery of Volta's cell, many primary cells were devised, involving the same principle, but designed to overcome its chief defects: such were Daniell's Cell, 1836; Grove's Cell, 1839; Bunsen Cell, 1843; Leclanché Cell, 1868.

These are termed primary cells because they can be used as a primary source of current, but at the present time their use is restricted to intermittent work such as telephones, electric bells, and the ignition of gaseous mixtures in gas engines. A brief description will be given of those in present-day use, but it must be remembered that they are not used

for electrolytic work because none of them gives a regular and continuous current for very long, and further, the cost of working with such cells, in electrolysis, is excessively high. A Board of Trade unit of electrical energy (the kilowatt-hour) can be obtained from power stations at one penny or less, whereas the cost of generating the same amount of energy from a Daniell cell would be about tenpence, and from a Leclanché cell the cost would be about eightpence.

Daniell's Cell.—A simple voltaic cell consists of a zinc and a copper plate partly immersed in dilute sulphuric acid contained in a glass vessel. The difference of potential between the two plates is about 1·08 volts, and on joining the unimmersed portions of the plates by a copper wire a current of electricity is obtained, flowing from copper to zinc; bubbles of hydrogen gas are evolved from the copper plate while the zinc plate is rapidly corroded. The energy of the cell is supplied by the chemical reaction—

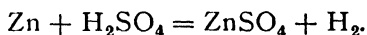

After a short time, the current given by the simple cell diminishes, and ultimately, almost ceases; this is due to the bubbles of hydrogen gas collecting on the copper plate, which produce considerable resistance, and moreover, give rise to a back electromotive force.

This phenomenon is known as polarisation. In Daniell's cell, polarisation is removed by dividing the cell into two parts by means of a porous pot and using concentrated copper sulphate solution in the outer part of the cell in which the copper plate is immersed. The zinc is immersed, as before, in sulphuric acid solution contained in the porous pot, and, to prevent the zinc from becoming corroded (local action) except when current is passing, it is *amalgamated* by rubbing over with mercury.

The chemical reaction supplying the electrical energy is $\text{CuSO}_4 + \text{Zn} = \text{ZnSO}_4 + \text{Cu}$, and polarisation is avoided by depositing copper, instead of hydrogen, on the copper plate. The E.M.F. of the cell is 1·07 volts.

Leclanché Cell.—In this cell, a carbon rod forms the

positive element, packed around with manganese dioxide to overcome polarisation. The carbon and manganese dioxide are contained in a sealed porous pot, and this pot stands in a glass vessel which contains ammonium chloride solution in which a zinc rod is immersed. In this cell, any hydrogen evolved at the carbon pole is oxidised by the solid manganese dioxide, and in this way, polarisation is kept down sufficiently to render the Leclanché cell valuable for intermittent work.¹ Its voltage on open circuit is 1·4 to 1·5 volts, but it drops rapidly, when the circuit is closed, to 1·1 or 1·2 volts whilst the normal current of 0·1 to 0·2 ampere is flowing.

The various "dry cells" on the market are modified forms of the Leclanché, in which pastes are used instead of dilute solutions, and the top of each cell is sealed with pitch, except for a vent-hole to allow the escape of gas from the carbon pole. The porous pot is not needed, and the zinc rod is replaced by a cylinder of that metal which generally forms the outer case of the cell.

Lelande Cell.—This cell was invented in 1883. There are two zinc plates, and between them a copper oxide plate which acts as the positive and also as a depolariser; these plates are immersed in caustic soda solution and, before use, the surface of the copper oxide is reduced to metallic copper.

There are two or three varieties of the original cell which are very efficient. The "Neotherm" cell is of this type, it weighs 12 lb. and will give 150 ampere-hours if discharged at the one-ampere rate, the electromotive force is 0·9 to 0·6 volt when in use. The Edison-Lelande is another much-used form.

The energy of all primary cells is supplied at the expense of the chemicals which must be replenished; they are, relatively, very expensive sources of current, but, prior to the invention of the dynamo, they furnished the only source of current suitable for electrolysis.

Fuel Cells.—Since only 15 per cent. of the heat energy of

¹ Polarisation in Leclanché cells, *Trans. Amer. Electrochem.*, 1915, 27, 155.

carbon is transformed into mechanical energy in the steam engine, and not more than 25 per cent. in the gas engine, many attempts have been made to construct an electrolytic fuel-cell in which the reaction $C + O_2 = CO_2$ would be so utilised that nearly all the heat energy might be transformed into electrical energy. Such a cell should give a voltage of 1.05 volts with oxygen (1.04 volts with air), and the oxidation of 1 kgm. of carbon would give about 9000 amp.-hours.

Such a cell must consist of a carbon anode and an oxygen cathode separated by a suitable electrolyte;¹ if the carbon and oxygen are in direct contact, local action will take place and no current will be produced.

The chief difficulties in realising such a cell are: first, carbon will not ionise; second, the common forms of carbon are not pure and therefore fouling of the electrolyte will take place; third, there is the difficulty of making an oxygen electrode.

A great deal of ingenuity and thought have been expended on this problem, but the solution of it seems, at present, beyond reach.

Secondary Cells.—The lead accumulator is the most important representative of this class of cells, in which the chemicals used up during discharge can be regenerated by passing a reverse current from some other source, usually a dynamo.

If two lead plates be used as electrodes in a bath of dilute sulphuric acid, the positive lead will become oxidised, on the surface, to PbO_2 by the oxygen which is discharged during electrolysis. At the negative lead, hydrogen gas is evolved and the lead will remain in its original condition.

After conducting this electrolysis for some time (charging), on disconnecting the charging source and joining the two plates through a voltmeter, a P.D. will be noticed, of about 2 volts, flowing from the positive PbO_2 plate to the negative lead plate; the hydrogen evolved on the PbO_2 surface, will reduce it to spongy lead, while the SO_4 ion, liberated on the

¹ *Zeitsch. Elektrochem.* 1894, 1, 122

other plate, will attack it, forming PbSO_4 . The "forming" of the plates is generally conducted after the manner introduced by Planté, alternate charging in opposite directions, by which means each plate becomes coated with a spongy layer of lead

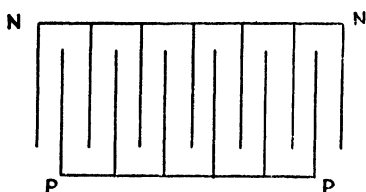

FIG. 2.

which is easily converted to PbO_2 , or readily attacked by the SO_4 ion.

In an ordinary accumulator there are many plates, say six positives PP, and seven negatives NN, arranged as indicated, in Fig. 2, to give

a maximum of surface, and at the same time a minimum of resistance.

During discharge, the anode or positive plate becomes superficially converted into PbSO_4 according to the following reactions—

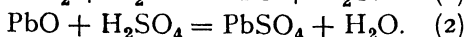
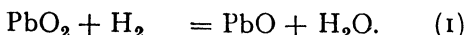

The cathode plate of lead becomes also coated with sulphate by the following changes—

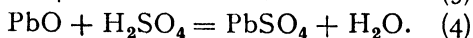
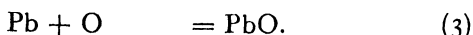

To avoid the lengthy process of "forming" the plates, Faure, in 1888, devised the plan of packing or coating the surfaces of the plates with red lead, which on being immersed in the acid is changed as follows—

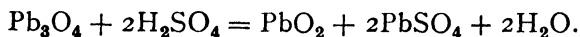

During "charge" the positive, already rich in PbO_2 , has its sulphate changed thus—

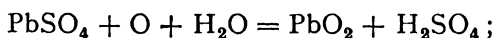

while at the negative, the peroxide and lead sulphate are reduced to lead—

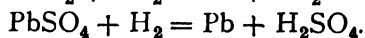
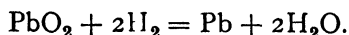

The reactions during discharge are those described above, (1) to (4), and it is evident that the acid becomes more dilute, while during the "charge" reactions, the acid is re-formed and therefore becomes more concentrated. When fully charged the acid has a density of 1.205 to 1.215, and when discharged the density is between 1.17 and 1.19.

It is usual now, to make up the cells with Planté-formed positives and pasted negatives, so that heavy discharge may take place without risk of disintegrating the positive plates.

The chemical reactions taking place in the lead accumulator during "charge" and "discharge" are represented by the following equation—

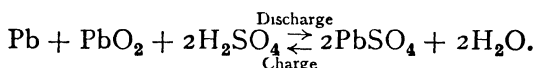

The rapid "formation" of accumulator plates is often carried out by adding a catalyst to the sulphuric acid. This added substance takes many forms, namely, perchlorate, chlorate, nitrate, sulphite or acetic acid.¹ If the anion ratio, concentration of SO_4 / concentration of added anion, be not too great, the PbSO_4 is formed a very short distance from the plate and not actually *on* the plate, so that the surface-formed sulphate is thereby rendered more granular. The same principle has been applied to the electrolytic deposition of white lead (q.v.)

The plates being very close together, it is necessary to ensure separation and guard against short circuiting by fixing glass, ebonite, or wood separators between them. The nest of plates is contained in a vessel of glass, ebonite, or wood lined with thin sheet lead. The capacity of an accumulator is measured in ampere-hours, and, on an average, a cell gives 3 to 6 amp.-hours per kgm. of lead (2 to 3 amp.-hours per lb.).

The maximum discharge rate (always marked on the cell by the maker) should not be exceeded, and a cell should never be further discharged once its voltage has fallen to 1.85 volts.

Accumulators are generally used as a source of current

¹ *Zeitsch. Elektrochem.*, 1909, 15, 872 ; 1911, 17, 554.

in electro-chemical laboratories and for experimental work ; from 85 to 90 per cent. of the amp.-hours put in may be obtained from them on discharge, but usually, not more than 80 per cent. They constitute a valuable means of storing electrical energy which, by the way, is not stored as such, but as chemical energy which can be transformed into electrical energy as required. They are not used for large-scale electro-chemical work on account of their expense and the care needed for keeping them efficient. The dynamo is the only current generator used for industrial work.

Thermopiles.—These are used to a very limited extent as a current source, and depend for their working on the genera-

tion of a current of electricity by the heating of a junction of two different metals.

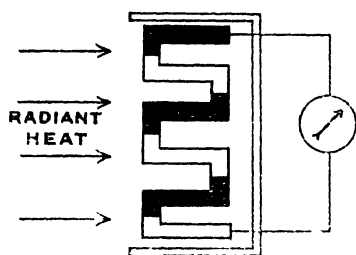

FIG. 3.

To produce any appreciable current, several junctions must be connected in series (Fig. 3) and the best results are obtained with junctions of antimony and bismuth.

One set of junctions being heated and the others kept cool, a thermo-electric current is produced and continues as long as the difference in temperature between the two sets is maintained, and the current increases as the difference in temperature is made greater. By the use of several hundreds or thousands of junctions, it is possible to produce a thermopile, such as that of Gulcher or Clamond, capable of furnishing current for electrolysis. This is evidently a machine for directly converting heat into electrical energy, but since only about 1 per cent. of the energy supplied is converted into electrical energy it is decidedly uneconomical.

A thermopile such as that shown in Fig. 4 has fifty elements, costs about £12, and gives 3 amps. at a pressure of 3 volts.

In the Clamond thermopile the elements were iron and a zinc-antimony alloy, and with several thousands of such junc-

tions (6000) heated by coke, an electromotive force of over 100 volts was obtained. This thermopile is now obsolete, the Gulcher type being the only one employed to any extent.

The Dynamo.—The first magneto-electric machine was constructed by Faraday in 1831, and a few years later, in 1840, Woolrich of Birmingham started the manufacture of these machines, but they were not sufficiently developed to give large and regular currents until 1867. Since that time the dynamo (dynamo-electric machine) has been utilised as the chief source of current for industrial electro-chemistry.

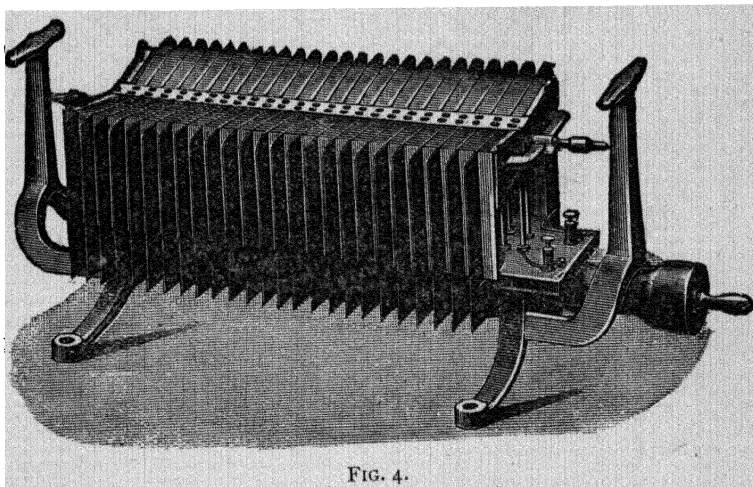

FIG. 4.

The dynamo used by Elkington at his copper refining works, in 1869, attracted considerable attention as a triumph of electrical engineering, and during 1870-72, Gramme introduced important improvements in the construction of dynamo-armatures which greatly improved their efficiency.

The principle of the machine is that of a coil of wire rotating in a magnetic field so as to cut the lines of magnetic force. If a coil ABCD (Fig. 5) be rotated between the poles of a magnet NS, a current is generated in the coil, and if AB is rising, the current will follow the direction indicated by the arrows. When AB has reached its highest position, that is when the plane of the coil is vertical, the rate of change of

lines of force will be zero and consequently the induced E.M.F. will be zero ; then, as AB descends and CD ascends, the current induced will flow in an opposite direction, so that as the coil rotates a change in the direction of current takes place during each revolution. Such a current is alternating, and in order to take it from the machine, slip rings are used (Fig. 6) which rotate on the same axis as the coil, whilst a copper brush, resting on each ring, leads the current to or from the external circuit. In order to convert this alternating current (A.C.) into direct current (D.C.) the split ring commutator is used (Fig. 7).

The two halves of the ring are separated by insulating material, but rotate on the same axis as the coil ; the ends

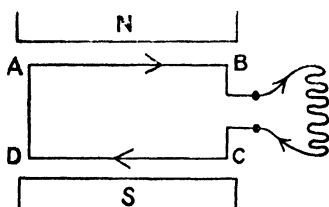

FIG. 5.

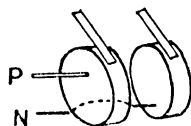

FIG. 6.

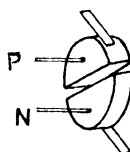

FIG. 7.

of the coil terminate on the ring, one end on each half, and the brushes are so arranged that the top brush, say, always collects current from the rising side of the coil. In this way the external circuit is furnished with direct or continuous current.

The E.M.F. is proportional to the speed of rotation of the coil (armature), to the number of turns in the coil, and to the magnitude of the flux in which it turns ; an armature therefore consists of many turns, and it is wound on a core made up of soft iron stampings in order to provide an easy path for the flux. The Gramme ring armature is shown in Fig. 8, which depicts the manner in which several coils are wound on an iron core, and the manner in which the commutator xy , consisting of a number of copper bars insulated from each other, conveys the current to the brushes. With a single coil the current fluctuates, but as the number of coils

increases the current becomes more steady. Fig. 8 also shows the manner in which the field magnet is excited by the current from the machine itself (series wound), and if the coil rotates in a clockwise direction the current in the circuit will take the direction indicated by the arrows. The drum armature is the form now generally used, the coils being wound on the periphery of a core of soft iron stampings, and a study of Fig. 9 will show that this follows, more or less, the form of the single coil first described. Each coil is wrapped round the drum, and the ends are fixed to

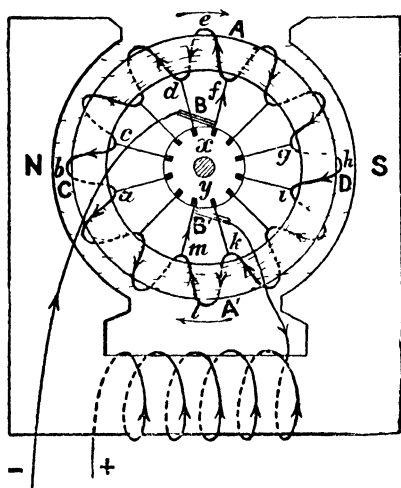

FIG. 8.

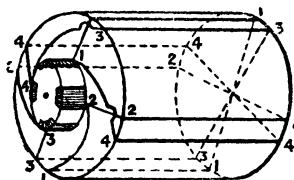

FIG. 9

the commutator. The E.M.F. from a series wound machine rises with the current taken from the machine, and as it is necessary, for ordinary work, that a dynamo shall give as constant an E.M.F. as possible, machines are now either *shunt wound* (Fig. 10) or *compound wound* (Fig. 11). In a shunt winding the pressure falls with an increase of load in the external circuit, that is with a reduction of resistance, because then less current traverses the shunt to produce the magnetic field, so that by combining shunt and series windings in the right proportion a machine is produced which gives a practically constant E.M.F. at all loads.

The above is a very brief description of dynamo construction, and for full information a book dealing with the subject must be consulted.

Rotary Converter.—This is a dynamo constructed on the principle of the single coil arrangement, but, with slip rings at one end of the armature to receive alternating current (from, say, a municipal supply), and a commutator at the other end from which direct current can be collected. The machine is driven by A.C., but delivers or generates D.C.

One of these machines, by the British Thomson-Houston Company, is shown in Fig. 12. This 500 K.W. converter is used in a large soap and alkali works for electrolytic work. The photograph depicts the A.C. and D.C. ends of the

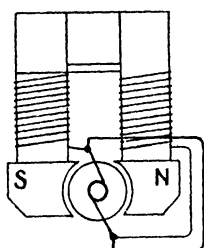

FIG. 10.

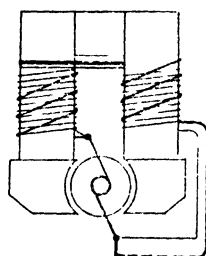

FIG. 11.

machine, and the electrolytically operated induction regulator, seen on the base-plate in the foreground, serves to control the voltage. The range of voltage is not great, the main purpose of the converter being to convert the A.C. supply into D.C. for electrolytic work at a voltage which is not capable of any great variation. For example, with a 3-phase machine, the ratio of D.C. to A.C. is—

$$\frac{2\sqrt{2}}{\sqrt{3}} \text{ to } 1,$$

that is, the voltage of the D.C. is approximately 1.7 times that of the A.C.

In the figure, A is a small motor for starting up the machine, at B are shown the slip rings at the A.C. end, C

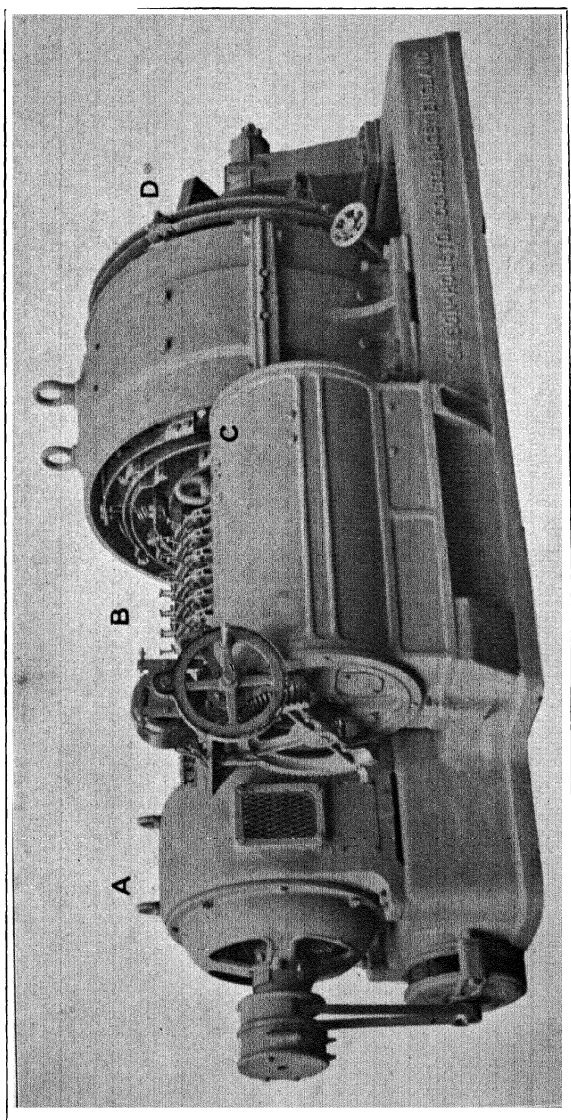

FIG. 12 — Rotary Converter

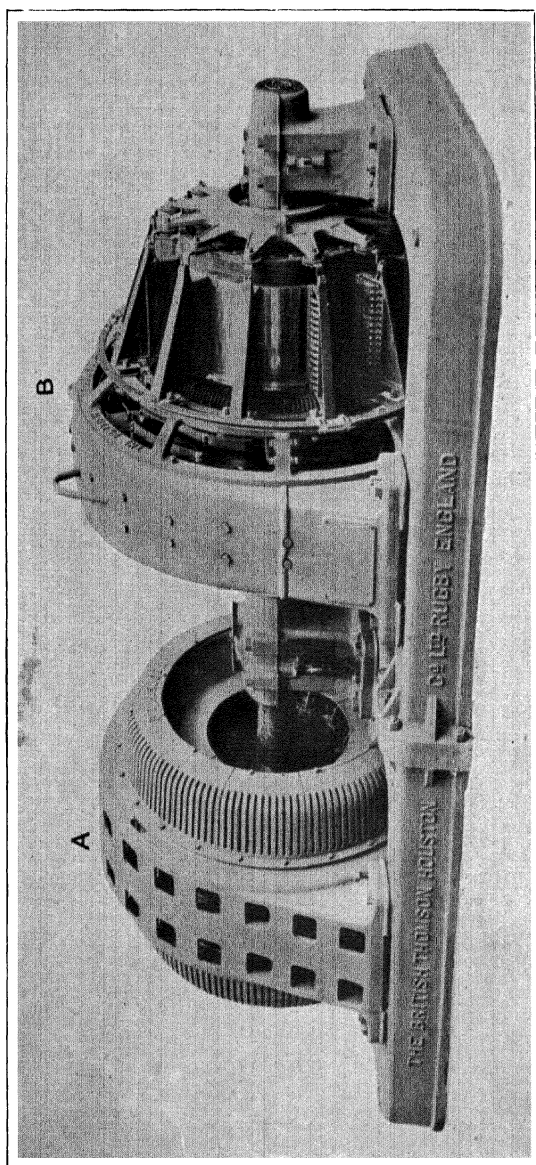

FIG. 12A.—Motor Generator.

is the induction regulator by means of which a 30 per cent. variation in the voltage can be obtained. D is the D.C. end of the machine and one of the brush-holders for collecting the current from the commutator is just visible.

Motor Generator.—A motor is similar in construction to a generator, but receives current which causes it to rotate, and it may then be utilised for driving machinery. It may be used to drive a dynamo, and such a combination is utilised when it is desired to reduce the voltage on supply for electrolytic work. The motor may be a D.C. or A.C. machine driven, for example, at 250 volts, and this in turn drives a dynamo which gives current at perhaps 5 volts, and when motor and dynamo are on the same shaft, the arrangement becomes a motor generator. The generator of Fig. 12a is used by a company engaged in the electrolytic refining of zinc. The motor A driving the machine, is wound for a primary voltage of 11,000 volts and is constructed for alternating current. The generator B delivers direct current at 220 volts, and the brush and commutator arrangement for collecting heavy current is clearly indicated in the figure.

One more matter should receive notice : When a current, developed at a waterfall, is to be transmitted to a station several miles distant, the waste of energy converted into heat in the conducting wires may be considerable. The energy generated at the source will be EI where E represents voltage and I the current, and the heat produced in the wire will be equal to I^2R . The object is therefore to make I^2R as small as possible. One way is to reduce the resistance of the wires (R), but to make conductors of greater diameter involves an increase in the cost of metal ; the other method is to reduce the current, and since the energy in watts is represented by EI , it is obvious that if I is reduced, E the voltage, must be correspondingly increased. This is not convenient with direct current, but with alternating current it is possible to raise and lower the pressure by means of transformers, based on the principle of Fig. 13. An alternating current, produced at the source, is transmitted to the primary

coil of few turns, and it leaves the secondary coil, of many turns, at increased voltage, because

$$\frac{\text{Pressure in Primary}}{\text{Pressure in Secondary}} = \frac{\text{Number of turns in Primary}}{\text{Number of turns in Secondary}}$$

The fluctuating current in the primary coil produces fluctuating flux in the iron core, which in turn produces current in the secondary.

After leaving this step-up transformer, the current is transmitted to the station at perhaps several thousand volts, and before entering the station, where contact with such a current would be fatal, it is transformed down to a convenient and safe pressure by a step-down transformer with many primary turns, and few secondary turns. If required for electrolytic work, the A.C. is converted into D.C. by a rotary converter

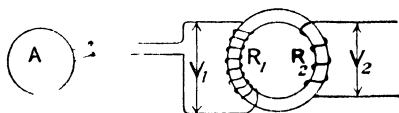

FIG. 13.

or a motor generator. Fig. 13 represents the process of transforming down from an A.C. generator A.

Measurement of the Current.—Two kinds of meters are in use for the measurement of electrical quantities. The ammeter for measuring current strength, and the voltmeter for measuring the potential difference between two points in a circuit. In electro-chemical work it is essential to know, in every process, what current is being used, and at what pressure it is being delivered. The principles of these two instruments are the same. Their construction depends on—

(1) The electromagnetic effects produced on a small piece of iron moving in a coil through which the current passes (moving iron instruments), or the rotating effect on a coil of wire moving in a magnetic field (moving coil instruments).

(2) The heating effect of the current (hot wire instruments). The calibration of these instruments will not be discussed here as it involves a description of the scientific

basis on which the various means of measuring electrical quantities rests; such a description is beyond the scope of this book, and for full information on the matter a text-book on the subject must be consulted. However, the essential difference between ammeters and voltmeters should be understood. The former are usually low-resistance instruments, while the latter (voltmeters) are high-resistance instruments.

All the current passes through the ammeter, and waste of energy will result if the resistance of the instrument is appreciable ($W = I^2R$), and the current through the circuit will be reduced since $I = \frac{E}{R}$.

For example, if the current used be 100 amps., and the resistance of the ammeter be .1 ohm, the power wasted will be $100^2 \times .1 = 1000$ watts, but if the resistance be only .001 ohm the power wasted is only $100^2 \times .001 = 10$ watts.

In using a voltmeter to measure the pressure between two points of a circuit or between the terminals of an electrolysis bath, only a small portion of the current is shunted through the instrument, otherwise considerable waste of power will take place.

For example, if a voltmeter be placed across a circuit where there is a P.D. of 100 volts, if the resistance of the instrument be 200 ohms, the current taken by it (E/R) will be .5 amp., and the power used (I^2R) will be 50 watts.

If, however, the instrument has a resistance of 10,000 ohms the current taken (E/R) will be .01 amp., and the power consumed will be 1 watt only.

POWER AND ELECTRO-CHEMICAL INDUSTRY

The energy needed for chemical manufacture by electrolysis is obtained from a dynamo or motor-generator; it was the invention of the dynamo, in 1867, which rendered the progress of electro-chemical industry possible.

To drive the dynamo, a source of power is necessary, and cheap power is essential, in many chemical industries, if electrolytic processes are to compete successfully with purely chemical methods. The power sources available are: water

power, steam power and gas power, and the cheapest of these is water power. Consequently, electro-chemical industries flourish in those districts where such power is available.

Niagara affords the most striking example of successful water-power development, the Norwegian waterfalls have been utilised to a considerable extent, and on the Continent, especially in the neighbourhood of the Alps and the Pyrenees, electro-chemical industries avail themselves of cheap water power.

There are only two important water powers in the United Kingdom: one is at Foyers, in Scotland, where the British Aluminium Company utilise the fall from the river Foyers to Loch Ness, and obtain a fall of 350 ft. for working the turbines; the other power is at Askeaton, in Ireland, where carbide is made.

Special circumstances may cause the power cost to occupy a position of secondary importance.

For example, in the refining of copper or precious metals, the cost of power is relatively a small item, of minor importance compared with the market value of the products obtained.

Aluminium and sodium can be prepared successfully only by electrolytic processes, therefore the cost of power need not receive such close attention in these two cases as it must in the production of electrolytic chlorine and soda, where the industry enters into competition with well-established chemical processes.

The cost of upkeep of a water power installation is comparatively small, and the cost is largely dependent upon initial capital outlay which, on an average, works out at £10 per H.P. installed. By allowing 15 per cent. for interest and depreciation, and 15s. as working expenses per H.P. year, the annual cost of a horse-power is about 45s. The supply at Niagara varies from £2 to £4 per H.P. year.

The cost of steam power in this country is between £5 and £8 per H.P. year, and when the cost exceeds the latter figure it is uneconomic for most electro-chemical industries.

Gas power occupies a more favourable position, and with

producer gas the cost varies from £3 to £3 10s. per H.P. year. The load-factor of power for electro-chemical work is high (90 per cent.), and this implies cheaper power than is usually obtained from municipal supplies, where the load factor is usually not more than 50 per cent., and sometimes as low as 20 per cent. when much of the machinery is only in use during the early night hours for lighting purposes.

The cost of electrical energy depends on fuel, operating expenses and plant-upkeep, rents, interest, royalties and depreciation; interest and depreciation are generally taken together as about 10 per cent. of cost of construction. In a paper by E. A. Ashcroft¹ on this subject, the following values are given for different power sources per H.P. year—

Water power, £1 10s. to £4 (Niagara average, £3 10s.; Sault Ste. Marie, £2; Norway, £1); gas engine power, £5 5s.; oil engine power, £5 8s.; steam power, £6 9s. 6d. The author is a strong advocate of water power, but in the discussion which followed it was maintained that steam power was to be obtained often at less than £5 per H.P. year, that is about $\frac{1}{4}d.$ per B.O.T. unit.

In a discussion on power costs in this country, D. B. Kershaw² quoted the cost of generating electricity by steam at $\cdot 32d.$ to $\cdot 64d.$ per K.W.H.

The ideal price set down by Professor Donnan was $\cdot 1d.$ per unit, by means of producer gas plant, with recovery for sulphate and tar. This low price of electric power is certainly something to be aimed at in this country, but at present $\cdot 25d.$ per unit is considered very low.

The cost in electrolytic work of converting from high to low pressure will often have to be taken into account when a public supply is used. For example, with a motor and generator each having an efficiency of 80 per cent., the combined efficiency will be 64 per cent., so that the actual cost of the power will be one and a half times as great as the supply company's charges.

In a copper refining or electro-chemical works, running

¹ *Trans. Faraday Soc.*, 1908, **4**, 134.

² *Journ. Soc. Chem. Ind.*, 1913, **32**, 994.

day and night, the load factor would be high, and cost would probably be about *·5d.* per unit, on an average.

With coal at *4s.* to *5s.* per ton, with day and night running, the cost per unit would probably be in the neighbourhood of *·25d.*

Although in the United Kingdom there are no important water power sources, this must not be regarded as fatal to the development of electro-chemical industry. Coal is abundant, and by the scientific and economic use of it there seems no reason why cheap electric power should not be obtained, comparing favourably, as regards price, with water power.

Cheaper power can certainly be obtained by the erection of large central power stations near the coal-fields; such stations would supply the surrounding districts with power as is already done, in one or two cases, in the north of England.

The utilisation of blast furnace gases, for generating electric power on a large scale, would certainly provide very cheap power.¹

LITERATURE

Several articles on Electro-chemistry and Electro-metallurgy, *Electrical Review*, 1901 to 1902, by J. B. Kershaw.

A review of Electro-chemical Industry, by J. Swan, *Journ. Soc. Chem. Ind.*, 1901, **20**, 663.

Niagara as an Electro chemical Centre, J. W. Richards, *Electrochem. Ind.*, 1902, **1**, 11, 49.

Technical Electro-chemistry in Russia, *Trans. Faraday Soc.*, 1908, **4**, 74.

Some Electro-chemical Centres, J. N. Pring, 1908.

Electro-chemical War Supplies, *Met. and Chem Eng.*, 1916, **14**, 259.

Electro-chemical Possibilities of Pacific Coast States, *Met and Chem. Eng.*, 1916, **15**, 18, 279.

¹ See *Coal and its Scientific Use*, by Professor Bone in this series of monographs.

CHAPTER II

ELECTROLYTIC REFINING OF METALS

COPPER

THE refining of crude copper by electrolysis was first carried out, on a commercial scale, by Elkington at Pembrey in South Wales, in 1869. The idea of refining copper and other metals by electrolysis originated with Charles Watt of Kennington, who, in 1851, was granted a patent (13755) for refining various metals and also for producing metals from their ores by similar means.

The method was early recognised as being well suited for the production of very pure copper, and the development of the industry has been greatly accelerated, since 1890, by the increasing demand for high-grade copper for electrical work. Though several attempts have been made since 1885 to produce the metal from its ores by electrolysis, little success has been attained, and crude copper is therefore generally obtained by the ordinary metallurgical methods, and the product, which varies in purity between 97 and 99 per cent., is cast into slabs suitable for the refining tanks.

The greater part of the World's refined copper is produced in America, but a considerable quantity is turned out in the United Kingdom and on the Continent. The original refinery of Elkington is now worked by Elliot's Metal Company, whose output, prior to 1914, was about 7000 tons per annum. There are big refineries worked by Messrs. T. Bolton & Sons at Froghall, Staffs., and also at Widnes, which produced in 1914 about 10,000 tons of refined metal per year.

In principle, the process is the same at all refineries, but it differs in certain details. The crude copper is cast into slabs (the anodes), about 3 ft. long, 20 in. wide, and $\frac{3}{4}$ in. to $1\frac{1}{2}$ in.

thick, which are suspended in a suitable vat where they alternate with pure sheet cathodes of electrolytic copper. The bath or vat contains, as electrolyte, a solution of copper sulphate acidified with sulphuric acid, and the passage of the current transfers the copper from anode to cathode, while the impurities either dissolve and remain in the electrolyte, or fall to the bottom beneath the anode where they accumulate, forming the anode slimes or sludge. It is essential for successful refining that the crude copper shall be of good quality, not less than 97 per cent. copper. On an average, anode copper contains 98 per cent. of this metal and the remaining 2 per cent. consists of arsenic, lead, bismuth, iron, zinc, tin and sulphur. The cathode copper, that is, the refined metal generally contains 99.93 to 99.98 per cent. pure metal.

Some analyses of English anode copper are given below—

	Cu.	Ag.	Au.	Pb	Bi.	As.	Sb	Fe	Ni.	S.	O.
I.	98.60	.05	0	.10	.05	.80	.10	.10	.10	.10	—
II.	98.24	.10	.003	.02	.04	.94	.40	—	.28	.03	.05
III.	96.35	.20	0	1.19	05	.08	.10	.61	—	.69	.70

Generally, crude copper contains about 30 oz. of silver per ton, and $\frac{1}{16}$ oz. of gold.

An American copper containing more than the usual amounts of gold and silver, analysed as follows—

Cu 99.25, Ag .338, Au .001, As .033, Sb .054, Pb .009, Bi .002, Ni .002, S and Te .008, Oxygen .30.

This metal contained about 60 oz. of silver per ton and $\frac{1}{4}$ oz. of gold. The fact that the amounts of arsenic, antimony and bismuth are low, is probably due to its production in the converter whereby these elements are converted into volatile oxides. A few thousandths per cent. of these three impurities, it is stated, have a marked bad effect on the conductivity of the metal.

Two systems of refining are in use, known respectively as

the multiple system and the series system. The difference denoted by the names, is shown diagrammatically in Figs. 14 and 15. In the multiple system, which is most widely used, anodes and cathodes alternate, the anodes are attached to a common lead, that is in parallel, and the cathodes of pure copper, about $\frac{1}{20}$ in. thick, are likewise attached to a common negative lead (Fig. 14).

The vats are made of wood and lead-lined. They have a capacity of 9 ft. \times 3 ft. \times 3 ft., and each one takes about 22 anodes and 23 cathodes, each plate being separated from the next by about 2 in.

The size of the vats must not be greater, on account of the difficulty of obtaining efficient circulation of the electrolyte in very large vessels. The voltage applied to each vat is

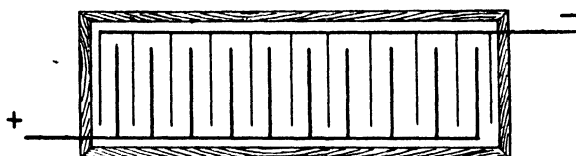

FIG. 14.

about .3 volt with an average current of 4000 amps. Several hundreds of these vats (units) are connected in series and driven from one generator, the current density (I.D.) is generally about 10 amps. per ft². and sometimes is as high as 20 amps. per ft²., but if too high, warty masses of copper tend to grow across from cathode to anode and produce a short circuit.

The multiple system is very adaptable and is certainly preferred for general practice, but the series system is used in some large American refineries, *i. e.* Nichol's Refinery, Brooklyn, and at the Baltimore refinery. In the series (or Hayden system) each tank is filled with anode slabs which act as bipolar electrodes. On one side pure copper is deposited and on the other side crude copper is removed (Fig. 15).

Each unit carries a smaller current than in the multiple system but at a much higher voltage (17 volts). The tanks are larger, 16 ft. \times 5 ft. \times 5 ft., and they are made of slate,

since lead-lined vats would allow leakage of current (at 17 volts), which would escape *via* the lining, and current would thus tend to pass from end anode to end cathode; no copper would then be deposited on intermediate cathodes. It is always found, under ordinary conditions, that more metal is deposited on the end cathode than on the intermediate ones.

The anode copper must be high grade for the series system so that the anodes may dissolve regularly, and this is further assisted by rolling and hammering. Each unit contains about 150 bipolar electrodes, placed 1 to 2 cm. apart, each being 6 to 8 mm. thick, and these being thinner than

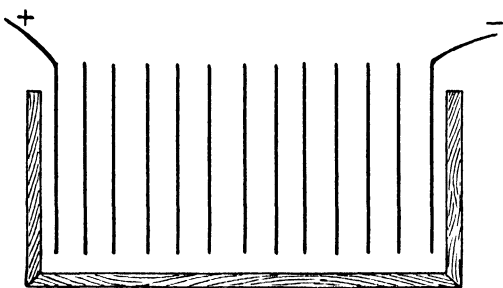

FIG. 15.

multiple anodes, remain in the bath for a shorter time, only about 12 days, as compared with 20–24 days.

The current density used in the series system is high, about 2 amps. per dm^2 . (18 amps. per ft^2 .) and hence it is necessary to circulate the liquor more rapidly and to regenerate it more frequently than in the parallel system.

Some advantages of the series system are that for a given copper output a smaller plant is needed and less electrolyte, and less copper is locked up for a given annual output. As the electrodes are closer together, the temperature is maintained more efficiently at about 50°C .

The current efficiency of the multiple system is approximately 96 per cent. compared with 90 per cent. for the series system, but the voltage drop between each pair of electrodes in the former system is nearly twice as great as in the latter,

·25 volt compared with ·13 volt ; hence the multiple system requires $\frac{.90}{.06} \times \frac{.25}{.13} = 1.8$ times as much energy. One ton of refined copper, by the multiple system, requires the expenditure of 300 K.W.H., and by the series system about 150 K.W.H.

Although the series system shows a great saving in energy over the multiple system, and although less metal is "locked up" in this process, its successful working is dependent upon a regular supply of high-grade anode material of fairly constant composition. This may not be available, and then the cost of preliminary treatment, to prepare anodes of the desired quality will probably prove too expensive. The multiple system has the great advantage of being more adaptable, that is it can deal with low-grade copper and also with copper containing extra large quantities of silver or gold.¹

The American vats are usually larger than those used in Europe. They are always supported on insulators of glass or porcelain and arranged so that any leakage of liquor can be quickly detected. The electrodes are suspended either by lugs resting on busbars and the opposite side of the tank, or they are suspended by hooks to crossbars. The latter method means economy of anode, as the "remainder," which has to be re-cast, when the rest of the anode is used up, is reduced from about 20 per cent. to 8 per cent.

Some idea of the scale of working and of the costs involved may be obtained from the following statement: A copper refining plant using 1000 H.P. per year has a turnover of about 15,000 tons. The market value of this is approximately £800,000, and about one-twelfth of this is permanently "locked up" (about £67,000 worth), so that the interest charge on this will be about £3350, hence the need for driving the voltage as high as possible to increase the turnover.

Whichever system is used, it is necessary to circulate the electrolyte and to renovate it at intervals. Circulation is necessary to prevent impoverishment of the copper in the neighbourhood of the cathode, and renovation prevents too

¹ *Eng. and Mining Journ.*, 1916, 101, 9.

great an accumulation of impurities in the electrolyte and their consequent deposition on the cathode.

The upper limit to current density (I.D.) is set by the amount of impurities present in the anodes, since the higher the I.D. the greater tendency is there for the impurities to be carried to the cathode.

Some form of gravity circulation is generally adopted (see Fig. 16), and the rate of flow is governed by the current density used. At Anaconda, where the current density is 10 amps. per ft², the rate is three gallons per minute, whilst at Great Falls, where a current density of as much as 40 amps. per ft². is used, the rate is six gallons per minute.

The current density is made as high as possible for speed,

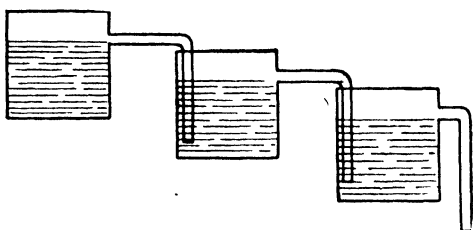

FIG. 16.

but if too high, hydrogen may be evolved at the cathode, spongy copper deposited and even cuprous oxide. Too high a current density also tends to dissolve the silver which should go into the anode slimes.

In the Norddeutsche Affinerie, the I.D. is about .4 to .5 amp. per dm². (3.6 to 4.5 amps. per ft²), and in America, using very pure anodes, it goes up to 4 amps. per dm². (36-40 amps. per ft²). The average I.D. is 1-2 amps. per dm². (10-20 amps. per ft²).

As regards the electrolyte, a high copper content is desirable, to keep down the deposition of impurities on the cathode and to give a coherent deposit of copper; on the other hand, it must not be sufficiently concentrated to permit crystallisation of copper sulphate on the anode. Usually, about 16 per cent. of $\text{CuSO}_4 \cdot 5\text{H}_2\text{O}$ is present, and 6-10 per

cent. of sulphuric acid. The acid increases the conductivity, and prevents the precipitation of cuprous oxide, but if present in too great quantity it reduces the solubility of the copper sulphate, and causes liberation of hydrogen at the cathode.

Small amounts of sodium chloride, magnesium chloride, or hydrochloric acid are sometimes added, to facilitate the precipitation of antimony, bismuth, and silver in the sludge. Arsenic is so weakly basic that even in an acid solution its cathodic deposition is not serious. The addition of a soluble chloride causes the removal of antimony and bismuth as insoluble oxychlorides.

The process is continuously controlled by determinations of the acidity, copper content, and conductivity. The average temperature is 40°; a higher temperature means increased conductivity but tends to produce cuprous oxide.

The sludge contains silver and gold as well as lead sulphate. Most of the antimony, tin, and bismuth go to the sludge direct, but to some extent these metals dissolve, forming unstable sulphates which are hydrolysed, and the basic sulphates so formed go to the sludge.

Arsenic, iron and nickel dissolve in and contaminate the electrolyte, whilst cuprous oxide is partly dissolved and has the bad effect of neutralising some of the free sulphuric acid; most of it, however, goes into the sludge.

If the anodes are much below 98 per cent. purity they dissolve irregularly and disintegrate, and the electrolyte requires more frequent renewal to prevent it becoming foul.

The chief ingredients of the sludge are generally silver, copper, lead and antimony, but other elements are present as may be shown by a typical analysis of sludge—

Cu 11.01	Ag 53.9	Au .29	Pb .91
Bi .93	Sb 6.25	As 2.11	Se .39
Te 1.17	SO ₄ 5.27	H ₂ O 2.38	

Analyses showing the difference between refined and anode copper are given below¹—

¹ *Zeitsch. Elektrochem.*, 1903, 9, 387.

<i>Unrefined</i>		<i>Refined</i>	
Cu 99'25	Pb '009	Cu 99'925	
Ag '24-'34	Ni '002	Ag '001	
As '02-'03	Au '001	As '001	
Sb '007	Pt '009	Sb '001	
Fe '01	S,Se,Te '008	Bi '0001	
Bi '003	Oxygen '3	Pt '0025	
		Oxygen '007	

Analysis of a foul electrolyte (per litre) : Cu 51'80, Fe 13'20
As 14'0, Sb '62, H₂SO₄ 48'0.

A slime from Anaconda contained the following : Ag 55'15
Au '2, Cu 13'8, SO₄ 10'68, Pb, Bi, Sb, As 8'35.

These slimes are usually worked up by digesting with hot sulphuric acid while air is blown through the liquor to promote the solution of copper, arsenic, antimony and bismuth. The undissolved portion consists chiefly of lead, gold and silver, and is cupelled after the addition of fresh lead.¹

Selenium and tellurium, if present, are removed by fluxing the residue with carbonate and nitrate of soda. The residual silver-gold alloy is subsequently cast into anodes for parting by electrolysis.

Foul electrolytes are often regenerated by evaporation and removal of the copper sulphate (bluestone) which crystallises out. After a second evaporation, the liquor is passed over scrap iron to remove any copper remaining in solution.

At Great Falls refinery, the market for bluestone having failed in 1899, the process is now adopted of electrolysing the foul liquor with lead anodes, so that most of the copper is deposited in a pure state ;² or the electrolysis is allowed to proceed until not only copper, but arsenic and antimony also, are deposited, and the solution is then run into crystallising tanks where the sulphates of iron, nickel, bismuth and zinc separate. The resulting liquor, which is returned to the cells, contains per litre, 1100 gms. H₂SO₄, As '1, Sb '2, Fe 1, Ni 5'3, Zn 1'5 grms.

¹ *Met. and Chem. Eng.*, 1911, 9, 417.

² *Met. and Chem. Eng.*, 1911, 9, 154 ; 1913, 11, 509.

A scheme has been devised by A. G. Betts,¹ and tested experimentally, for fractionally depositing the metals present in the slimes resulting from copper and lead refining.

In 1892 the World's output of electrolytic copper was 32,000 tons, and in 1902 it amounted to 278,900 tons. In the last-named period, the quantity of silver produced was 27,000,000 oz., together with 346,000 oz. of gold, both of these collected from the anode slimes produced during the refining of the copper. The cost of refining in 1892 was about £4 per ton, and at the present time it is about 16s. per ton.

In 1915 the production of copper, in America alone, was about 647,000 tons (*Eng. and Mining Journ.*, 1916, 101, 9).

The following papers contain interesting particulars of copper refining practice—

Copper Refining at Great Falls and Anaconda, *Electrochem. Ind.*, 1903, 1, 416.

Electrolytic Copper Refining, D. Bancroft, *Trans. Amer. Electrochem.*, 1903, 4, 55.

Electrolytic Refining of Composite Metals (in which a number of patents are quoted for separating copper and nickel), T. Ulke, *Eng. and Mining Journ.*, 1897, 114; *Trans. Amer. Electrochem.*, 1902, 1, 95.

Modern Electrolytic Copper Refining, T. Ulke, *Trans. Amer. Electrochem.*, 1903, 3, 119.

LEAD REFINING

The refining of lead by electrolysis has been carried on during the last twenty years, and after varying success this method of refining the metal has become firmly established. Commercial lead, produced by the process of Parkes or Pattinson, attains a high degree of purity (99.98 per cent.), so that electrolytic refining can only become a commercial possibility if a considerable saving of cost is proved. The amount of silver present seldom exceeds .01 per cent. (less than 4 oz. per ton), and it should be remembered that one of the objects of electrolytic refining is the recovery of precious metals, together with bismuth, antimony and copper.

The high chemical equivalent of lead is a point in favour of electro-deposition, one faraday of electricity (96,500

¹ *Electrochem. Ind.*, 1905, 3, 141.

coulombs) deposits 103·5 gms. of lead as compared with 31·5 gms. of copper.

Much pioneering work has been carried out in America, and considerable progress is due to A. G. Betts, whose process is widely used at the present time.

The methods which have been used, or are now in use, are as follows:—

Keith's Process was used in New York for several years. The crude lead anodes were suspended in a solution of lead sulphate in sodium acetate, and each anode was encased in a muslin bag which served to catch the anode slime. The anodes had a composition approximately as follows:—

Pb 96·4, Sb 1·08, As 1·20, Cu ·29, Ag ·54, Zn, Fe, etc., ·49.

The process was unable to compete with Parkes's process, and its working was discontinued.

Tommasi Process.¹—The electrolyte in this case is lead acetate in aqueous sodium or potassium acetate.

Two anodes of crude lead are suspended in the bath, and between them, a thin disc of copper or aluminium bronze, which forms the cathode, is rotated; the spongy lead which collects on the rotating cathode is removed by scrapers as it revolves. Some lead peroxide is always formed on the anodes which causes a back E.M.F., and hence increases the voltage required for continuous working. It is uncertain to what extent this process has been used on a large scale.

Another process proposed depends upon the electrolysis of fused lead oxychloride at about 500° C. The oxychloride contains a certain proportion of sodium or potassium chloride, and the cell devised by Borchers for carrying out the process is shown in Fig. 17. The cell, which is of iron, is divided into anode and cathode compartments by the insulated partition P. The fused anode lead is fed in on the positive side, where it runs down to B, and after being dissolved, is transferred by the current to the negative side of the cell and collects as refined lead at A.

¹ *Practical Electro-chemistry*, B. Blount, 1906, p. 89.

The fluosilicate process, invented by A. G. Betts,¹ for refining lead has met with considerable success since it was introduced in 1902.

It is now used in America and in England. At the Canadian Smelting Works, Trail, B.C., each tank gives 750 lb. of lead per day with 4000 amps. at .5 volt per tank.

The electrolyte is a solution of lead silicofluoride in aqueous silicofluoric acid (H_2SiF_6), and the lead salt is produced by the action of aqueous silicofluoric acid upon white lead,

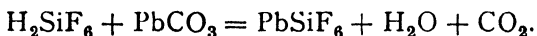

The 35 per cent. hydrofluoric acid, obtained from fluor spar and vitriol, is allowed to trickle over quartz, and the

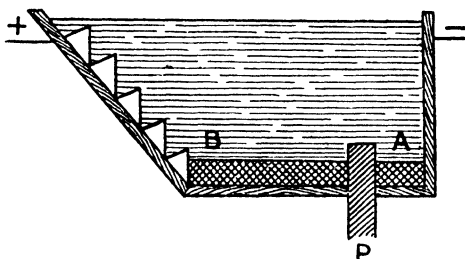

FIG. 17.

solution from this tank, containing H_2SiF_6 , then passes to another tank where white lead is added; the electrolyte contains 70-80 gms. of lead as $PbSiF_6$, and 100 gms. of H_2SiF_6 in the litre.

The anodes of crude lead are 3 ft. \times 2 ft. \times 1 in. thick, and alternate with pure sheet lead cathodes $\frac{1}{8}$ in. thick. Each tank holds 22 anodes and 23 cathodes, the tanks are of wood, lined with asphalt, twenty-eight in series, 86 in. \times 30 in. \times 42 in. deep, and the working temperature is 30-35° C.

The anodes dissolve in about 8 to 10 days, and their average composition is Pb 98.0, Ag .62, Sb .6, Cu .24, As .20, Bi .10, Sn, Fe, Au .05.

¹ U.S. Pat. 713277 (1902). *Electrochem. Ind.*, 1903, 1, 407.

The electrolyte contains 400–500 gms. of gelatine for each thousand kgs. of lead deposited. Betts found this addition of gelatine greatly improved the deposit and prevented the growth of lead crystals from cathode to anode. He mentions in his patent other substances than gelatine, namely, resorcinol, hydroquinone, sulphurous acid, and *ortho*-aminophenol, and he ascribes their value to their reducing action (see p. 10).

The amount of lead refined per day in one works is between sixty and one hundred tons, at an average cost of 16s. per ton, which is practically the same as the cost of refining copper. The current density required is .9 to 1 amp. per dm^2 , and there is a small loss of H_2SiF_6 , which amounts to between three and five pounds per 1,000 lb. of lead refined.

The refined metal has an average purity of 99.996 per cent.

*Perchlorate Process.*¹—In this process, worked by Siemens and Halske, the electrolyte is an aqueous solution of lead perchlorate $\text{Pb}(\text{ClO}_4)_2$, formed by the action of aqueous perchloric acid upon white lead; the current density is 2 to 3 amps. per dm^2 . Very good deposits are obtained from this bath, and it is recommended for electro-plating with lead.

TIN REFINING

Formerly the stripping of tin-plate was the only practical application of the separation of pure tin from other metals, and Goldschmidt's process has been much used for this purpose.

The scrap iron is packed in large iron baskets or cages which are made the anodes; each basket holds 10–20 kgs. (20–40 lb.) of scrap, and six of them are suspended in each tank, which has a capacity of 3 cubic metres and contains 10 per cent. caustic soda. The temperature is maintained at about 70° C., and the cathode current density is 1 amp. per dm^2 ; the tin so obtained has a purity of about 98 per cent., with 2 per cent. of iron and lead. Probably, the de-tinning

¹ *Trans. Amer. Electrochem.*, 1910, 17, 261; D.R.P., 223668 (1910).

of scrap iron will be accomplished entirely by the chlorination process, which seems likely to replace the electrolytic process of Goldschmidt in the future.

The "stripping" of metals by electrolysis is of some importance. For example, it is applied to the removal of brass from bicycle frames.¹

Tin is at present refined by electrolysis at Perth Amboy, N.J., by the American Smelting and Refining Co. The crude metal is obtained from Bolivian ores, and considerable progress in refining has taken place recently.²

IRON REFINING

Pure iron is in demand for use in transformer cores and for experimental alloy work.

At Leipzig it is produced by Langbein and Pfanhauser, who use the Fischer process.

The electrolyte is a solution of ferrous chloride and calcium chloride; the working temperature is 90° C. and current density 10 amps. per dm². The metal has an average purity of 99.95 per cent.; one of the best samples gave the following result on analysis: Fe 99.986, S .008, P .007.

According to the German patent 126839, Merck uses a solution of ferrous chloride at 70° C.

CADMIUM

This metal is refined on a small scale by electrolysis, using platinum cathodes. Solutions of the fluoride, fluosilicate and fluoborate give good deposits.³

ANTIMONY

Many attempts have been made to produce pure antimony from solutions in acid or in alkaline sulphide. The chief difficulty is to produce a deposit free from arsenic, and, according to Addicks, many methods have been tried at the Raritan Copper Works, without success.⁴

¹ *Electrochem. Ind.*, 1904, 2, 8.

² *Met. and Chem. Eng.*, 1917, 16, 9.

³ *Trans. Amer. Electrochem.*, 1914, 25, 297, 319.

⁴ *Trans. Amer. Electrochem.*, 1915, 28, 325.

SILVER REFINING

The refining of silver and gold are closely associated, since most of the materials brought to the refinery contain both metals.

Such materials are: crude gold bullion containing about 30 per cent. gold and 60 per cent. silver; silver-gold alloy, obtained from the slimes of the copper refinery, which contains about 95 per cent. silver, 3 per cent. gold, together with 2 per cent. of copper, bismuth, lead, tellurium and platinum; slimes from electrolytic lead refining, or the rich silver-lead alloy which results from desilverising lead, and which contains about 94–98 per cent. silver, with gold .5 per cent., and copper, bismuth, lead 1.5 per cent.; scrap jewellery and old plate, which may contain as much as 50 per cent. of copper.

The older method of parting gold and silver by nitric or sulphuric acid has now been superseded almost completely by electrolysis.

For refining silver, some modification of the original method of B. Moebius (1884) is used, in which crude silver anodes are suspended in a bath of silver nitrate solution containing nitric acid.¹

The silver dissolved from the anodes is deposited on pure cathodes and the copper remains in solution, but must not accumulate beyond a 4 per cent. concentration, otherwise it will be deposited on the cathode.

The vats are made of earthenware or of pitch pine lined inside with tar, the dimensions being usually about 12 ft. × 2 ft. × 2 ft. Cathodes and anodes alternate, and the anodes are sometimes encased in cotton bags which catch the slimes of gold and platinum. The deposited silver has often a crystalline structure and tends to grow across to the anode; to prevent this, some mechanical device is introduced by which the cathode surfaces can be scraped at intervals, and the loose silver then drops to the bottom of the tank.

In a later form of cell, Moebius² made use of a cathode

¹ *The Mineral Industry*, 1894, 3, 189; 1895, 4, 351; *Trans. Amer. Electrochem.*, 1905, 8, 125.

² Eng. Pat. 532209 (1895).

which takes the form of an endless travelling band of silver or silver-faced rubber; from this band the silver is scraped by an endless band-conveyor which carries the deposited silver upwards and tips it into a receiving box.

At the Philadelphia Mint, the Moebius process is used with vertical electrodes, which give complete satisfaction if a certain amount of gelatine be added to the bath. This renders the deposited silver quite coherent, so that there is no necessity to resort to the horizontal cathode, and mechanical scraping is unnecessary, since the silver deposit is firm.

Gold, platinum and tellurium are unattacked, and fall into the slimes as the anode dissolves away; the slimes also contain PbO_2 , together with tin and bismuth as basic salts. If the gold content is above 30 per cent., the anodes retain their original form after the silver has dissolved and passed to the cathode.

The electrolyte has approximately the following composition per litre: silver 1 gm., copper 40 gms., nitric acid 12 gm., and to keep the bath efficient a certain proportion of the contents must be drawn off and replaced at intervals by a fresh solution containing silver nitrate and nitric acid.

The anodes are about $\frac{3}{8}$ in. thick, and remain in the bath 36–48 hours. The amount of silver deposited per K.W.H. is about 2.3 kgs. and the current density used is 7.5–20 amps. per ft². (0.8–2 amps. per dm²).

The following is a brief account of the procedure adopted at the Philadelphia Mint for bullion refining.¹ The anode material contains 30 per cent. gold and 60 per cent. silver, with 10 per cent. copper, bismuth, lead and zinc. The electrolyte contains 3–4 per cent. silver nitrate and 1.5 per cent. nitric acid, with one part of gelatine per 10,000 parts of electrolyte, and I.D. is .75 amps. per dm², at a pressure of 1 volt.

The anodes are $7\frac{1}{4}$ in. long, $2\frac{1}{2}$ in. wide, $\frac{3}{8}$ in. thick, the earthenware tanks used are 40 in. \times 20 in. \times 11 in., and about 40 cathodes, consisting of silver strips .016 in. thick, go to each tank, eight of which make a series. The deposited

¹ *Electrochem. Ind.*, 1906, 4, 306.

silver is crystalline but firm and coherent owing to the presence of gelatine in the electrolyte.

The anodes retain a small quantity of silver which is extracted with nitric acid, and the gold is then melted down.

The Moebius process is used at Pinos Altos for parting silver-gold bullion from Mexican ores.¹

*Balbach-Thum Process.*²—This process is used at two large American refineries, the Raritan Copper Works and the Balbach Works, Newark. The electrolyte contains 4 per cent. of silver nitrate and 1–2 per cent. of nitric acid, and the solution is electrolysed with a I.D. of 5·5 amps. per dm². at the anode, and 2–2·5 amps. at the cathode; the voltage required is about 3·5 volts per cell. Each cell consists of a shallow dish of porcelain (Fig. 18) lined with carbon plates

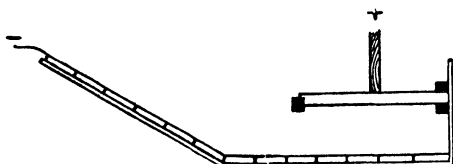

FIG. 18.

which form the cathode; the anode is supported over the cathode in a frame, so that, as electrolysis proceeds, a deposit of silver collects on the floor of the cell, beneath the anode.

At the Raritan Works the anode slimes from the copper refinery are boiled with sulphuric acid, and some nitrate of soda added to accelerate the solution of the copper as sulphate. When this solution has been filtered, the slimes contain 8–18 per cent. of copper and 40–50 per cent. of silver; they are then melted down on the furnace hearth, and air is blown over the molten mass till the silver-gold content reaches 98 to 99 per cent. Anodes are cast from this product and refined in the Balbach-Thum cell. At this works the electrodes are slightly inclined to the horizontal, to assist the mixing of solutions of high density formed at the surface of the anode. Three cells are connected in parallel, each anode

¹ *Eng. and Mining Journ.*, 1891, 51, 556.

² *Electrochem. Ind.*, 1908, 6, 277. U.S. Pat., 58035.

surface is about 3.5 ft²., and the I.D. used is 40 amps. per ft².

*The Dietzel Process.*¹—In this process, the anode of silver-rich alloy is dissolved by nitric acid in the anode compartment of the cell, and the silver is removed from the solution by passing it through a separate vessel containing copper turnings; after this, the liquor, rich in copper, passes into the cathode compartment of the cell where the copper is deposited on rotating cathode drums.

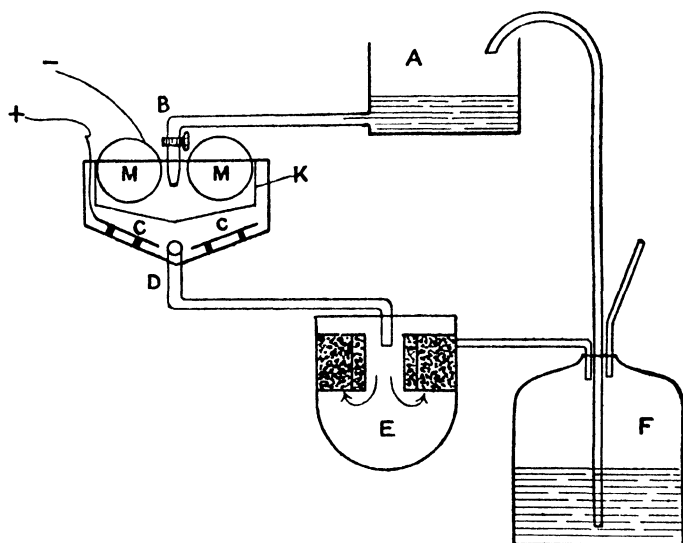

FIG. 19.

By reference to Fig. 19, the course followed by the liquor can be traced. The two rotating drums MM, serve as cathodes, and the liquid entering the cell at B gives up most of its copper before passing through the diaphragm K to the anode compartment where the silver anodes CC are mounted on glass or porcelain insulators. Silver, copper and base metals dissolve, gold and platinum are not attacked. The liquor leaves by the pipe D and flows into the vessel E which contains scrap copper; here it deposits its silver and

¹ *Zeitsch. Elektrochem.*, 1899, 5, 81.

flows over to the pressure vessel F, from which it is pumped up to A, whence it flows to the cathode compartment of the cell.

REFINING OF GOLD

The anode material generally contains about 95 per cent. of gold and 5 per cent. of silver, with small amounts of base metals. Such, for example, is the composition of the anodes left after refining a silver-gold bullion, and if the original bullion contain as much as 30 per cent. of gold, the anodes remaining when the silver has been removed retain their original form and can be immediately used for gold refining.

The process used is due to Dr. Emil Wohlwill¹ of the Norddeutsche Affinerie, Hamburg, and the rights to use the process were purchased by the Philadelphia Mint in 1901.²

The electrolyte is 2-10 per cent. hydrochloric acid containing 2.5 to 6 per cent. of gold chloride, and the temperature used is 60-70° C. Current density varies with the silver content and must be lower as the amount of silver increases; in other words, the purer the gold anode the higher the I.D. that can be used. The maximum I.D., with anodes containing 10 per cent. of silver, is 7.5 amps. per dm², but it is generally less, about 6.5 amps. with a silver content of 5 per cent.; anodes must be periodically scraped to remove the silver chloride which coats them.

The essential part of Wohlwill's patent is the addition of hydrochloric acid to the neutral gold chloride, to prevent chlorine evolution which always takes place when gold anodes are used in neutral gold chloride solution. This chlorine evolution is objectionable and it represents waste, since it should dissolve gold from the anode when working properly.

Wohlwill found that hydrochloric acid represses chlorine evolution and increases the dissolution of the gold anode. His experiments were started in 1874, and ultimately he established the following facts—

¹ *Electrochem. Ind.*, 1903, 1, 157; 1904, 2, 221, 261.

² U.S. Pat., 625863, 625864.

- (1) He proved the suppression of chlorine by addition of hydrochloric acid.
- (2) For a given solution there is a maximum current density above which chlorine evolution commences, but by augmenting the amount of hydrochloric acid or by increasing the temperature this I.D. can be exceeded with safety.
- (3) A pure platinum anode is not attacked in gold chloride acidified with hydrochloric acid, and chlorine is evolved, but, if alloyed with gold, the platinum dissolves.

The Wohlwill process was slower at first than the older chemical method of solution in *aqua regia* and subsequent precipitation of gold by ferrous chloride, but increasing the amount of acid allowed the use of higher current density and considerable speeding up was possible.

The plant at the Philadelphia Mint consists of a 5 H.P. dynamo furnishing 100 to 600 amps. at 6 volts. The cells are of porcelain 15 in. \times 11 in. \times 8 in., and seven such cells are run in series. Each cell contains 12 anodes and 13 cathodes in multiple; the anodes are 6 in. \times 3 in. \times $\frac{1}{2}$ in. thick, and fine gold cathodes, $\frac{1}{16}$ in. thick, are placed between the anodes and $1\frac{1}{2}$ in. from them; the usual temperature is 50–55° C. In 1903 the amount of gold refined per week was 5000 oz. with the expenditure of 1 H.P.

When the solution becomes sufficiently rich in platinum, the gold is precipitated by sulphurous acid, and the platinum as $(\text{NH}_4)_2\text{PtCl}_6$ by the addition of ammonium chloride.

The limitations of the process, according to D. K. Tuttle, are: If the silver exceeds 5 per cent. it will not fall into the slimes as AgCl , but will adhere to the anodes and must be removed at intervals, and secondly, if the amount of copper be excessive the electrolyte requires very frequent renewal.

The kind of gold worked at Philadelphia is Hong Kong gold; 975 Au, 20 Ag, .5 Pt, .5 Ir.

Klondike gold: 776–834 Au, 161–219 Ag.

Bullion of less than 940 fineness is not worked alone but

blended with a better grade. The refined gold has a fineness of 999·8.

The Wohlwill process was improved, in 1908, by the introduction of alternating current.¹

An alternating current of rather greater (r.m.s.)² value is superimposed upon the direct current, and this allows a considerable increase in I.D. and quicker deposition.

With 10 per cent. silver content, the I.D. can be raised to 12·5 amps. per dm². if an A.C. which is 1·1 times as great as the D.C. be used, and if the ratio AC/DC be raised to 1·6, anodes with 20 per cent. of silver can be treated with the same current density. Much higher I.D. can be used with anodes containing a normal amount of silver (5 per cent.).

The slimes consist almost entirely of silver chloride since gold only goes to the slimes, in this process, during the early stage of the electrolysis. An A.C. dynamo and a D.C. dynamo are used in series, and a good deposit of gold is obtained even in the cold, whereas with D.C. only, it is always necessary to heat the solution to avoid the formation of a dark brown or black gold deposit.

The Cyanide Process (Siemens and Halske Process).³—This process is used for recovering gold from very dilute solutions in cyanide (3 to 10 gms. per cubic metre), lead cathodes are generally employed. The process is much used in South Africa.

LITERATURE

Note on the Electro-metallurgy of Gold, W. H. Walker, *Trans. Amer. Electrochem.*, 1903, **4**, 47.

Electrolysis by an Alternating Current, J. W. Richards, *Trans. Amer. Electrochem.*, 1902, **1**, 221.

Precious Metal Refining at the Geneva Refinery, *Met. and Chem. Eng.*, 1909, **7**, 109; 1914, **12**, 441.

The Electrolytic Precipitation of Gold, Silver and Copper from Cyanide Solutions, C. H. Clevenger, *Met. and Chem. Eng.*, 1915, **13**, 852.

The Refining of Silver and Gold, *Met. and Chem. Eng.*, 1911, **9**, 443.

¹ *Zeitsch. Elektrochem.*, 1910, **16**, 25; *Met. and Chem. Eng.*, 1910, **8**, 82; *Electrochem. and Met. Ind.*, 1908, **6**, 450. D.R.P., 207555.

² Root mean square. The A.C. ammeter reading gives the *virtual value*, that is, the maximum value divided by $\sqrt{2}$.

³ *Electrochem. Ind.*, 1903, **1**, 484; 1906, **4**, 297.

CHAPTER III

THE ELECTROLYTIC WINNING OF METALS

MANY attempts have been made since 1880 to obtain certain metals from their ores by electrolysis.

In the processes adopted, the ore is either dissolved in some suitable solvent (generally a salt of the metal to be extracted plays an important part) or, on the other hand, the ore of the metal is made the anode in a suitable bath.

In the latter case the chief metal will be transferred from anode to cathode in the same way that copper is transferred, in the refining process, from crude copper anodes.

Sometimes a fused salt of the metal is used as electrolyte ; this is decomposed and the metal discharged at the cathode.

Considerable success has been achieved in those cases where the metals could formerly be obtained only with difficulty by chemical methods, *e.g.* aluminium, sodium, and the alkaline earth metals calcium and magnesium.

A moderate amount of success has attended the efforts made to obtain zinc, lead, nickel and copper by this means.

ALUMINIUM

This metal has been produced in rapidly increasing quantities since 1888 by the electrolysis of alumina in fused cryolite. Prior to the establishment of this method it was obtained in small quantities by Deville's process (action of sodium on aluminium chloride), and sold at about 16s. per oz. The new process caused the price to fall, in twenty years, from 50s. to about 1s. 6d. per lb. Pioneering work in this field was carried out, simultaneously and independently, by C. M. Hall in America, and by P. Héroult in France, between 1886 and 1889. Both workers found that when a solution of alumina in fused cryolite is electrolysed, the metal

is deposited at the cathode and oxygen is liberated at the anode.

The bath at present used is a 15–20 per cent. solution of purified alumina in molten cryolite (Na_3AlF_6) which is contained in a carbon-lined iron tank, and the electrolysis is carried out at a temperature of 900–1000° C. This temperature is derived from the energy of the current, and the carbon lining protects the iron of the tank which forms the cathode (Fig. 20). The carbon anodes are clamped together in rows and dip well into the molten salt, but, of course, must not touch the fused aluminium which collects at the bottom.

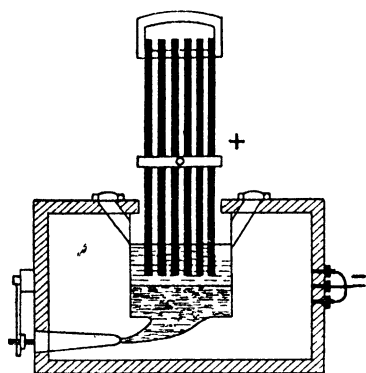

FIG. 20.

Since the melting point of the metal is 665° it remains in a fluid condition, and can be tapped out at intervals. Oxygen which is liberated at the anodes combines with the carbon, to form carbon monoxide, so that the anodes must be renewed somewhat frequently. The voltage required is about 5.5 volts and each unit carries about 10,000 amps., with a current density at the cathode of 100 amps. per ft².; at the anode the I.D. is often as high as 500 amps. per ft². The diagram (Fig. 20) shows a section through one of the cells used by the British Aluminium Company at Foyers, N.B., where the industry was started in 1898. The alumina is decomposed during the process and must be charged into the bath continuously, but there is no great loss of cryolite since this acts only as a solvent. The original cell of C. M. Hall¹ was a carbon-lined iron box 6 ft. × 3 ft. × 3 ft., into which four rows of carbon rods dipped. They were 3 in. in diameter, 15 in. to 18 in. long, and there were forty or fifty of them in each cell.

¹ *Zeitsch. Elektrochem.*, 1903, 9, 347, 360; *Electrochem. Ind.*, 1903, 1, 158.

Charcoal is thrown on to the surface of the molten electrolyte to prevent loss of heat by radiation and to protect the anodes from corrosion by air at the surface.

Since 1888 the metal has been produced in large quantities, in Switzerland at Neuhausen, in France at Froges and St. Michel, in America at Niagara, as well as in Scotland at Foyers.

The pure Al_2O_3 which is required is prepared from Bauxite by the Bayer process (1887), which is conducted by dissolving the crude Al_2O_3 in caustic soda and then allowing the solution to stand in contact with fresh hydrated alumina; 70 per cent. of the Al_2O_3 is precipitated in this way and, after filtering, it is ignited to convert the hydroxide into oxide. The melting point of cryolite is 1000°C ., and this is lowered to 915° by the addition of 5 per cent. of alumina, but according to F. R. Pyne¹ the addition of 20 per cent. Al_2O_3 raises the melting point to 1015°C .

Another important point is, that although solid aluminium is less dense than solid cryolite, the values for density are reversed when the substances are in a molten state, aluminium being denser and therefore sinking to the bottom of a bath of fused cryolite.

The following determinations illustrate this important fact—²

Substance.	Density.	
	Solid.	Molten.
Aluminium	2·66	2·54
Cryolite	2·92	2·08
Cryolite saturated with Al_2O_3	2·90	2·35

The anodes must be of good quality and not easily fractured, since they have to stand a very high current density (500 amps. per ft^2). Those used by the British Aluminium Company are made from petroleum coke. The coke is taken from shale retorts, calcined to remove volatile matter, then

¹ *Trans. Amer. Electrochem.*, 1906, 10, 63.

² *Zeitsch. Elektrochem.*, 1894, 1, 367.

ground up and mixed with binding material, and the moulded blocks are then kilned in a producer gas kiln.¹

For every pound of metal separated there is a loss of one-half to three-quarters of a pound of anode carbon by oxidation, an amount equivalent to that required by the equation—



The reason that only alumina is decomposed by the current, and not cryolite, is, that the decomposition voltage of alumina is considerably lower than that of cryolite, as is shown by the following values—

NaF 4·7 volts, AlF_3 4·0 volts, Al_2O_3 2·8 volts.

Alumina is therefore decomposed preferentially, provided it be present in sufficient quantity, otherwise, fluorine will be liberated; too high a current density also leads to the decomposition of sodium fluoride. The current efficiency of the process is high, 75–80 per cent., and according to some experiments by F. Haber² in which 5·5 volts were used and 7520 amps., the energy efficiency worked out at about 27 per cent. The yield in his experiments per 24 hours was 43·1 kgs., and the current efficiency 71 per cent.; the energy consumption per ton of metal is 23,000 K.W.H., hence one H.P. year gives about ·28 ton.

Loss is chiefly due to the formation of “metal fog” caused by the process being worked at a temperature so much higher than the melting point of the metal (see p. 14).

The following papers contain accounts of laboratory experiments on the production of aluminium by electrolysis—

de Kay Thompson, *Electrochem. Ind.*, 1909, **7**, 19.

Neumann and Olsen, *Zeitsch. Elektrochem.*, 1910, **16**, 230.

H. K. Richardson, *Trans. Amer. Electrochem.*, 1911, **19**, 159.

An exhaustive research on the melting points and densities of various mixtures of cryolite, alumina and calcium fluoride is described by P. Pascal, *Revue de Métallurgie*, 1914, **11**, 1069.

¹ *Zeitsch. Elektrochem.*, 1902, **8**, 26, 607.

² *Met. and Chem. Eng.*, 1911, **9**, 137.

COPPER EXTRACTION

Since 1885 several attempts have been made to win copper by electrolysis of solutions of the ore, or by making coarse metal anodes ($\text{Cu}_2\text{S}, \text{Fe}_2\text{S}_3$) and suspending these in a suitable bath of electrolyte. No method is at present working with any great success, but much capital has been expended on trial plants, and several patents have been taken out. The process is a commercial possibility, and it is probable that when the mechanical difficulties have been surmounted, the electrolytic winning of this metal will become an established industrial process.

When the somewhat lengthy and complex Welsh process for the production of copper is compared with the direct electro-deposition of the metal from its ore, the latter process is obviously possessed of an attractive simplicity, and many efforts have been made to obtain, in one step, a crude copper cathode of 97 or 98 per cent. purity which could then be refined.

The chief difficulties have always been the breakdown of diaphragms and the deposit of sulphur which collects on the anodes, thereby increasing resistance to a prohibitive extent.

In Russia, copper has been produced in certain districts for some time, from non-pyritic ores of the carbonate or oxide class. At Miedzianka, in Russian Poland, and at Karkaralinsk in Siberia, the process of Laszcynski and Stager¹ is used, in which the carbonate or oxide ores are extracted with 5 per cent. sulphuric acid, and this solution electrolysed in a vat with lead anodes which are encased in flannel envelopes to prevent the oxidation of the iron in the electrolyte.

The first process to be seriously attempted on a commercial scale was that of Eugenio Marchese² (1885) which aimed at the separation of copper from sulphide matte anodes in a bath of sulphuric acid containing sulphate of copper and ferrous sulphate; the matte had a composition corresponding to that of "coarse metal," namely, $\text{Cu}_2\text{S}, \text{Fe}_2\text{S}_3$.

¹ D.R.P., 144282 (1902).

² *Zeitsch. Elektrochem.*, 1894, 1, 50.

Ferrous sulphate was converted to ferric sulphate, by anodic oxidation, and this attacked the anode: $\text{Cu}_2\text{S} + 2\text{Fe}_2(\text{SO}_4)_3 = 2\text{CuSO}_4 + 4\text{FeSO}_4 + \text{S}$, the anode was also dissolved simultaneously by anodic oxidation. The mattes used varied considerably in composition; one had the following composition: Cu 17.2, Pb 23.7, Fe 29.2, S 21.01, SO_3 .70, SiO_2 .87, Ag .06.

Trials on a laboratory scale, at Genoa, gave metal of 99.95 per cent. purity; further trials were conducted at Stolberg and, on a small scale, metal of 99.92 per cent. purity was obtained, but a larger plant, to give 500 kgs. per day, failed to come up to expectations. Anode sulphur caused the resistance to rise very rapidly above the allowable maximum, and the anodes dissolved irregularly and crumbled away. A few years later attempts were made by the Mansfeld Copper Company¹ to develop the Marchese process by using "white metal" anodes (Cu_2S); the same difficulties arose with the anodes but apparently were not insurmountable because the process was reported to be running successfully after a twelve months' trial. The chief object in this particular instance was to avoid loss of silver during the Bessemerising of the matte, by stopping the "blow" before the copper content had risen above 76 per cent., as it is found that maximum loss of silver, during the Bessemer treatment, occurs when the copper has reached 79-80 per cent. The "coarse metal" was therefore "blown" in the converter till the copper content was 72-76 per cent. and then cast into anodes. The voltage was kept down to one volt per bath, even with a fairly thick coating of anode sulphur.

In the Process of Siemens and Halske,² the ore is roasted, and then extracted in wood troughs fitted with stirrers, when the ferric sulphate, formed during roasting, dissolves the cuprous sulphide; $\text{Cu}_2\text{S} + 2\text{Fe}_2(\text{SO}_4)_3 = 2\text{CuSO}_4 + 4\text{FeSO}_4 + \text{S}$. The solution is then electrolysed in a two-compartment cell with carbon anodes. After the copper has been

¹ *Métallurgie*, 1908, 5, 27.

² *Zeitsch. Elektrochem.*, 1894, 1, 50; *Eng. and Mining Journ.*, 1892, 53, 327.

deposited in the cathode compartment, the liquor is transferred to the anode compartment where the ferrous solution is oxidised to the ferric state and can then be used to extract more matte. The voltage required for each cell is about .7 volt.

The Hoepfner Process¹ was introduced, about 1890, with the object of extracting unroasted ore with a solution of cupric chloride, on the basis of the reaction: $\text{Cu}_2\text{S} + 2\text{CuCl}_2 = 2\text{Cu}_2\text{Cl}_2 + \text{S}$.

The cuprous chloride formed is kept in solution by means of brine or calcium chloride, and this is electrolysed at a pressure of .8 volt. After depositing most of the copper originally extracted from the ore, the liquor is passed to the anode compartment, where it is oxidised to the cupric state before passing to the extraction vat which contains the powdered ore. The diaphragms frequently caused a breakdown, and in a modified form of the process, which has been used with some success on the Continent, the diaphragm has been abolished. The cell used is shown in section (Fig. 21). It contains an inlet pipe A, for cuprous chloride

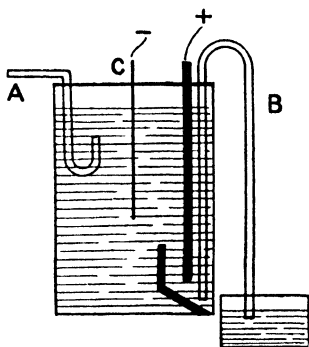

FIG. 21.

solution which deposits part of its copper as it passes the cathode C, on its way to the carbon anode where the cuprous solution becomes converted to cupric chloride, and, since the latter solution has a greater density than the former, it falls to the bottom of the bath beneath the anode and is syphoned off by the pipe B. Diaphragms are therefore avoided by taking advantage of the fact that the solution of cupric chloride has a greater density than that of the cuprous chloride.²

It has been proposed to apply the process of Siemens and Halske to the water pumped from mines containing sulphide

¹ *Chem. Zeit.*, 1894, 18, 1906.

² *Eng. and Mining Journ.*, 1892, 58, 471; *Electrochem. Ind.*, 1903, 1, 540.

ores. Such liquors contain CuSO_4 , H_2SO_4 , FeSO_4 , $\text{Fe}_2(\text{SO}_4)_3$, and, after depositing their copper, could be subjected to anodic oxidation and used for extracting copper ores.¹

ZINC

This metal is produced in very large quantity by electrolysis, especially in America.

Two methods have been in use for some considerable time, namely, the electrolysis of solutions of the chloride or sulphate, and the electrolysis of the fused chloride. The older distillation process is by no means efficient, there is considerable loss of heat and of metal, and for this reason the electro-thermal smelting process received considerable attention prior to 1914. At that time it was regarded with much more favour than the electrolytic processes, but recently, the position has undergone reversal, and now, while electrolytic processes are turning out thousands of tons of metal per week, the electric smelting method has receded into the background.

Aqueous solutions of sulphate are generally used, and these are obtained by leaching roasted zinc ores with dilute sulphuric acid. The conditions necessary for the successful electro-deposition of this metal from aqueous solutions have long been known, and are as follows—

First, moderately strong solutions must be used (40 to 60 gms. of zinc per litre), because, in dilute solutions, hydrogen is evolved at the cathode and the deposited zinc is spongy.

Second, free acid must be present (·01 to ·1 N.) and good circulation of the electrolyte is necessary.

Third, low temperature is essential since too high a temperature produces a spongy deposit.

Fourth, metals less electro-positive than zinc, must be absent, especially copper and arsenic. The last-named element causes spongy deposit, and it has been shown that as little as ·004 per cent. of arsenic causes spongy deposit

¹ *Trans. Amer. Electrochem.*, 1902, 1, 131. See also Electrolytic recovery of Copper from CuSO_4 Leach Liquors, with Carbon Anodes, L. Addicks, *Met. and Chem. Eng.*, 1915, 13, 748.

and evolution of hydrogen in a 10 per cent. zinc sulphate solution.

The Anaconda Copper Company¹ turn out about one hundred tons of electrolytic zinc per day, the metal being deposited from sulphuric acid solution upon aluminium cathodes. This process has probably been carried out in Germany for many years by Messrs. Siemens and Halske, in the production of pure electrolytic zinc having a purity of 99.98–99.99 per cent. At first, anodes of PbO₂ were used, but these were found to disintegrate, owing to the high current density used, and they were replaced by anodes of manganese peroxide which have proved much more durable.

The Laszcynski process,² used in Russian Poland, is of a similar nature. Lead-lined vats are employed, and each vat takes 1500 amps. at a pressure of 4 volts, the current density being about 1 amp. per dm².

Messrs. Brunner Mond and Co., at Winnington, Cheshire, have used, for some time, a modification of the Hoepfner process originally used at Furfurth, in Germany, in 1895–97. In the original process,³ a poor quality blende was roasted with 20 per cent. of salt, at 600° C., and the roasted mass was lixiviated with water giving a solution containing 10–11 per cent. of zinc together with sulphate and chloride of sodium. The sodium chloride was crystallised out by cooling to –5° C.; iron, manganese and nickel were precipitated by bleaching powder solution, whilst lead, copper and thallium were removed by addition of zinc dust. The final solution contained about 9 per cent. of zinc and 20 per cent. of sodium chloride. Carbon anodes were used and diaphragms of muslin.

The process at Winnington utilises the waste chloride of calcium resulting from the ammonia-soda works. Oxide of zinc is treated with carbon dioxide in a calcium chloride solution and the following exchange is brought about—

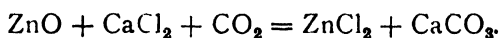

¹ *Met. and Chem. Eng.*, 1916, **14**, 264; 1917, **16**, 9; 1916, **14**, 30, 120.

² *Zeitsch. Elektrochem.*, 1909, **15**, 456.

³ *Eng. and Mining Journ.*, 1903, **75**, 750.

This chloride solution is then electrolysed with a current density of about 1 amp. per dm². and the metal is deposited on rotating cathode drums which press against one another to ensure a firm deposit. One ton of zinc requires about 3500 K.W.H., so that one H.P. year gives about 1.75 tons of metal.

Electrolysis of the Fused Chloride.—This process has been experimentally tested on the small and large scale. Two difficulties have been encountered, namely, the wear and tear on the cell at high temperatures by external heating, and the greater obstacle of dehydrating zinc chloride.

Lorenz has investigated the production of pure ZnCl₂ very completely.¹

The conductivity of the fused chloride at different temperatures has been given as: 400° C. .026; 450° C. .057; 500° C. .104; values which are low for a fused salt. According to Lorenz, the decomposition voltage, at 500–600° C., is 1.49 volts.

Steinhardt and Vogel dehydrated the chloride by evaporation *in vacuo*. Much experimental work was carried out, in London and at Widnes, in conjunction with the United Alkali Company, with a view to perfecting electrolysis in externally heated cells, but the method seems to have been abandoned in favour of heating internally,² and the last traces of moisture are generally removed by electrolysis. The current efficiency of the process was found to be 91.5 per cent. and the energy efficiency was 33 per cent., at temperatures between 450° and 500° C.

In the process of Swinburne³ and Ashcroft, worked in Norway, the blende is mixed with fused zinc chloride in a kind of blast furnace, and chlorine is then driven through the molten mass to expel sulphur and convert the blende into chloride. The fused chloride is then run off and treated with zinc in order to precipitate lead, silver and gold, or the silver may be extracted by agitation with molten lead, and the

¹ *Zeitsch. anorg. Chem.*, 1899, 323; 1900, 284; 1904, 461.

² *Trans. Faraday Soc.*, 1906, 2, 56.

³ Eng. Pat., 10829, 10829A, (1897).

fused salt is then ready for electrolysis. The process was at one time worked by the Castner-Kellner Company as a means of utilising chlorine, the ZnCl_2 produced being sold as such, no attempt being made to obtain metallic zinc from it.

Grünauer¹ found that "metal fog" formation was diminished by the presence of alkali chloride in the electrolyte. At 600° he obtained the following values for current efficiency—

ZnCl_2	73·9–75·9
„ + KCl	92·1–94·7
„ + NaCl	83·9–89·9
„ + 1·2NaCl	89·6–91·2

A molten zinc cathode can be used in a fireclay bath with graphite anodes and the current used, per unit, is about 3000 amps. at 4 volts. About 10 per cent. of the energy is used up at first in electrolysing out the last traces of water contained in the molten chloride.²

If alkali chloride be used in the fused mass, the resistance is lowered and less fuming takes place. The energy efficiency is about 36 per cent.

A process for extracting zinc from blende has been proposed by S. S. Sadtler,³ wherein the blende is digested with caustic soda and hypochlorite; the resulting alkaline solution of the metal is then electrolysed.

The refining of zinc by electrolysis is not an economic proposition except in the case of zinc which has been used in Parkes's process for desilverising lead. The alloy contains, on an average, 11–12 per cent. silver, 80 per cent. zinc, 6–7 per cent. copper, also small amounts of As, Pb, Sb, and Bi, but the electrolytic process has not been able to displace the older process of distillation.

LEAD

The only process which has been working successfully for any length of time is that of Pedro G. Salom, for obtaining

¹ *Zeitsch. anorg. Chem.*, 1901, **27**, 177.

² *Zeitsch. anorg. Chem.*, 1896, **12**, 272; *Electrochem. Ind.*, 1905, **3**, 63.

³ *Trans. Amer. Electrochem.*, 1902, **1**, 141.

metallic lead from galena.¹ The process has been worked by the Electrical Lead Reduction Company at Niagara for some years. Powdered galena is packed on antimonial-lead trays (Fig. 22), each tray is insulated from those next it by rubber rings, and is filled two-thirds full of dilute sulphuric acid, so

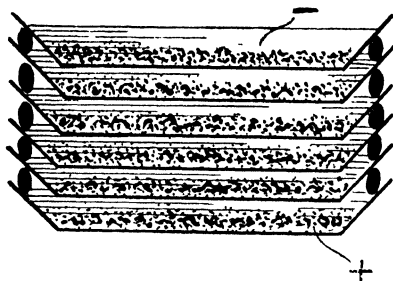
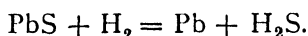

FIG. 22.

that the powdered ore is covered by it; the bottom of each tray is in contact with the acid beneath it. Generally, forty to fifty trays are arranged in series, and the top and bottom ones connected to the source of current, so that the intermediate trays act as bipolar electrodes which

are negative on the top, or galena side, and positive on the bottom. Electrolysis takes place and the hydrogen liberated from each tray reacts with the galena forming hydrogen sulphide and metallic lead—



The spongy lead produced is usually roasted to oxide (litharge), and its average purity is 97 per cent. About 2.5 volts are used per cell, and one ampere per pound of metal produced.

Lead is now being separated in the United States by roasting galena with salt, after which, the solution obtained by leaching with brine is electrolysed.²

NICKEL

The Hoepfner process, similar in principle to the Hoepfner process for copper winning, was almost the first process to be used. Roasted nickel ore was extracted with calcium chloride

¹ *Electrochem. Ind.*, 1902, 1, 18; *Trans. Amer. Electrochem.*, 1902, 1, 87; 1903, 4, 101.

² *Met. and Chem. Eng.*, 1916, 14, 30.

solution containing cupric chloride, and the chief constituents of the ore dissolved according to the following reactions—

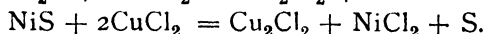
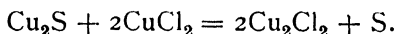

This process did not prove a success and it was replaced by that of Savelsburg and Wannschaff,¹ in which the matte containing about 65 per cent. of nickel and some iron, but almost free from copper, is ground with calcium chloride solution and treated with chlorine; nickel and iron dissolve, sulphur is liberated and partly oxidised to sulphuric acid. After filtering from Fe_2O_3 , SiO_2 and CaSO_4 , the solution, which contains the chlorides of iron and nickel, is maintained at 60–70° C. and air is blown in while freshly powdered ore is added, from time to time, to precipitate the iron—

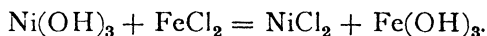

After decantation, the liquor is electrolysed, using nickel cathodes and graphite anodes, with a current density of 1–1·2 amps. per dm^2 . and a pressure of 4–4·5 volts. The cathode nickel has a purity of 99·9 per cent. nickel and cobalt, and contains small quantities of iron, copper and silica.

The Browne² process is used by the Canadian Copper Company, Brooklyn. The copper–nickel–iron matte, containing about equal amounts of nickel and copper, is desulphurised and one half of the product is cast into anodes whilst the other half is granulated and treated with chlorine in the presence of brine; an electrolyte results, containing the chlorides of nickel, copper and iron. The composition of the anodes averages 54 per cent. copper, 43 per cent. nickel, and 3 per cent. iron and sulphur. Electrolysis is conducted in cement tanks with thin copper cathodes; most of the copper is deposited, the nickel of the anodes dissolves and the ratio of nickel to copper in the liquor becomes about 80:1. The remaining copper is thrown out by sodium sulphide, the iron is oxidised and removed as $\text{Fe}(\text{OH})_3$, and after concentration nearly all the

¹ *Zeitsch. Elektrochem.*, 1904, **10**, 821.

² *Zeitsch. Elektrochem.*, 1903, **9**, 392.

nickel chloride crystallises out in a pure state. This is then used to make up a bath, and electrolysed with nickel strip cathodes. The cathode metal averages, nickel 99·85, copper 0·14, iron 0·85 per cent.

Nickel is produced by the Orford Copper Company, New Jersey,¹ using anodes of nickel matte in a bath of nickel chloride.

Some of the difficulties encountered in the electrolytic winning of nickel are described in *Métallurgie*, 1904, 1, 77, also *Electrochem. Ind.*, 1903, 1, 208.

SODIUM

This metal has only been prepared in large quantities, at a reasonable price, since the electrolytic process was introduced, in 1890, by H. Y. Castner.

The Castner process depends upon the electrolysis of fused caustic soda at a temperature near its melting point

which varies with the quality of the caustic. Pure caustic soda melts at 327° C., but the commercial product may have a melting point as low as 300° C.² The melting point of sodium chloride is high (800° C.), unfortunately, a fact which renders it difficult to construct a durable cell for the electrolysis of molten salt, but one

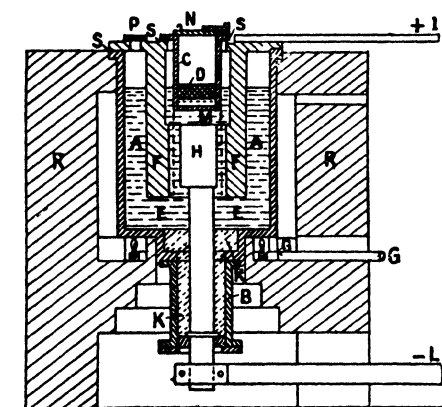

FIG. 23.

or two processes have been patented, and used commercially.

Castner's process is worked by the Castner Alkali Company at Niagara, and by the Castner-Kellner Company at Wallsend. Molten caustic is kept at a temperature of 315–320° C., in an iron pot set in brickwork R (Fig. 23),

¹ *Electrochem. and Met. Ind.*, 1906, 4, 26.

² *Zeitsch. Elektrochem.*, 1909, 15, 539.

the heat being supplied by the ring of burners G. The anode F is of nickel, and surrounds the cathode which is an iron rod H, fixed by solid caustic K, in the base of the pot. A metal gauze cylinder M, between the two electrodes, guides the liberated sodium D to a cylindrical iron receiver C, beneath the cover N, where it collects in an atmosphere of hydrogen. A nickel anode is preferable to one of iron, since the former metal is less attacked by any chloride present in the molten soda.

The temperature must be carefully controlled for successful working, even a few degrees rise in temperature above 320° leads to a very marked fall in the amount of sodium collected.

Small explosions occur at intervals owing to intermixture of hydrogen and oxygen which cannot be completely avoided, but as the cells are never very large (18 in. diameter and 2 ft. deep at Niagara) such explosions are not dangerous.

Each unit at Niagara¹ takes about 250 lb. of molten caustic and uses 1200 amps. at 5 volts; the current efficiency is about 45 per cent., and current density at the cathode is about 2000 amps. per ft². English units are generally smaller.

The reactions which take place during electrolysis are as follows—²

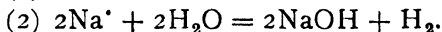
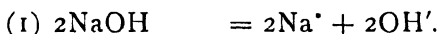

Primarily, the anhydrous hydroxide is electrolysed according to equation (1) but any water present in the caustic will attack the liberated metal according to equation (2). Fresh commercial caustic gives a little hydrogen, at first, by the electrolysis of water present, but after a short time, only sodium is discharged at the cathode.

At the anode the discharged hydroxyl leads to water formation and evolution of oxygen thus—

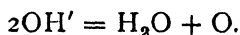

¹ *Electrochem. Ind.*, 1902, 1, 14.

² *Zeitsch. Elektrochem.*, 1902, 8, 717.

If the temperature is too high, sodium diffuses to the anode and reacts with the water formed there, so that under such conditions both hydrogen and oxygen are liberated at the anode, and explosions result. Further losses at the anode are due to the following reactions, all oxidation effects due to elevation of temperature—

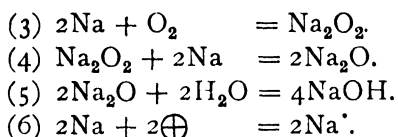

Equations (2) to (6) all represent losses in the Castner process, but under good working conditions the only considerable loss is due to equation (2).

Current efficiency may be as high as 50 per cent., and this could be improved by preventing the access of water to the cathode and retarding or stopping the diffusion of sodium to the anode. A diaphragm suitable for stopping sodium diffusion, made of alumina or sodium aluminate,¹ has been patented which is unattacked by fused caustic soda.

Besides the small explosions due to the action of diffused sodium upon the water formed at the anode, explosions are also due to cathodic hydrogen reacting with the air which leaks into the cell from above, and others are produced by the electrolytic gases evolved from the gauze screen surrounding the cathode, which acts as a bipolar electrode. The temperature is kept down as much as possible in order to suppress diffusion and to prevent the formation of convection currents.

There is a rapid fall in the current efficiency above 330°C., not entirely due to the increased solubility of the metal in fused soda. Potassium can be obtained in better yield by electrolysing molten caustic potash, and one reason for the improved yield is that the metal is not so soluble in the electrolyte as sodium is in fused sodium hydroxide.

¹ Eng. Pat., 14739 (1902).

The following measurements of V. Hevesy show the solubilities in the two cases at different temperatures.¹

Temperature.	Solubility of Na in fused NaOH.	Temperature.	Solubility of K in fused KOH.
480°	25 per cent.	480°	7·8-8·9 per cent.
600°	10·1 "	600°	4-3 "
670°	9·5 "	650°	2-2·7 "
760°	7·9 "	700°	·5-1·3 "
800°	6·9 "		

Between 320° and 340° C., a 27 per cent. yield of sodium is obtained as compared with a 55 per cent. yield of potassium, and this loss in the case of sodium is partly due to its greater diffusivity. The diffusive power of potassium is low and almost constant at 300-550° C., whereas the diffusivity of sodium rises at 330° and even more rapidly at 340°.

The calculated decomposition voltage of sodium hydroxide is 2·2 volts, so that, assuming a current efficiency of 45 per cent., the energy efficiency will be approximately $\frac{45 \times 2\cdot2}{4\cdot5} = 22$ per cent.

From this may be calculated the electrical energy used in the production of one metric ton of the metal—

$$\frac{4\cdot5 \times 100 \times 96,500 \times 1000^2}{45 \times 3600 \times 1000 \times 23} = 11,700 \text{ K.W.H.}$$

Therefore, one H.P. year would give ·56 ton.

*The Darling Process.*²—In this process, fused sodium nitrate is electrolysed, and nitric acid is a by-product; the method is used at the works of Harrison Bros. & Co., Philadelphia, U.S.A., and is regarded very favourably in America.

A two-compartment cell is used to prevent the liberated sodium from reducing the molten nitrate to nitrite. Fused nitrate is in the anode compartment, and the cathode space is filled with fused caustic soda. The (NO₃) ions, discharged

¹ *Zeitsch. Elektrochem.*, 1909, **15**, 531.

² *Electrical World*, 1902, **39**, 136. Eng. Pat., 23755 (1899).

at the anode, decompose into NO_2 , and oxygen which passed into water form nitric acid thus—

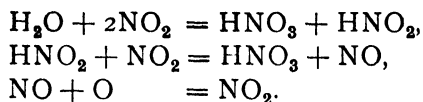

The construction of the cell is shown in Fig. 24. The inner cathode cell 17 is of perforated sheet iron ; it is placed

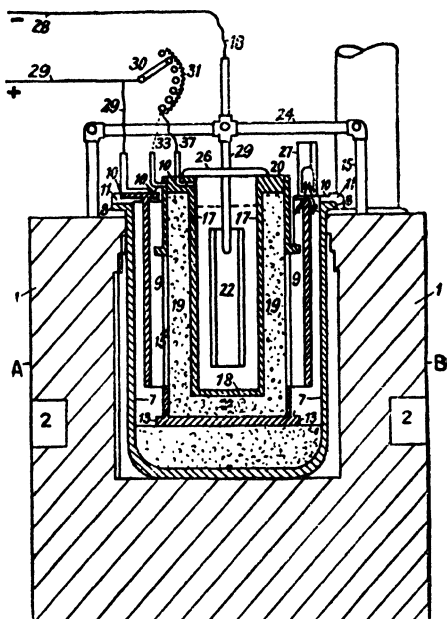

FIG. 24.

within a perforated iron cell 13, and the space between these is filled with Portland cement and magnesia 19, which acts as a diaphragm. This central structure is placed within an iron vessel 7, which is the anode and contains the fused nitrate. The bottom of the anode vessel is covered, to a depth of 6 in., with cement, and the innermost cathode vessel holds an iron tube cathode 22. Each cell takes 400 amps. at 15 volts and a plant of twelve cells decomposes 800 lb. of nitrate per day. Five per cent. of the current is shunted

through the diaphragm by the switch 31, connected to the iron cylinder 17, as this arrangement is found to prolong the life of the cell.

*Becker's Process.*¹—In this process a mixture of molten caustic soda and sodium carbonate is electrolysed at about 550°C. The cell is similar in design to that of Castner, but no wire gauze curtain is used round the cathode, and a truncated cone collector is placed over the cathode, and

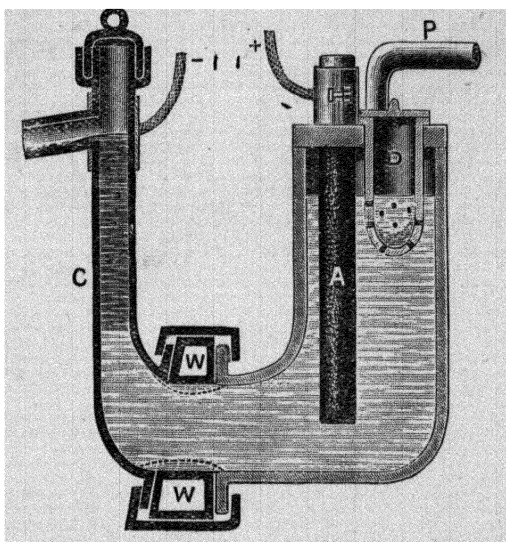

FIG. 24a.

connected electrically with it, this prevents, to some extent, the re-solution of the sodium.

Leblanc and Carrier² have investigated the process and conclude that it is only a modification of the Castner process and not an improvement.

*Contact Electrode Process (Rathenau and Suter)*³—The process is used by the Griesheim Elektron Co. at Bitterfeld. A large iron anode is placed in the middle of a shallow bath of caustic soda and is surrounded, at a suitable distance,

¹ Eng Pat, 11678 (1899)

² *Zeitsch Elektrochem*, 1904, 10, 568

³ D R P, 96672 (1896).

by a ring of metal cathodes which make contact with the electrolyte at the surface only. The current density used is about 1000 amps. per dm².

This process is also intended to be used for the production of the alkaline earth metals, by electrolysis of the fused chlorides.

*Borcher's Cell for Sodium.*¹—This cell is designed for electrolysing fused sodium chloride. It consists of a large U-tube, the two limbs of which are joined by water-cooled connections W (Fig. 24a). The smaller limb C is of iron, and forms the cathode in which the liberated sodium floats on the surface of the fused salt and overflows continuously from the outlet pipe. The larger limb is of earthenware and contains a carbon anode A at which chlorine is discharged; the gas leaves the anode compartment by the pipe P. Solid salt is added at intervals to the chamber which communicates with the anode compartment and keeps it charged with molten salt.

*Ashcroft Process.*²—Invented by E. A. Ashcroft, the process is one for obtaining sodium by the electrolysis of fused salt, using a molten lead cathode. In one of his papers, Ashcroft draws attention to the following facts which should render his process of considerable value. The chief use of metallic sodium is for the manufacture of peroxide and cyanide. During 1906, the United States produced 1200 tons of the metal and equal quantities were accounted for by the factories of England and Germany. This total of 3600 tons was disposed of as follows: for cyanide, 1500 tons; for peroxide 1500 tons; sold as metal, 500 tons. The price of the metal has fallen during recent years from 2s. 6d. per lb. to 1s.

The patents of H. Y. Castner expired, in England, in 1905 and apparently there would be less incentive to try new processes, but Ashcroft calculates that his process, by using fused salt, would almost halve the cost of production

¹ *Elektrochem. Zeitsch.*, 1903, 9, 207.

² *Trans. Amer. Electrochem.*, 1906, 9, 123, 362, 355; *Electrochem. Ind.*, 1906, 4, 477; *Met. and Chem. Eng.*, 1911 9 253.

by savings on material and labour. The patent rights of the Ashcroft Process are said to have been secured by the United Alkali Company, Liverpool.

The salt is maintained in a fused state at about 780°C . in the decomposition vessel A (Fig. 25), which is of iron, lined with magnesia bricks.

The fused lead-sodium alloy forms the cathode, by induction, since the anode is inserted in the electrolyte in A.

At the bottom of the anode cell A, is a layer of molten lead which forms the cathode, and the resulting sodium alloy is transferred to the decomposing vessel B, through the connecting pipe.

In B, the alloy becomes the anode, in a vessel containing fused caustic soda, and through the bottom of which passes

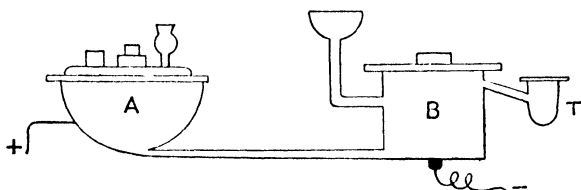

FIG. 25.

an insulated nickel cathode. The temperature of the fused salt in A is about 770°C ., and in B the temperature is 330°C .

Air is excluded from B, and the sodium which rises to the top overflows into T. No hydrogen is evolved at the cathode, so that the current efficiency is doubled as compared with a process where hydrogen is evolved, and the continuous supply of sodium metal without any explosion is facilitated.

The anode current density is about 2000 amps. per ft^2 , and the lead-sodium alloy is circulated by the action of a magnetic coil placed in A. The receiving vessel T is terminated inside the cathode cell by an inverted funnel which is placed vertically over the nickel cathode so that it receives the liberated sodium.

Another process using fused salt is that of Seward and V. Kugelgen.¹

¹ Eng. Pat., 11175 (1910).

LITERATURE

The Processes for manufacturing Metallic Sodium, J. W. Richards, *Trans. Amer. Electrochem.*, 1906, 355.

The Electrolytic Production of Sodium, C. F. Carrier, Junr., *Electrochem. Ind.*, 1906, 4, 442, 475.

MAGNESIUM

The metal was first prepared by Bunsen by the electrolysis of fused chloride. At the present time it is being manufactured by the electrolysis of fused carnallite ($KCl, MgCl_2$) probably in a similar manner to calcium, but it is difficult to obtain details of the procedure.

The melting point of magnesium is $633^\circ C$. and the chloride melts at $708^\circ C$. Anhydrous carnallite of course melts below this, and the working temperature seems to be about $650^\circ C$. At this temperature, as Oettel has shown, the current efficiency is highest, but he recommends a temperature of $700-750^\circ$ to prevent the metal from solidifying. This temperature is also recommended by Borchers.¹

Since sodium displaces magnesium from its fused salts the decomposition voltage of $NaCl$ will be greater than that of $MgCl_2$. At 700° it is 3.2 volts, so that magnesium chloride should be decomposed below 3.2 volts. Borchers found that 5-8 volts were needed, and Oettel used 4-8 volts, so that on an average about 6 volts must be supplied. The current efficiency obtained by Oettel was 75 per cent., and the energy efficiency could therefore be $\frac{75 \times 3.2}{6} = 40$ per cent.

One kg. of metal requires about 17.7 K.W.H., and the addition of some calcium fluoride to the bath makes the magnesium globules coalesce better.

If the voltage be too high, potassium is discharged at the cathode. The Aluminium and Magnesium Gesellschaft, Hemelingen,² use a bath of carnallite containing enough sodium chloride to give an equimolecular mixture of the three chlorides. During electrolysis, fresh magnesium chloride

¹ *Zeitsch. Elektrochem.*, 1895, 1, 361, 394.

² *Zeitsch. Elektrochem.*, 1901, 7, 408.

is added and the bath is kept basic by the addition of alkali; the addition of calcium fluoride is found also to have a beneficial effect.

Hohler states that the optimum temperature is 750–800° C., when a current efficiency of 70 per cent. can be obtained, working with a cathode I.D. of 27–30 amps. per dm².

According to Lorenz,¹ the contact electrode method is used for producing magnesium.

Magnesium has been produced in very large quantities since 1914, and doubtless some modification of the early carnallite process is in use. Of two recent patents,² one is based on the electrolysis of MgCl₂ with CaCl₂ and CaF₂, the other upon the electrolysis of MgO in molten magnesium fluoride.

CALCIUM

Electrolysis of fused calcium chloride is the basis of all modern electrolytic methods for producing calcium. Pure calcium chloride melts at 780° C. and the metal itself at 800° C. By the addition of impurities the fusion point of the chloride may be lowered to 750° C. The finely divided metal burns in air at 800° C., and the molten metal shows a strong tendency to form "metallic fog," hence the range of temperature for working is small; generally 780–800° C. is adopted.

Borchers and Stockem³ obtained small quantities of the metal by electrolysis, in 1902. Similar success was attained by Ruff and Plato,⁴ in the same year, by using a bath made up with 100 parts of calcium chloride and 16.5 parts of calcium fluoride, melting at 660° C. They worked at 760° C. and the I.D. was 3–5 amps. per mm². at the cathode.

The calculated decomposition voltage for CaCl₂ is 3.24 volts, but the actual voltage needed is much higher, about 30 volts.

At the present time a contact electrode process⁵ is in use,

¹ *Zeitsch. Elektrochem.*, 1901, **7**, 252.

² U.S. Pats., 900961, 800489 (1908).

³ *Zeitsch. Elektrochem.*, 1902, **8**, 757.

⁴ U.S. Pats., 806006 (1902). *Ber.*, 1902, **35**, 3612.

⁵ *Zeitsch. Elektrochem.*, 1904, **10**, 508. Eng. Pat., 20655 (1903). U.S. Pats., 864928 (1907); 880760 (1908).

by which commercial calcium is produced. The main parts of one cell are shown in Fig. 26 (cell of Seward and von Kügelgen), from which it will be seen that the stick of metal attached to the iron tongs can be drawn out of the electrolyte gradually, so that it always makes contact with the fused salt. Current density used is about 100 amps. per cm^2 , and temperature is kept at $780\text{--}800^\circ\text{C}$. The cell A is of cast iron, the cathode of iron B is fixed in the bottom, and a carbon lining C concentric with the cathode, forms the anode. Insulating material separates the electrode from the tank, and a cold water-jacket keeps a protective layer of solid electrolyte on the bottom of the cell. The water-cooled ring *b* serves to collect the globules of metal together and to form a cover of solid metal, the nucleus of the cylinder which is to be formed.

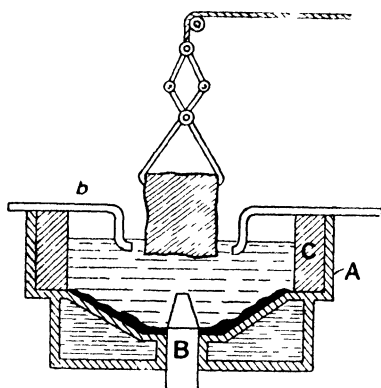

FIG. 26.

is formed, without much trouble, after starting it on an iron cathode cylinder.

Small scale investigations which indicated by their results the best conditions for an industrial process were as follows—

Wohler¹ in 1905 used an externally heated iron vessel with an iron rod cathode, the electrolyte was 100 parts CaCl_2 and 17 parts CaF_2 , melting at 660°C . The working temperature was $665\text{--}680^\circ\text{C}$., and I.D. varied from 50 to 250 amps. per dm^2 . It was found advisable to continually raise the cathode in order to prevent the formation of "metal fog." The voltage used was about 38 volts.

¹ *Zeitsch. Elektrochem.*, 1905, 11, 612.

Goodwin¹ used a bath of fused CaCl_2 at a temperature just above 800°C . He also found that regular raising of the cathode was necessary.

Tucker and Whitney found the current efficiency about 60 per cent.

Frery and Tronson² used anhydrous CaCl_2 , without the addition of fluoride, and with a voltage of 18–31 volts obtained a current efficiency of 80 per cent. Energy efficiency was therefore $\frac{80 \times 3.24}{25} = 10$ per cent., and hence 1 kg. of metal would require

$$\frac{1000 \times 2 \times 96,500 \times 100 \times 25}{40 \times 80 \times 3600 \times 1000} = 42 \text{ K.W.H.}$$

It has been shown that by employing too low a I.D. or too low a temperature spongy metal is produced; on the other hand, too high a temperature brings about re-resolution of the metal.

LITHIUM

Like sodium, this metal is prepared by electrolysis. It has been obtained on a small scale by electrolyzing a fused mixture of lithium and potassium chlorides.³

The metal can also be deposited by using pyridine solutions of the chloride.⁴

Patten and Mott⁵ have patented a process for electrolyzing lithium chloride dissolved in various organic solvents.

Ruff and Johannsen⁶ recommend fused lithium bromide with 10–15 per cent. of chloride, using carbon anodes and iron cathodes. From such a mixture they obtained an 80 per cent. yield, with 10 volts and 100 amps.

ANTIMONY

The process of Siemens and Halske depends on the electrolysis of alkali thioantimonate solution. A two-com-

¹ *Journ. Amer. Chem. Soc.*, 1905, **27**, 1403; 1906, **28**, 85.

² *Trans. Amer. Electrochem.*, 1910, **18**, 117–125; *Journ. Ind. and Eng. Chem.*, 1910, **2**, 466.

³ *Compt. rend.*, 1893, **117**, 732.

⁴ *Journ. Phys. Chem.*, 1899, **3**, 3602.

⁵ *Journ. Phys. Chem.*, 1904, **8**, 153.

⁶ *Zeitsch. Elektrochem.*, 1906, **12**, 186.

partment cell is used, with an iron plate cathode immersed in the thioantimonate solution; the liquid in the anode compartment is sodium chloride.

In Borcher's process, stibnite is digested with aqueous sodium sulphide until the density is 12° Baumé, and the solution is then electrolysed in iron tanks which form the cathodes. Lead anodes are used and a voltage of 2-2.5 volts per cell.

The slimes obtained from lead refining by the fluosilicate method, contain 3-4 per cent. of antimony, and this could probably be extracted as thioantimonate and then deposited by electrolysis.

A. G. Betts¹ has proposed the use of acid solutions containing iron salts, for example, SbCl_3 and FeCl_2 , or antimony fluoride with ferrous sulphate. During electrolysis the ferrous salt is oxidised at the anode to ferric salt, and this can be used to extract more crude antimony or antimony ore.

BISMUTH

Crude bismuth contains about 94 per cent. of the metal with lead 2.2 and silver 3.1; the remainder is composed of copper, antimony and gold. It was proposed by Mohn² (1907) to use this crude metal as anode material in a bath of bismuth chloride acidified with hydrochloric acid, but the process is not satisfactory since it is impossible to prevent deposition of the antimony, copper and silver on the cathode together with bismuth.

A method proposed by Foerster and Schwabe³ gives better results, and a good deposit of pure bismuth has been obtained. A solution of bismuth fluosilicate is used, and from this electrolyte, bismuth, antimony and lead can be separated satisfactorily since the potentials needed for their deposition are sufficiently far apart.

¹ *Trans. Amer. Electrochem.*, 1905, **8**, 187.

² *Electrochem. Ind.*, 1907, **5**, 314.

³ *Zeitsch. Elektrochem.*, 1910, **16**, 279.

CHAPTER IV

ELECTROLYTIC PRODUCTION OF HYDROGEN AND OXYGEN

THE production of these gases by electrolysis has been an industrial operation since about 1895, and there are now several different plants on the market for carrying out the process. They are found chiefly in accumulator works, where the oxy-hydrogen flame is used for lead welding, and in works where a high temperature is needed for melting refractory metals such as platinum.

The development of electrolytic hydrogen and oxygen plant has therefore been largely dependent upon the extended use of the oxy-hydrogen flame. To produce either of these gases, for storing and transport, by electrolysis involves competition with well-established and cheap processes such as the liquefaction of air process for oxygen and the numerous processes at present available for the cheap production of hydrogen gas.

Cheap power would enable the electrolytic process to compete, under favourable conditions, but such conditions are not possible at present, in countries where water power is not available.

Before considering the various processes in use, the fundamental data connected with the electrolysis of water will be reviewed.

The decomposition voltage may be calculated from the heat of formation of water which is 68,400 calories, therefore the electrical energy necessary to decompose one gm.-molecule of water (H_2O) will be $\frac{68,400}{239} = 285,714$ volt-coulombs or joules, since 1 joule = 239 calorie.

Since two equivalents of hydrogen will be liberated, which require $2 \times 96,500$ coulombs, the decomposition voltage will be $\frac{285,714}{2 \times 96,500} = 1.48$ volts.

In practice, the calculated voltage cannot be realised and the pressure required for large-scale work varies about 1.9–4 volts.

Since water itself is almost a non-conductor, it is necessary to add acid or alkali in order that electrolysis may take place; the solutions used therefore, are dilute sulphuric acid 10–20 per cent., or dilute soda or potash 10–25 per cent.

The experimentally determined minimum voltage necessary for the decomposition of these aqueous solutions between platinum electrodes approximate very closely to 1.67 volts.

Since one gram of hydrogen is liberated by the passage of 96,500 coulombs, therefore, one amp.-hour (3600 coulombs) will give 0.0374 gm. of hydrogen, that is, 0.0148 cub. ft. at N.T.P.¹ The average current used in an industrial unit is 400 amps., and this will give approximately $400 \times 0.0148 = 5.93$ cub. ft. of hydrogen per hour, and simultaneously 2.96 cub. ft. of oxygen. This amount of gas will be given by $400 \times 1.67 = 668$ watt-hours or 668 K.W.H., hence 1 K.W.H. will give 8.8 cub. ft. of hydrogen at a voltage of 1.67 volts. In practice 4.5 to 8.25 cub. ft. are obtained per K.W.H.

The following calculation will show the energy consumed per year in an ordinary installation for producing about 15,170 cub. ft. of hydrogen per day—

The annual production, working 24 hours per day and 300 days per year, will be $15,170 \times 300 = 4,551,000$ cub. ft.

Each cell requires per hour 400 amps. at 2 volts, that is 8 K.W.H., and if there be one hundred cells in the installation, the energy used up per year will be $100 \times 8 \times 24 \times 300 = 576,000$ K.W.H. To this must be added about 25 per cent.

¹ N.T.P. stands for normal temperature and pressure, namely, the temperature of 0° C., and the pressure of a column of mercury 760 mm. high, at latitude 45°, and at sea level, the temperature of the mercury being 0° C.

for loss through the motor generator, making a total of 720,000 K.W.H. per year.

If the gases are to be compressed, then 300 lb. per sq. in. for hydrogen will require about 1.6 K.W.H. per hour, that is, $1.6 \times 24 \times 300 = 11,500$ K.W.H. per year.

The oxygen is generally compressed to 1800 lb. per sq. in., and this will need 4.8 K.W.H. per hour, that is, $4.8 \times 24 \times 300 = 34,500$ K.W.H. per year.

Total energy consumption will be $720,000 + 11,500 + 34,500 = 766,000$ K.W.H. per year, in the production of 4,551,000 cub. ft. of hydrogen and 2,275,000 cub. ft. of oxygen.

A brief description of the earlier forms of apparatus will now be given, leading up to the modern forms of plant for producing the gases by electrolysis.

In 1885 D'Arsonval, of the Royal College of France, invented apparatus for supplying oxygen by electrolysis 30 per cent. potash solution. A perforated iron cylinder, which was enclosed in a woollen bag, served as anode, whilst a corresponding iron cylinder served as cathode. The hydrogen was allowed to escape, and the apparatus furnished 100 to 150 litres of oxygen per day.

In 1888 Latchinoff of Petrograd, devised the first apparatus for preparing and collecting both hydrogen and oxygen.¹ The electrolyte was 10 per cent. caustic soda, and iron electrodes were used, while in another form 10-15 per cent. sulphuric acid was the electrolyte in which carbon cathodes and lead anodes were immersed; asbestos cloth diaphragms were employed.

On a larger scale he used an iron tank in which were a number of sheet-iron bipolar electrodes, separated from each other by parchment sheets. Latchinoff was the first to use bipolar electrodes for the electrolysis of water, and the first to arrange for the compression of the evolved gases.

In 1890, Colonel Renard of Paris, Commander of a balloon corps, produced hydrogen in a cylindrical iron vessel which acted as cathode, and in which was suspended a

¹ *Elektrochem. Zeitsch.*, 1894, 1, 108. . D.R.P. 51998.

cylindrical iron anode surrounded by an asbestos sack diaphragm.¹

The apparatus gave 250 litres of hydrogen per hour and the electrolyte was caustic soda solution.

In 1893 Bell's apparatus was patented, but it seems not to have passed laboratory size.²

In the year 1899 the first modern plant was introduced by Dr. O. Schmidt,³ and was built up on the filter-press principle. Reference to Fig. 27 will explain the various parts, construction, and mode of working of the Schmidt plant, which is manufactured by the Maschinenfabrik, Oerlikon, Zurich.

The filter-press is made up of bipolar iron electrodes

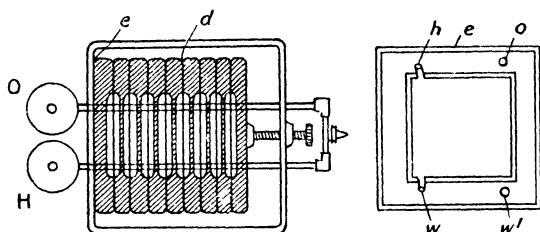

FIG. 27.

separated from each other by diaphragms of asbestos bound with rubber edges.

The iron plates e , which act as bipolar electrodes, have thick edges or rims, so that when near together there is a cavity between two adjacent plates. This cavity contains caustic potash or potassium carbonate solution and is divided into two equal parts by the diaphragms d the rubber edge of which serves to insulate two adjacent plates from each other. Two holes in the thick rims of the iron plate at the top h o , and at the bottom w w' , communicate through the series so that there are two channels above serving to convey away the hydrogen and oxygen, while the two channels below serve to supply the apparatus with electrolyte. For example, w and h

¹ *La Lumière électrique*, 39, 39.

² D.R.P., 78146.

³ D.R.P., 111131. *Zeitsch. Elektrochem.*, 1900, 7, 296.

are connected throughout with the cathode spaces, w' and o with the anode spaces. The two channels for supplying water are connected with a main pipe W , and, at the other end, the two gas channels communicate with the washing chambers H and O ; the stopcock a , is for emptying the apparatus. A complete Schmidt apparatus is shown in Fig. 28.

The electrolyte is a 10 per cent. solution of potassium carbonate. The voltage required is about 2.5 volts and the energy efficiency is approximately 54 per cent.

The purity of the oxygen is 97 per cent. and that of the hydrogen 99 per cent., a purity which is sufficient for most industrial purposes. If the oxygen is required for medical use, it is purified by passing over platinum at 100° C, after which treatment the oxygen content is 99.8 to 99.9 per cent. with .1 to .2 per cent. of CO_2 and nitrogen.

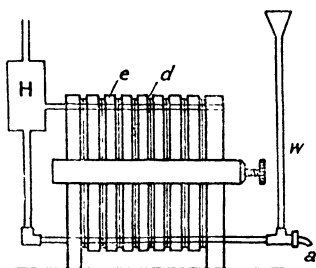

FIG. 28.

The standard types of plant on the market are for working with 65 or 110 volts. Each K.W.H. decomposes 134 c.c. of water, and this loss must be continuously made good so that gases may not collect in the electrolysis chambers.

The cost of a Schmidt outfit for generating 33 cubic metres of oxygen per 24 hours is about £6000. For immediate use, without compression, the gases can be made at a cost of 5*d.* or 6*d.* per cubic metre.

When sulphuric acid is used (20–30 per cent.) with lead electrodes, the conductivity of the electrolyte is higher than that of alkali, but the overvoltages produced at the electrodes are greater than those produced at iron. Although 10–25 per cent. alkali has a lower conductivity than an acid solution, it is possible to use iron electrodes in alkaline solutions, a convenience generally utilised in the construction of modern electrolytic plant. The greatest difficulty met with in

designing plant for the electrolytic production of hydrogen and oxygen, is that of providing a diaphragm which will effectively prevent the mixing of the two gases to form an explosive mixture.

Schoop's Plant.¹—The anodes and cathodes are of lead, and each electrode is encased in a glass or earthenware tube which is perforated around its lower portion and sealed at the top with insulating material. Each electrode is thus completely separated from the rest, and mixture of the gases is rendered impossible.

Dilute sulphuric acid (density 1.235) is the electrolyte

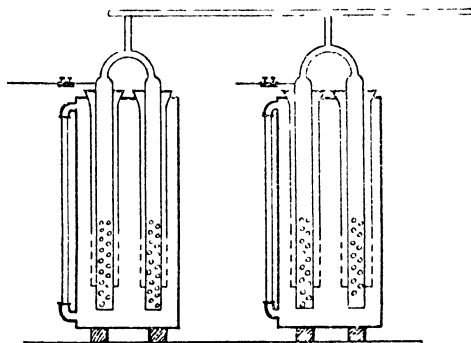

FIG. 29.

used, and the voltage for each unit is about 3.9 volts. The attached diagram will explain the construction of the cell (Fig. 29).

Each unit consists of a cylindrical lead-lined vat which contains two cylindrical lead anodes and two corresponding cathodes. Each lead electrode contains a bundle of lead wires which give a large surface, and the lower part of the electrode is perforated to give free access to the current and the electrolyte. The surrounding glass or earthenware tubes are also perforated, round the lower portion, for the same reason.

Iron electrodes can be used in Schoop's apparatus, with

¹ *Journ. Soc. Chem. Ind.*, 1901, 20 258. D.R.P., 141049. *Electro-Chem. Ind.*, 1902, 1, 297.

alkaline electrolyte, and then the working voltage is about 2.25 volts, as compared with 3.8 volts for sulphuric acid (density 1.235) and lead electrodes.

The following costs are quoted by the makers, for plant with acid electrolyte—

One H.P. hour gives 97.5 litres of hydrogen together with half this amount of oxygen, or stated in another form, one cubic metre of the mixed gases requires 6.2 to 6.8 H.P. hours at a cost of 3*d.* to 3½*d.* With an alkaline electrolyte and iron electrodes the cost is considerably less. The oxygen has a purity of 99 per cent. and hydrogen 97.5 to 98 per cent.

Process of Garuti.—Introduced in 1893, the plant of Garuti and Pompili has had considerable success. The electrolyte is alkaline, and iron electrodes are used.

Anodes and cathodes are connected in parallel, and the diaphragms separating each electrode from its neighbours are iron sheets perforated near the lower edge. The arrangement depends, for successful working, on the fact, first ascertained by Del Proposto,¹ that if the voltage between the electrodes is not above 3 volts, the iron diaphragm between them does not become bipolar, and this principle is applied in the design of the commercial cell. In the early years (prior to 1899) Garuti used lead electrodes and sulphuric acid, but this was ultimately abandoned in favour of iron and alkali.²

The outer box and electrode system are of iron (see Fig. 30). The electrodes *c* are 12 mm. apart, and their lower edges are 12 cms. from the bottom of the tank. Each diaphragm partition has a zone of perforations, 4 cms. wide, running parallel with the lower edge and about 7.5 cms. above it. The anode spaces *a* open at the top, on one side, into a main outlet for oxygen. In a similar manner the cathode spaces *b* open, on the other side, to a common hydrogen outlet.

The hydrogen has a purity of 98.9 per cent. and oxygen

¹ *Bull. de l'Assoc. des Ingen. Électr.*, 1900, 11, 305.

² *L'Industrie électrochimique*, 1899, 11, 113 Eng. Pats., 23663 (1896); 12950 (1900); 2820 (1902); 27249 (1903).

97 per cent. The average consumption of energy is 4.17 K.W.H. per cubic metre of mixed gases, values which corre-

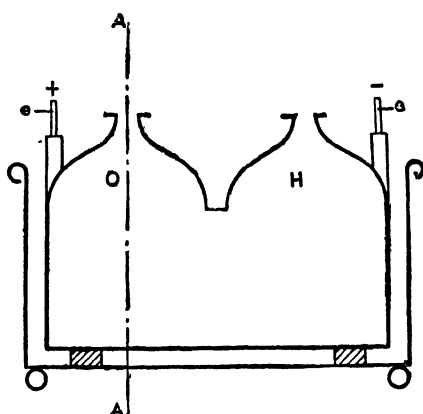

FIG. 30a.

spond with a current output of 96 per cent., and an energy output of 57 per cent.

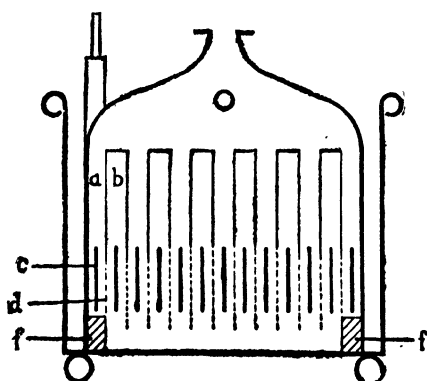

FIG. 30.

Fig. 30a is a side elevation of a Garuti cell and Fig. 30 is a cross section through A A.

The cost of a 100 H.P. Garuti plant, comprising 50 cells each using about 400 amps., and two gasometers for collecting the gases, is about £3000. This is increased to

£4000 if compression plant is required for compressing the gases.

It should be mentioned, that on an average, the electrical energy required for obtaining 2 cub. metres of hydrogen and 1 cub. metre of oxygen, is 13·5 K.W.H.

*Schuckert's Process.*¹—The process was introduced in 1896. Iron tanks are used to contain the electrolyte which is 15 per cent. caustic soda, and the working temperature is 70° C. Sheet-iron bells are used to isolate the electrodes and collect the gas evolved.

Each tank takes about 600 amps., and has the dimensions 26 in. × 18 in. × 14 in., and holds about 50 litres. Each pair of unlike iron electrodes is separated by strips of good insulating material extending from the top, down about three-quarters of the total depth. Between these separating plates, and enclosing the electrodes, are the iron bells which collect the evolved gas and lead it away.

The plant is manufactured by the Elektrizitats A. G. vorm. Schuckert & Co., Nurnberg, and standard types are supplied to take from 100 to 1000 amps.

The following prices are quoted for a plant giving 10 cub. metres of hydrogen per hour—

	£		
Electrolyser	470	<i>Accessories.</i>	
Soda	80		£
Insulating materials . .	20	Two gas-holders	400
Scrubbers, dryers, etc. .	50	Wooden stages for cells	40
Two gas-purifying stoves		Compressors	570
and packing	150	Water still	40
	<u>770</u>		<u>1050</u>

*The International Oxygen Co.,*² *New York.*—The cell consists of an iron tank, acting as cathode, and from the cover is suspended a perforated inner tank which acts as anode, and

¹ D.R.P., 80504. *Electrochem. Ind.*, 1903, 1, 579; *Elektrochem. Zeitsch.*, 1908, 230, 248.

² *Met. and Chem. Eng.*, 1911, 9, 471; 1916, 14, 108.

which is made of low carbon steel to prevent the formation of spongy rust. The anode and cathode are separated by an asbestos sack suspended from the cover. The average current, per cell, is 393 amps. at 2.61 volts, and the working temperature is 30° C. The purity of the oxygen is stated to be 98.3 per cent., and each cell gives over 3 cub. ft. per hour.

A cell somewhat similar to this in design is the Halter cell.¹ An iron tank forms the cathode and in this an inverted box or funnel-shaped iron anode is suspended, and from the edge of this an asbestos sack hangs to prevent mixture of the gases.

Modern Filter-Press Cells.—The filter-press form of cell has been developed considerably. The National Oxy-hydric Co., Chicago,² manufacture a cell of this pattern, in which the electrodes are corrugated to increase the surface; they are made of a special alloy and heavily nickel-plated. The electrolyte is 21 per cent. caustic potash, and asbestos diaphragms are used. The purity of the oxygen is 99.5 per cent. and 4 cub. ft. per K.W.H. are given, with twice that amount of hydrogen.

Other plants of this type are: the Siegfried Barth, Dusseldorf, Oxy-hydrogen generator; the L'Oxyhydrique Française generator,³ the generator of Eycken, Leroy and Moritz.⁴

The following cells of various patterns have been patented, but most of them have not been utilised industrially to any great extent—

The Burdett System, U.S. Pat., 1086804 (1914).

The Tommasini System, U.S. Pat., 1035060 (1912).

Fischer, Leuning & Collins, U.S. Pat., 1004249 (1911).

Siemens & Halske System, *La Machine*, Vol. V, pp. 7, 33.

Siemens Bros. & Obach, Eng. Pat., 11973 (1893).

See also Fr. Pats., 355652 (1905); 198626 (1906).

¹ U.S. Pats., 1172885, 1172887 (1916).

² *Met. and Chem. Eng.*, 1916, 14, 288.

³ Fr. Pat., 459967 (1912).

⁴ Fr. Pat., 397319 (1908).

THE ELECTROLYTIC PRODUCTION OF OZONE

By employing a sufficiently high current density at the anode during the electrolysis of dilute sulphuric acid, a considerable amount of ozone is mixed with the evolved oxygen.

To preserve the anode and increase the yield of ozone it is desirable that a water-cooled anode should be employed, and as low a temperature as possible, below 0° C. With a I.D. of 80 amps. per cm². and a voltage of 7.5 volts, using 15 per cent. sulphuric acid, the evolved oxygen contains 28 gms. of ozone per cub. metre, that is, a yield of 7.1 gms. per K.W.H.¹

With an alkaline solution, a much smaller quantity of ozone is produced.²

A method for large-scale production of ozonised oxygen has been devised by Archibald and Wartenburg,³ in which alternating current is superimposed upon the D.C. used for the electrolysis, and it is found that the amount of ozone is two or three hundred times as great as that obtained with D.C. only. The increased yield is due to the depolarising effect of the A.C. on the anode, and the principle is similar to that used in Wohlwill's improved process for gold refining.⁴ In a trial run, a maximum yield was obtained with an A.C. of 6 amps. and a D.C. of .25 to 1 amp.

¹ *Zeitsch. anorg. Chem.*, 1907, 52, 202.

² *Zeitsch. anorg. Chem.*, 1903, 36 403.

³ *Zeitsch. Elektrochem.*, 1911, 17 812.

⁴ Page 52.

CHAPTER V

ELECTROLYSIS OF ALKALI CHLORIDES

CHLORINE AND CAUSTIC SODA

THE electrolytic manufacture of caustic soda, chlorine, bleaching liquor, hypochlorites, chlorates and perchlorates, has developed from the electrolysis of aqueous solutions of sodium or potassium chloride, by modification of the conditions under which electrolysis takes place.

If a 10 per cent. solution of common salt be electrolysed between platinum or carbon electrodes, chlorine gas is evolved from the anode and caustic soda is formed in the neighbourhood of the cathode. Since the sodium which is liberated at the cathode is attacked by water immediately on its discharge and converted into caustic soda, the only element liberated at the negative electrode is hydrogen. These changes are represented by the following equations—

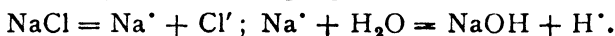

If anode and cathode be not separated by a diaphragm, chlorine will diffuse from the anode and react with the caustic soda to form hypochlorite,

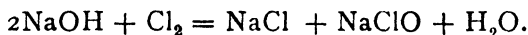

By electrolysing a cold dilute solution of sodium chloride without a diaphragm, formation of hypochlorite results, whilst, if the solution be more concentrated (25 per cent.) and hot (50° C.), chlorate formation is favoured, especially if the solution be slightly acid,

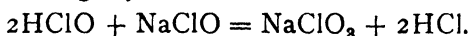

The chlorate will be converted into perchlorate if the current density be high and the temperature low,



The patent of Charles Watt, 13755 (1851), covered the preparation of chlorine, soda, hypochlorite and chlorate by electrolysis of alkali chloride solutions.

The production of chlorine and caustic soda by electrolysis is a rapidly growing industry and is well established in most countries; its development will be discussed first, and then the production of the other valuable, but less widely produced, substances will be considered.

THE ELECTROLYSIS OF BRINE SOLUTIONS

Hydrogen and sodium liberation are both possible at the cathode. The hydrogen ions are more easily discharged, since a cathode potential of only -0.4 volt is required, as compared with a discharge potential of -2.71 volts for sodium in a solution which is normal with respect to sodium ions, therefore, under ordinary conditions hydrogen is liberated and caustic soda is formed.

The electrolytic solution pressure of sodium can be reduced by employing a mercury or lead cathode, when an alloy with the liberated sodium will be formed. The discharge of the sodium is likewise facilitated by using a cathode of metal which has a high hydrogen overvoltage, so that the liberation of sodium at the cathode in aqueous solution becomes possible.

Even by raising the concentration of salt it is possible to obtain sodium discharge at ordinary temperatures if the ionic ratio Na^+/H^+ is thereby made sufficiently high.

The mercury cell is the only technical unit in which, at ordinary temperature, sodium is liberated; in all others hydrogen is liberated and a cathode metal with low hydrogen overvoltage is used. Iron is very suitable, its overvoltage value for current densities between 1 and 10 amps. per dm^2 . being $.3$ to $.55$ volt.

The anodes which are used must withstand the action of chlorine and are therefore made of platinum, graphite or magnetite.

DIAPHRAGM CELLS

*Griesheim Elektron Cell.*¹—This cell has been much used on the Continent. It was one of the earliest industrial chlorine-soda cells, and though it is not so efficient as

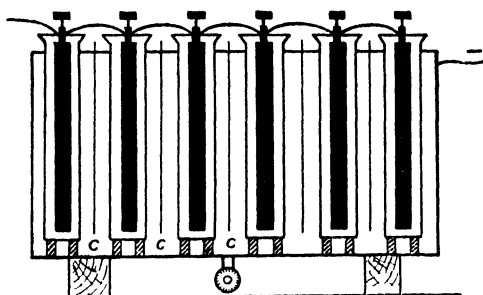

FIG. 31.

some others, it is simple in construction and cheap, gives chlorine of good quality and has very little diaphragm trouble.

Each unit consists of a rectangular iron box (Figs. 31-33)

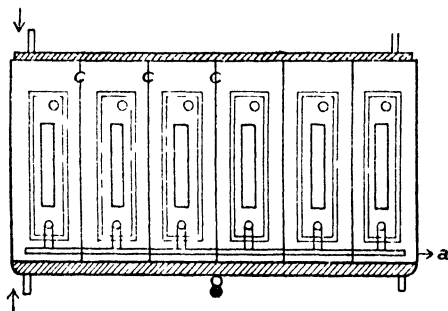

FIG. 32.

which is steam-jacketed, and covered with material which conducts heat badly. It is mounted on insulating blocks and contains six rectangular boxes made of cement, about 1 cm. in thickness. These cement boxes act as diaphragms and contain the anodes A. The outer iron box forms the cathode, and cathode plates are also provided in the form of iron sheets

¹ *Ber.*, 1909, **42**, 2892; *Chem. Zeit.*, 1909, **83**, 299.

C placed between each anode compartment, and reaching almost to the bottom of the cell (Fig. 31). The cell is shown in plan in Fig. 32.

A cross section of the cell (Fig. 33) shows the arrangement of pipes for steam S, salt solution inlet B, outlet for chlorine D, and outlet for caustic soda liquor E. The liquor is generally run through at such a rate that about one-third of the salt used is converted into caustic. Saturated salt solution is used and the working temperature is 80–90° C. If the caustic is allowed to concentrate beyond the above strength, oxygen is given off at the anode by the electrolysis of the water, and part of the current is wasted.

The current density used is 100–200 amps. per square metre (10–20 amps. per ft².) and the pressure for each unit is about 4 volts.

The anodes are of magnetite (Fe_3O_4) made from decopperised burnt pyrites (Fe_2O_3) which is fused in the electric furnace, and a little fresh ferric oxide (Fe_2O_3) added to obtain a homogeneous mass of Fe_3O_4 .

The cylindrical magnetite anodes are said to be much cheaper than graphite (about one-fifth the price) and they last much longer, moreover, they give purer chlorine. Best quality carbon anodes give 5–8 per cent. of CO_2 , and oxygen often amounts to 6–8 per cent.

The cement casing, of which the anode cells are made (D.R.P. 30222) is obtained by mixing cement with salt solution containing hydrochloric acid, and after setting has taken place, the boxes are soaked in water which washes out the more soluble constituents including the salt. In this way a very porous diaphragm results, which offers small resistance to the current and which has proved very durable.

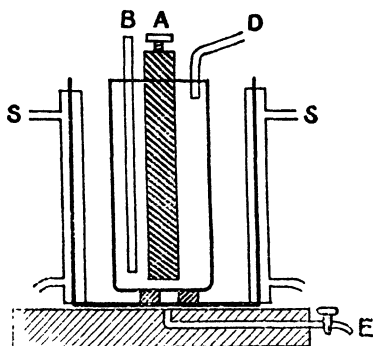

FIG. 33.

The best working conditions for this cell may be summarised as follows—

- (1) Anodes, preferably of magnetite, to obtain pure chlorine and complete absence of carbon dioxide in the anode gas.
- (2) High concentration of brine.
- (3) Temperature should be high in order to reduce the voltage required (80–90° C.).

*Hargreaves-Bird Cell.*¹—A company was formed in 1900 (the Electrolytic Alkali Co.) with works at Middlewich, Cheshire, for the production of carbonate of soda, using this cell. The French rights were purchased by the St. Gobain Co., and the process is used, in America, by the West Virginia Pulp Co.

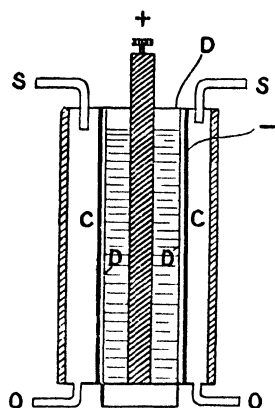

FIG. 34.

Each cell consists of a rectangular iron box, lined with cement, or, in place of iron, sandstone blocks clamped together form the containing vessel. This box is about 10ft. long, 4 ft. to 5 ft. deep and 2 ft. wide, and is divided into three parts, longitudinally, by two asbestos sheet diaphragms D. Six carbon anodes are placed in the central or anode division, and the cathodes C consist of two sheets of copper gauze the same size as the diaphragms and attached to them on the outside (Fig. 34). The copper matting or gauze, which forms the cathodes, is sufficiently strong to form a support to the diaphragms and it is therefore more correct to state that the diaphragms are attached to the cathodes. The two cathode spaces between the copper cathodes and the sides of the cell are empty, except for steam and CO₂ which pass into the top of the cell, when it is working, by the pipes SS.

¹ Eng. Pats., 18039, 18871 (1892); 5197, 18173 (1893). *Electrical World*, 1905, 46, 101; *Journ. Soc. Chem. Ind.* (1895), 14, 1011; *Electrochem. Review*, 1900, 20.

The anode compartment is filled with saturated brine, and during electrolysis this brine percolates through the diaphragm. When it reaches the copper cathode sheet, caustic soda is formed and this is swept to the bottom of the cell by condensed steam and CO_2 ; it therefore leaves the cell as a solution of sodium carbonate or bicarbonate, mixed with sodium chloride, by the pipes OO.

Twelve cells generally run in series, taking 2000 amps., that is, a current density of about 20 amps. per ft^2 , and using a pressure of 4-4.5 volts. About 66 per cent. of the salt is converted into Na_2CO_3 , and approximately 240 lb. of salt are converted into sodium carbonate per 24 hours, giving about 580 lb. of soda crystals, corresponding to 220 lb. of calcined soda ash.

The anodes first used were carbon blocks threaded on a rod of lead-copper alloy, and where the alloy was left exposed, it was packed round with cement. Acheson graphite anodes are now used.

The chlorine produced per 24 hours gives about 360 lb. of bleaching powder, containing 37 per cent. of available chlorine. Reference to the diagram (Fig. 34) shows that the diaphragms must be about 10 ft. long by 4 to 5 ft. deep, and they are about $\frac{1}{8}$ in. thick.

According to Taussig, the Electrolytic Alkali Co. now make bicarbonate of soda by this process.¹

Kellner has devised a cell of the filter-press type for making alkali carbonate and chlorine.²

*Outhenin-Chalandre Cell.*³—This cell, which is used in France and Italy, consists of an iron box which is divided into three sections by vertical partitions. The outer divisions contain the cathode liquor, and the inner one is the anode compartment containing graphite anodes immersed in strong brine.

The diaphragm is made up of a number of cylindrical unglazed porcelain tubes which are cemented into the dividing

¹ *Trans. Faraday Soc.*, 1910, **5**, 258.

² *Journ. Soc. Chem. Ind.*, 1892, **11**, 523

³ Brochet, *La Soude Electrolytique*, p. 103.

walls of the cell in a slanting-position to that. They traverse the anode chamber and are open at both ends, thus connecting the two cathode compartments. Each tube contains an iron cathode and the cathodes are all connected to the negative pole of the current source ; their sloping position facilitates the escape of hydrogen.

A 1400 amps. unit contains 108 cathodes which are arranged in six rows, and there are 19 anodes. The voltage required is about 4 volts per cell and a K.W. day is reported to produce about 6.7 kgs. of caustic soda.

The cell is undoubtedly more complicated than the Griesheim cell and requires more attention.

Townsend Cell.¹—This cell is used in America, and appears to have worked very successfully. It commenced working in 1905 at Niagara with a plant taking 1000 H.P. The first cells were designed to take 2000 amps., but the later types are capable of using 5000 to 6000 H.P.

The construction and working of the cell can be best understood by reference to Figs. 35 and 36, from which it will be seen that a diaphragm is used, and that the structure somewhat resembles that of the Hargreaves-Bird unit. However, the special point of the Townsend cell is the employment of kerosene oil in the cathode compartment to facilitate the rapid removal of caustic soda, as formed, from the cathode, so that diffused chlorine from the anode has little chance of converting it into hypochlorite and chlorate.

The foundation of the cell is a somewhat massive cement foot G (Fig. 35) which is shown in section in Fig. 36, and which takes the form of a wide U. The outer containing-walls of the cell are made up of two strong iron plates CC which are clamped firmly to the cement foot. The bulge on these plates forms the cathode chambers and they carry kerosene inlets DD, and caustic soda outlets EF. The asbestos diaphragm and the cathode of iron gauze are kept in position by the same clamps which hold the outer walls to the central foot.

¹ *Electrochem. and Metall. Ind.*, 1907, 5, 209 ; 1909, 7, 313 ; *Int. Cong. App. Chem.*, 1909, Sect. X. 36.

The arrangement of diaphragm and cathode is shown in the figure, where it will be seen that the diaphragm A forms the wall of the anode chamber, and the cathode B is close against it. B is also in contact with the outer iron wall which is connected to the negative pole of the current source. The anode compartment contains a hollow graphite anode which almost fills the anode space, and through it runs a pipe, by which saturated brine is pumped into the cell.

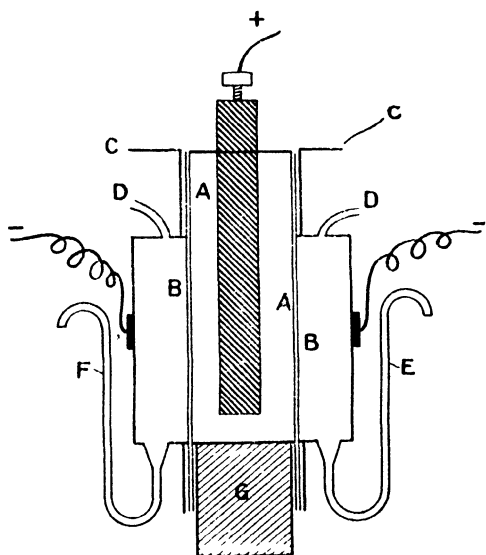

FIG. 35.

When the cell is working, the liquor between anode and cathode is partly converted into caustic soda which streams through the diaphragm to the outer compartment. This exterior chamber being filled with kerosene, the heavier caustic liquor falls to the bottom, where it collects, and ultimately flows out through the outlet pipes EF.

Each cell is about 8 ft. long, 3 ft. high, and 12 in. wide, and is easily taken to pieces for cleaning or repairs. The current density used at first was about 100 amps. per ft², but more recently it has been forced up to 150 amps., with

satisfactory results. The voltage required is about 4 volts per unit; and about 15 to 20 litres of brine pass through each cell per hour. The resulting caustic soda liquor contains about 150 gms. NaOH and 200 gms. NaCl per litre, but it is possible to run the brine through at a rate of 24 litres per hour, and, by increasing the current density, to obtain a caustic liquor holding 200 gms. of NaOH in the litre. The caustic is free from hypochlorite and chlorate, and this is a sign of high efficiency because a fall in efficiency is always attended by formation of NaClO and NaClO₃, and the presence of these substances is objectionable on account of their corrosive

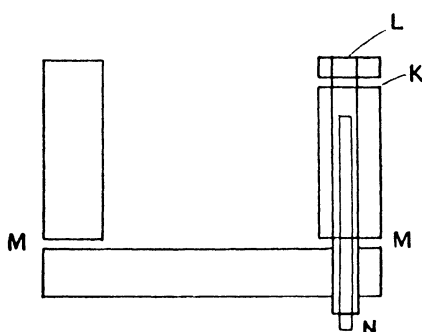

FIG. 36.

action on the anodes, and on the vacuum pans during the subsequent concentration of the liquors.

Usually, the diaphragm is cleaned every 30 days, and composite graphite anodes are used so that only the corroded portions need to be replaced. Aluminium conductors have also been

used instead of copper ones as they are more resistant to the action of chlorine.

The diaphragm used in this cell is a patent of H. L. Baekeland, and consists of asbestos, the pores of which have been filled with ferric oxide and colloidal Fe(OH)₃.

Current efficiency is 96–97 per cent., and the usual voltage is 3·4 to 3·6 volts. The process after a three years' run was pronounced to be quite satisfactory.

By reducing the rate of percolation of the liquor through the diaphragm, it is possible to obtain as much as 250 gms. of NaOH per litre. The level of the anode liquor controls the rate of percolation.

In Fig. 36 is seen the adjustable glass pipe N, which slides up and down in an outer tube L; this glass pipe communi-

cates with the anode liquor, and by raising it, the level of the liquor is raised, whilst if it be lowered the excess of anode liquor runs away through it. In the same figure MM are flushing channels for washing out the bottom of the cell; and K is an outlet for chlorine gas from the anode compartment.

The cathode liquor (about 14 per cent. NaOH) runs out in two continuous streams from the side tubes EF. The loss of oil by evaporation, etc., is small, about eight to ten shillings' worth per day in a large plant.

About 5 tons of caustic were produced daily at Niagara, and 11 tons of bleaching powder; the finished caustic contains about 2 per cent. of Na_2CO_3 and a little NaCl.

The life of the vacuum pans and finishing kettles is said to be very long on account of almost entire absence of chlorate and hypochlorite. The "bottoms" which are left in the finishing kettles are also said to be small, amounting to only 1 ton per 700 tons of finished caustic.

The energy efficiency of this cell is reported to be 45 per cent., a little less than that of the Griesheim cell.

*Finlay Cell.*¹—This cell is the subject of Eng. Pat. 1716 (1906) by Messrs. Archibald and Finlay of Belfast. According to Professor Donnan, it has given good results and produces a caustic soda liquor containing 12 per cent. of NaOH. On the other hand, it has been stated that the strength of caustic soda is only about 8 per cent., and this would detract from the value of the high energy efficiency of the cell which is stated to be about 75 per cent.

The industrial unit is constructed on the filter-press principle, and some idea of its construction can be gained by a study of Figs. 37 and 38. Fig. 37 gives a section through one type of single experimental cell from which it will be seen that a sheet-iron cathode is separated from the graphite anode by two asbestos diaphragms DD; between these is an intermediate space into which the brine solution flows from the cistern B. Outlets are provided in

¹ *Trans. Faraday Soc.*, 1909, 5, 49; Allmand, *Applied Electro-Chemistry*, p. 380.

anode and cathode compartments for the gas and liquor produced in each, EA and HC.

The mixing of anode and cathode liquor is entirely

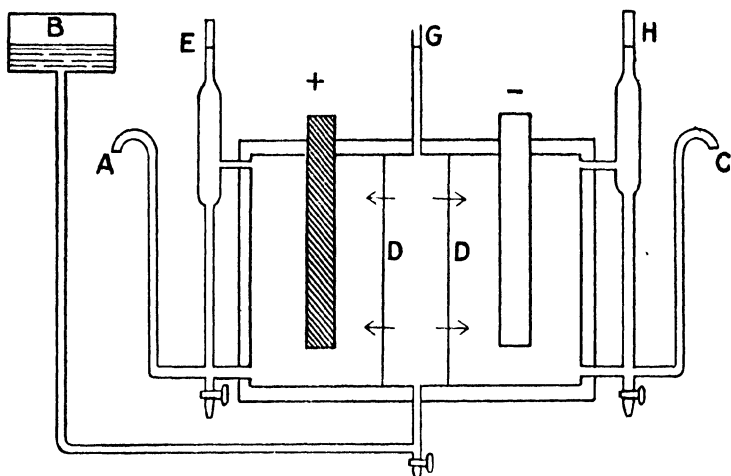

FIG. 37.

avoided by the motion of the brine from the centre feed chamber. This prevents diffusion of chlorine and formation

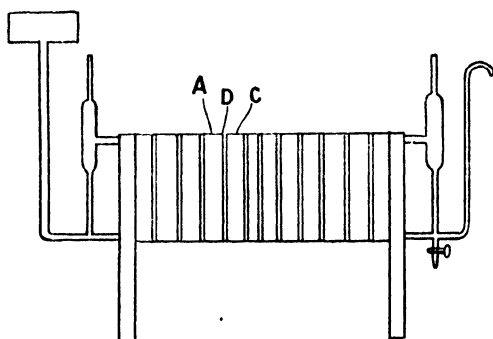

FIG. 38.

of oxy-halogen compounds, and it also prevents the passage of OH' to the anode from the cathode. In the technical unit the separate cells are fixed end to end until a unit of sufficient size has been built up; Fig. 38 shows this

arrangement. Cathode and anode spaces are formed by means of distance frames in which the electrodes are supported. The iron cathode C, for example, is followed by a cathode diaphragm of asbestos D, against this is a waxed cardboard separator $\frac{1}{16}$ in. thick, and this forms the brine space enclosed on the other side by the anode diaphragm; then follows the anode.

In this way a series of anode and cathode chambers are formed, with communicating pipes leading to the main pipes for outlet of liquor and gas. A 2000 amps. unit only occupies 5ft. \times 2.5ft. \times 4ft. high, and very pure chlorine is obtained.

*Macdonald Cell.*¹—This cell is in use at the New York & Pennsylvania Company's Paper Mills, Johnsonburg, Pa., and the plant there gives 16 tons of bleaching powder per day together with $6\frac{1}{2}$ tons of caustic soda.

The cell is also used by the Standard & Colorado City Works for chlorinating gold. It is simple in construction and gives satisfactory and economical results. Each cell is made up of an iron tank which serves as cathode, 5ft. long, 2 ft. high and 2 ft. wide; the tank is divided longitudinally into three sections by two perforated iron plates. The middle portion forms the anode compartment and contains ten graphite anodes; it is separated from the outer cathode compartments by asbestos diaphragm sheets which are fixed on the inside of the perforated iron plates which divide off the anode compartment.

The main object of the installation at Johnsonburg was to provide chlorine for bleaching purposes; the caustic soda was for some time run to waste, but subsequently arrangements were made for collecting and evaporating it down. It contains 3-4 per cent. of salt and 16-18 per cent. NaOH.

*Le Seur Cell.*²—This cell also, has been installed in several American paper mills. It is made of iron and is divided into two compartments by a diaphragm of asbestos E (Fig. 39), which is fixed to the iron gauze cathode C. The anode

¹ *Electrochem. Ind.*, 1903, 1, 387; 1907, 5, 43; *Eng. and Mining Journ.*, 1903, 75, 857.

² U.S. Pat., 723398 (1903).

compartment A is filled with brine, and contains a graphite electrode; this compartment is sealed by a brine seal HH which also serves as the entrance for fresh brine flowing from the pipe B, and chlorine escapes through the pipe D. The liquid level in the anode compartment is slightly higher than in the cathode part to ensure a steady percolation of liquid in the right direction, anode to cathode, and the caustic which is formed flows out through the outlet K. The block G fixes the cathode at its lower end.

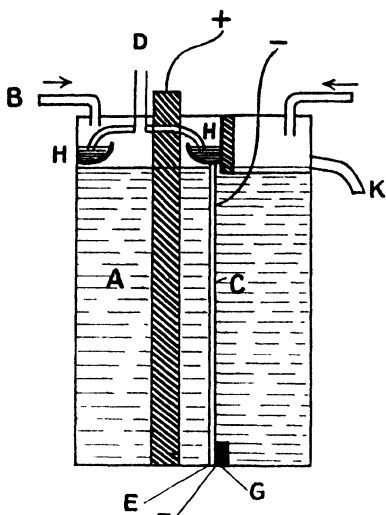

FIG. 39.

Billiter-Siemens Cell.¹—

This is a diaphragm cell with a bell anode chamber, but the mouth of the bell is closed by a diaphragm of asbestos which rests on the negative electrode of nickel netting. Inside the bell, the anode of carbon is suspended, and the whole is immersed in an iron vessel which forms the cathode chamber. The diaphragm is horizontal and it is composed of asbestos cloth on which is laid a powdered mixture of barium sulphate, alumina and asbestos wool

which is made into a coherent mass by the addition of salt. It is stated that the patent rights have been purchased by Siemens & Halske, and the cell is used in several works, one of which is the Niagara Alkali Co.

According to J. B. Kershaw, the cell is one of the most efficient of the well known alkali-chlorine cells; this statement is substantiated by a study of the efficiencies tabulated below.²

¹ Eng. Pat., 7757 (1907). *Journ. Soc. Chem. Ind.*, 1913, **32**, 993; *Trans. Faraday Soc.*, 1913, **9**, 3; *Zeitsch. angew. Chem.*, 1910, **23**, 1072, 1375.

² *Journ. Soc. Chem. Ind.*, 1913, **32**, 993.

Cell.	Current Efficiency.	Energy Efficiency.
Castner-Kellner . . .	91 per cent.	52.3 per cent.
Hargreaves-Bird . . .	80 "	54 "
Aussig "bell" . . .	87.5 "	40.9 "
Griesheim . . .	75 "	48 "
Billiter-Siemens . . .	92 "	68 "
Billiter-Leykam . . .	95 "	59 "
Townsend . . .	94 "	45 "
Finlay . . .	98 "	75 "

MERCURY CELLS

In these cells a mercury cathode is used which forms a liquid amalgam with the discharged sodium; this amalgam is transferred to a separate compartment where it is decomposed by water and the sodium converted into sodium hydroxide.

Discharge of hydrogen from neutral solution requires a cathode potential of -1.4 volt, and, with the current density and temperature usually employed, the hydrogen overvoltage at mercury is 1.25 volts which corresponds to a necessary voltage of -1.65 volts for hydrogen discharge.

By using a dilute amalgam the sodium discharge potential is lowered from about -2.7 volts to approximately -1.5 volts, so that, under these circumstances, sodium will be discharged in preference to hydrogen. The discharge potential for sodium, at the surface of an amalgam saturated with that metal, is -1.8 volts.

The anodes are of platinum or carbon, the working temperature is about 50°C ., and the amount of sodium in the amalgam must not exceed .02 per cent.

Particles of carbon falling on the mercury surface facilitate evolution of hydrogen, and the chlorine gas therefore frequently contains 2-3 per cent. of hydrogen. If platinum anodes are used, the amount of hydrogen is usually less than .5 per cent.

The electrolyte used is generally 30 per cent. salt solution from which sulphate, lime and iron have been removed. Cathode I.D. varies about 5-25 amps. per dm^2 , and at the

anodes it is greater; a high I.D. at the anode favours pure chlorine because electrolysis then takes place at the surface of the carbon where chlorine concentration is constant. A low current density means evolution of oxygen from the interior of the anode, and this is accompanied by a certain amount of CO_2 .

Elevation of temperature leads to hydrolysis of the chlorine and production of carbon dioxide—



The advantages of the mercury cell are—

- (1) Concentrated soda liquor can be obtained (24 per cent. or more).
- (2) A high current efficiency is obtained (95 per cent.) and no oxygen is evolved.
- (3) The purity of the caustic soda is high, 99 per cent. with 1 per cent. chloride and carbonate.

The chief disadvantages are the high cost of mercury, of which about 70 tons are needed for a 6000 H.P. plant, and the higher voltage required (4.3 volts) as against 3.8 volts for a diaphragm cell. On the other hand it is claimed by mercury cell advocates that the voltage required is actually less than for the average diaphragm cell. However, the voltage seems in both cases to be about 4 volts, and for the Townsend diaphragm cell it is 3.4 to 3.6 volts.

The initial cost of the mercury is, perhaps, not excessive when regard is paid to the cost of evaporating the much weaker caustic liquors obtained from diaphragm cells.

The earliest mercury cell was that of H. Y. Castner¹ (1892). This was a comparatively small cell of the rocking type, and its subsequent improvement, in conjunction with Kellner, resulted in the Castner-Kellner Cell. The construction of the Castner mercury cell is shown in Fig. 40. The cell is constructed of slate or earthenware, is rectangular in shape, about 4 ft. \times 4 ft. \times 6 in. deep, and requires about 200 lb. of mercury. Two partitions which divide the cell

¹ Eng. Pats., 16046 (1892); 10584 (1893). *Chem. Trade Journal*, 1894, 15, 211; *Electrochem. Ind.*, 1902, 1, 12.

into three equal compartments, and reach to within $\frac{1}{8}$ in. of the bottom of the cell, fit into grooves, so that a very thin layer of mercury permits communication between the compartments. The two outer anode compartments contain brine, and there are two graphite anodes AA; the chlorine evolved is drawn off by pipes at the top of each anode compartment. Water circulates through the middle compartment C, and this contains an iron grid cathode. A rocking motion is given to the cell by an eccentric wheel W, which, as it turns, causes the cell to rise and fall at that end, so that the mercury circulates backwards and forwards. The sodium which is discharged on the mercury in the anode compart-

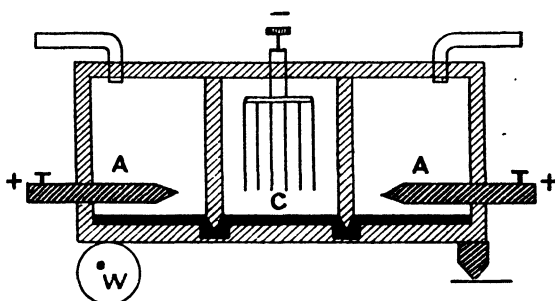

FIG. 40.

ments is transferred, by the rocking movement of the cell, to the cathode compartment where it is attacked by the water circulating through C, and converted into caustic soda, while an equivalent amount of hydrogen is evolved.

The mercury in the cathode compartment, having given up its sodium, ultimately finds its way back to the anode compartment to be recharged with alkali metal. According to one account of the working of the cell,¹ 144 cells are used, each taking 560 amps. at 4 volts, and under these conditions each cell gives $\frac{3}{4}$ gallon of 20 per cent. soda per hour. Forty tons of bleaching powder are made per week from the chlorine evolved. The mercury is cleaned by mechanical means, and by treatment with dilute nitric acid, at intervals. Loss of

¹ *Journ. Soc. Chem. Ind.*, 1913, 32, 995.

mercury during working is small, and amounts to something like 2 per cent. per annum. Care is needed to prevent any considerable formation of hydrogen in the anode compartment at the mercury, otherwise explosions will occur.

The current efficiency of the cell is stated to be 91 per cent. and the energy efficiency 52.3 per cent.

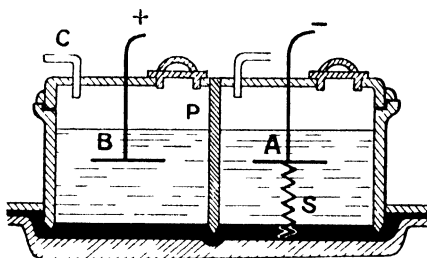

FIG. 41.

The Castner-Kellner cell is shown in Fig. 41 to consist of two compartments separated by a non-porous earthenware partition P ending in a metal cap, and by arranging that the floor has a slight incline, the cell can be made large since no rocking mechanism is needed. The mercury flows out at the

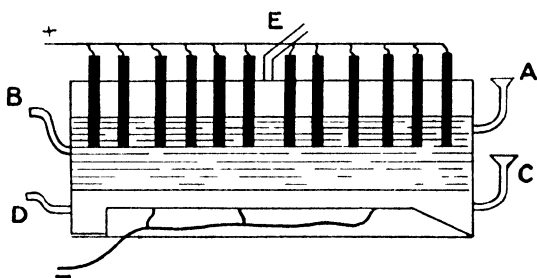

FIG. 42.

lower end and is pumped back to the anode compartment continuously.

Concentrated brine is contained in B, and water in the cathode compartment A. The secondary cathode S diminishes the electro-positive character of the mercury so that it does not oxidise easily and remains clean for a considerable time.

Kellner Air-Pressure Cell.—A short account of this cell is given by Taussig¹ in an article on electrolytic cells. The circulation of the mercury in this cell is brought about by the aid of compressed air.

*Solvay-Kellner Cell.*²—This is a comparatively large stationary cell in which the mercury flows through the cell by gravity (see Fig. 42).

A row of carbon anodes dips into the brine which enters at A; the brine on its passage across the cell is decomposed, and the resulting caustic liquor flows out at B. The mercury enters at C, and leaves by D after giving up its charge of sodium. Chlorine is drawn off by the pipe E. This cell is in use at Jemeppe, in Belgium, and at Weston Point, Cheshire.

*The Whiting Cell.*³—In this cell, provision is made for the periodic removal of the amalgam. After the mercury has acted as cathode for two minutes it is automatically removed to another compartment where the sodium is acted upon by water, and at the same time its place is taken by fresh mercury. The temperature is kept below 40° C., there is little risk of chlorate formation, and the carbon anodes are found to last well.

The chlorine evolved contains 2 per cent. of hydrogen. Voltage used is 4 volts, and the current efficiency is 90–95 per cent. The plant at the Oxford Paper Works, Rumford, M.E., turned out, in 1910, eight tons of caustic soda per day, and the corresponding amount of chlorine was converted into bleach. The caustic liquor has an average strength of 20 per cent.

Whiting has pointed out that cells which promised well when worked on a laboratory scale have often not been successful on an industrial scale. He mentions the instances of the Rhodin cell and the cells devised by Bell Bros., which involved those concerned in great financial loss. He states further, that even when a process is intrinsically sound, there

¹ *Chem. Zeit.*, 1909, **33**, 588; *Trans. Faraday Soc.*, 1909, **5**, 258.

² D.R.P., 104900 (1898). *Trans. Faraday Soc.*, 1910, **5**, 258.

³ *Trans. Amer. Electrochem.*, 1910, **17**, 327.

are often practical difficulties which cannot always be surmounted, and he quotes the example of attempts, in Japan, to work the purchased rights of the Castner Process for caustic soda, which up to 1910 had not proved successful and had occasioned heavy financial loss. The chief difficulty to be overcome in the mercury process is, undoubtedly, the proper transfer of the sodium amalgam from anode to cathode compartment. On the other hand, the process, in the hands of the Castner Alkali Co., at Niagara was a success almost from the start.

Rhodin Cell.¹—The cell is not now in use. It was worked for a short time at Sault Ste. Marie by a company which

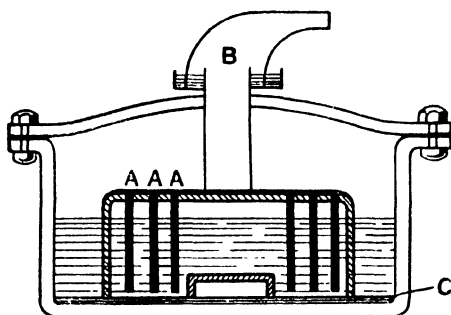

FIG. 43.

purchased the patent rights from Rhodin, but the venture failed as the cell did not come up to expectations when employed on a large scale.

The anodes A of graphite are contained in a hood or bell of earthenware (Fig. 43), which is rotated at a speed of 30 r.p.m. At the bottom of the shallow iron dish (diameter 5 ft.) is a layer of mercury which forms the cathode C.

By the rotation, the sodium amalgam, formed under the bell, is centrifuged outwards, attacked by water when outside the bell, and the sodium converted to caustic. The anode compartment contains brine, and the chlorine leaves by a pipe B in the top of the bell. On losing its sodium, the

¹ D.R.P., 102774 (1896). *Journ. Soc. Chem. Ind.*, 1902, 21, 449; *Zeitsch. Elektrochem.*, 1903, 9, 366.

mercury, being denser than the amalgam, falls to the floor of the annular space and is driven back to the centre where it again takes up more sodium.

The cell was used by the Canadian Electrochemical Co., and was almost the first electro-chemical process to work at Sault Ste. Marie.

*The Edser-Wilderman Cell.*¹—This cell is made of iron lined with patent ebonite which resists the action of both chlorine and caustic soda. It is divided into anode and cathode compartments by a series of circular V-shaped channels, fixed one over the other. This partition or diaphragm

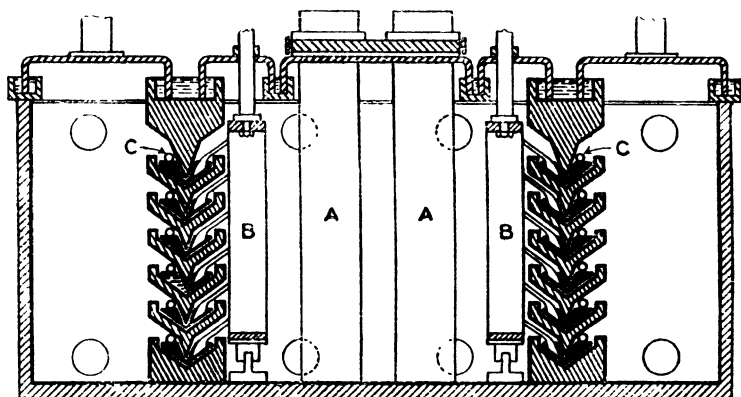

FIG. 44.

is made continuous by partly filling each channel with mercury so that the two compartments only communicate through the mercury seal thus arranged (see Fig. 44). The inner or anode compartment is filled with brine; it contains graphite anodes AA and a stirring arrangement BB by which the mercury in the channels is kept in motion. This motion causes the amalgam which is formed to flow to the cathode side of the channel, *i.e.* the caustic soda compartment, where it becomes converted into caustic. The stirrer consists of ebonite blades with teeth dipping into the channels of

¹ Eng. Pats., 18958 (1898); 22902 (1900); 9803 (1902). *Trans. Faraday Soc.*, 1909, 5, 258; *Trans. Amer. Electrochem.*, 1912, 22, 445.

mercury, and pieces of carbon C in electrical connection with the mercury in the outer compartment facilitate the decomposition of the amalgam.

In the early form of this cell the inventor depended upon the difference of surface tension between sodium amalgam and mercury for the transfer of amalgam in the channels, but the stirrer was found to greatly increase the value of the cell. The strength of caustic soda produced is 20 per cent. and does not often contain more than '2 per cent. of chloride. A high current density can be used, as much as 60 amps. per dm^2 , since the mercury circulation is very efficient, and very little hypochlorite and chlorate are produced.

The Castner and Solvay cells are required to work with a current density of 6–8 amps. per dm^2 . since if higher, solid amalgam is formed, but in the Wilderman cell the circulation of the mercury is so efficient that there is no risk of forming solid amalgam, even with a much greater current density. This means a smaller cell for equivalent output, with consequent saving of floor space.¹ The current efficiency is high, 90–92 per cent. A large installation was in use in 1910, at the works of the Zellstoff-fabrik, Waldhof, Mannheim, for producing 10,000 tons of bleach per year.

THE BELL PROCESS

The use of a bell of earthenware or iron, to enclose the anode, is the chief feature of these cells.

There is no diaphragm, but advantage is taken of the motion of the electrolyte, as a whole, to carry the caustic liquor away from the anode and prevent its contact with chlorine. The bells are usually made of iron and are cemented inside to form the anode compartment; alkali chloride enters the anode compartment and a distributing arrangement ensures the regular distribution of the brine to the anolyte. Sometimes the outside of the bell, which is rectangular, forms the cathode, at other times an iron cathode surrounds the bell.

¹ *Int. Cong. App. Chem.*, 1912, Xa, 185.

A sharp alkali boundary, or a neutral layer, forms just inside the mouth of the bell, and the migration of OH' ions to the anode is counteracted by the steady flow of brine from the bell. Caustic soda solution overflows continually from a pipe in the upper part of the cathode compartment.

Sometimes as many as twenty-five bells are hung in a cement vessel which forms the cathode chamber;¹ each bell contains a graphite anode and each is coated with iron sheet or gauze to act as cathode. All the bells are connected in parallel, and saturated salt solution passes through an opening in the anode and is distributed by passing through a number of small holes as shown in Fig. 45. The heavy caustic sinks

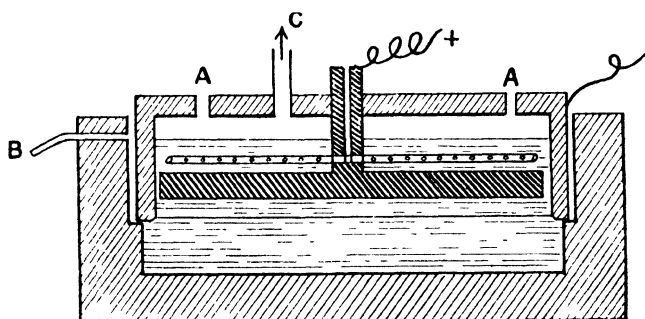

FIG. 45.

to the bottom of the trough and is removed by the overflow pipe B. The openings AA, in the bell, are connected so that the gas pressure remains constant throughout the bells. Chlorine is drawn off through the pipe C.

*Billiter-Leykam Cell.*²—This is a modified form of the Billiter-Siemens diaphragm cell, and it is also an improvement on the ordinary bell cell. From Fig. 46, it will be seen that each cell contains one bell which is an inverted cement box A. The distance between anode and cathode can be altered so that the resistance between them can be controlled and the voltage adjusted.

The bell contains a chlorine outlet B, and an inlet for

¹ D.R.P., 141187 (1900).

² Eng. Pat., 11693 (1910). *Trans. Faraday Soc.*, 1913, 9, 3.

brine D ; the graphite anode is cemented into the bell. The cathode C is of iron, T-shaped, and is encased in asbestos to facilitate the removal of hydrogen. Caustic soda falls to the bottom and flows out through the pipe H. The current density used is 5-7 amps. per dm^2 . and the pressure 3.1 to 3.2 volts ; each K.W.H. gives 45 kg. of caustic (NaOH) and .4 kg. of chlorine.

Since the direction of the liquid flow does not change at the bottom of the bell, the rate of flow is practically constant at all points, and larger units can be employed, with higher temperatures, than in that type of bell cell where the liquid is obliged to turn up, at the edge of the bell, in order to reach

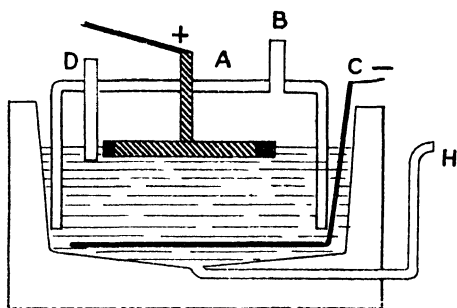

FIG. 46.

the outlet. This cell is considered to be one of the most efficient non-mercury cells for producing caustic soda.¹

*The Acker Process.*²—This is a process for electrolyzing fused salt, with carbon anodes and a molten lead cathode.

The cell is made of cast iron and lined with magnesia brick ; its construction is such that the molten lead, charged with 20-25 per cent. of sodium, can be skimmed away mechanically to a steam-jet chamber where it is decomposed, and the metallic sodium converted into anhydrous caustic soda. After the removal of the sodium, the molten lead is returned to the electrolysis chamber. Fig. 47 shows how the

¹ *Journ. Soc. Chem. Ind.*, 1913, **32**, 995.

² *Trans. Amer. Electrochem.*, 1902, **1**, 165 ; *Zeitsch. Elektrochem.*, 1903, **9**, 364 ; *Electrochem. Ind.*, 1906, **4**, 477.

anodes are arranged so that they dip into a 6-in. layer of fused salt and approach to within one inch of the lead cathode

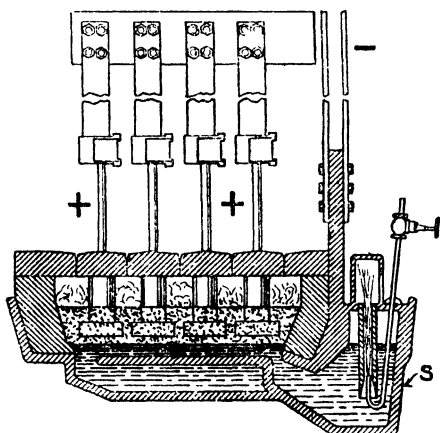

FIG. 47.

upon which the fused salt rests. The lead-sodium alloy flows continuously to the steam-jet chamber S where steam is blown in at a pressure of two or three atmospheres.

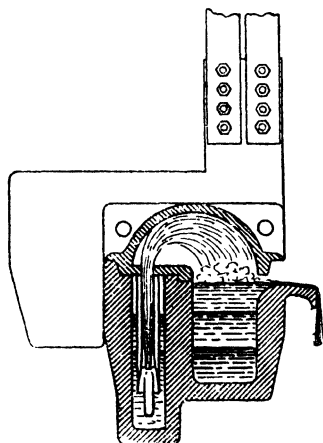

FIG. 48.

Fig. 48 shows a section through the steam chamber which explains how the sodium alloy, carried up at a temperature

of about 500° C., falls over into the caustic vessel and deposits any molten lead. Caustic soda flows by the spout to a receiving vessel. The chlorine gas contains some oxygen and is converted into bleach in a plant adapted for use with dilute chlorine. Anode I.D. is about 300 amps. per dm². and the working temperature about 850° C. Current efficiency is usually 93–94 per cent., and each cell gives approximately 580 lb. of solid caustic per day, containing 98 per cent. NaOH. One ton of caustic requires about 5000 K.W.H., hence one K.W. year gives about 1·4 tons. The cell was used with success, at Niagara, between 1900 and 1907.

The Vautin Cell,¹—Fused salt is used in this process, other chlorides being added to lower the melting point. Carbon anodes are immersed in the fused electrolyte, and the cathode is of molten tin which is withdrawn at intervals when sufficiently rich in sodium, by an outlet pipe at the bottom of the cell.

Caustic soda production by electrolysis of fused chloride, using a molten lead cathode, is the subject of German Patent 189474 (1906).

From the foregoing description of the various alkali-chlorine cells, it is evident that electrolytic production is a widely established industry. Almost every European country has works of this class, and in America many small plants are working in connection with wood pulp mills.

The manufacture of caustic soda, bleaching powder, chlorates and perchlorates is certain of rapid future development, and the production of various chlorinated organic bodies will serve to utilise the chlorine produced. The Leblanc process works will probably find their strongest line of development to be sulphur products. In short, the alkali works of the future will centre around either chlorine or sulphur.

The ammonia-soda process stands alone, but should the chloride waste liquors become utilised, as for example in the

¹ Eng. Pat, 13568 (1893); 9878 (1894). *Journ. Soc. Chem. Ind*, 1894, 18, 448

production of electrolytic zinc, it will become more closely allied to the chlorine alkali industry.

For every ton of caustic soda produced by electrolysis, there is evolved sufficient chlorine to form $2\frac{1}{2}$ tons of bleaching powder. Hitherto, the chlorine has been difficult to dispose of and the electrolytic soda industry will progress more steadily if a good market for this gas is assured.

LITERATURE

The Purification of Electrolytic Chlorine, U.S. Pat., 1166524.

The Electrolytic Soda Industry, M. L. Moynot, *Monit. Scient.*, 1907, **66**, 586.

Electrolytic Production of Caustic Soda, C. P. Townsend, *Electrochem. Ind.*, 1902, **1**, 23.

Electrochemistry at Sault Ste. Marie, J. W. Richards, *Electrochem. Ind.*, 1902, **1**, 86.

Influence of some Impurities in Salt on the Yield of Caustic Soda by the Mercury Process, Walker and Paterson, *Trans. Amer. Electrochem.*, 1903, **3**, 185.

Formation of Metallic Dust at Cathodes during Electrolysis of Alkali Chloride Solutions, F. Haber, *Trans. Amer. Electrochem.*, 1902, **2**, 189.

The Cost of Alkali Chloride Electrolysis, Engelhardt, *Met. and Chem. Eng.*, 1911, **9**, 489.

Present Position and Future Prospects of Electrolytic Alkali, J. B. Kershaw, *Trans. Faraday Soc.*, 1907, **3**, 38.

CHAPTER VI

HYPOCHLORITES. CHLORATES. PERCHLORATES

WHEN an aqueous solution of alkali chloride is electrolysed in a cell without a diaphragm, the chlorine liberated at the anode reacts with the hydroxide which is formed at the cathode, and the following reactions take place according to the amount of chlorine or soda present.

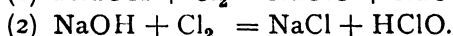
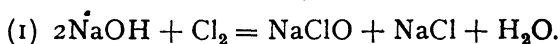

The hypochlorite formed commences to decompose as its concentration increases, and the rate of decomposition rises with the concentration.

Decomposition of the hypochlorite is due partly to the reducing action of cathodic hydrogen, and partly to the action of water on the hypochlorite ion at the anode—

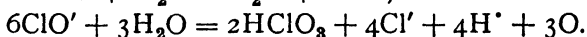
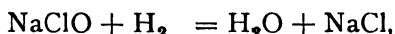

The hypochlorite is further decomposed by the action of hypochlorous acid¹ in the following manner—

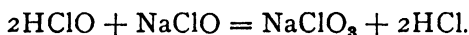

Although a weakly alkaline solution of hypochlorite is stable, and likewise a weakly acid solution of hypochlorous acid, when mixed, they react as shown by the last equation.

Chlorate is also formed by the spontaneous decomposition of the hypochlorite, as well as by its anodic oxidation—

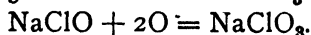
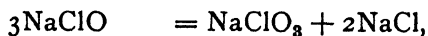

¹ *Journ. pr. Chem.*, 1899, 59, 53; 1901, 63, 141.

Both chlorine and oxygen may be liberated at the anode but the oxygen discharge, at platinum electrodes, is subject to a high overvoltage (about 1 volt), and chlorine is therefore more readily discharged from a dilute solution. The voltage required for the continuous discharge of oxygen from platinum is 1.8 volts, and for the discharge of chlorine it is 1.37 volts, so that, under ordinary conditions, hydrogen is liberated at the cathode, and near to it the electrolyte becomes alkaline, while an equivalent amount of chlorine is discharged at the anode.

Knowledge concerning the reactions which take place during the electrolysis of alkali chloride solutions is largely due to Foerster and his co-workers. The following facts have been ascertained.

The interaction of chlorine with hydroxyl, to produce hypochlorous acid, is fairly complete, $\text{Cl}_2 + \text{OH}' = \text{HClO} + \text{Cl}'$, but in solutions which are more concentrated it is possible to detect free caustic soda and chlorine. Bromine and iodine are much less reactive, and in these two cases a considerable quantity of free halogen can exist in alkaline solution.

Hypochlorous acid forms water with hydroxyl, especially if the acid solution be moderately concentrated: $\text{HClO} + \text{OH}' = \text{H}_2\text{O} + \text{ClO}'$.

Combining the last two equations we get, $\text{Cl}_2 + 2\text{OH}' = \text{H}_2\text{O} + \text{ClO}' + \text{Cl}'$, the ionic expression of the well-known equation $\text{Cl}_2 + 2\text{NaOH} = \text{H}_2\text{O} + \text{NaClO} + \text{NaCl}$, which represents, fairly well, what obtains in practice. The most stable system resulting from the reaction of chlorine upon alkali is $\text{NaCl} + \text{O}$, and not NaClO , owing to the instability of the hypochlorite, $2\text{ClO}' = 2\text{Cl}' + \text{O}_2$, and the oxygen liberated helps to form chlorate thus—



If only one molecule of chlorine reacts with two molecules of NaOH , the rate of chlorate formation is very slow, but the formation of additional hypochlorous acid accelerates chlorate production. In practice this result is secured by allowing slightly more chlorine to be discharged than is required by

the equation, $\text{Cl}_2 + 2\text{NaOH} = \text{H}_2\text{O} + \text{NaCl} + \text{NaClO}$, as a result, hypochlorous acid is formed, and since there is not sufficient alkali to neutralise this, the reaction denoted by equation (1) can proceed.

Chlorate production takes place at the anode where hypochlorous acid accumulates, but its formation is suppressed by maintaining a low temperature. It is possible to prevent the cathode reduction of hypochlorite by adding alkali chromate¹ to the bath; this possibly acts favourably by the formation of a layer of chromium oxide on the cathode, which is affected by the discharged hydrogen before the latter has an opportunity of attacking the hypochlorite. Addition of other compounds has a beneficial result; such are, certain aromatic sulphur compounds and some calcium salts.²

Concentration of hypochlorite is limited by the discharge of hypochlorite ions; it is also attacked by water, as indicated in an earlier equation, a change which is represented by Foerster and Muller³ by the equation—

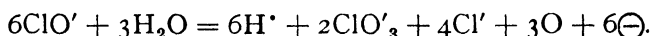

Platinised platinum anodes suppress the discharge of hypochlorite ions and the loss due to chlorate formation; and a high chloride concentration favours Cl' discharge, which hinders ClO' discharge and so favours concentration of hypochlorite.

The chief conditions to be observed in order to obtain a high yield of hypochlorite are—

- (1) Concentrated chloride solution which also has the effect of increasing conductivity.
- (2) Low temperature and high anode current density.
- (3) Presence of alkali chromate in the bath and the use of platinised platinum anodes.
- (4) Magnesium and calcium salts, if present in the salt used, should be removed, because $\text{Mg}(\text{OH})_2$ and $\text{Ca}(\text{OH})_2$ are precipitated during electrolysis, the

¹ *Zeitsch. Elektrochem.*, 1899, **5**, 469; 1901, **7**, 398; 1902, **8**, 909.

² D.R.P., 141372 (1903); 205087 (1908).

³ *Zeitsch. Elektrochem.*, 1902, **8**, 665.

solution consequently becomes acid and chlorate formation is increased.

It is not always profitable to adhere strictly to these conditions; it is advisable to make a dilute hypochlorite solution because the energy efficiency falls off with increase in hypochlorite concentration.

Technical Cells.—Bipolar electrodes are generally used because compact plant can be made and the number of exposed metallic connections is reduced; there is, however, some danger of shunt current losses which are greater with a

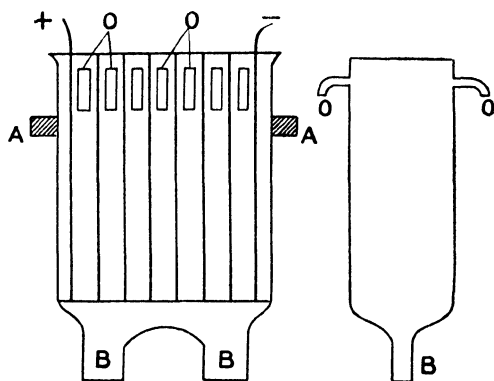

FIG. 49.

high concentration of salt, since the drop in voltage between the electrodes is as high as 4–6 volts.

*Kellner Cell.*¹—The vertical type of this cell is widely used and is supplied with several electrolytic bleaching plants which are on the market, notably, those of Siemens Bros. & Co., Mather & Platt, and Siemens & Halske. The cell consists of a deep rectangular trough of earthenware with supports AA (Fig. 49), divided into a number of vertical chambers by glass plates which are wound round with platinum iridium wire or covered with netting of the same material; these plates form the bipolar electrodes. The end electrodes are provided with platinum coated leads.

¹ D.R.P., 99880 (1894); 104442 (1896).

Brine enters the bottom of the cell at B and overflows at the top through slits or spouts OO into the main supply tank underneath. The liquor in this tank is cooled and returned to the electrolyser, this circulation being continued until the hypochlorite has reached the required concentration. Generally, there are twenty compartments in each unit, taking

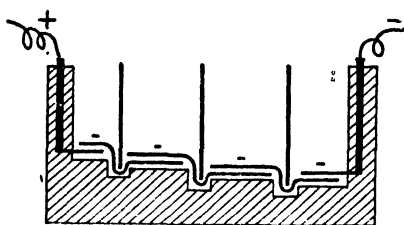

FIG. 50.

a pressure of 110 volts and a current density of 50–100 amps. per dm^2 . The brine used contains 10 per cent. of chloride with .1 to .5 per cent. of sodium chromate.

The first electrolytic bleach cell used on the large scale was that of Hermite which was employed in Scotland and in France about 1888. The pioneers in the electrolytic bleach

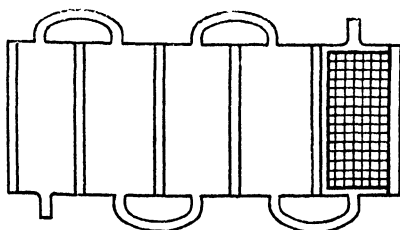

FIG. 51.

process were Hermite in England, Karl Kellner in Vienna, and Stepanoff in Russia, whose process has been working since 1891.

In another form of the Kellner cell, horizontal electrodes are used.¹ Each cell is again divided into a number of compartments by vertical partitions of glass, and these compartments communicate by channels alternately on each side (see

¹ D.R.P., 165486 (1903).

Figs. 50 and 51). The bipolar electrodes are of platinum, each sheet being bent under the partitions so that one half forms the cathode of one compartment, and the other half forms the anode in the next compartment.

The cooled electrolyte circulates through the cell by gravity, its concentration is 10–15 per cent. of sodium chloride with .5 per cent. of alkali chromate. The anodes are very close to the bottom of the cell and the cathodes where gas is evolved are 5 mm. above. There are thirty-six compartments in a 220 volt unit; which takes 60 amps. at a temperature of 21° C.

*The Schuckert Cell.*¹—This cell is used by the Siemens-Schuckert Co., Berlin. Bipolar electrodes of platinum-iridium are used, and each earthenware cell is divided into nine compartments and contains a cooling coil. Two cells are generally connected in series and take a pressure of 110 volts at the terminal electrodes. Efficient circulation is assured by causing the electrolyte to pursue a zigzag course on its way through the cell. Calcium chloride and sodium rosinate are dissolved in the electrolyte.

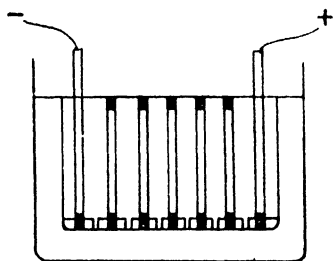

FIG. 52.

*Haas-Oettel Cell.*²—This cell is largely due to the efforts of Professor Oettel of Zurich, whose ideas show considerable novelty and ingenuity. He invented a cell in which platinum electrodes are replaced by carbon or metal, and in which automatic circulation is possible. According to Reuss³ this cell is likely to supplant all the older hypochlorite cells. The cell consists of two earthenware vessels, one within the other, and the brim of the smaller vessel is just below the surface of the brine which fills the larger outer vessel (Fig. 52). The

¹ D.R.P., 141724 (1902). *Electrochem. Ind.*, 1903, 1, 439.

² D.R.P., 101296 (1896); 114739 (1900). *Zeitsch. Elektrochem.*, 1901, 7, 319.

³ *Journ. Soc. Dyers and Colorists*, 1911, 27, 110.

electrodes, of metal wire or carbon, are bipolar, and are insulated at top and bottom by glass insulating caps; these caps prevent the carbon from wearing at the top edges, and, at the bottom of the trough, they prevent the sediment from producing a short circuit.

Openings between the electrodes in the bottom of the small trough allow cold brine to enter the electrode cell, where the increase in temperature and evolution of gas cause the liquor to rise. The bleach liquor therefore rises to the top and flows off, while fresh brine takes its place from below. Earthenware channels are provided on both sides, at the top, for the overflow of bleach liquor.

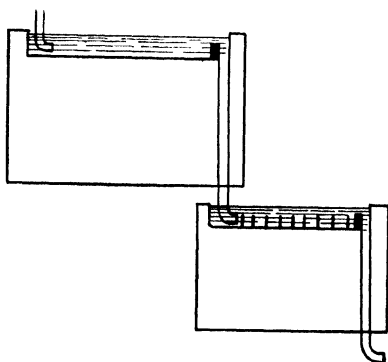

FIG. 53.

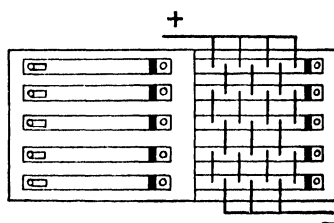

FIG. 54.

Schoop Cell.¹—In this cell, shown in section (Fig. 53) and in plan (Fig. 54), the brine flows through a number of channels from cell to cell in cascade fashion. The electrodes of platinum foil project into the channels, and they are arranged in such a manner as to cause the intermediate sheets to become electrodes by induction (see Fig. 54).

Hermite Process at Poplar.²—Electrolytic bleaching liquors are made by the Poplar Borough Council, for disinfecting purposes, by the Hermite process. The power consumption is about 7.2 K.W.H. per kg. of active chlorine, and for this quantity 13.5 kgs. of salt are necessary. The concentration

¹ D.R.P., 118450, 121525 (1899).

² *Trans. Faraday Soc.*, 1906, 2, 182.

of the salt solution is 5 per cent., and it contains, in addition, 1 per cent. of MgCl_2 ; the working temperature is 30°C .

Most hypochlorite cells take 6–7 K.W.H. per kg. of active chlorine, and this only represents an efficiency of 20–25 per cent. The losses are due mainly to low current efficiency and the high overvoltages at the electrodes.

CHLORATES

The formation of chlorate by electrolysis is dependent upon the reaction $2\text{HClO} + \text{NaClO} = \text{NaClO}_3 + 2\text{HCl}$, which is accelerated by slight acidity and by rise of temperature to 60° or 70°C .

The solution used contains about 25 per cent. of alkali chloride, and the addition of alkali chromate is beneficial.

Foerster and Muller¹ have thoroughly examined the conditions favourable for chlorate formation, and shown the necessity of a slight acidity, such as may be produced by CO_2 , in order to liberate the hypochlorous acid, necessary for the above reaction. They proved the necessity of preventing cathodic reduction either by employing a high cathode I.D. or by adding alkali chromate, and the need for a temperature above 40° to prevent formation of perchlorate.

The earliest technical cell was devised by H. Gall and de Montlaur² and was used in Switzerland for a number of years, even as late as 1900. A diaphragm was employed, the anodes were of platinum-iridium, and the cathodes of platinum or nickel. The solution contained 25 per cent. of chloride, at a temperature of $45\text{--}50^\circ \text{C}$., and the alkali hydrate, from the cathode compartment, circulated through the anode compartment and reacted with the chlorine there evolved to form chlorate. Current density was 50 amps. per dm^2 . and each cell took 4.5 to 5 volts.

Other cells of the diaphragm type were invented by Hurter in 1893, and by Blumenberg³ in 1894.

¹ *Zeitsch. anorg. Chem.*, 1899, **21**, 1, 39.

² Eng. Pat., 4686 (1887).

³ Eng. Pats., 15396 (1893); 9129 (1894).

In 1899, Imhoff¹ patented the addition of alkali chromate to the bath, and this rendered the diaphragm unnecessary.

The process of Gibbs² for chlorate production is used by the National Electrolytic Co. at Niagara.

Each cell consists of a wooden trough lined with lead and divided into four parts. The anodes B are of sheet lead

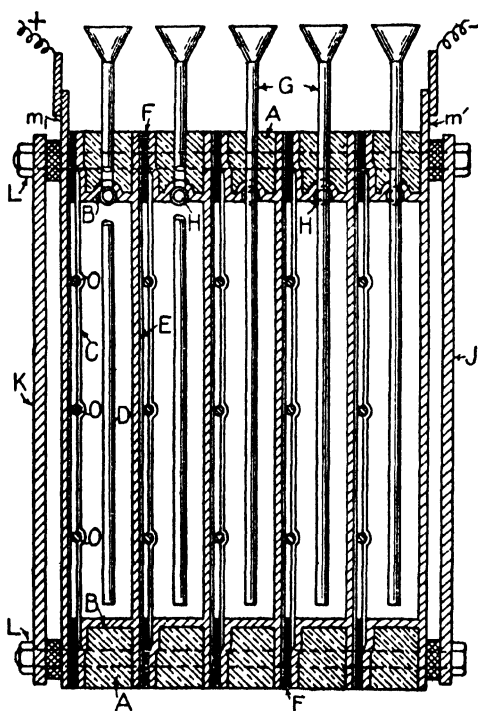

FIG. 55.

covered with platinum foil, and the cathodes C consist of copper wires fixed vertically in the cell by insulating bars O (Fig. 55). There is no diaphragm, the temperature is maintained at 60–70° C., and the brine flows through the cell at a rate of 28 litres per hour; anode I.D. is 500 amps. per ft². This particular plant was capable of producing

¹ U.S. Pat., 627063 (1899).

² *Electrochem. Ind.*, 1902, 1, 11.

4000 lb. of chlorate per day. Alkali chloride is fed in through G, and the chlorate liquor drawn off through H.

In continental factories the process devised by Lederlin and Corbin¹ is widely used, and is the subject of numerous patents. The two sections of Fig. 56 show a cement tank through which the brine (25 per cent.) circulates, at a temperature of 70° C. The platinum bipolar electrodes A are set close together in ebonite frames D, the distance between two electrodes being 1.5 cms. The frames are kept in position by wood supports B C. The chloride enters the tank by the pipe E, and after circulation the chlorate formed leaves at F.

Chlorides of magnesium or calcium are added to the

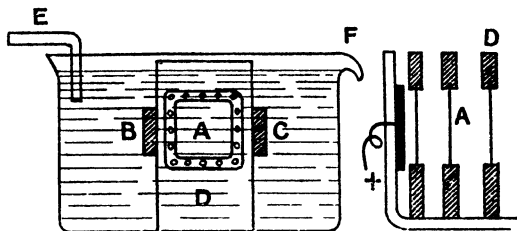

FIG. 56.

bath, as their presence is found to assist chlorate formation, and one gram of potassium chromate is added per litre. The anode I.D. is 10–20 amps. per dm². (90–180 amps. per ft².), and the voltage between adjacent electrodes is 4.5 to 5 volts. If potassium chlorate is being made, the liquors are drawn off when sufficiently strong, and the chlorate allowed to crystallise. In making sodium chlorate, when the concentration has reached 500–600 gms. of NaClO₃, and 100 gms. of sodium chloride per litre, the liquor is evaporated, to remove crystals of chloride, and then, on further cooling or evaporating, the chlorate separates out. Provided the concentration of the chloride is maintained sufficiently high there is no fear of perchlorate formation.

Substances other than chromate are added to the electro-

¹ Fr. Pats., 226257 (1892); 238612 (1894); 110505 (1898); 136678 (1901); 283737 (1904).

lyte by various makers to prevent cathodic reduction, namely, aluminium salts, clay, or silicic acid by the United Alkali Company;¹ alkali fluorides by Siemens and Halske;² and vanadium compounds by the Solvay Works.³ In the process of Threlfall and Wilson,⁴ free chlorine is formed by making the current density greater at the anode than at the cathode.

A process patented by A. G. Betts has been devised for obtaining potassium chlorate by electrolysis of the chloride solution which results from the suitable treatment of felspar. The resulting mixture of sodium and potassium chloride is electrolysed with carbon anodes, and magnesium cathodes are employed to avoid the expense of platinum.⁵

PERCHLORATES

The formation of perchlorate is dependent upon the prior formation of chlorate, and it is usual to employ a bath of chlorate, and to convert this, at a low temperature, into perchlorate by anodic oxidation; $\text{NaClO}_3 + 2\text{OH}' + 2\oplus = \text{NaClO}_4 + \text{H}_2\text{O}$.

During the electrolysis of sodium chloride solution, the chlorate formed will be partly transformed into perchlorate if the concentration of the chloride is low and the current density small. Above a concentration of 10 per cent. there is no formation of perchlorate to speak of, provided the solution is warm or hot, so that, conditions favouring perchlorate formation from chloride are: a dilute solution of the latter (under 10 per cent.), and low temperature accompanied by low current density.

In order to convert chlorate to perchlorate the following conditions have been laid down by Winteler—⁶

- (1) Low temperature at anode (artificial cooling).
- (2) Acid solution at anode.
- (3) Current density 4–12 amps. per dm².
- (4) High concentration of chlorate (60–70 per cent.).

¹ Eng. Pat., 1017 (1899).

³ D.R.P., 174128 (1905).

⁵ U.S. Pat., 918650 (1909).

² D.R.P., 153859 (1903).

⁴ D.R.P., 143347 (1902).

⁶ *Chem. Zeit.*, 1898, **22**, 89

According to Couleru,¹ starting with brine, the electrolysis is carried on until the concentration of the chlorate is about 750 gms. per litre; the chlorate is then allowed to deposit and is afterwards re-dissolved in water and electrolysed with smooth platinum anodes and iron cathodes. Any alkali formed during electrolysis is neutralised, and the temperature is kept at 8–10° C. A temperature above 25° C. is injurious, and it is necessary as a rule to cool the electrodes. Couleru recommends the addition of calcium chloride or sodium chromate for obtaining a good yield of chlorate, and then a concentrated solution of this salt for the successful production of perchlorate.

The anode I.D. is about 8 amps. per dm². with a pressure of 6.5–7 volts. At a smooth platinum anode, the oxygen overvoltage is high, and discharge of oxygen is therefore retarded. One kg. of perchlorate requires about 3.5 K.W.H. Since sodium perchlorate is very soluble and hygroscopic, it is usually not isolated, but converted into the corresponding potassium or ammonium salt.

BROMINE AND BROMATES

The chief sources of bromine are the salt deposits at Stassfurt in Germany, and a few less well-known deposits in the United States. In addition to the usual method of preparing bromine by the chlorination of concentrated bromide mother-liquors, a certain amount is obtained by electrolysis of similar liquors containing a mixture of chloride and bromide.

Bromine is hydrolysed like chlorine on discharge, but not to the same extent, $\text{Br}_2 + \text{H}_2\text{O} = \text{HBrO} + \text{H}^+ + \text{Br}'$.

In the case of iodine there is no perceptible hydrolysis. The action of hydroxyl upon bromine in the neighbourhood of the anode may be thus expressed: $\text{Br}_2 + \text{OH}' = \text{HBrO} + \text{Br}'$, and the hydroxyl also acts upon the hypobromous acid thus: $\text{HBrO} + \text{OH}' = \text{BrO}' + \text{H}_2\text{O}$, while the hypobromite ion reacts with hypobromous acid to form bromate, thus—



¹ *Chem. Zeit.*, 1906, **30**, 213.

Bromate formation, however, takes place with a velocity which is one hundred times as great as that of chlorate formation.¹

The ratio of bromine to chlorine in the liquors used lies between $\frac{.05}{I}$ and $\frac{.006}{I}$; but if the current density be low there is no risk of chlorine discharge.

The *Kossuth Cell* for bromine consists of a long open cement trough containing a number of vertical carbon plate bipolar electrodes, which rest on the bottom of the trough and rise some distance above the level of the liquid. The electrolyte is compelled to take a zigzag course so that it passes over the surface of each electrode on its way through the cell. The end plates are connected with the source of current and the intermediate plates become electrodes by induction (bipolar).

The working temperature is 60° C., and the liquor becomes charged with bromine, which is volatile, while the equivalent of magnesium is precipitated in the form of hydroxide as the liquor traverses the cell. Each cell contains thirty electrodes, and takes about 100 amps. at a pressure of 100 volts. The amount of energy needed for producing one kg. of bromine is about 3 K.W.H.

The *Dow Cell* employed in America is a diaphragm cell, used apparently because the concentration of the chloride is rather high, and without a diaphragm considerable loss of bromine occurs by conversion into bromate by the chlorine which is discharged.

BROMATES

These are obtained by electrolysis of concentrated bromide solutions, at 40–50° C., containing a small amount of alkali bichromate; this latter produces a slight acidity which accelerates the reaction $2\text{HBrO} + \text{BrO}' = \text{BrO}'_3 + 2\text{H}' + 2\text{Br}'$, and the chromate also prevents the cathodic reduction of bromate and hypobromite.

¹ *Zeitsch. Elektrochem.*, 1897, **3**, 474; 1904, **10**, 802; 1905, **11**, 57; 1910, **16**, 321; *Journ. pr. Chem.*, 1901, **63**, 141.

Smooth platinum anodes and graphite cathodes are generally used, and I.D. at the anode is 10–15 amps. per dm².

IODINE

A patent was granted to Parker & Robinson,¹ in 1888, for the production of iodine by the electrolysis of alkali iodide containing a soluble sulphate and some free acid. The anode and cathode compartments were separated by a porous diaphragm, and carbon or platinum anodes with iron cathodes were used.

The cathode compartment was filled with caustic soda, and the anode compartment contained the iodide solution. The iodine which separated in the anode compartment was washed and dried.

In a process patented by B. Rinck² for the production of bromine and iodine, the electrolyte is a solution of alkali halide, and a diaphragm of asbestos is used. The anode compartment contains concentrated brine in which carbon plate anodes are immersed. The cathodes are of iron, and are immersed in the stream of electrolyte which slowly moves through the cell. The iodine or bromine is discharged at the anode and dissolves in the brine, from which it can be liberated when a sufficient concentration has been reached.

LITERATURE

Some Factors in the Cost of Hypochlorite Manufacture, *Int. Cong. of Applied Chem.*, 1912, Xa, 127.

Cells for the Production of Electrolytic Bleach, W. H. Walker, *Electrochem. Ind.*, 1902, 1, 439.

Elektrochemie Wasseriger Lösungen, Fritz Foerster, 1915, 2nd edition.

¹ Eng. Pat., 11479 (1888).

² D.R.P., 182298 (1906).

CHAPTER VII

PRODUCTION OF INORGANIC COMPOUNDS

CERTAIN substances can be produced by electrolysing a suitable alkali salt solution with an attackable anode. For example, if a solution of sodium sulphate be electrolysed, using a copper anode, the copper is dissolved, forming copper sulphate which in the neighbourhood of the cathode, where sodium hydroxide is formed, is converted into copper hydroxide. The copper is dissolved at the anode, and sodium hydroxide in equivalent quantity is formed at the cathode.¹

If the substance formed by solution of the attackable anode is insoluble, *e.g.* PbSO_4 , it collects on the bottom of the bath beneath the anode. Many patents have been issued or processes to manufacture the above-mentioned substances, and others of like nature. Most attention has been directed to the manufacture of white lead, and a paper by Burgess and Hambuechen should be consulted for a full account of the literature and patents devoted to this subject.² One of the chief difficulties met with in the preparation of white lead, was the incrusting of the anode with the precipitate there produced, which quickly stopped further action. Luckow showed that, in the case of lead sulphate, if a considerable quantity of a secondary salt such as sodium chlorate is used with the sodium sulphate, then the resulting sulphate of lead is formed a very short distance from the anode, and falls continuously to the bottom of the cell.³ White lead is

¹ *Zeitsch. anorg. Chem.*, 1896, **12**, 436.

² *Trans. Amer. Electrochem.*, 1903, **3**, 299.

³ *Zeitsch. Elektrochem*, 1903, **9**, 797. D.R.P., 91707 (1897); 105143 (1899).

precipitated continuously if a large excess of chlorate be used with the sodium carbonate.

The chlorate is termed the secondary salt and the carbonate is the primary salt. The mechanism of the reaction may be explained by assuming that the CO''_3 ions are "crowded out" by the ClO'_3 ions, so that the lead ions are able to travel a short distance towards the cathode before they are precipitated by contact with the CO''_3 ions.

For the production of white lead, Luckow recommends a 1.5 per cent. solution composed of 9 parts chlorate and 1 part carbonate of soda, and carbon dioxide is passed in during electrolysis. Anode I.D. is .25 amp. per dm^2 . at a pressure of 1.4 volts, and it is possible to produce 3.5-4 kgs. of white lead per K.W.H.¹

If sodium chromate be used instead of carbonate, then chrome yellow is precipitated, and chromic acid must be added continuously to replace that which is used up.

For the production of lead peroxide, the electrolyte is a dilute solution of 99.5 parts of Na_2SO_4 with .5 part of chlorate, and the bath is made slightly acid with sulphuric acid.

Cuprous oxide can be prepared by using a common salt solution as electrolyte containing a small quantity of alkali. The colour and uniformity of the product are improved by the addition of a little sodium nitrate to the bath.²

It has been shown that it is necessary to use dilute solutions of the precipitating salt, and a low current density in order to obtain regular precipitates and prevent the formation of crusts. Opposite conditions, however, high concentration of precipitating salt and high current density, give finely precipitated particles, so that these two opposing sets of conditions must be carefully regulated to produce a good white lead.³

The electrolytic production of zinc white has been attempted with some success.⁴

¹ *Trans. Amer. Electrochem.*, 1904, 5, 230. U.S. Pat., 644779 (1900).

² Eng. Pat., 14310 (1915).

³ *Zeitsch. Elektrochem.*, 1902, 8, 255; 1903, 9, 275; *Journ. Phys. Chem.*, 1909, 256, 332.

⁴ *Int. Cong. App. Chem.*, 1909, Sect. X, 45.

Percarbonates.—There is, no doubt, a good future for the electrolytic production of the salts of the per-acids.

Potassium percarbonate was first prepared by Constam and Hansen.¹ A saturated solution of the carbonate is cooled to -10° C., and electrolysed in a divided cell with platinum anodes. On a small scale, a porous pot forms the cathode compartment, and coiled round the outside is a platinum wire anode. Current density used is 30–60 amps. per dm^2 ., and during the electrolysis carbonate must be replenished to replace that converted into percarbonate.

Apparently, the carbonate in solution dissociates into the ions K^+ and KCO'_3 , and the reaction at the anode is represented by the following equation—



Hydroxylamine (NH_2OH).—Tafel showed, in 1903, that nitric acid may be reduced electrolytically to hydroxylamine, and a reasonable yield of the product obtained.² About this time several patents³ were taken out for the manufacture of hydroxylamine by electrolysis. Tafel showed that it is possible to use a 50 per cent. solution of H_2SO_4 or a 25 per cent. solution of hydrochloric acid with a lead cathode, the nitric acid being dropped in continually at a temperature not above 20° . A cathode of spongy tin was also found to work well, and the current density used is about .24 amp. per cm^2 ., but by stirring the liquor it is possible to raise the I.D. to .6 amp. per cm^2 .—

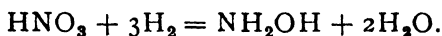

According to the French Patent 322943 (1903), an anode of platinum is used with a tin cathode. Sodium nitrate is dropped into the cathode compartment, and the anolyte is sodium chloride solution. The yield of hydroxylamine is said to be 60–80 per cent., and chlorine is produced at the same time.

¹ *Zeitsch. Elektrochem.*, 1896, 2, 137; 1897, 3, 445.

² *Zeitsch. anorg. Chem.*, 1902, 31, 289.

³ D.R.P., 133457, 137697 (1902); U.S. Pat., 727025 (1903).

French Patent 318978 (1903) also relates to the production of hydroxylamine by this method.

Hydrosulphites (Hyposulphites).—Sodium hydrosulphite is now made in large quantity by the electrolytic reduction of sodium bisulphite. The work of Jellinek has made clear the necessary conditions for obtaining a good yield.¹ He showed that the thiosulphate formed during the electrolysis is not due to reduction but to the decomposition of the hydrosulphite,

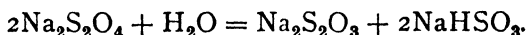

He therefore used a high current concentration, so that the current was large compared with the volume of electrolyte, and the hydrosulphite formation then took place at a much greater rate than its decomposition.

The older method of making hydrosulphite by zinc reduction of sodium bisulphite is no doubt electrolytic in principle, reduction taking place before hydrogen discharge owing to the high hydrogen overvoltage at zinc.

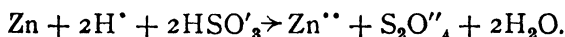

Jellinek used 5N.NaHSO₃, and obtained a 10 per cent. solution of Na₂S₂O₄, using 5 amps. for every 100 c.c. of catholyte. A low temperature is necessary, and hydrogen must not be allowed to leave the anode for the cathode, or the hydroxyl will react thus—

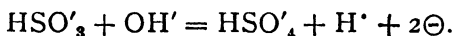

According to the German Patents 276058, 276059 (1912), dilute sodium bisulphite solution is electrolysed in the cathode compartment. A neutral salt may be added with good results, such as chloride or sulphate, but not a sulphite. Temperature is 0–5° C., and during electrolysis, sulphurous acid is added to the bisulphite solution.

According to D.R.P. 278588 (1912), the process is made continuous by circulating the bisulphite from a reservoir through the electrolytic vessels and back again. When the liquor becomes sufficiently concentrated, sodium hydrosulphite

¹ *Zeitsch. Elektrochem.*, 1911, 17, 157, 245.

separates but vigorous circulation from anode to cathode through the diaphragm is necessary.

According to the French Patent 467443 (1914), hydro-sulphite is produced by means of electrolytic zinc sponge.

Persulphuric Acid and Hydrogen Peroxide.—The electrolysis of sulphuric acid ($\Delta = 1.5$) at a low temperature, with high anode current density, yields persulphuric acid.

This process can be adapted to the formation of persulphates or hydrogen peroxide, as the latter substance is formed by hydrolysis of the persulphuric acid first formed.

Hydrogen peroxide is produced by the Consortium f. Elektrochemische Industrie, Nuremberg,¹ in this way, the persulphuric acid first formed being subsequently distilled under reduced pressure.

The process of Pietzsch and Adolp² involves the production of potassium persulphate by electrolysis of acid potassium sulphate, and the persulphate is subsequently distilled with sulphuric acid ($\Delta = 1.4$). A solution containing 20–30 per cent. of hydrogen peroxide is obtained.

No diaphragm is necessary for the production of persulphuric acid, but platinum electrodes should be used, and a high current density employed in a well-cooled solution. The addition of a small quantity of HCl or HF is beneficial.³ The resulting solution contains about 40 per cent. of persulphuric acid.

The production of persulphate has been studied by Elbs and Schönherr.⁴ In a diaphragm cell a concentrated solution of ammonium or potassium sulphate is used in the anode compartment, and a moderately strong solution of sulphuric acid in the cathode part. It is preferable to omit the diaphragm and to use a small amount of alkali chromate (about 2 per cent.) in the bath to prevent cathodic reduction.

The voltage required is about 7 volts, and 1 kg. of persulphate is given by 2.4 K.W.H.

¹ D.R.P., 199958, 217538, 217539 (1905).

² Eng. Pats., 23158, 23660 (1910).

³ *Zeitsch. Elektrochem.*, 1895, 1, 417.

⁴ *Zeitsch. Elektrochem.*, 1896, 2, 245.

Instead of acidifying the normal salt, the acid salt, KHSO_4 may be used, and the reaction is facilitated by the presence of chlorine and fluorine ions. The current density at the anode should be about 50 amps. per dm^2 . and the electrode should be of smooth platinum.

The hydrolysis of persulphuric acid takes place in two stages, the intermediate product being Caro's acid—

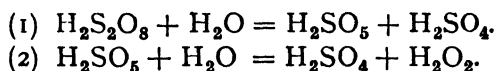

According to U.S. Patent, 1195560 (1915), hydrogen peroxide is made from ammonium persulphate which is formed by electrolysis and then heated under pressure to hydrolyse the persulphate.



The hydrolysed solution is then distilled under reduced pressure in an inert gas to separate the hydrogen peroxide. The ammonium sulphate is used again for the production of persulphate.

Potassium Permanganate.—The oxidation of the manganese melt (formed by fusion of MnO_2 , potash and potassium chlorate) is now often effected by electrolysis.

In the older methods chlorine or carbonic acid is used to bring about the following changes—

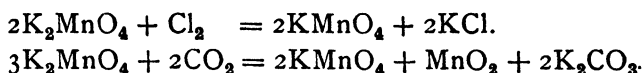

By electrolytic oxidation the following change is brought about—

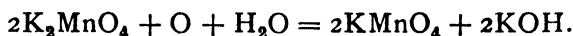

The advantage of this process is that no manganese dioxide is formed, and the potash produced can be used again in the fusion process.

The first industrial cell was devised by Schering,¹ who used a diaphragm of cement to separate the two compartments.

The cell of the Salzbergwerke neu Stassfurt² is shown in

¹ D.R.P., 28782 (1884).

² D.R.P., 101710 (1898).

section in Fig. 57. The bath contains a solution of potassium manganate (K_2MnO_4) which forms the anodic liquor, and which is replenished by the gradual solution of fused product placed in the metal baskets P. The cathodes are contained in porous compartments of cement, and the iron anodes dip into the liquor between the porous cathode cells and the metal baskets.

The production of one kg. of permanganate requires about .7 K.W.H. Voltage is about 2.8 volts, cathodic I.D. is .85 amp. per cm^2 . and anode I.D. is .085 amp. per cm^2 . Nickel electrodes are found very satisfactory.¹

*Potassium Ferricyanide.*²—This substance which was

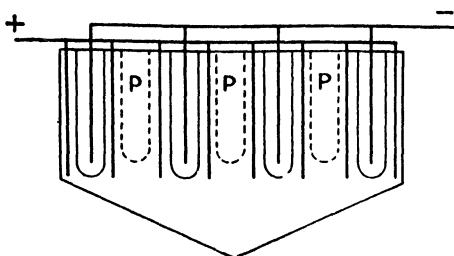
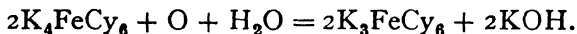

FIG. 57.

formerly produced by the action of chlorine upon potassium ferrocyanide is now generally made by electrolytic oxidation—



A saturated solution of the ferrocyanide is used, made slightly alkaline, at a temperature of 20° C.

*Nitric Acid by Electrolysis of Peat Deposits.*³—The process invented by Nodon seems to have been adopted in a few districts where peat deposits exist. It depends upon the fact that in such deposits there is a considerable quantity of calcium nitrate dissolved in the water. Carbon anodes and iron cathodes are sunk into the deposit, connected up in sets, and drainage arranged to convey the nitric acid, produced at

¹ *Zeitsch. Elektrochem.*, 1910, 16, 170.

² *Zeitsch. anorg. Chem.*, 1904, 39, 240. Eng. Pat., 7426 (1886). *Electrical Review*, 1893, 32, 216.

³ *Met. and Chem. Eng.*, 1914, 12, 107.

the anodes, to storage tanks. The nitrifying bacteria are not destroyed by the process, and continue their work, uninterruptedly, of converting the nitrogenous matter in the peat into nitrates.

*Sewage Disposal.*¹—Electrolysis has been applied to

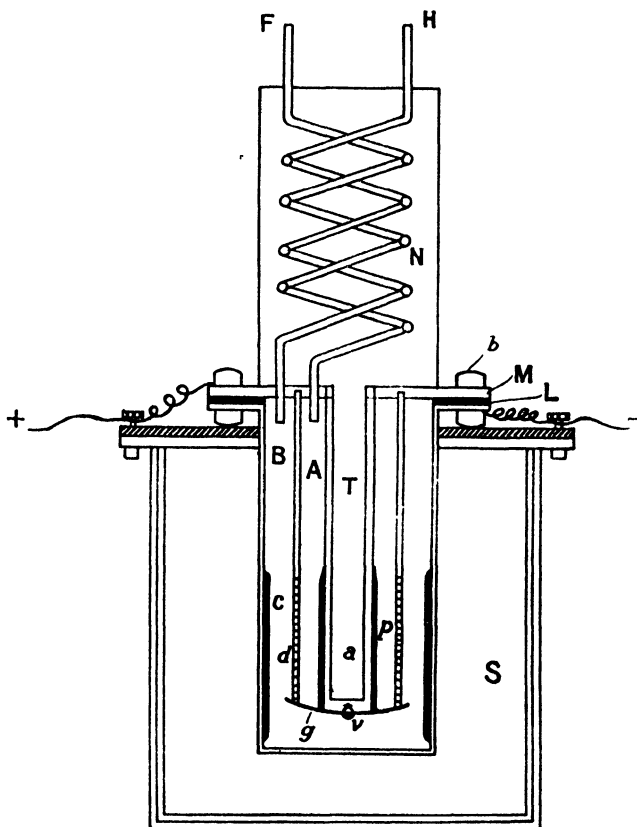

FIG. 58.

sewage disposal in the Landreth process employed at New York. Treatment with lime, and a subsequent electrolysis in special towers or partitioned tanks render the fluid innocuous.

Fluorine.—This element was isolated by Moissan in 1887

¹ *Met. and Chem. Eng.*, 1915, 18, 735, 993.

by electrolysing anhydrous hydrofluoric acid containing potassium fluoride, in an apparatus made entirely of platinum. He subsequently proved that copper may replace platinum as a containing vessel since it becomes coated with copper fluoride which protects the metal from further corrosion. Apparatus was designed by Moissan for producing fluorine on the large scale, and the plant is made by MM. Poulenc Frères of Paris.¹ The hydrofluoric acid is contained in a copper vessel B (Fig. 58), the inner surface of which, C, acts as cathode. B is inside a larger vessel S, which contains a cooling mixture, and it is covered by a copper lid M, from which it is insulated by a rubber ring L, and also by rubber tubes round the bolts *b*. A is a copper tube perforated below by a number of small holes *d*. This serves as a diaphragm between the cathode and the anode *p*, which is of platinum and surrounds the copper tube T, which communicates with the upper vessel N containing a cooling mixture. The bottom of the anode chamber is covered by a copper plate *g* which is fastened to T by copper screws *v*. The diaphragm which is in electrical connection with the anode becomes at first covered with a layer of copper fluoride, and then being insulated, fluorine is evolved from the anode. Copper tubes H, F, serve to carry away the evolved hydrogen and fluorine.

¹ *Zeitsch. Elektrochem.*, 1900, 7, 150.

CHAPTER VIII

PRODUCTION OF ORGANIC COMPOUNDS

MANY organic compounds may be produced by electrolysis, but since this branch of manufacturing chemistry has had its chief home in Germany, it is difficult to find out to what extent electrolytic methods have actually been applied. During the twenty-five years ending 1910, for example,¹ about 100 patents were taken out for the preparation of organic products by electrolysis. Of these, 89 were German, 6 were French, 3 English and 4 American, and 39 of the German patents referred to the electrolytic reduction of organic compounds. This branch of electrochemistry has not received the attention which it deserves in countries other than Germany. In these processes there are many variables to be taken into account, such as, current density, electrode material, overvoltage, etc., which indicate complexity, but the complexity foreshadows great possibilities.

A brief account will now be given of processes well established on a large scale, and also a summary of original work and patent literature which will indicate the direction that progress in this branch has taken.

Iodoform.—The older method of producing this important antiseptic, by the action of iodine upon alcohol in the presence of sodium carbonate, was based upon the following reaction—

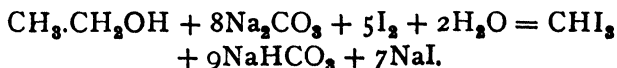

Only about 30 per cent. of the iodine goes to form iodoform,

¹ *Met. and Chem. Eng.*, 1915, 13, 211.

but by electrolysing alkali iodide in presence of alcohol the following reaction takes place—

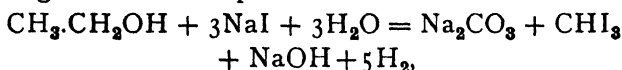

and all the iodine used goes into the iodoform.¹ The conditions for preparing iodoform in this way are as follows:² Sodium carbonate 50 parts and potassium iodide 170 parts, are dissolved in 96 per cent. alcohol, 100 parts. The anode should be of smooth platinum, and the cathode of lead is encased in parchment or some suitable diaphragm material. Working temperature should be 60–70° C., anode I.D. 1–2 amps. per dm², and voltage 2–2.5 volts. Iodoform is produced at the rate of 1.3 gms. per amp.-hour, or 500 gms. per K.W.H., and the current efficiency is about 90 per cent. A satisfactory yield of iodoform is also obtained if acetone be used in place of alcohol.

Bromoform can be obtained in a similar manner if alkali bromide be electrolysed in the presence of alcohol or acetone.³

Anthraquinone.—The first step in the direction of applying electrolytic methods to the oxidation of anthracene was made when the “spent” chromic acid liquor was revived by oxidation, in the anode compartment of a two compartment cell, being then returned to the oxidising vessel for converting a fresh quantity of anthracene to the quinone. The conditions laid down by the Farbwerke Höchst Patent⁴ were: Solution to contain about 100 gms. of Cr₂O₃ per litre with 350 gms. of sulphuric acid, current density at anode of lead about 3 amps. The anode functions as a PbO₂ electrode which Müller and Soller have shown acts catalytically.⁵

The reaction taking place is—

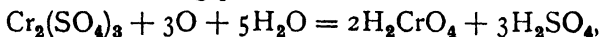

and a current efficiency of about 80 per cent. is obtained.

¹ D.R.P., 29771 (1884); Eng. Pat., 8148 (1884).

² *Zeitsch. Elektrochem.*, 1897, **3**, 268.

³ *Amer. Chem. Journ.*, 1902, **27**, 63; *Zeitsch. Elektrochem.*, 1904, **10**, 409; *Trans. Amer. Electrochem.*, 1905, **8**, 281.

⁴ D.R.P., 103860 (1899). *Zeitsch. Elektrochem.*, 1900, **6**, 290, 308.

⁵ *Zeitsch. Elektrochem.*, 1905, **11**, 863; 1913, **19**, 344.

Askenasy has shown that the diaphragm may be dispensed with if certain salts are added to the solution, such as sulphate or oxalate of sodium, or magnesium sulphate.

In the process used by Farbwerke vorm. Meister Lucius und Brüning,¹ chromic acid is not used, but instead, 20 per cent. sulphuric acid electrolyte containing 2 per cent. of cerium sulphate. The temperature is kept at 70–100° C., a lead-lined vessel forms the anode and the liquor is well stirred.

Anode I.D. is 5 amps., at a pressure of 2·8 to 3·5 volts, and current efficiency is nearly 100 per cent.

Vanillin.—This substance is produced by electrolytic oxidation of the sodium salt of isoeugenol, by v. Heyden Nchfg.² in Germany. A 15 per cent. solution of the sodium salt in excess of soda fills the anode cell, and the cathode chamber contains 10–20 per cent. caustic soda; working temperature 60° C. The anodes of PbO₂ act as catalysts, since platinum anodes merely evolve most of the oxygen without changing the substance.³

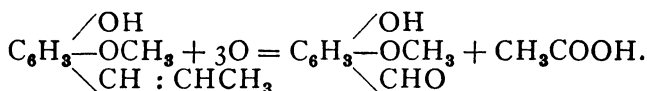

Isopropyl Alcohol.—This is produced by the reduction of acetone. The claims of Merck's patent have been verified by Elbs.⁴ The cell is divided into two compartments, and with a mercury cathode the yield of alcohol is good, very little pinacone being formed.

Chloral is produced when alcohol is allowed to drop into the anode compartment of a cell in which potassium chloride is electrolysed.⁵

Saccharine is produced by the electrolytic oxidation of *o*-toluene sulphonamide⁶—

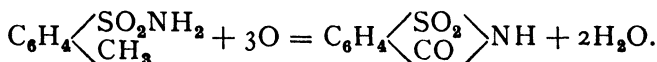

¹ *Electrochem. Ind.*, 1904, 2, 249.

² D.R.P., 92007 (1895). *Electrochem. Review*, 1900, 1, 31.

³ *Electrochem. Ind.*, 1904, 2, 452. Austrian Pat., 34562 (1908).

⁴ D.R.P., 113719 (1899). *Zeitsch. Elektrochem.*, 1902, 8, 783.

⁵ *Elektrochem. Zeitsch.*, 1894, 1, 70.

⁶ D.R.P., 85491 (1895).

Sugar juices can be purified by electrolysis.¹

The processes thus enumerated are interesting and important applications of electrolysis to the production of organic compounds. A full account of the electro-chemistry of organic compounds will be found in the treatise by Dr. Löb² on the subject.

The following summary indicates broadly the main provinces which have been explored experimentally, and, judging by the patent literature, this pioneering work has been utilised industrially.

THE REDUCTION OF NITRO-COMPOUNDS

The numerous reduction products of nitro-benzene and its homologues can be obtained by electrolytic reduction. Many patents have been issued specifying the use of particular cathode metals.

Elbs has proved that with attackable cathodes reduction proceeds further than with unattackable cathodes, such as platinum nickel or mercury.

The catalytic action of various salts in solution has also been proved of great use in aiding or directing cathodic effects.

Oxidation, although it has received much attention, has not the same degree of importance as reduction. The side chains of aromatic compounds can be oxidised in such a manner as to give the groups -CH₂OH, -CHO, -COOH.

Many dye-stuffs have been prepared by electrolytic reduction or oxidation. A few examples are—

p-Rosaniline, by reduction of *p*-nitro-diamidotriphenylmethane in concentrated acid, D.R.P. 84607 (1894).

Orange dyes by using as cathode liquor an alkaline solution of the yellow condensation product of *p*-nitrotoluene sulphonic acid, Eng. Pat., 22482 (1895).

The electrolytic diazotisation of amines and preparation of azo-dyes was discovered by Löb.³ The amine, nitrite, and

¹ *Jahrbuch der Elektrochemie*, 1901, 8, 628.

² *The Electro-chemistry of Organic Compounds* (1905).

³ *Zeitsch. Elektrochem.*, 1904, 10, 237.

coupling compound, in neutral or alkaline solution, form the anode liquor, and the mixture is electrolysed, using a platinum or some other unattackable anode. The anodic mixture should be stirred during electrolysis and cooling is not necessary, since, at the moment of diazotisation by the discharged nitrite ion, the diazo-compound condenses with the phenolic coupling material. For example, by using an anode liquor containing the sodium salt of sulphanilic acid, nitrite and β -naphthol, the dye, Orange II, is obtained, similarly dianisidine blue is formed from dianisidine, nitrite and β -naphthol.

The electrolytic oxidation of amines results in the production of colouring matters, and many have been prepared in this way. Aniline black is obtained from aniline by this method; also naphthylamine violet from the base. Mixtures of the bases also have been oxidised with similar results.¹

The reduction of the carbonyl group to (CHOH) is well illustrated by the formation of borneol from camphor and also benzhydrol from benzophenone.

Substitution by the halogen elements also is very general as shown by the formation of chloral, chloroform, bromoform, chloraniline and the electrolytic method of carrying out Sandmeyer's reaction.²

The application of electrolysis to the production of organic compounds awaits development in many directions and offers a rich field for investigation.

¹ *Zeitsch. angew. Chemie*, 1894, p. 107.

² *Zeitsch. Elektrochem.*, 1901, 7, 877.

SUBJECT INDEX

- ACCUMULATORS, 20
Acker cell for caustic soda, 112
Alternating current, transmission of, 27
—— use of, in electrolysis, 52
Alumina, purification of, 55
Aluminium, production of, 53
Ammeter, 28
Anodes, 13
Anthraquinone, production of, 140
Antimony, production of, 77
—— refining of, 45
Ashcroft process for sodium, 72
- Balbach-Thum silver process, 48
Bayer process for purifying alumina, 55
Becker process for sodium, 71
Bell process for caustic soda, 110
Bett's lead-refining process, 42
Billiter-Leykam cell for caustic soda, 111
Billiter-Siemens cell for caustic soda, 102
Bismuth, production of, 78
Borcher's cell for electrolysis of fused salt, 72
Bromine and bromates, production of, 127
Bromoform, 140
Browne process for nickel, 65
Brunner, Mond & Co., process for zinc, 61
- Cadmium, refining of, 45
Calcium, production of, 75
Calorie, electrical equivalent of, 7
Castner cell for caustic soda, 105
—— process for sodium, 66
Castner - Kellner cell for caustic soda, 106
Cataphoresis, 9
Cathodes, 13
Caustic soda from brine, 91
—— from fused salt, 112
Chloral, preparation of, 141
Chlorates, production of, 116, 123
Chlorine and caustic soda, 91
Chrome yellow, preparation of, 131
Chromic acid, production of, 141
Colloids in electrolysis, 10
Commutator, 24
Copper, analysis of crude, 34
—— production of, 57
—— refining of, 33
Coulomb, 6
Cryolite, density of fused, 55
Cuprous oxides, production of, 131
Current efficiency, 11
—— measurement, 28
Cyanide gold-refining process, 52
- Daniell's cell, 17
Darling process for sodium, 69
Decomposition voltage, 7, 8, 80
Diaphragm cells for caustic soda, 92
Diaphragms, 13
Dietzel silver refining process, 49
Dow cell for bromine, 128
Dry cells, 18
Dyestuffs, production of, 142
Dynamo, construction of, 23
- Edser-Wilderma cell for caustic soda, 109
Electrical osmosis, 9
—— units of measurement, 6
Electrodes, 12
Electrolysis, 1
—— bath, 12
Electromotive force, 6
Energy efficiency, 11
- Faraday's laws, 3
Filter-press cells for electrolysis of water, 82, 88
Finlay cell for caustic soda, 99
Fluorine, production of, 137
Fluosilicate lead-refining process, 43
Foul electrolytes, analysis of, 40
Fuel cells, 18

- Garuti process for hydrogen and oxygen, 85
Gibb's process for chlorate production, 124
Gold refining, 50, 52
Griesheim Elektron cell, 92
- Haas-Oettel cell for hypochlorite, 121
Hargreaves-Bird cell for sodium carbonate, 94
Heat of formation, 7, 79
Hermite process for hypochlorite, 122
Hoepfner process for copper, 59
— process for nickel, 64
— process for zinc, 61
Hydrogen and oxygen, production of, 79
— peroxide, production of, 134
Hydrosulphite, production of, 133
Hydroxylamine, production of, 132
Hypochlorites, production of, 116
- International oxygen cell, 87
Iodine, production of, 129
Iodoform, production of, 139
Ions, 2
Iron refining, 45
Isopropyl alcohol, production of, 141
- Joule, value of the, 7
Joule's law, 3
- Keith's process for lead refining, 42
Kellner air-pressure cell, 107
Kellner cell for hypochlorite, 119
Kilowatt, value of the, 7
Kossuth cell for bromine, 128
- Landreth process for sewage disposal, 137
Laszcynski process for zinc, 61
Lead, electrolytic production of, 63
— peroxide, 131
— refining, 41
Leclanché cell, 17
Lelande cell, 18
Le Seur cell for caustic soda, 101
Lithium, production of, 77
Load factor, 31
- MacDonald cell for caustic soda, 101
Magnesium, production of, 74
- Mansfeld process for production of copper, 58
Marchese process for production of copper, 57
Mercury cells for caustic soda, 103
Metal fog, 14, 56
Moebius silver-refining process, 46
Molten electrolytes, use of, 14
Motor generator, 27
- Nickel, production of, 64
Nitric acid from peat, 136
- Ohm, the unit of resistance, 6
Ohm's law, 6
Osmotic pressure, 4
Outhenin-Chalandre cell for caustic soda, 95
Overvoltage, 9
Oxidation of organic compounds, 142
Ozone, production of, 89
- Peat, dehydration of, 9
Percarbonates, production of, 132
Perchlorate, production of, 116, 126
— process for lead refining, 44
Permanganate, production of, 135
Persulphuric acid, production of, 134
Polarisation, 17
Potassium ferricyanide, 136
Potential, 6
Power costs, 30
— sources, 29
— transmission, 27
Primary cells, 16
- Reduction of organic compounds, 142
Rhodin cell for caustic soda, 108
Rotary converter, 26
- Saccharine, production of, 141
Salom's lead process, 63
Schmidt process for hydrogen and oxygen, 82
Schoop's process for hydrogen and oxygen, 84
— process for hypochlorite, 122
Schuckert cell for hypochlorite, 121
— process for hydrogen and oxygen, 87
Secondary cells, 19

- Sewage purification by electrolysis, 137
Siemens and Halske process for copper, 58
Silver, refining of, 46
Slimes from copper refining, 39
Sodium chloride, electrolysis of, 90
— from fused caustic soda, 66
— from fused salt, 72
— from fused sodium nitrate, 69
— contact electrode process for, 71
Solvay-Kellner cell for caustic soda, 107
Sugar juice, electrolytic purification of, 142
Swinburne and Ashcroft process for zinc chloride, 62
Thermopiles, 20
Tin, refining of, 44
Tommasi process for lead refining, 42
Townsend cell for caustic soda, 96
Transformers, 27
Units, electrical, 6
Vanillin, preparation of, 141
Vautin cell for caustic soda, 114
Voltaic cell, 16
Voltmeter, 28
Water, electrolysis of, 79
— power, 31
Watt, electrical value of the, 6
Weston cadmium cell, 6
White lead, production of, 130
Whiting cell for caustic soda, 107
Wohlwill process of gold refining 50
Zinc chloride, dehydration of, 62
— —, electrolysis of fused, 62
— electrolytic production of, 60
— white, electrolytic production of, 131

INDEX OF AUTHORS AND NAMES OF FIRMS

- ACKER, 112
 Addicks, 45
 Allmand, 99
 American Smelting and Refining
 Co., 45
 Anaconda Copper Co., 38, 61
 Archibald & Finlay, 99
 Arrhenius, 5
 Ashcroft, 31, 62, 72

 Baekeland, 98
 Balbach Works, 48
 Bancroft, 41
 Betts, 10, 42, 78, 126
 Bolton & Sons, 33
 Borchers, 42, 75, 78
 British Aluminium Co., 54
 — Thomson-Houston Co., 2
 Brunner, Mond & Co., 61
 Burgess, 130

 Canadian Copper Co., 65
 — Smelting Works, 43
 Carrier, 71, 74
 Castner, 66, 104
 — Alkali Co., 66, 108
 — Kellner Co., 63, 66, 104
 Clevenger, 52
 Consortium f. Elektrochemische
 Industrie, 134
 Constam, 132
 Couleru, 127

 Darling, 69
 D'Arsonval, 81
 Davy, 1
 Del Proposto, 85
 Deville, 53
 Dietzel, 49
 Donnan, 31

 Edser-Wildermann, 109
 Elbs, 134, 141, 142

 Electrical Lead Reduction Co., 64
 Electrolytic Alkali Co., 94
 Elkington, 23, 33
 Elliot's Metal Co., 33

 Faraday, 1, 2, 23
 Farbwerke vorm. Meister, Lucius
 & Brüning, 141
 Foerster, 78, 123, 129
 Frary, 77

 Garuti, 85
 Gibbs, 124
 Goodwin, 77
 Gramme, 23
 Great Falls Refinery, 40
 Griesheim Elektron Co., 71
 Grünauer, 63

 Haber, 56, 115
 Hall, 53
 Hambuechen, 130
 Hermite, 120
 Héroult, 53
 Hevesy, 69
 Hoff van't, 4

 Imhoff, 124
 International Oxygen Co., 87

 Jellinek, 133

 Keith, 42
 Kellner, 107, 119
 Kershaw, 31, 32, 102, 115

 Laszcynski, 57, 61
 Latchinoff, 81
 Leblanc, 71
 Lederlin, 125
 Le Seur, 101
 Löb, 142

148 INDEX OF AUTHORS AND NAMES OF FIRMS

- Lorenz, 15, 62, 75
 Luckow, 130
- Macdonald, 101
 Mansfeld Copper Co., 58
 Marchese, 57
 Moebius, 46
 Moissan, 137
 Morse, 4
 Mott, 77
 Moynot, 115
 Mueller, 11, 123
- Neumann, 56
 New York and Pennsylvania Co.
 Paper Mills, 101
 Niagara Alkali Co., 102
 Nichol's Refinery, 35
 Nodon, 136
 Norddeutsche Affinerie, 38, 50
- Oettel 74, 121
 Olson, 56
 Orford Copper Co., 66
- Parker & Robinson, 129
 Pascal, 56
 Patten, 77
 Pfeffer, 4
 Philadelphia Mint, 47, 51
 Pietzsch & Adolf, 134
 Plato, 75
 Poplar Borough Council, 122
 Poulenc Frères, 138
 Pring, 32
 Pyne, 55
- Raritan Copper Works, 48
 Rhodin, 108
 Richards, 52, 74, 115
 Richardson, 56
 Rinck, 129
 Ruff, 75, 77
- Sadtler, 63
 Salom, 63
 Salzbergwerke neu Stassfurt, 135
 Savelsburg & Wannschaff, 65
 Schering, 135
 Schmidt, 82
 Schoop, 84, 122
 Schuckert, 87, 121
 Seward & von Kugelgen, 73, 76
 Siemens & Halske, 52, 58, 77, 102,
 126
 Siemens, Schuckert Co., 121
 Spear, 10
 Standard and Colorado City
 Works, 101
 Steinhardt & Vogel, 62
 Swan, 32
 Swinburne, 62
- Tafel, 132
 Taussig, 95
 Thompson, 56
 Threlfall & Wilson, 126
 Tommasi, 42
 Townsend, 96, 115
 Tronson, 77
 Tucker, 77
 Tuttle, 51
- Ulke, 41
 United Alkali Co., 62, 73
- Volta, 16
- Walker, 52, 129
 Watt, 33, 91
 Whiting, 107
 Whitney, 77
 Winteler, 126
 Wohler, 76
 Wohlwill, 50
 Woolrich, 23

