

TEXT FLY IN THE  
BOOK

UNIVERSAL  
LIBRARY

**OU\_164561**

UNIVERSAL  
LIBRARY





**OSMANIA UNIVERSITY LIBRARY**

Call No. 541.2  
ASSN  
Author Mitchell, H.G.  
Accession No. 18871  
Title General Science

This book should be returned on or before the date last marked below.

---



THE  
NEW CHEMISTRY





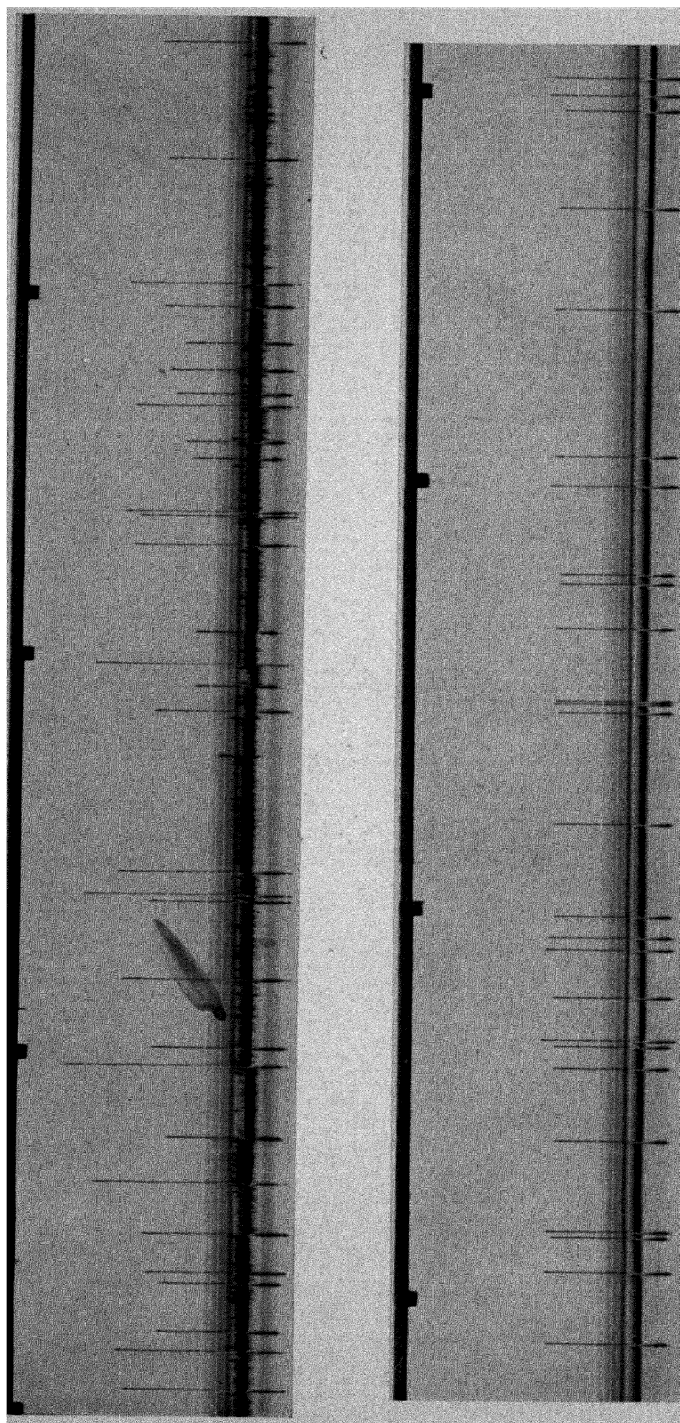

OSCILLOGRAPH RECORDS OF SINGLE PARTICLES, MADE BY PROFESSOR CHADWICK  
*Above* : PROTONS. *Below* : ALPHA PARTICLES

(The sensitivity of the instrument has been reduced in the case of the alpha particles)

THE  
NEW CHEMISTRY

BY

E. N. DA C. ANDRADE

D.Sc., Ph.D., F.R.S.

QUAIN PROFESSOR OF PHYSICS  
UNIVERSITY OF LONDON

LONDON

G. BELL & SONS, LTD

1936

*Dedicated to  
Professor C. D. Ellis, F.R.S.  
an old friend  
who knows all about these things  
without believing  
that  
nothing else matters*

PRINTED IN GREAT BRITAIN  
BY R. & R. CLARK, LIMITED, EDINBURGH



## PREFACE

It is, says the anonymous writer of *The Laws of Chance*, which is no larger than the present work, thought as necessary to write a preface before a book, as it is judged civil, when you invite a friend to dinner, to proffer him a glass of hock beforehand for a whet ; and though times less fastidious demand cruder drinks, the custom persists, perhaps rather with a view to blunting the palate than whetting the appetite.

Let me say, then, that early this year Sir Almoth Wright was kind enough to invite me to address his celebrated Post-graduate School, in the Institute of Pathology and Research at St. Mary's Hospital, on a topic connected with modern physics. The present booklet, prepared at the suggestion of indulgent, or indifferent, friends, is a development of the lecture which I then gave. The intention is to provide such an account of the recent work on atomic transmutation as may be read by all who have scientific tastes. It is without any touch of mathematics, and may, I hope, be easily digested.

## PREFACE

It has been suggested to me that it would be well to give a list of all the nuclear reactions which have so far been effected. The subject is, however, already so far advanced that the practical difficulties of preparing such a list are as great as the practical uses would seem to be small. Nobody writing a brief introduction to chemistry at the time of Dalton, say, would have been expected to list all the inorganic reactions then known, as an aid to the discussion of chemical principles. In any case, after examining the proposal sufficiently far to have made a start, I have come to the conclusion that it is to be classed with those high-sounding political plannings, concerning which one may ask anything except what useful purpose they are to serve.

I have never felt the need of apology for writing that which, if superfluous, nobody is compelled to read ; which, if common, will do no harm to manners or morals ; which, if neglected, can lead to no graver strife than the intestine altercation of publisher and author. I offer this, then, with a civil word to all well-wishers, and must endeavour to bear the censure of others with as much outward composure as I can muster.

E. N. DA C. ANDRADE

*October 1936*

## LIST OF PLATES

PLATES

I.	Oscillograph records of single particles	<i>Frontispiece</i>
II.	The high voltage apparatus of Drs Cockcroft and Walton, in the Cavendish Laboratory .	29
III.	The cyclotron, showing the large magnet .	32
IV.	Interior of cyclotron chamber . . .	33
V.	A beam of $5\frac{1}{2}$ million volt deuterons, shooting out into air . . . . .	34
VI.	The electrostatic generator at the Carnegie Institute, Washington . . . . .	36
VII.	The transmutation of lithium into helium by proton bombardment . . . . .	38
VIII.	The transmutation of boron into helium by proton bombardment . . . . .	40



## *The New Chemistry*

UNTIL the end of the last century few hypotheses seemed to be as well established as that of the chemical element, defined as a fundamental substance which could by no method be converted into any other substance. The alchemists had held that metals could be transmuted into one another, and, in particular, that base metals could be changed into gold, this belief being as much due to a mystical philosophy as it was to a desire for material gain. From the time of Robert Boyle, however, the impossibility of such a transmutation of chemical elements became, to all intent, more and more firmly established, and the atom of an elementary substance was held to be in its very nature unique and unalterable. Such a great and far-seeing pioneer as Clerk Maxwell was certain that atoms were unmakeable and unbreakable, as witness the following passage from his Encyclopaedia article "Atom", each sentence of which is directly opposed to what we now know to be the case.

## THE NEW CHEMISTRY

“ The formation of the atom <sup>1</sup> is therefore an event not belonging to that order of nature under which we live. It is an operation of a kind which is not, so far as we are aware, going on on earth or in the sun or the stars, either now or since these bodies began to be formed. It must be referred to the epoch, not of the formation of the earth or of the solar system, but of the establishment of the existing order of nature, and till not only these worlds and systems, but the very order of nature itself is dissolved, we have no reason to expect the occurrence of any operation of a similar kind.

“ In the present state of science, therefore, we have strong reasons for believing that in an atom we have something which has existed either from eternity or at least from time anterior to the existing order of nature.”

The first doubts as to the essential permanence of atoms arose with the discovery of radioactivity, when it was shown that certain heavy atoms, notably those of uranium, went through a series of changes, ultimately becoming atoms of lead. This led to the opinion that there were certain exceptional kinds of atoms, all very heavy, which were

<sup>1</sup> Clerk Maxwell uses the word “ molecule ” here and in the second paragraph, but the sense in which he is using it is not that current today, but corresponds to what we mean by atom.

## THE NEW CHEMISTRY

inherently unstable, and broke down spontaneously, the breakdown, both as regards rate and nature, not being influenced by any forces accessible in the laboratory. Transmutation, it was held, was the property of certain special kinds of atoms only, existing in nature, and could be neither inhibited in these species of atoms, nor initiated in other species. Still, a great advance had been made, and men of science admitted that atoms were not necessarily unchangeable entities.

Since the war, largely due to the efforts of Rutherford and his school, the deliberate transmutation of atoms in the laboratory has been shown to be possible in an ever-increasing number of instances, and has developed into a special field of scientific research. What is in question is, it is true, not a transmutation of weighable bulks, but of extremely minute quantities, which can be detected only by the extraordinarily delicate means of detection now available. The principle, however, is just as well established by small as by large quantities. Lithium has, for instance, been transformed into helium, and nitrogen into oxygen. Moreover, unstable atoms have been deliberately manufactured, which, after their formation, break down with the emission of radiations of particular kinds, just as do the naturally radioactive atoms.

## THE NEW CHEMISTRY

The formation of one kind of known atom from another, and the manufacture of new kinds of atoms hitherto unknown to chemistry, is, then, a new and rapidly developing science, and it is to this that I have applied the name **THE NEW CHEMISTRY**, in contrast to the old chemistry, which deals with the formation of one kind of molecule from other kinds of molecules, and the manufacture of new types of molecules.

Let us first consider for a moment certain basic principles of the old chemistry. The chemistry of the combination of atoms into molecules, and of groups of molecules into other groups of molecules—that is, of chemical reactions in the usual sense—is governed by two fundamental laws, the conservation of mass and the conservation of energy. The first of these is stressed in all elementary books, the second is, perhaps, less emphasised. When a chemical reaction takes place, heat is, in general, either absorbed from the surroundings or given out—the temperature of the products can be kept the same as that of the reacting compounds only by supplying or taking away energy. This is explained, of course, by saying that the internal energy of the substances on one side of the equation is different from that of those on the other, the heat of reaction representing the difference.

## THE NEW CHEMISTRY

In itself, this would seem to take us little further, since difference of internal energies is, so far, nothing but a convenient way of naming an unknown origin for the heat. What lends precision to the conception of internal energy is that, starting with a given set of compounds, we can arrive at a second set of compounds by different steps, either, for example, in one reaction, or alternatively, by way of intermediate reactions, each with its own heat of reaction. The total heat that is formed when the one set of compounds is changed to the other is found to be independent of the way in which the change is carried out : the heat liberated, for instance, in the direct reaction is equal to the algebraic sum of the heat liberated in the alternative step-by-step reactions. This means that we can attribute an energy to each chemical compound,<sup>1</sup> and that, whatever reactions take place, the heat liberated or absorbed can be calculated from the energies of the compounds involved, on the supposition that energy is conserved. The conservation of energy has, then, a precise meaning for chemistry.

To take a simple example, let us consider the burning of carbon (diamond) to carbon dioxide, diamond being specified because the energy of

<sup>1</sup> Except for an unknown additive constant.

## THE NEW CHEMISTRY

amorphous carbon is different from that of the crystalline form.<sup>1</sup> We have

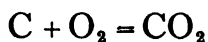

where the most accurate weighing possible has shown the masses of the diamond and oxygen to be equal to that of the carbon dioxide formed. The full equation is, however,

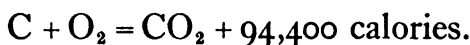

The calories in the equation represent the difference in energy between a gram-molecule of carbon dioxide, and the equivalent uncombined quantities of carbon and oxygen. That this view is valid is proved by the fact that, however we build up carbon dioxide from carbon and oxygen, we find the same amount of energy set free. We can, for instance, carry out the process in two stages :

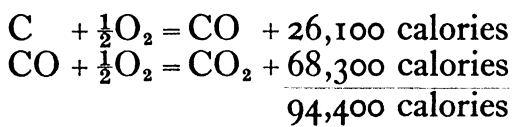

and, as will be seen, starting with the one set of chemicals, and ending up with the other, we have the same heat developed. It is justifiable, then, to attribute a given energy of combination to different molecules, and the thermodynamics of chemistry is

<sup>1</sup> The 94,400 calories in the equation below, which is the figure for diamond, is given as 96,960 for charcoal.

## THE NEW CHEMISTRY

based upon the supposition that the conservation of energy applies to these energies of combination.

The combination of nuclei, which is the new chemistry, does not obey either of the two separate laws of ordinary chemistry, the conservation of mass or the conservation of energy. We will take a typical simple reaction, the combination of a hydrogen nucleus, or proton, as it is called, with a lithium nucleus, to form two helium nuclei. First of all, however, we need a word as to our notation. It is a familiar fact that atoms chemically the same can have nuclei of different masses, the so-called isotopes. The chemical nature of the atom is given by the nuclear charge, which we write as a subscript on the left, thus :  ${}_3\text{Li}$ , any atom of charge 3 being a lithium atom. There are, however, two isotopes of lithium, of mass 6 and 7 respectively. We write the mass as a superscript on the left, thus  ${}^7_3\text{Li}$  for the 7 isotope of lithium. This leaves space for a right-hand subscript to give the number of atoms in a molecule, as in ordinary chemical equations.

The masses of the isotopes are, as shown by Aston, not exact whole numbers, in terms of the common isotope of oxygen taken as 16,<sup>1</sup> but

<sup>1</sup> Oxygen is now known to consist of three isotopes of mass number 16, 17 and 18 respectively, but the first is by far the most common.

## THE NEW CHEMISTRY

have always a small fractional part, the number given in the symbol being the whole-number part.

Thus the mass of beryllium 9,  ${}^9_4\text{Be}$ , is really not exactly 9, but 9.0149, the mass of hydrogen is not 1, but 1.0081, and the mass of helium is not 4, but 4.0039. The whole-number part is called the mass number.

Let us now write down the equation for the hydrogen + lithium = helium transformation, which is

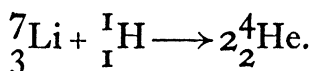

The masses on the left-hand side add up to 8.0261, while twice the helium mass is 8.0078. There is, therefore, a discrepancy: apparently a mass of 0.0183 is absolutely lost in the reaction.

Not only is the conservation of mass violated in this way, the conservation of energy is equally invalid. The two helium nuclei fly off with a high kinetic energy, which can be calculated from their range, and turns out to be  $2.71 \times 10^{-5}$  erg per lithium atom transmuted, which means  $1.64 \times 10^{19}$  ergs per gram atom transformed. Against this we have to set the energy of the proton effecting the transmutation, but this is comparatively small, so that substantially  $1.64 \times 10^{19}$  ergs are apparently

## THE NEW CHEMISTRY

gained from nowhere in the transmutation of 1 gram atom.

The explanation of these apparent difficulties constitutes one of the great theoretical syntheses of modern physics. According to Einstein's theory, mass and energy are equivalent, in the same sense that heat and work are equivalent. They are convertible into one another on a fixed scale, the energy equivalent of mass being given by the equation

$$E = c^2m,$$

where  $E$  is energy,  $m$  mass and  $c$  the velocity of light, or

$$1 \text{ gram} = 9 \times 10^{20} \text{ ergs,}$$

an enormous amount of energy, which may be brought home by pointing out that it is sufficient to give a million horse power for 33 hours. A million horse power is what America and Canada jointly draw from Niagara, so that the conversion of matter into energy at the rate of 1 gram every 33 hours (or, say, 1 ounce a month, roughly) would yield as much power as is drawn from the famous falls.

If we accept this equivalence of mass and energy, and there seems every reason to do so, then there is nothing astonishing in mass being apparently destroyed if a corresponding amount of energy is apparently created. Now 0.0183 gram is

## THE NEW CHEMISTRY

equivalent to  $0.0183 \times 9 \times 10^{20} = 1.64 \times 10^{19}$  ergs, so that we see where the energy comes from.<sup>1</sup> In atomic transmutations we do not have two laws, that energy is conserved and that mass is conserved, but one law, that energy + mass, the two being expressed in the same unit by Einstein's relation, is conserved.<sup>2</sup>

If, then, we could transmute matter in weighable quantities (let us remember that a million million million atoms of lithium make up about the

<sup>1</sup> Actually the mass taken for lithium 7 in the above example is a mass slightly corrected from the experimentally found one, the correction being worked out by assuming Einstein's relation to be true, so that the excellent agreement is, to a certain extent, deceptive. The Einstein relation has, however, been confirmed with great accuracy in other transmutations. The reason that the case of lithium, where the mass determination is not so exact as in certain other cases, has been here taken as an example is its great simplicity. It is, however, interesting to note from this that the transmutation measurements, together with the Einstein relation, give us the most accurate way of determining the atomic weight in the case of many light isotopes, the mass of certain fundamental units, such as the proton and the helium nucleus, being taken as known. These have been determined to a very high degree of accuracy by Aston, who gives (July 1936) the following values on the physical scale :

$$\begin{aligned} \text{H} &= 1.00812 \pm 0.00004 \\ \text{D} &= 2.01471 \pm 0.00007 \\ \text{He} &= 4.00391 \pm 0.00016 \\ \text{C} &= 12.0035 \pm 0.0003 \end{aligned}$$

<sup>2</sup> Of course, even in the chemical case, there must be a diminution of mass corresponding to the appearance of energy, but this change in mass is so excessively minute that there is no possible way of detecting it. If the masses involved in ordinary reactions could be measured with any fantastic degree of precision desired, we could adopt one law in the ordinary chemical case. As it is, the scales of mass and energy are so different that we are in practice inevitably led to adopt two laws when the energies involved per atom are small.

## THE NEW CHEMISTRY

least weight detectable on the most sensitive balance, and that the mass converted into energy is only a fraction of a per cent of the mass of lithium involved) we should have a source of very great energy. So far, however, the rates of transmutation effected are not even millions of atoms per minute, which would be little enough. We do not really know yet what are the conditions which govern the possibility of a transmutation : there is no satisfactory theoretical relation to give us the percentage of mass that can be transmuted per unit time under given conditions. Let us think again of the old chemistry. Here the first law of thermodynamics tells us the amount of work that is equivalent to a given amount of heat, but tells us nothing of the conditions under which transmutation of heat into work can be effected, nor of what fraction of the heat can be transmuted. The second law of thermodynamics determines these conditions. In the new chemistry Einstein's relation is the analogy of the first law, and gives us the amount of work that is equivalent to a given mass. So far we have no general second law to tell us under what general conditions the conversion of mass into energy can be effected, nor what percentage of the total mass present can be transmuted under given conditions.

## THE NEW CHEMISTRY

### *The Particles*

In all atomic reactions certain elementary particles are involved. In many cases we have to deal with ones that have been discovered only in the last few years, so that it may be well to give a list of all the particles which we shall have cause to mention.

*The Electron* is so familiar that we include it for the sake of completeness only. It is a particle of pure negative electricity. The magnitude of the charge in the electron is taken as that of unit charge in all atomic work, and will be so named here. The mass of the electron is very small, only about  $1/1850$  of that of the hydrogen atom.

*The Positron* is the recently discovered positive counterpart of the electron, a particle of pure positive electricity. Its mass is the same as that of an electron. Its charge is of equal magnitude but opposite sign. Its free life is exceedingly short, which is why it remained so long undiscovered. It is supposed to disappear by combining with an electron; energy, equivalent in amount to the mass which vanishes, being emitted as radiation.

*The Proton* is the nucleus of a hydrogen atom. Its mass is taken as the unit of mass, except for a

## THE NEW CHEMISTRY

small fractional part, the consideration of which would take us too far from our subject. We may say, in any case, that its mass number is 1, for the mass number is the whole number nearest to the mass of an atom, expressed in terms of the oxygen isotope  $^{16}\text{O}$  as 16. The actual mass differs in all cases only very slightly from the mass number. The charge on the proton is a positive charge of 1 unit.

*The Alpha Particle* is a helium nucleus. Its mass number is 4, and its charge a positive charge of 2 units.

*The Deuteron (or Diplon)* is the nucleus of the heavy isotope of hydrogen, which has the same nuclear charge as ordinary hydrogen, but twice the mass number. A deuteron has, therefore, a mass of 2 units, a positive charge of 1 unit. Swift deuterons have been very much used as an agent for provoking transmutations.

*The Neutron* is a recently discovered entity of unit mass, that is, of the mass of the proton, but having no charge. The ionisation produced by a moving particle is due to the interaction of its electric force with the electric field of the atom transversed, and the slowing down of the particle is due to the same effect. Since a neutron has practically no electric field it produces hardly any ionisa-

## THE NEW CHEMISTRY

tion, and it can pass through inches, if not feet, of lead. Owing to the absence of ionisation its passage cannot be detected electrically or by the Wilson chamber. A neutron can, however, strike a proton and communicate to it sufficient energy for its path to be detected by the methods to be described. One consequence of this is that neutrons are easily absorbed by paraffin wax, although they penetrate lead so easily. The protons, the hydrogen atoms in the paraffin wax, are struck by the neutrons, and at each such collision a proton acquires energy at the expense of the neutron. A much-used source of neutrons is a mixture of beryllium powder and radium emanation. An alpha particle from the emanation produces a neutron according to the reaction

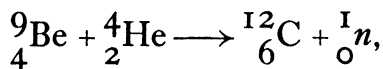

the symbol of the neutron being  ${}^1_0n$ , unit mass and no charge.

### *Apparatus of the New Chemistry*

We turn to the apparatus for producing nuclear reactions, and methods of detecting them, for in general these reactions are on a very small scale, a

## THE NEW CHEMISTRY

few tens or a few hundreds of atoms per second, which means that it would take a million years to produce a weighable mass of transmuted matter. We need, in fact, detecting apparatus that can deal with single atoms. Luckily, the essential products of the reactions move with a very high energy, so that they produce intense ionisation along their paths. This can be utilised in two ways. In the first place we can register effects due to the ionisation on an electrical instrument, so as to count the particles. We may, for instance, by the use of a powerful electric field, drive these primary ions so strongly that they produce secondary ions; the total ionisation is then sufficient to enable the electrical effect to be registered as a kick on a sensitive instrument. The passage of each particle is in this way recorded.

There are various types of apparatus for magnifying the primary ionisation: perhaps that most frequently used is the so-called Geiger-Müller counter, which consists of a metal cylinder carrying a fine insulated axial wire. The field is applied between cylinder and wire, and is very intense round the wire itself—sufficient, in fact, just to fail to produce a discharge in the absence of primary ionisation. Various details of the disposition ensure that the effect of ionisation shall be

## THE NEW CHEMISTRY

a momentary kick only. Another way of counting the particles is to use a small condenser, and by means of an electric field between the plates to drive the charge into one plate. This plate is connected to the grid of a special valve, and the change of potential consequent on the temporary charge is amplified by the usual valve technique. Plate I (Frontispiece) shows records made by an oscillograph connected to such an amplifier: (*a*) shows the counting of protons and (*b*) the counting of alpha particles. The black time signals at the top of each record are made every ten seconds, so that it is clear that rates up to a hundred a second can be counted by this method.

In the second place, we can photograph the tracks of swift electrified particles by the method of C. T. R. Wilson. Wilson showed that, when a sudden cooling of air saturated with water vapour took place, the moisture condensed on any ions that might be present, each ion acting as a centre of condensation. The cooling can be conveniently produced by the sudden expansion of air contained in a glass covered cylinder, the so-called Wilson cloud chamber. Under these conditions the ions formed along the path of a swift particle become each one the core of a tiny droplet, so that the path is revealed as a white line of close droplets, which

## THE NEW CHEMISTRY

can be photographed by suitable illumination. In this way not only the direction but also the length of the track, the so-called range, can be obtained. The method is an exceedingly powerful one, and the Wilson chamber is just as essential a part of the equipment of an atomic laboratory today as was an electrometer in the early days of electronic research.

The early transmutations were produced by alpha particles, which, in the case of Radium C, for instance, are shot off by the natural radioactive substance with an energy equivalent to that which would be produced, in the case of a singly-charged particle, by a field of 7.7 million volts. The trouble about the particles from naturally radioactive substances is their scarcity: although 1 milligram of radium gives off about 37 million particles, of homogeneous velocity, per second, which sounds a lot, actually only about 1 in a million particles produces a transmutation under favourable conditions, so that, from our point of view, the supply is feeble. The current corresponding to these numbers, that is, the charge carried per second, is only  $1.2 \times 10^{-11}$  amps. When the magnitude of the current in some of the modern devices for producing swift particles is considered—for instance, with the 2-million-volt apparatus of

## THE NEW CHEMISTRY

E. O. Lawrence; the current may be  $10^{-6}$  amps, while in the apparatus of Rutherford, Oliphant and Kinsey, designed for the much lower potential of 250,000 volts, it is  $10^{-3}$  amps—the relative feebleness, as far as quantity is concerned, of even the strongest source of radium, say 1 gram, is evident.

It was originally believed that energies approaching those of the natural alpha particles, which means voltages approaching 7 millions, would be necessary if particles accelerated in the laboratory were to produce nuclear transmutations. This belief for some time held up attempts to utilise such artificially accelerated particles as projectiles, since voltages of this magnitude, although now within sight, were out of the question, say, ten years ago. Recent theory, however, due to the independent work of Gamow and of Gurney and Condon, has shown that transmutation at comparatively low voltages is not impossible, but only relatively improbable, so that a very large number of particles at, say, 500,000 volts, will be as effective as a smaller number at 2 million volts, or a very much smaller number still at 4 million volts. This means that, although transmutations can be effected at relatively small voltages, efforts to realise higher and still higher voltages continue, for, with a given



PLATE II

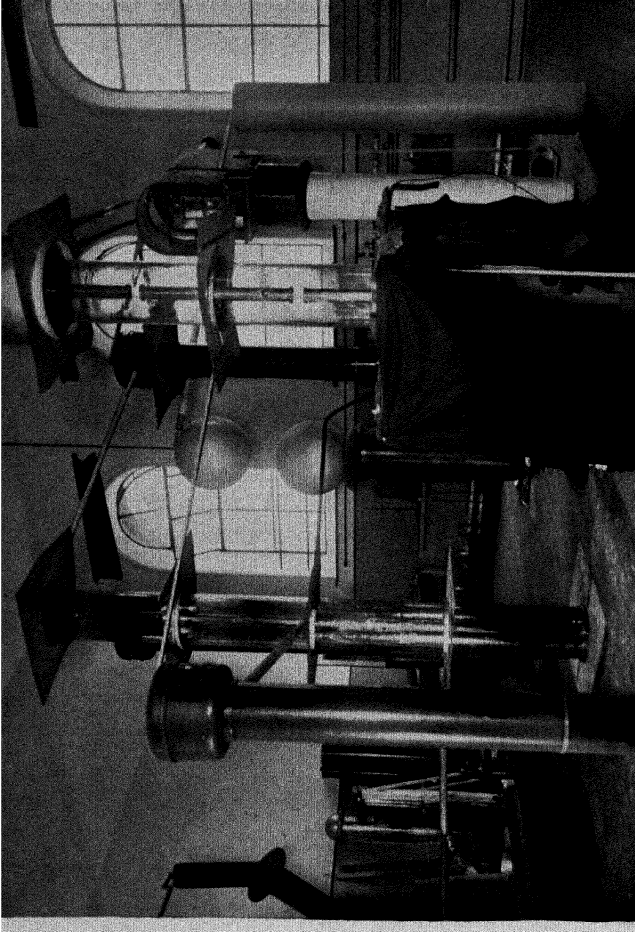

*Reproduced by courtesy of the Royal Society*

THE HIGH VOLTAGE APPARATUS OF DR. COCKCROFT AND WALTON,  
IN THE CAVENDISH LABORATORY AT CAMBRIDGE

## THE NEW CHEMISTRY

number of particles, the efficiency of the apparatus rises very rapidly as the voltage increases.

A high voltage apparatus may be regarded as a gun in which the projectiles, which are usually protons or deuterons, can be accelerated, and so

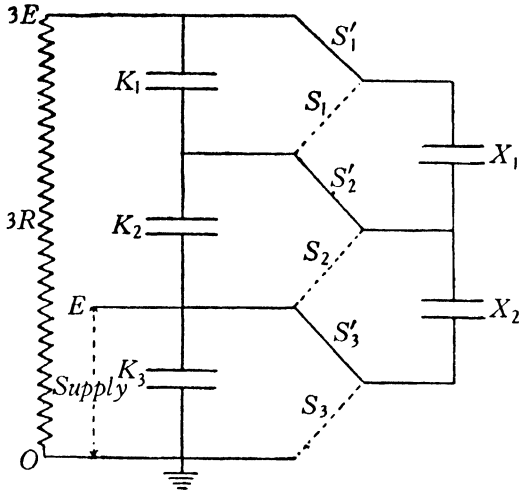

*By courtesy of the Royal Society*

FIG. 1

THE PRINCIPLE OF COCKROFT AND WALTON'S HIGH  
VOLTAGE APPARATUS

endowed with sufficient energy to produce transmutation in favourable circumstances. We now turn to the devices by which high voltages are reached today.

The apparatus used in Cambridge, with which the first results in artificial transmutations were obtained by Cockcroft and Walton, makes use of the principle illustrated in Fig. 1.  $K_1, K_2, K_3$  and

## THE NEW CHEMISTRY

$X_1$ ,  $X_2$  are condensers, which can be connected in quick succession either along the broken lines  $S_1$ ,  $S_2$ ,  $S_3$  or along the full lines  $S'_1$ ,  $S'_2$ ,  $S'_3$ . The actual switching over from one method of connection to the other is effected by hot filament valves of special construction. The method of operation can be easily followed if we consider the history of the charge on the condenser  $K_3$ , which is maintained at a constant potential of some hundred thousand volts by a high-tension transformer. When the connection is made along the broken lines, this condenser shares its charge with  $X_2$ , which, when the method of connection is changed, shares its charge with  $K_2$ , and so on, as the connection alternates, until  $K_1$  has part of the original charge. By a rapid series of alternations the charges on  $K_2$  and  $K_1$  are thus built up until the potential difference between the high side of  $K_1$  and the low side of  $K_3$  is three times or so the supply potential. The actual apparatus is illustrated in Plate II.

E. O. Lawrence and M. S. Livingstone, in the University of California, have perfected a most ingenious apparatus which they call a cyclotron. Of this Lawrence states (September 1935): "Thus far we have accelerated deuterons to energies only slightly above five million, and the most energetic

## THE NEW CHEMISTRY

deuterons we have actually used in nuclear investigations had energies of about 4.5 million volts. The time, of course, will come when we will want to go up to higher voltages, and from our recent experience we are confident that, by using the full

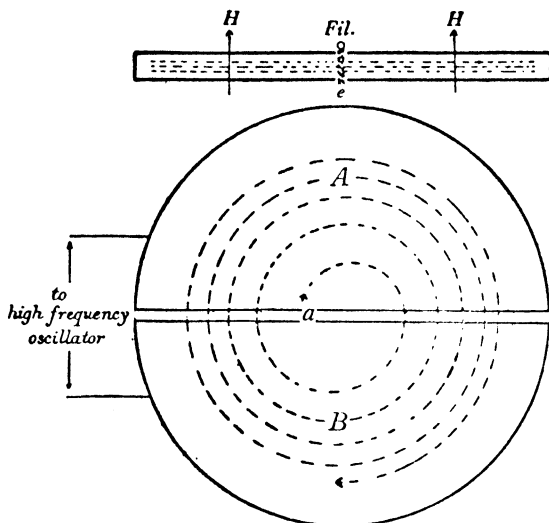

*By courtesy of the Physical Review*

FIG. 2 A

### THE PRINCIPLE OF THE CYCLOTRON

power of the magnet, we will be able to produce deuterons of energies above ten million volts, and possibly above fifteen million volts." The principle is illustrated in Fig. 2 A. A and B are two flat semicircular boxes, insulated from one another. Between these an alternating potential difference of some thousands of volts (say ten thousand) is maintained by a water-cooled power tube oscillator. At

## THE NEW CHEMISTRY

the centre is a source of ions—protons or deuterons—produced by a stream of electrons, which ionises the residual gas. The whole is placed between the poles of a huge electromagnet, weighing about 85 tons, which is the weight of a fair-sized locomotive.

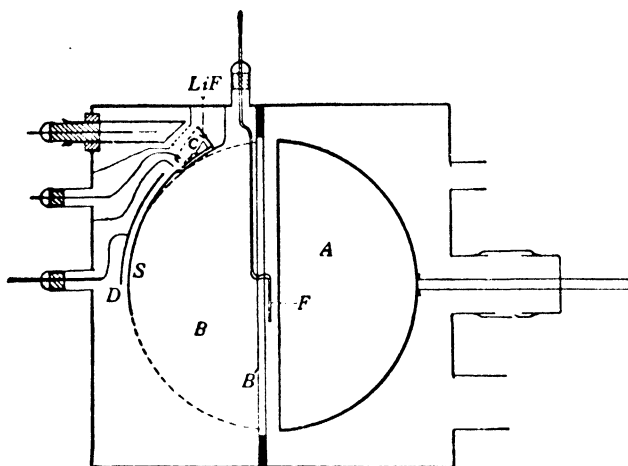

*By courtesy of the Physical Review*

FIG. 2 B

### THE PRINCIPLE OF THE CYCLOTRON

The size of the pole pieces of the magnet can be gathered from Plate III, which shows the apparatus in position: the large flat cylinders, which constitute the chief feature of the picture, are, of course, the windings. Owing to the magnetic field the ions move in circular paths. When an ion passes from one box to the other, say A to B (Fig. 2 A) it suffers an acceleration corresponding to the potential difference, and the frequency of the alter-

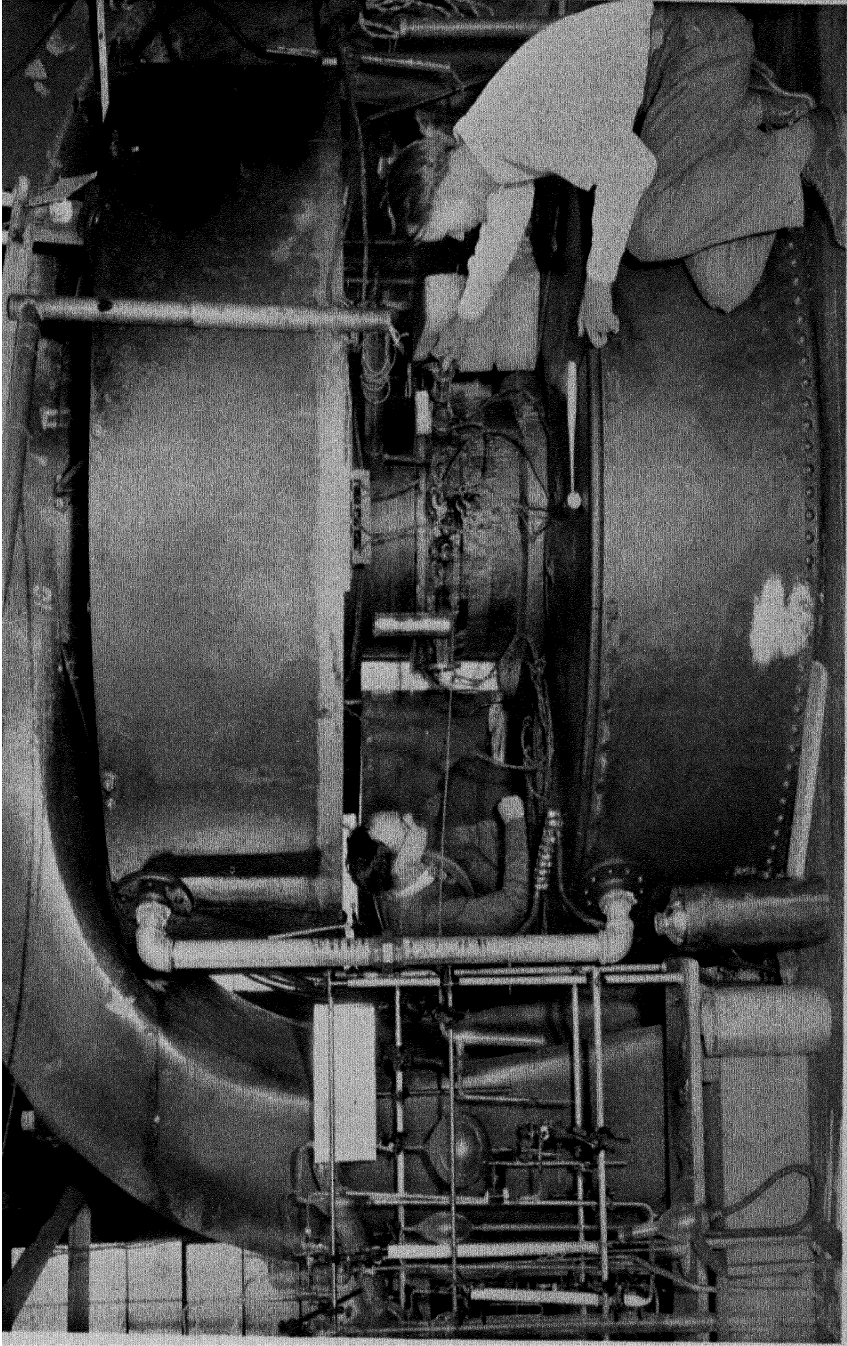

*Reproduced by courtesy of Professor E. O. Lawrence*

THE CYCLOTRON, SHOWING THE LARGE MAGNET. ON THE LEFT IS DR. R. L. THORNTON,  
ON THE RIGHT DR. EDWIN McMILLAN



## THE NEW CHEMISTRY

nating field is so arranged that as the ions issue from the one box to the other on their return, that is, from B to A, they are once more accelerated, the potential having just changed sign. At every half revolution, therefore, the ions acquire additional energy of motion, so that the effective potential difference can be indefinitely multiplied. The faster the ions are moving, the bigger the radius of their circular path, but the time to describe a half revolution luckily remains the same, the added speed compensating for the larger path. The ions therefore describe a spiral path, as shown in Fig. 2 A, and ultimately issue from the edge of the box with an energy corresponding to, say, several hundred times the applied potential. Fig. 2 B shows the arrangement in a little more detail, the target to be bombarded being placed at C. The filament for producing the ionising electrons is shown at F, while D is a deflecting electrode which suitably modifies the final path of the ions. Plate IV shows the actual apparatus, seen in position between the poles of the magnet in Plate III. In Plate V is seen a beam of  $5\frac{1}{2}$  million volt deuterons, which conveys charge at the rate of 5 microamperes, emerging from a cyclotron into free air. It traverses a distance of 10 inches, rendering the air brightly luminous in its path.

## THE NEW CHEMISTRY

A third manner of producing high potentials, based on quite a different principle, has been developed in America, by Dr. Van de Graaff and his collaborators. The principle is exceedingly simple : charges are sprayed onto a moving belt, of insulating

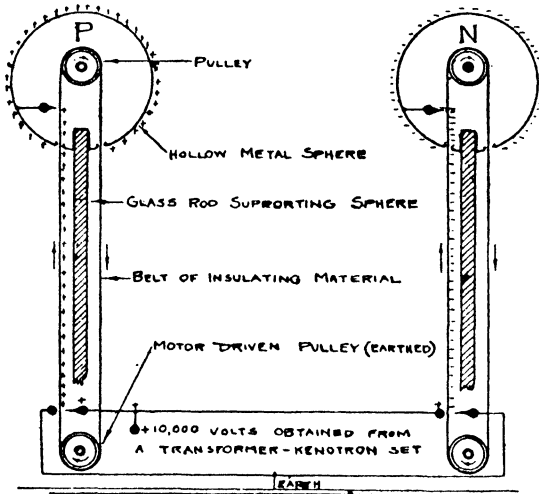

*By courtesy of the Physical Review*

FIG. 3

### THE PRINCIPLE OF THE NEW ELECTROSTATIC GENERATOR

material, and carried by the mechanical motion to the interior of a very large hollow metal sphere, where they are given up. The underlying thought is very much like that of the old influence machine, with a moving disc, or discs, of insulating material. Fig. 3 illustrates the general scheme of a simple generator of this type. The two spheres, P and N,

PLATE V

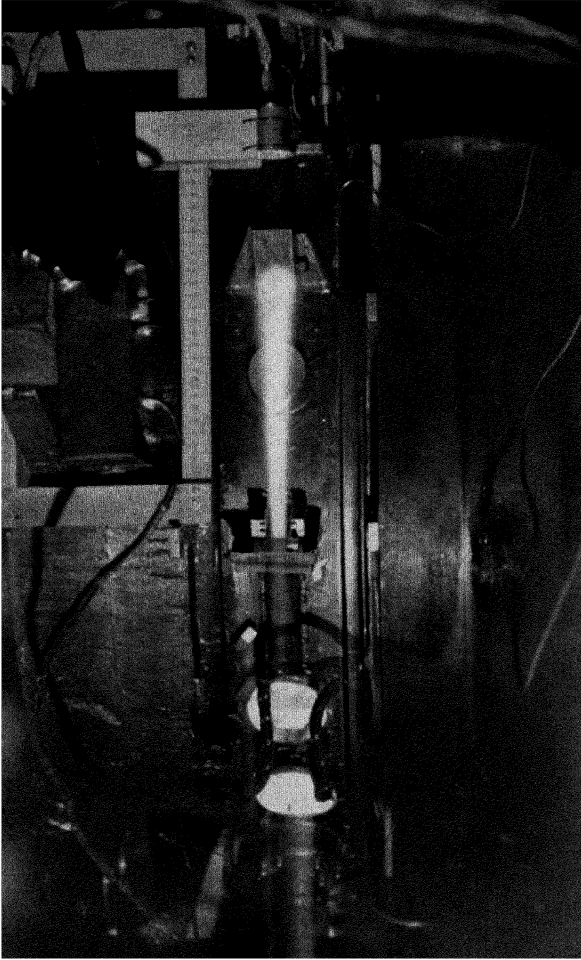

*Reproduced by courtesy of Professor E. O. Lawrence*  
A BEAM OF 5½ MILLION VOLT DEUTERONS, OF STRENGTH 5 MICROAMPERES, :  
SHOOTING OUT INTO AIR FOR A DISTANCE OF 25 CM.



## THE NEW CHEMISTRY

are charged positively and negatively by the endless bands, which may be of silk or paper. The charges are sprayed onto these by a brush discharge from the points shown, each opposite to a small sphere, at the bottom of the belts, the high potential being connected to one point and one ball, so that the

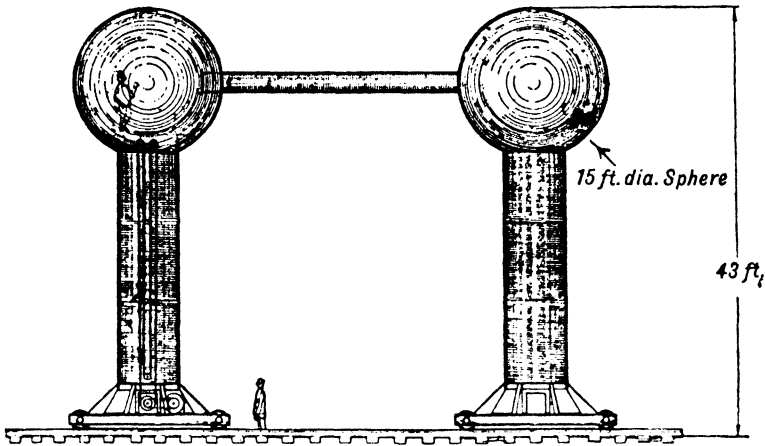

*By courtesy of the Physical Review*

FIG. 4

THE ELECTROSTATIC GENERATOR BUILT AT THE MASSACHUSETTS  
INSTITUTE OF TECHNOLOGY

(The men are depicted to give the scale)

signs are positive and negative. Plate VI shows one terminal of a generator built on this principle at the Carnegie Institution, Washington, attached to a special type of tube, of the so-called cascade pattern, designed to stand potentials of a million volts or so. A very much larger outfit has been constructed by Van de Graaff and his colleagues at

## THE NEW CHEMISTRY

the Massachusetts Institute of Technology, the size of which may be judged from Fig. 4. It has been announced that potentials of some seven million volts have been obtained, but details are lacking. In any case, there will be the greatest difficulty in constructing a tube to stand anything like this voltage. With the cyclotron the tube difficulty does not arise.

### *Transmutations*

With any of the high voltage apparatus described, projectiles may be fired with very high energies. So far the only particles that have been extensively used for bombardment are the proton and the deuteron, the latter having proved particularly productive of interesting results. According to the theory of Oppenheimer and Phillips, this arises because the deuteron consists of a proton and a neutron bound together, and the neutron, having no charge, can penetrate without opposition the very strong electric field that opposes the entrance of charged particles within the nucleus. The theory, of course, involves a consideration of the finite size of the deuteron, in terms of the theory of wave mechanics. Roughly speaking, then, the proton

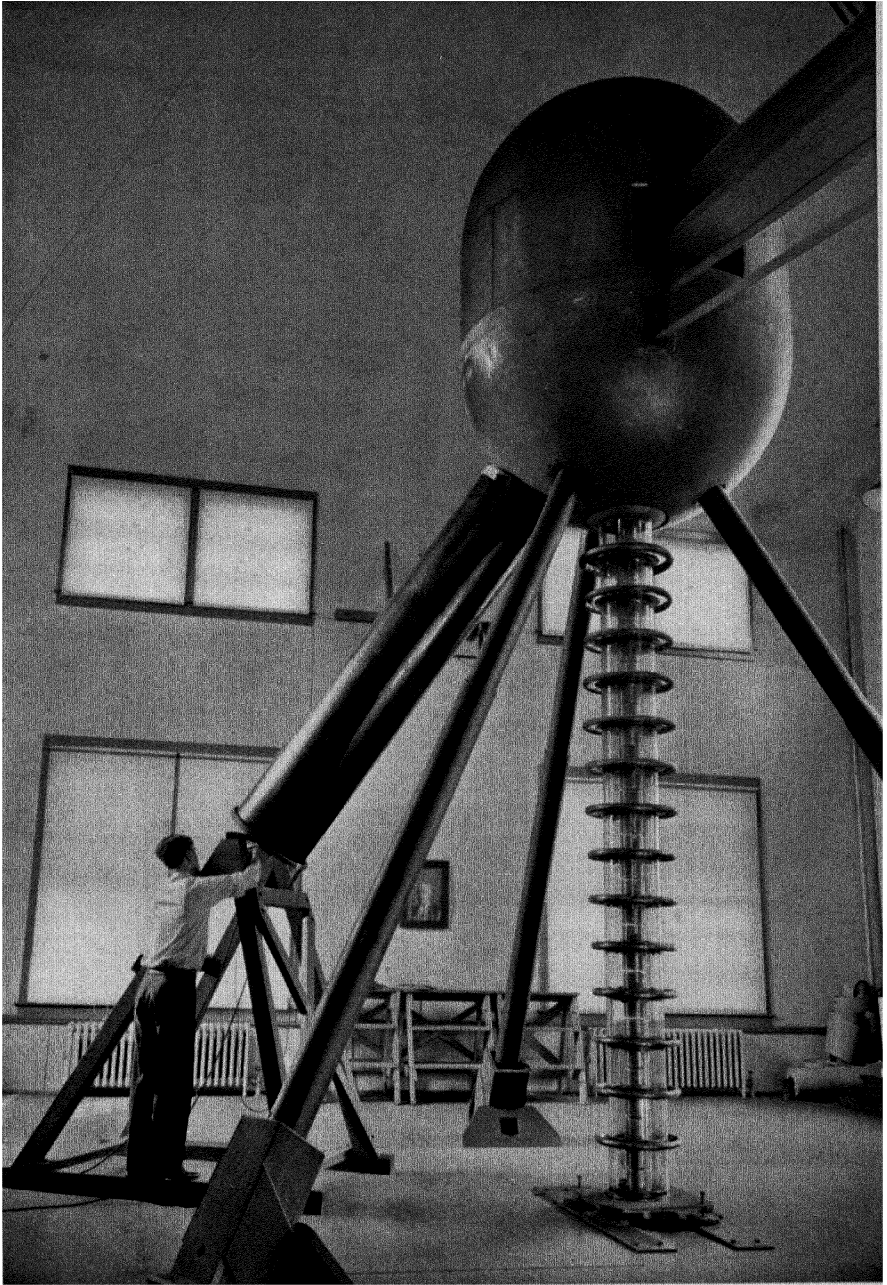

*Reproduced by courtesy of the Carnegie Institution, Washington*

THE ELECTROSTATIC GENERATOR AT THE CARNEGIE INSTITUTE, WASHINGTON,  
WITH A CASCADE TUBE IN POSITION



## THE NEW CHEMISTRY

part, having a charge, enables us to catch hold of the deuteron with our electric force, and communicate a high energy to it, while the neutron part, having no charge, effects the penetration on arriving.

A very large number of transmutations have now been effected and studied in detail, mainly by Rutherford and his school at Cambridge, and the Californian School of E. O. Lawrence, Livingstone and others. Many of them are concerned with the simple elements lithium, beryllium and boron, whose atomic numbers are 3, 4 and 5 respectively. It must be remembered that normally lithium consists of two isotopes, of mass numbers 6 and 7 : beryllium of isotopes 8 and 9 : and boron of isotopes 10 and 11, which complicates matters, since which isotope is involved in a reaction can only be deduced from a study of the tracks when the normal metal is bombarded. We say the normal metal, because experiments are now being made on isolated isotopes : for instance, in the Cavendish Laboratory sufficient quantities—about a thousandth of a milligram—of the two isotopes of lithium have been obtained separately for the reactions of each to be studied alone.

We will take a few examples of artificial transmutation produced by swift protons. With the 7 isotope of lithium two helium nuclei, or alpha

## THE NEW CHEMISTRY

particles, are produced, according to the formula

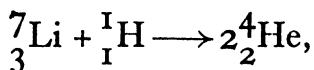

the range of the alpha particles agreeing well with that calculated from the change of mass, expressed as energy by the Einstein relation. The reaction, as photographed by the aid of the Wilson chamber, is shown in Plate VII, which is due to Dee and Walton. The four bundles of tracks are due to the fact that the alpha particles issue into the chamber through a four-sided cage, with windows of very thin mica, and the fact that the range is less for one bundle than for the other is due to a difference in thickness of the mica windows. But this is not the only possibility. Crane and Lauritsen have shown that it is possible to form beryllium according to the formula

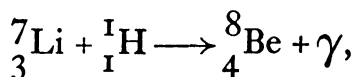

the surplus mass appearing as energy in the form of a gamma ray, as indicated. Dee and Walton have also established a transformation with the other isotope of lithium,

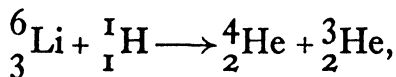

which shows the formation of an isotope of helium,

PLATE VII

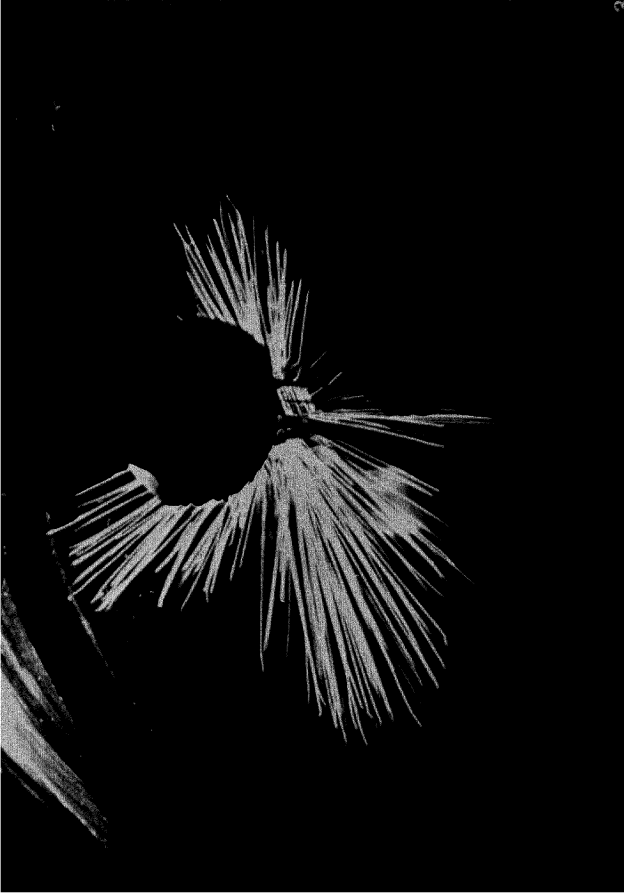

*Reproduced by courtesy of the Royal Society*

THE TRANSMUTATION OF LITHIUM INTO HELIUM BY PROTON BOMBARDMENT,  
PHOTOGRAPHED IN THE WILSON CHAMBER BY DRS. DEE AND WALTON



## THE NEW CHEMISTRY

${}^3_2\text{He}$ , that has only been detected in these nuclear transformations, and not in the ordinary helium gas. An extraordinary transformation is that produced by protons with boron, for here three alpha particles can arise

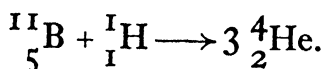

Here, as in all these formulae, the upper affixes must add up to be equal on both sides ( $11 + 1 = 3 \times 4$ ) and the lower affixes must do the same ( $5 + 1 = 3 \times 2$ ) Plate VIII, due to Dee and Gilbert, illustrates this transformation. The particles marked A and B are emitted in nearly opposite directions, so that the third, C, receives little energy, and gives a short track.

As already stated, deuterons have proved very effective in producing nuclear transformations. One of the most interesting reactions is produced by bombarding deuterium (heavy hydrogen) with deuterons, which results in the disintegration of the deuteron. This was first established by Oliphant, Harteck and Rutherford, the reaction being

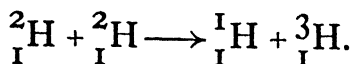

This formula has been confirmed by Dee, who has measured the tracks and checked up the energy-mass relation. The existence of a new isotope of

## THE NEW CHEMISTRY

hydrogen  ${}^3_1\text{H}$ , weighing three times as much as the ordinary atom of hydrogen, is therefore definitely proved. The new helium isotope has also been obtained from the same reacting nuclei, a neutron being emitted.

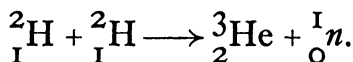

Many other transmutations have been produced by deuterons, as, for instance

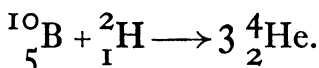

The reactions so far cited are all of one type, the so-called capture disintegration, the process being most easily considered as consisting of the close collision, or fusion, of the two nuclei, in general followed immediately by a redistribution of the component parts as fresh nuclei, manufactured from the old. There is a simpler type of capture disintegration, in which the fusion takes place without any subsequent redistribution, as exemplified by the reaction

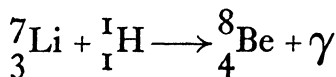

already quoted. The emission of the gamma ray is due to the fact that the beryllium nucleus is formed in an excited state: the energy released when the nucleus returns to the ground state appears as a gamma ray.

PLATE VIII

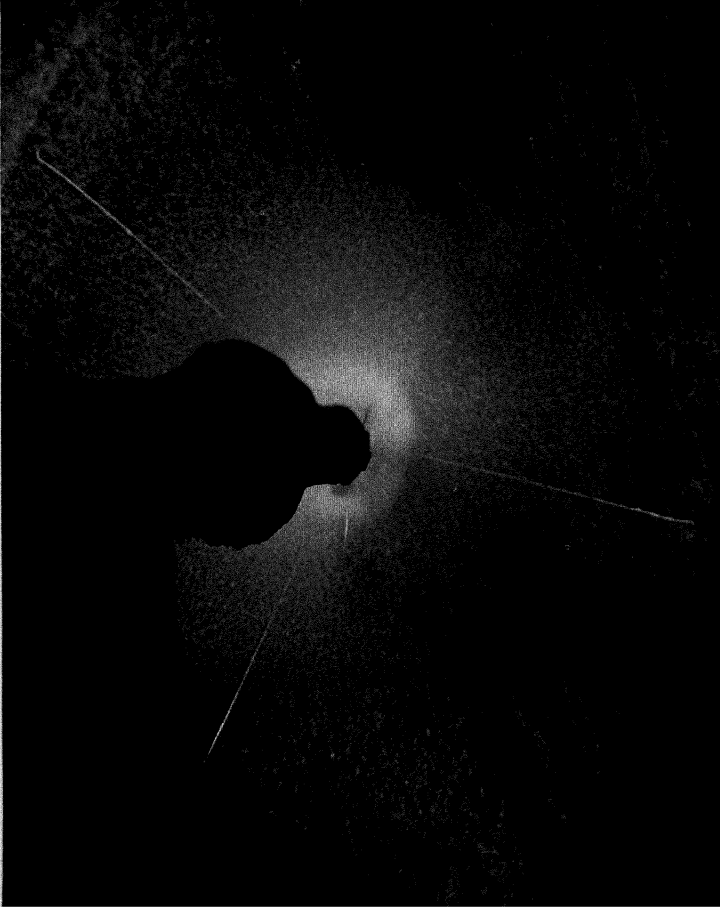

*Reproduced by courtesy of the Royal Society*

THE TRANSMUTATION OF BORON INTO HELIUM BY PROTON BOMBARDMENT,  
PHOTOGRAPHED IN THE WILSON CHAMBER BY DRS. DEE AND GILBERT



## THE NEW CHEMISTRY

There is some evidence that non-capture disintegrations can take place in certain cases : in this type the bombarding particle maintains its individuality, but part of its energy is used to disrupt the struck nucleus. The case best attested seems to be that of the bombardment of deuterium by fast alpha particles, where the reaction accords with the following equation

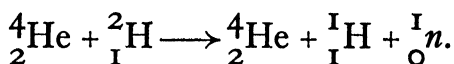

The disintegrations here discussed are those which have been produced by artificially accelerated particles. It must not be forgotten that a number of transmutations have been produced by natural alpha particles, and, in fact, that all the early effects were obtained in this way. Typical are the pioneer experiments of Rutherford, in which he demonstrated the expulsion of a proton from the nitrogen nucleus, and so first established the transmutation of a non-radioactive atom. In general, however, these reactions with natural alpha particles have been studied in less detail, and are, moreover, fully described in the standard books.

We may say that not only have atomic transmutations been produced by protons and deuterons, accelerated in strong electric fields, but that the agreement with theory is excellent, both as regards

## THE NEW CHEMISTRY

the Einstein relation, and also in respect of the prediction of the very rapid increase of efficiency of transmutation with rising voltage. New isotopes have been discovered, notably the isotopes of hydrogen and helium of mass-number 3,  ${}^3_1\text{H}$  and  ${}^3_2\text{He}$ , and the atomic weights of certain species of atom have been very accurately found, by applying the Einstein relation to reactions in which all of the weights except one are known to a high degree of precision. The new chemistry is established on a sound basis.

### *Artificial Radioactivity*

Radioactivity until two years or so ago was exclusively a property of certain of the heaviest elements, which spontaneously broke down with the emission of a charged particle—electron or alpha particle—and became new elements. All the known radioactive elements were the result of radioactive charges proceeding from one of the two parent substances, uranium or thorium, which were continually radiating and producing each a new element; these in their turn emitted radiations and produced new elements, the chain of products end-

## THE NEW CHEMISTRY

ing in the stable element lead. The periods of transformation of uranium and thorium are extraordinarily long, the half life being of the order of ten thousand million years, to which fact we owe the presence of radioactive elements in nature. If radium, for instance, were not continually being grown by uranium, there would not be any left today, for in the course of geological time any present at the beginning would have practically disappeared.

One of the things that were formerly held to be most certain about radioactivity was that we could by no means influence radioactive breakdown; that we could neither accelerate nor retard the rate of decay of a given element, and still less produce a radioactive atom. Radioactive changes are nuclear changes, and none of our ordinary laboratory experiments touch the nucleus. Radioactive atoms are, in fact, those for which the nucleus is inherently unstable : whereas the nucleus of a lead atom is a structure which can, apparently, remain unchanged indefinitely, the nucleus of a radium atom is a metastable collection of particles which may, at any moment, slip over into some new disposition, the rearrangement being accompanied by the emission of a particle, and the formation of a new atom.

It was believed, then, that certain heavy, and

## THE NEW CHEMISTRY

therefore complicated, nuclei were radioactive by nature, and that the hindering or conferring of radioactive properties was a matter outside laboratory control. In 1934, however, I. Curie and F. Joliot were conducting experiments in which they bombarded elements with alpha particles from polonium, a radioactive element used because it does not give out gamma rays, which have a disturbing influence in this type of experiment. They found that positrons were emitted by aluminium while it was being bombarded, and, further, that the emission continued after the source of alpha particles had been removed from the neighbourhood. The radiation diminished exponentially with time, like that of a natural radioactive substance, the half period being about 195 seconds. In other words, some of the aluminium atoms had, owing to bombardment, become endowed with the property of radioactivity. Actually what happens is that from the aluminium nucleus a new nucleus, a hitherto unknown isotope of phosphorus, is formed ; this isotope is unstable, and breaks down with the emission of a proton. The formation of the phosphorus isotope is accompanied by the emission of a neutron, thus

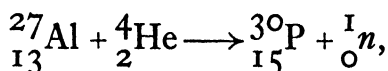

## THE NEW CHEMISTRY

while the isotope breaks down according to the equation

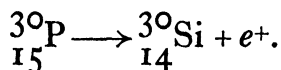

The way in which the chemical nature of the artificially formed radioactive element, in this case phosphorus, can be confirmed is very simple. The irradiated element, pure aluminium, is dissolved, and a small amount of the element whose formation is suspected, here phosphorus, is added to the solution, generally in the form of a soluble compound. The added element is then precipitated and removed. If a substance isotopic with it has been formed by the irradiation, it will, of course, be removed as well, since all isotopes behave in the same way chemically, and the radioactivity will thus be separated from the solution. The precipitate can easily be tested for radioactivity by one of the special methods already described. In the case considered it was found that the activity was removed with the phosphorus, and so the scheme shown in the equation was verified.

Similarly, a radioactive silicon isotope has been made from magnesium,

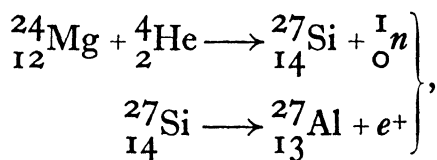

## THE NEW CHEMISTRY

and there are two other isotopes of magnesium which undergo activation, of which we may take the following as typical,

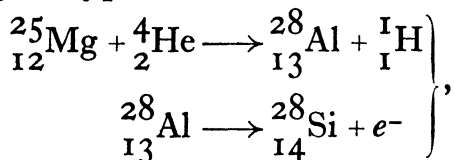

a negative electron being emitted. Another typical reaction is that of boron,

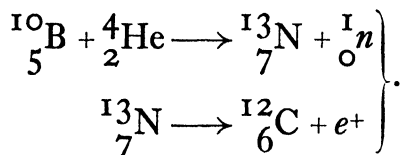

The chemical test in this case was carried out by irradiating boron nitride, which was then decomposed, by the addition of sodium hydrate, into ammonia and boric acid. Any isotope of nitrogen must go, of course, into the ammonia. It was found that the residue was inactive, but that the ammonia showed the full activity to be expected, so that the attribution was confirmed.

It may be mentioned that the reaction leading to radiophosphorus is not the only one that may take place. Alternatively, a stable isotope of silicon may be formed, with emission of a proton, according to the equation

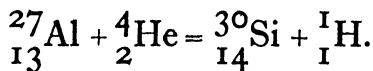

## THE NEW CHEMISTRY

Ellis and Henderson have shown, in fact, that this is the more probable reaction, the process that leads to neutron emission occurring relatively seldom.

Sometimes there is formed by bombardment a radioactive element which is isotopic with its parent, as happens, for instance, in the case of iodine. When this occurs ordinary chemical methods of separation fail. Szilard and Chalmers, however, have taken advantage of the fact that any atom which is activated by the impact of an alpha particle will be dislodged by that impact from any molecule of which it forms a component part. Thus, starting with ethyl iodide, any atoms that are transformed will exist after activation as free iodine. In accordance with the method described earlier, free iodine can be added, and then removed, when any activated iodine atoms will be removed with it, the unactivated iodine remaining in combination.

Naturally, attempts were at once made to investigate artificial radioactivity by using accelerated protons and deuterons in place of natural alpha particles. A large number of new atoms which are unstable have been produced in this way. With protons, for instance, incident on carbon, a new isotope of nitrogen,  ${}^7_{13}\text{N}$ , has been formed, which breaks down with emission of a positron,

## THE NEW CHEMISTRY

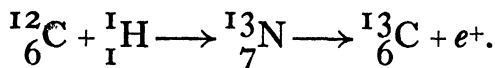

With deuterons we may take as an example boron, the reaction being, again according to Cockcroft, Gilbert and Walton

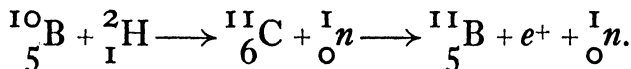

Very many radioactive elements have been produced by Fermi's method of neutron bombardment, referred to in the next section, all of these breaking down with the emission of a negative electron.

The most sensational manufacture of an artificially radioactive element has been carried out at California by Professor E. O. Lawrence. He has used a potential of two million volts or so, obtained with his cyclotron, to accelerate deuterons, in such quantity that the current conveyed by the rushing atoms is equivalent to a microampere,<sup>1</sup> and has exposed sodium to this bombardment. In this way a radioactive isotope of sodium, of mass number 24, is formed, according to the equation

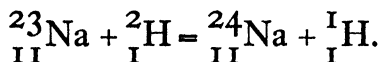

The active sodium reverts to magnesium,  ${}^{24}_{12}\text{Mg}$ ,

<sup>1</sup> This means about  $6.3 \times 10^{12}$  deuterons per second.

## THE NEW CHEMISTRY

giving out an electron in the process, and also a gamma ray, in accordance with the equation

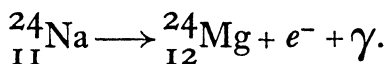

In Lawrence's experiments radiosodium was made in sufficient quantities to give out more than ten million electrons—or beta particles, as they are generally called when shot out at high speed by radioactive substances—per second. Since the yield of transmutations goes up very rapidly with voltage, it would appear, according to Lawrence, quite possible to obtain shortly a radiosodium source a hundred times as strong as this, *i.e.* giving a thousand million electrons per second. The number of atoms breaking down in one second in one gram of radium is 34 thousand millions, so that the manufacture of artificially radioactive elements in such quantities that the activity will equal that of the natural radium sources is certainly in sight.

This does not mean that the weight of radiosodium approaches the weight of the ordinary radium source. The rate of decay of radiosodium is very rapid (half life 15 hours) compared to that of radium (half life about 2000 years); the activity of a sample of radiosodium during its brief life is therefore about a million times that of the same number of atoms of radium. In the same way a

## THE NEW CHEMISTRY

fraction of an ounce of magnesium flash powder produces a brighter light, while it lasts, than a ton of coal burning slowly—the process is accomplished so quickly in the former case.

It is possible that radiosodium may have great medical uses, for it would seem to have many advantages. The rapid decay means great activity for a very small weight, and, further, that at the end of a week the activity will have practically disappeared. The element into which radiosodium changes is magnesium, which is quite harmless. There is therefore no need to remove the radioactive substance : for all practical purposes it removes itself. It can be introduced into the tissues of the body anywhere that may be required. If, therefore, intense local beta ray activity is a curative agent, radiosodium would seem to have an important future. A disadvantage is that, owing to the rapid decay, it must be freshly prepared.

### *The Neutron as a Transmuting Agent*

It was the Italian physicist, Fermi, who first saw that the neutron was a most promising agent for effecting transmutations, for, owing to its lack of charge, it can penetrate the electrical barrier of

## THE NEW CHEMISTRY

the nucleus with but little opposition. Neutrons are particularly effective against heavy atoms, where the highly charged nucleus is proof against the ordinary bombardment. Fermi and his collaborators, and another band of collaborators in Columbia—Dunning, Pegram, Fink and Mitchell—have between them effected a very large number of transmutations with neutrons, of which the following may be cited as an example: ·

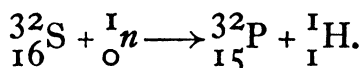

The  ${}_{15}^{32}\text{P}$  is radioactive, transforming with emission of an electron into the stable sulphur isotope  ${}_{16}^{32}\text{S}$ .

Fermi has even succeeded in making a new radioactive element, heavier and of greater atomic number than any hitherto known, by subjecting the heaviest of the ordinary elements, uranium, to neutron bombardment, in accordance with the equation

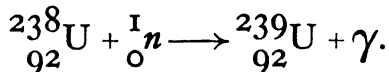

A new isotope of uranium is formed, which, in its turn, produces the new element 93 by discharging an electron

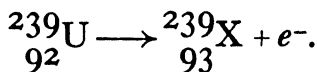

A large number of other artificially radioactive ele-

## THE NEW CHEMISTRY

ments have been made by neutron bombardment, so that practically all the way up the periodic table we now know of unstable nuclei which can be artificially made. They are all close neighbours of stable nuclei.

The original source of neutrons was beryllium exposed to the alpha rays from a radioactive substance,

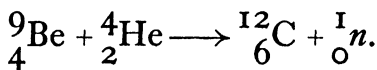

The Columbia workers have made very powerful neutron sources, by using very large quantities of radium emanation. However, here again the artificial swift particles, by the quantity in which they can be produced, seem to be likely to replace the natural alpha rays. In California the cyclotron has been used to bombard beryllium with two million volt deuterons, and a very powerful emission of neutrons has thus been produced.

### *Some General Problems of the New Chemistry*

The two characteristic numbers of a nucleus are its mass number  $A$  and its net positive charge  $Z$ , the former being generally at least twice as great as the latter.<sup>1</sup> It was formerly held that the mass

<sup>1</sup> Exceptions are  ${}^3_2\text{He}$  and  ${}^{11}_6\text{C}$ .

## THE NEW CHEMISTRY

was entirely due to  $A$  protons in the nucleus, the charge being less because of the presence of  $N = A - Z$  electrons,

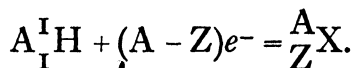

For theoretical reasons, which must not detain us here, it is now believed that there are no electrons in the nucleus, which is held to consist of  $Z$  protons and  $A - Z$  neutrons, so that

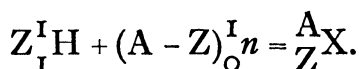

As far as the numerical equation is concerned,  $Z$  and  $A$  might have any values, or we might find any charge associated with any mass. Experiment shows, however, that a certain nuclear charge is associated with a comparatively small range of mass, and that the extremes of this range in general represent unstable (artificially radioactive) atoms. This is, perhaps, best exhibited by plotting the atomic charge, or number of protons,  $Z$ , against the number of neutrons  $A - Z$ . Fig. 5 exhibits such a plot for some of the lighter atoms, the stable atoms being represented by black discs, and the unstable by open circles. It will be seen that combinations which are stable, and occur in nature, lie in the neighbourhood of a line through the origin making  $45^{\circ}$  with the axes, and that the inner members of

## THE NEW CHEMISTRY

the group are stable, the border members unstable. There is, as it were, a valley of stability running across the diagram, and the members on the edge of the valley are liable to fall into it. Combinations well away from the valley are impossible.

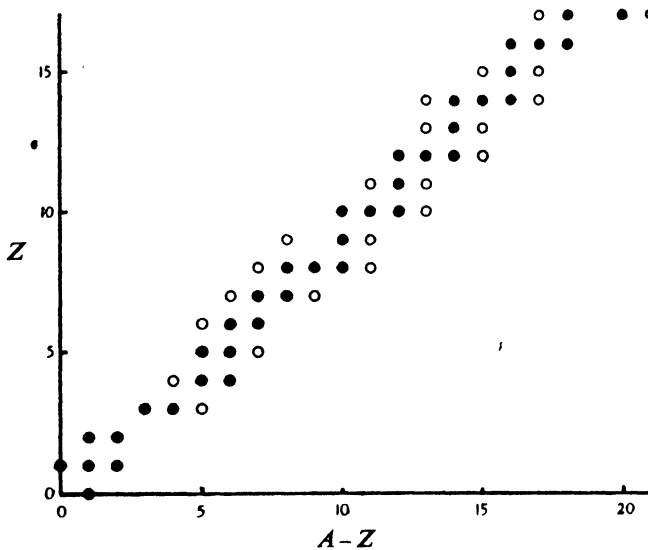

FIG. 5

One of the great problems of the new chemistry is to find convincing reasons for this. In other words, what are the rules which will enable us to predict which combinations of protons and neutrons are stable, which unstable, and which impossible? So far they have not been discovered. An extension of this problem would be to find how to predict the half-life period of the unstable nuclei.

Another problem, closely connected with that

## THE NEW CHEMISTRY

first discussed, is to find out what are the conditions which allow transmutation to take place, and, when the reaction between impinging particle and struck nucleus may take different forms, as in the proton-lithium encounter, to decide the relative possibility of the different transmutations.

### *Conclusion*

In these few pages we have been able to glance at only a few of the transformations effected in the new chemistry, just as in an elementary primer of the old chemistry only a few typical reactions are considered. Of the many theoretical treatments of the nucleus, based mainly on the new quantum principles of wave mechanics, we have said nothing. They are designed to elucidate such phenomena as the rapid increase of efficiency of transmutation with voltage, the effectiveness of the deuteron, and the variation of neutron transmutations with the energy of the neutron. They are not suitable for a short and simple exposition, and the general run of the experimental results can be followed without them.

In the equations here set down we have nuclei combining instead of atoms. In ordinary chem-

## THE NEW CHEMISTRY

istry we have often to apply heat to effect our reactions, the temperatures attained in our laboratory furnaces running up to about  $3000^{\circ}\text{C}$ . To this corresponds a certain amount of added energy of motion per atom, and for different reactions different energies are needed. Now what we do in our electrical guns is to give the reacting atoms a great energy of motion; in other words, we produce the same effect as a very high temperature would. What temperature would we need to produce for every atom to have the energy we get when working with a million volts? It comes out to about 7000 million degrees. Every flying atom which provokes a nuclear reaction has an energy corresponding to a temperature of this order. Such temperatures are, of course, unthinkable on earth, but temperatures of hundreds of millions degrees are supposed to exist in the interior of dense stars. Even here, however, the energy is not sufficient to produce nuclear transformation. We may say, then, that the modern electrical accelerator, as exemplified by the cyclotron and the Cavendish tubes, takes in nuclear chemistry the place of the furnace in the old chemistry, and that, in a sense, it produces locally temperatures greatly in excess of any which we suspect even in stars.

If we could make light atomic nuclei combine

## THE NEW CHEMISTRY

in quantity, we should have a systematic conversion of mass into energy which would seem to be promising from the industrial point of view. The combustion of the new chemistry—if we may so call the combination of nuclei with evolution of energy—is so effective that the complete combination of, for instance, 1 gram of lithium with hydrogen to form helium liberates as much heat (in the form of kinetic energy of alpha particles) as the combustion of ten million times the weight—that is, ten tons—of coal. The trouble is that, at present, in order to produce particles which will effect the combination of nuclei, we have to dissipate amounts of energy so large that the balance is enormously against us. We have to fire enormous numbers of atoms at random, to achieve an occasional effective hit, and all the atoms that do not effect a combination represent lost energy. In ordinary thermodynamics we know that we must have a large difference of temperature in order to convert heat profitably into work, and we know the exact conditions for the conversion of a given fraction of the heat. In the new chemistry we are, so far, without any precise knowledge of the conditions necessary for wholesale conversion. It may be that we shall never be able to utilise atomic energy, that is, mass energy, but even if

## THE NEW CHEMISTRY

this is so we may take comfort from the fact that it is certain that the atomic heat engine would be speedily followed by the atomic bomb. The pursuit of the new chemistry is none the less desirable if it does not seem possible so far to turn it to destructive ends.













