

UNIVERSAL
LIBRARY

OU_174120

UNIVERSAL
LIBRARY

ENGINEERING GEOLOGY

BY

H. RIES, PH.D.

PROFESSOR OF GEOLOGY IN CORNELL UNIVERSITY

AND

THOMAS L. WATSON, PH.D.

LATE PROFESSOR OF GEOLOGY IN THE UNIVERSITY OF VIRGINIA
AND STATE GEOLOGIST OF VIRGINIA

FOURTH EDITION

NEW YORK

JOHN WILEY & SONS, INC.

LONDON: CHAPMAN & HALL, LIMITED

1931

COPYRIGHT, 1914, 1915

BY

HEINRICH RIES AND THOMAS L. WATSON

COPYRIGHT, 1925, 1931

BY

HEINRICH RIES AND ADIE S. WATSON, ADMINISTRATRIX

All Rights Reserved

*This book or any part thereof must not
be reproduced in any form without
the written permission of the publisher.*

Printed in U. S. A.

Printing
F. H. GILSON CO.
BOSTON

Composition and Plates
TECHNICAL COMPOSITION CO.
CAMBRIDGE

Binding
STANHOPE BINDERY
BOSTON

PREFACE TO FOURTH EDITION

In the preparation of the fourth edition a number of additional references have been added, and those referring to books have been corrected to show later editions.

There has also been added a chapter on the Geology of Reservoirs and Dam Sites, as it represents a branch of Engineering Geology that is attracting much attention at the present time.

ITHACA, N. Y.,
Oct. 1930.

PREFACE

FOR some years the authors of this book have been giving to students of civil engineering in their respective universities a special course in geology as applied to engineering. The method followed by them has met with much success, and since the plan adopted has gradually been put into operation at other universities it has encouraged them to believe that it might be of service to others to prepare the present work.

There are probably but few people of observation and practical experience who doubt the value of proper geological training for the engineer, since he must be prepared to meet and often to solve many problems which involve geological principles. For such knowledge it is necessary that the engineer should have adequate training in at least those fundamental principles of geology which relate to engineering problems.

Among the important questions which the engineer has to consider are the character of the common rocks in their use for building stone and road material; the structure of rocks in relation to tunneling operations, dam and reservoir foundations, landslides, etc.; the geological conditions affecting and controlling underground water supplies; the relation of soils to sewage disposal and water purification, etc. Moreover, some familiarity with such materials as fuels (coal, oil and gas), clays, cements, etc., is also necessary.

There may be difference of opinion as to whether the civil engineer should be grounded in abstract geological principles and afterwards allowed to apply them in the field, or whether the exposition of the necessary principles should be illustrated in each instance by actual cases, which show the application of the principle. The first method does not usually appeal to those who have had much practical experience, nor does it find much favor with the engineering student; moreover, it can hardly be considered successful from the pedagogic standpoint.

The authors have attempted to emphasize throughout the book the practical application of the topics treated to engineering work, because hitherto in many engineering courses of study the subject of Geology has not been given the attention which they think it should receive from both professors and students.

Although this book is intended primarily for civil engineers, it is hoped that it may be of use to others interested in applied geology. For this reason certain parts of the work contain more detail than may seem necessary for the actual requirements of the civil engineer, but any one using it for purposes of instruction will find it convenient to eliminate as much or as little of the subject matter as is desired to meet the special requirements of his course.

For permission to reproduce illustrations from their works, the authors desire to make grateful acknowledgment to Professor L. V. Pirsson, for figures 3, 6, 7, 8, 11, 12, 13, 17, 18, 25, 26, 28, 29, 30, 31, 37, 38, 40, from *Rocks and Rock Minerals*; to Professor W. E. Ford for figure 1 from Dana's *Manual of Mineralogy*; and to Professor E. S. Dana for figures 2, 4, 5, 9, 10, 14, 15, 16, 19, 20, 21, 22, 23, 24, 27, 32, 33, 34, 35, 36, 39, 41 and 42, from *A System of Mineralogy*. The authors are similarly indebted to Professor J. S. Grasty for the photographs reproduced as plates XCII, XCIII, CI and CIII, and to the Macmillan Company for the loan of cuts from Ries' *Economic Geology*. For the loan of other cuts acknowledgment is made under each illustration. Mr. R. E. Somers gave much assistance in the preparation of the work.

ITHACA, N. Y., and CHARLOTTESVILLE, VA.
March 16, 1914.

CONTENTS

CHAPTER	PAGE
I. THE ROCK-FORMING MINERALS	1
II. ROCKS, THEIR GENERAL CHARACTERS, MODE OF OCCURRENCE, AND ORIGIN	46
III. STRUCTURAL FEATURES AND METAMORPHISM OF ROCKS	149
IV. ROCK-WEATHERING AND SOILS	223
V. SURFACE WATERS (RIVERS)	253
VI. SUBSURFACE WATERS	305
VII. LANDSLIDES AND LAND SUBSIDENCE	357
VIII. WAVE ACTION AND SHORE CURRENTS, THEIR RELATION TO COASTS AND HARBORS	376
IX. LAKES: THEIR ORIGIN AND RELATION TO ENGINEERING WORK	411
X. GLACIAL DEPOSITS: THEIR ORIGIN, STRUCTURE AND ECONOMIC BEARING	432
XI. GEOLOGY OF RESERVOIRS AND DAM SITES	446a
XII. BUILDING STONE	447
XIII. LIMES, CEMENT AND PLASTER	510
XIV. CLAY AND CLAY PRODUCTS	527
XV. COAL SERIES	544
XVI. PETROLEUM, NATURAL GAS AND OTHER HYDROCARBONS	575
XVII. ROAD FOUNDATIONS AND ROAD MATERIALS	591
XVIII. ORE DEPOSITS	606
XIX. HISTORICAL GEOLOGY	646
APPENDIX A. GEOLOGICAL SURVEYS	695

ENGINEERING GEOLOGY

CHAPTER I

THE ROCK-FORMING MINERALS

Introduction. — Of the eighty-odd elements known to the chemist only sixteen enter largely into the composition of the outer solid portion of the earth so far as it is accessible to observation. It has been estimated that 98 per cent of the earth's crust is made up of eight elements (Scott). Arranged in their order of abundance the percentages of these elements, as calculated by Professor F. W. Clarke, are:

Oxygen	47.33	Calcium	3.47
Silicon	27.74	Potassium	2.46
Aluminum	7.85	Sodium	2.46
Iron	4.50	Magnesium	2.24

Titanium, carbon, sulphur, hydrogen, chlorine, phosphorus, manganese and barium, are much less abundant, but of importance. With only few exceptions these elements occur combined with each other forming compounds called minerals.

All rocks, with the exception of the glassy igneous ones, are composed of minerals, and since these minerals not only make up the rocks but vary in their resistance to weather, it is necessary that we have a good knowledge of the characters and properties of the important rock-forming ones, in order to be able to identify rocks and judge their value. The present chapter is devoted first, to an account of the general properties of the common rock-forming minerals that are of use in their megascopic determination, and second, to individual descriptions of the more important rock-forming minerals.

Definition of a mineral. — A mineral may be defined as any natural inorganic substance of definite chemical composition. It is usually a solid, generally having definite crystalline structure, and may or may not occur bounded by crystal faces. As a rule external form (crystal faces) is not developed in minerals as they occur in rocks, but usually as crystalline grains marked by irregular boundaries or outlines, because

of interference with one another during growth. Crystalline grains are commonly referred to as *anhedrons*, signifying absence of crystal faces. Altogether about a thousand definite kinds of minerals are known; but the more common rock-forming minerals number less than thirty.

Definition of a crystal. — A crystal may be defined as a solid bounded by flat and somewhat smooth surfaces, called faces, symmetrically grouped about imaginary lines as axes. By *axes* are meant imaginary lines which connect the centers of opposite faces, edges, or solid angles, and which intersect at some point within the crystal. Such a polyhedral form results when the molecules of that particular substance of definite chemical composition possess such freedom of movement as to arrange themselves according to mathematical laws, which result in internal crystalline structure and the outward expression of plane surfaces or faces. Under such conditions the minerals will usually crystallize with outward crystal form, such as cubes, octahedrons, prisms, etc. In the formation of rocks the conditions are sometimes present which permit of definite arrangement of the molecules, and one or more of the minerals assume outward crystal form, as shown in certain types of igneous and metamorphic rocks.

The number of crystal forms is large and yet when they are grouped in their relations to the crystallographic axes they fall into six systems. The names usually given to the six systems of crystal forms and their axial relations are:

I. Isometric system having three axes of equal lengths and intersecting one another at right angles.

II. Tetragonal system having three axes intersecting at right angles, the two lateral axes being of equal lengths, while the vertical axis is longer or shorter than the two lateral ones.

III. Hexagonal system having four axes, the three laterals being of equal length and intersecting at angles of 60° , while the vertical axis is perpendicular to and longer or shorter than the three laterals.

IV. Orthorhombic system having three axes intersecting at right angles and of unequal lengths.

V. Monoclinic system having three axes of unequal lengths, the two lateral ones at right angles to each other, while the vertical axis is oblique to one of the laterals.

VI. Triclinic system having three axes of unequal lengths making oblique intersections with one another.

Twinning. — Crystals frequently appear not to be simple or single forms but compound, in which one or more parts regularly arranged are in reverse position with reference to the other part or parts (Dana).

This peculiar grouping is known as twinning, the different members of such a crystal appearing as if revolved 180° about a line known as the *twinning axis*. The plane normal to the twin axis is called the *twinning plane*, and the plane of union of the two parts is called the *composition plane*. Many minerals frequently exhibit twinning, and in some it serves as an important means in determining them. Feldspars very often show several kinds of twinning, two of which are of importance in megascopic determinations, namely, Carlsbad and albite (multiple) twins (see Figs. 4 to 8, pages 9 and 10). Multiple twinning is characteristic of the plagioclase or soda-lime feldspars, and affords the surest means of distinguishing them from orthoclase (see under *feldspar group*). Carlsbad twinning may be developed in any variety of feldspar, but is generally more frequent in orthoclase than in plagioclase.

General Physical Properties of Rock-making Minerals

The important physical properties of rock-making minerals which are of value in their megascopic determination are *hardness*, *cleavage*, *luster*, *streak*, *color*, *crystal form*, and *specific gravity*. These have not equal weight in determining minerals. The behavior of minerals before the blowpipe and with chemical reagents is an important means of determining them and is comprised under that division of the subject known as determinative mineralogy.

Hardness.—Hardness is an important property of minerals and is of great value in their rapid determination. It may be defined as the resistance of a mineral to abrasion or scratching. The hardness of minerals is usually determined by comparing with Mohs's scale, which comprises ten minerals arranged in the order of increasing hardness, as follows:

- | | |
|-------------|-------------|
| 1. Talc | 6. Feldspar |
| 2. Gypsum | 7. Quartz |
| 3. Calcite | 8. Topaz |
| 4. Fluorite | 9. Corundum |
| 5. Apatite | 10. Diamond |

In testing the hardness of a mineral care must be taken to select a fresh fragment, and not mistake a scratch for a mark left by a soft mineral on the surface of a hard one. If an unknown mineral scratches and in turn is scratched by a member of the scale, its hardness is the same as that of the scale member. Again if the unknown mineral scratches fluorite its hardness is greater than 4, but if it does not scratch apatite and is scratched by it, its hardness is between 4 and 5, approximately 4.5.

In the absence of a scale, the hardness of a mineral may be approximated by use of the following materials: The finger nail will scratch gypsum (2), but not calcite; a copper coin will just scratch calcite(3); and the blade of an ordinary pocket knife will scratch apatite (5).

Minerals sometimes show different degrees of hardness, depending upon the direction in which they are tested. Thus cyanite shows a hardness of 4-5 when scratched in one direction, and of 7 at right angles to this direction.

Cleavage. — When properly tested most minerals exhibit more or less readiness to part or cleave along one or more definite planes. In most minerals possessing crystalline structure the molecules are so arranged that the force of cohesion is less along a particular direction or directions than along others. This property is called *cleavage*. It is a fairly constant property of minerals and is of great value in determining them. Cleavage does not occur at random in a mineral, but is always parallel to possible crystal faces, and is so described. Thus we have cubic cleavage (galena), octahedral cleavage (fluorite), rhombohedral cleavage (calcite), prismatic cleavage (amphibole), basal cleavage (mica). All minerals do not possess cleavage, and comparatively few exhibit it in an eminent degree. Quartz and garnet do not show cleavage, but such minerals as feldspar, amphiboles, pyroxenes, and calcite are distinguished chiefly by their cleavage. Such terms as *perfect*, *imperfect*, *good*, *distinct*, *indistinct* and *easy* are frequently used in accordance with the manner and ease with which cleavage is obtained.

Luster. — The luster of a mineral is the appearance of its surface in reflected light, and is an important aid in the determination of minerals. Two kinds of luster are recognized: *Metallic* luster, the luster of metals, most sulphides, and some oxides, all of which are opaque or nearly so; *nonmetallic* luster, the luster of minerals that are transparent on their thin edges, and in general of light color, but not necessarily so. The more common nonmetallic lusters are described as follows: *Vitreous*, the luster of glass; example quartz. *Resinous*, the appearance of resin; example sphalerite. *Greasy*, the appearance of oil; example some sphalerite and quartz. *Pearly*, the appearance of mother-of-pearl; example talc. *Silky*, the appearance of silk (satin), due to a fibrous structure; example, satin spar and asbestos. *Adamantine*, the brilliant, shiny luster of the diamond. *Dull*, as in chalk or kaolin.

Streak. — By the streak of a mineral is meant the color of its powder. It is frequently one of the most important physical properties to be applied in the determination of minerals, such as hematite and limonite. The color of a mineral in mass may vary greatly from that

of its powder (streak, which is frequently fairly constant), and is usually much lighter. The streak of a mineral may be determined by crushing, filing, or scratching, but the most satisfactory method is to rub the sharp point of a mineral over a piece of white, unglazed porcelain. Small plates, known as streak plates, are made especially for this purpose.

Streak is of most value in distinguishing between the dark-colored minerals like the metallic oxides and sulphides, and is of less value in discriminating between the light-colored silicate and carbonate minerals.

Color. — Color is one of the most important properties of minerals, and, when used with proper precaution, it is of great help in their rapid determination. The color of metallic minerals is a constant property; but it may vary greatly in many of the nonmetallic minerals, due to the presence of pigments or impurities, which may be either chemically combined or mechanically admixed. Even the metallic minerals, such as the sulphides (pyrite, marcasite and chalcopyrite) whose color is constant, are susceptible to tarnish (*alteration*), and a fresh surface should always be examined in noting the color.

The color of minerals is dependent upon their chemical composition, in which case it may be *natural*, or it may be due to some foreign substance distributed through them and acting as a pigment, and their color may then be termed *exotic* (Pirsson). Precaution should be used, therefore, in the latter case when color is employed in the determination of minerals.

When pure, the acid radicles, silica and carbon dioxide, and the oxides alumina, lime, magnesia, soda, and potash are colorless. Hence, when these combine to form the corresponding compounds, silicates and carbonates, they are colorless or white. Thus quartz, feldspar, enstatite, tremolite, calcite and dolomite, when pure, are colorless or white. The introduction of the metallic oxides, the commonest one of which is iron, will influence the color, and according to its quantity the mineral will ordinarily exhibit some shade of green, brown, or even black. Examples among the silicate minerals are the iron-bearing members of the amphibole, pyroxene, and mica groups.

Exotic color, as previously stated, may result (1) from the presence of a very small amount of some compound in chemical combination, such as manganese oxide in quartz imparting an amethyst color; or (2) mechanically admixed impurities such as small amounts of hematite in quartz producing the red variety jasper.

Crystal form. — As stated in a preceding paragraph minerals are usually developed in rocks as crystalline grains without definite shape

or outward crystal form. To this statement, however, there are frequent exceptions, especially in the group of porphyritic rocks, where the conspicuously-developed mineral or minerals (*phenocrysts*) frequently exhibit crystal boundaries. When minerals exhibit definite shapes crystal form becomes an important aid for their determination. Because of the fact, however, that minerals composing rocks are more often developed without crystal boundaries, crystal form is less important as an aid in determining them than other physical properties.

Specific gravity.—The specific gravity (density) of a mineral is its weight compared with that of an equal volume of water. In a pure mineral of given composition, it is a constant factor, and is an important aid in identification. The specific gravity of most silicate minerals lies between 2.25 and 3.5; of minerals with metallic luster usually between 4.5 and 10; and of natural-occurring metals as high as 23 (iridium).

As ordinarily carried out in the laboratory, the determination of the specific gravity of a mineral is as follows: The fresh mineral is first weighed in air, which value we may call x . It is then immersed in water and weighed again, and the value may be called y . Then $x - y$ equals the loss of weight in water, or the weight of an equal volume of water. We then have

$$G = \frac{x}{x - y}, \quad G \text{ being the specific gravity.}$$

The determination of specific gravity may be carried out on several different kinds of balances, but one of the most convenient forms is the Jolly balance, shown in Fig. 1. The time required for the whole determination on this balance should not exceed several minutes.

Fracture.—When a mineral breaks irregularly without regard to definite direction it is described as fracture. The appearance of a fracture surface is somewhat characteristic and is commonly designated by the following terms: *Conchoidal*, when the surface presents a somewhat shelly appearance; *fibrous* or *splintery*, when the surface shows fibers or splinters; *hackly*, when the surface is irregular with sharp edges; *uneven*, when the surface is rough and irregular.

Other physical properties of minor importance but nevertheless

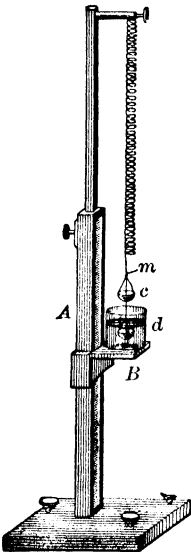

FIG. 1.

useful at times in the determination of minerals are *taste, odor, feel or touch, and magnetism.*

Chemical Tests. — Since, from the definition of a mineral, chemical composition is its most fundamental property, chemical tests with dry and wet reagents form the safest and most satisfactory means of identification. The common rock-forming minerals, however, can usually be readily and quickly determined by their physical properties, and since the equipment of a laboratory is not available in the field, it is essential that a thorough knowledge of the physical properties of minerals be obtained. Tables employing both physical and chemical tests for the determination of minerals are to be found in a number of excellent manuals on determinative mineralogy.

Description of Rock-forming Minerals

The number of known minerals is large; but only a few are of importance as rock-makers. The principal ones from the geological standpoint may be grouped under silicates, oxides, carbonates, sulphates, and sulphides, under which in the order named the individual minerals are treated.

SILICATES

The silicates are the most important rock-forming minerals, since they compose the largest part of the earth's crust. They are salts of silicic acids, the three important ones being orthosilicic acid (H_4SiO_4), metasilicic acid (H_2SiO_3), and polysilicic acid ($H_4Si_3O_8$). Many of the silicates are complex in composition, and the chemical formulæ for some of them are still in doubt. The silicates that are of most importance as rock-forming minerals are the feldspar, feldspathoid, pyroxene, amphibole, mica, olivine, garnet, tourmaline, and epidote groups. A few less common ones that at times are important are also considered in this chapter.

For convenience of treatment the silicates described in this book may be divided into two large groups as follows: *A.* Anhydrous silicates and *B.* Hydrous silicates.

A. ANHYDROUS SILICATES

Feldspars

Introduction. — Feldspar is a family name and not that of a single mineral. It constitutes one of the most, if not the most, important group of rock-forming minerals, nearly 60 per cent of the earth's crust

being composed of feldspar. The members of this group play a fundamental role in the classification of igneous rocks.

Composition. — The species included under the group name are essentially silicates of alumina together with potash, soda, or lime, or their mixtures. The rock-forming feldspars are *orthoclase* (*microcline*), *albite*, and *anorthite*, together with their mixtures. These may be tabulated as follows:

1. Orthoclase (*microcline*) (KAlSi_3O_8), a silicate of alumina and potash.

2. Albite ($\text{NaAlSi}_3\text{O}_8$), a silicate of alumina and soda.

3. Anorthite ($\text{CaAl}_2\text{Si}_2\text{O}_8$), a silicate of alumina and lime.

Mixtures of these are:

Alkalie feldspar ($(\text{KNa})\text{AlSi}_3\text{O}_8$), mixtures of 1 and 2.

Plagioclase feldspar ($\text{NaAlSi}_3\text{O}_8(\text{Ab}) + \text{CaAl}_2\text{Si}_2\text{O}_8(\text{An})$), mixtures of 2 and 3.

The series of plagioclase (soda-lime) feldspars includes a number of species that are isomorphous mixtures of the two end members albite (pure soda feldspar) $\text{NaAlSi}_3\text{O}_8$ (designated Ab) and anorthite (pure lime feldspar) $\text{CaAl}_2\text{Si}_2\text{O}_8$ (designated An).

The intermediate members of this series are mixtures in varying proportions of the two molecules Ab and An, as shown in the annexed table.

Plagioclase Feldspars

Albite.....	Ab_1An_0 to Ab_6An_1	Labradorite.....	Ab_1An_1 to Ab_1An_3
Oligoclase...	Ab_6An_1 to Ab_3An_1	Bytownite.....	Ab_1An_3 to Ab_1An_6
Andesine...	Ab_3An_1 to Ab_1An_1	Anorthite.....	Ab_1An_6 to Ab_0An_1

The percentages of the various oxides in each feldspar variety are shown in the following table:

PERCENTAGES OF OXIDES IN THE FELDSPARS OF THE PLAGIOCLASE GROUP

	SiO_2 .	Al_2O_3 .	Na_2O .	CaO .
Ab_1An_0	68.7	19.5	11.8	0.0
Ab_6An_1	64.9	22.1	10.0	3.0
Ab_3An_1	62.0	24.0	8.7	5.3
Ab_1An_1	55.6	28.3	5.7	10.4
Ab_1An_3	49.3	32.6	2.8	15.3
Ab_1An_6	46.6	34.4	1.6	17.4
Ab_0An_1	43.2	36.7	0.0	20.1

The potash varieties of feldspar, orthoclase and microcline, represented by the formula KAlSi_3O_8 or $\text{K}_2\text{O} \cdot \text{Al}_2\text{O}_3 \cdot 6\text{SiO}_2$, can not be distinguished from each other with the naked eye, and may be regarded

as identical, and the two designated as orthoclase. In most cases the feldspars are either mixtures (intimate) of orthoclase and albite in varying proportions, with the former usually greatly in excess, designated as *alkalic* feldspar; or mixtures of albite and anorthite, designated as *plagioclase* or soda-lime feldspar.

Form. — The feldspars may be either monoclinic (orthoclase) or triclinic (microcline and plagioclase group) in crystallization. The crystals may be stout and thick (Fig. 2), or thin and tabular (Fig. 3)

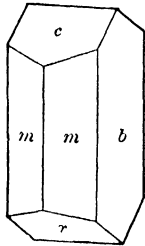

FIG. 2.

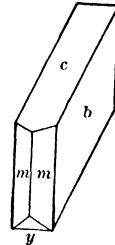

FIG. 3.

in habit; sometimes long and columnar. They often exhibit a tendency to assume crystal form, yet perfect crystals are rarely observed except when developed as phenocrysts in porphyritic igneous rocks (see Chapter II). They are commonly developed in rocks as formless grains without crystal boundaries.

Twinning. — Twinning is very common in the feldspars (Figs. 4 to 8) and is an important means of distinguishing between the potash

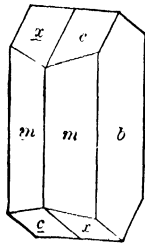

FIG. 4.

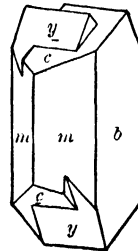

FIG. 5.

(orthoclase) and soda-lime (plagioclase) varieties with the unaided eye. Carlsbad twins (Figs. 4 and 5), the name being derived from Carlsbad in Bohemia where specimens of great perfection have been found, are the most commonly-occurring forms in orthoclase. Multiple (polysyn-

thetic or albitic) twinning (Figs. 6 to 8), which results in the cleavage surface of the twinned feldspar being marked by parallel striations, is characteristic of the soda-lime (plagioclase) series, and when visible to the unaided eye it affords the surest proof that the feldspar belongs to the plagioclase group. This form of twinning is crystallographically impossible in orthoclase. If present and visible to the naked eye, the striations are readily observed by turning the crystal or grain in the

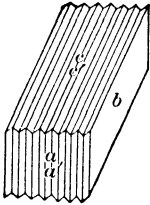

FIG. 6.

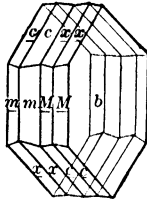

FIG. 7.

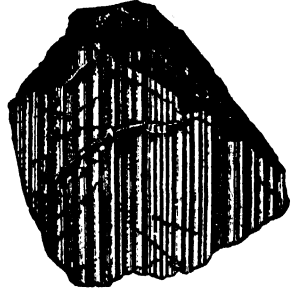

FIG. 8.

sunlight, so as to catch the reflection from the cleavage face. Other forms of twinning in feldspars occur; but are of little or no importance in their megascopic determination.

Cleavage. — All species of feldspar possess good *cleavage* in two directions, which intersect either at 90° as in orthoclase, or at about 86° as in the plagioclase series. The difference, however, in angle of intersection of the cleavages is too small to be of use in distinguishing between plagioclase and orthoclase by the unaided eye, unless accurately measured. If the feldspar grains as developed in rocks are of sufficient size, the cleavages can be readily observed by reflected light.

Physical properties. — Fracture of feldspars in directions other than those of cleavage is uneven, usually poorly developed. Brittle. Hardness 6. Specific gravity varies with chemical composition: Orthoclase = 2.55, albite = 2.62, anorthite = 2.76; the other species (mixtures) vary between these limits. Luster vitreous; on cleavage faces often pearly. Streak white, not characteristic. The feldspars exhibit a variety of color. Colorless, sometimes transparent and glassy, white, gray, red, and green. In rocks, colorless and glassy feldspars are limited to the fresh and recent lavas. Some shade of red is common to orthoclase and the alkalic feldspars, while the plagioclase or soda-lime feldspars are commonly gray or white. Feldspar is frequently the dominant coloring mineral in granites.

Chemical tests. — Orthoclase and albite are insoluble in ordinary acids, but with increase in lime in the plagioclase group they become slowly soluble (labradorite to anorthite). The lime-rich varieties fuse more easily than do albite and orthoclase.

Alteration. — Feldspars commonly alter to kaolin in the belt of weathering, when acted on by water containing carbon dioxide, with the separation of free silica and alkaline carbonates. Alteration of the lime-bearing species is apt to be accompanied by the formation of calcite. Under conditions of dynamic metamorphism (see Chapter III), or in the presence of hot waters, potash feldspar commonly alters to muscovite (sericite). Alteration of feldspars involving the formation of kaolin¹ is of much importance in the formation of soils. The process is described as *kaolinization*, and is first noted in feldspars by the loss of luster, and the mineral becoming dull and chalky or earthy in appearance. Usually in the feldspar-bearing rocks used for building and ornamental purposes, it has been observed that the lime-soda feldspars are more susceptible to alteration than orthoclase. Both orthoclase and plagioclase are less durable than quartz, with which they are frequently associated, but they are not to be regarded as unsafe on this account.

The changes involved in the alteration of feldspar to kaolin and muscovite have been expressed chemically as follows (Pirsson):

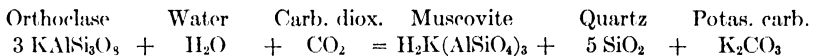
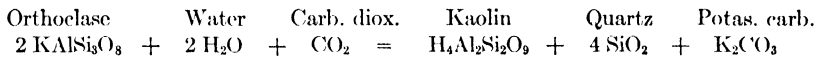

Other forms of alteration of feldspars are known.

Occurrence. — The feldspars are probably more widely distributed than any other group of rock-forming minerals. They occur in most of the igneous rocks, such as granites, syenites, and lavas; in certain sandstones and conglomerates among sedimentary ones; and in gneisses of the metamorphic rocks. Hence feldspar is an important constituent of many building stones.

Determination. — The two cleavages of 90° or nearly so, hardness, luster, and color usually serve to distinguish the feldspars from other minerals which they closely resemble. When observed, the striations on good cleavage surfaces are the surest means of distinguishing plagioclase or soda-lime feldspars from orthoclase. It is not safe, however, in all cases to conclude that a feldspar which does not exhibit striations

¹ Kaolin may sometimes be formed in other ways. See Ries: "Clays, their Occurrence, Properties, and Uses."

is orthoclase, for the twinning is frequently so fine that the lines cannot be detected even with the aid of a good pocket lens.

Feldspathoid Group

Like the feldspars the members of the feldspathoid group are silicates of alumina with soda, potash, and lime. Unlike the feldspars they are greatly restricted in occurrence and are comparatively rare, being found only in certain kinds of igneous rocks, such as nephelite syenites. *Nephelite* and *sodalite* are the two most important members of the group. These are briefly described below.

Nephelite

Composition. — Sodium-aluminum silicate, chiefly $\text{NaAlSi}_3\text{O}_8$, with a few per cent of potash present replacing soda; sometimes also lime.

General properties. — Hexagonal in crystallization; commonly without crystal form as shapeless grains and masses. Cleavage sometimes distinct, usually not good. Fracture somewhat conchoidal. Brittle. Hardness, 5.5–6. Specific gravity 2.55–2.65. Luster vitreous to greasy. White, gray, and yellowish, sometimes reddish. Streak light. Fusible before the blowpipe. Is readily soluble in dilute acid, and on evaporation yields gelatinous silica. It easily alters into various minerals, similar to the feldspars. It occurs in some lavas and in certain kinds of syenite.

Sodalite

Composition. — $\text{Na}_4(\text{AlCl})\text{Al}_2(\text{SiO}_4)_3$ or $3\text{NaAlSi}_3\text{O}_8 \cdot \text{NaCl}$.

General properties. — Isometric in crystallization; crystals rare; usually occurs in rocks as shapeless grains. Cleavage dodecahedral, but of little value in megascopic determination. Fracture uneven. Hardness, 5.5–6. Specific gravity, 2.15–2.3. Luster vitreous, sometimes greasy. Color usually blue, also white, gray, green. Streak white. Fusible before the blowpipe to a colorless glass. Soluble in dilute acids, and on evaporation yields gelatinous silica. Nitric acid solution with silver nitrate, gives a white precipitate of silver chloride. It is a comparatively rare rock mineral, being restricted in occurrence to nephelite-syenites, trachytes, and phonolites.

Mica Group

Composition. — Of the many species included in the mica group the more important ones are:

Muscovite $\text{H}_2\text{KAl}_3(\text{SiO}_4)_3$. Potash mica.

Lepidolite $\text{KLi}[\text{Al}_2(\text{OH},\text{F})]\text{Al}(\text{SiO}_3)_3$. Lithia mica.

Biotite $(\text{H},\text{K})_2(\text{Mg},\text{Fe})_2\text{Al}_2(\text{SiO}_4)_3$. Iron-magnesia mica.

Phlogopite $\text{H}_2\text{KMg}_3\text{Al}(\text{SiO}_4)_3(?)$. Magnesia mica.

Lepidomelane $(\text{H},\text{K})_2\text{Fe}_3(\text{Fe},\text{Al})_4(\text{SiO}_4)_5(?)$. Iron mica.

As illustrated in the above tabulation, the micas form a group of complex silicates (orthosilicates) of aluminum with potassium and hydrogen, magnesium, iron, and lithium. Other species belonging to the

mica group but not listed above show the presence of other elements, such as sodium, manganese, chromium, etc. For megascopic study the micas may be conveniently classified into (a) *light* colored micas (muscovite) and related varieties, and (b) *dark* colored micas (biotite) and related varieties.

Form. — The micas form an isomorphous series crystallizing in the monoclinic system. The crystals are tabular in form, often of hexagonal outline, with flat bases. Crystals are sometimes observed in rocks, but the micas more often occur as flecks, scales, or shreds, without crystal boundaries.

Physical properties. — All micas are characterized by very perfect basal cleavage, which allows them to be split into extremely thin elastic plates or laminae, that are tough and flexible. This property combined with transparency, toughness, and flexibility, makes the large sheets of muscovite of much value for use in stove windows, lamp chimneys, electrical work, etc.

The micas have a wide range of color, dependent chiefly on chemical composition. Colorless, white, gray, green, violet or lilac to red, yellowish to brown, and black. *Muscovite* is colorless, white to gray, sometimes greenish to light brown; *lepidolite* is usually of pink or lilac color; *biotite* is usually brown to black, sometimes dark green; *phlogopite* is pale brown, often coppery; and *lepidomelane* is black to greenish black. The color of mica frequently exerts an important effect on building and ornamental stones containing it. Luster vitreous to pearly or silky; sometimes splendid in the dark-colored varieties. Streak uncolored. Hardness 2-3; easily scratched with the knife. Specific gravity 2.7-3.2.

Chemical tests. — Before the blowpipe the micas vary from easily (*lepidolite*) to difficultly (*biotite*) fusible. They yield little or no water when heated in a closed glass tube, which aids in distinguishing them from other micaceous minerals, such as the chlorites. Most of the micas are insoluble in hydrochloric acid, but when boiled in sulphuric acid the dark-colored ones (*biotite*, etc.) are decomposed and give milky solutions.

Alteration. — Most micas are susceptible to alteration when subjected to the action of weathering processes. Some alter more readily than others, dependent upon their chemical composition. *Muscovite* is very resistant, being often times the product of alteration from other minerals, especially the feldspars (then in minute scales of silvery white color and silky luster, and called *sericite*), but it ultimately loses its elasticity and is probably changed to clay. *Biotite* on account of its high iron content is more liable to decompose on exposure to weather.

Because of this fact the alteration of biotite in some building stones may cause unsightly discoloration at times from the liberation of free iron oxide. This is frequently observed in the natural outcrops of many granites, and it not infrequently happens that on the opening of a new quarry failure to strip the stone below the depth of oxidation, an inferior rock (sappy granite) has been placed on the market. The commonest alteration of biotite, however, is to chlorite (see p. 27), when it loses its elasticity, becomes soft and of a green color. Other members of the mica group alter under similar conditions into different mineral products, according to their composition.

Occurrence. — The commoner micas, muscovite and biotite, have wide distribution in rocks. They are abundant constituents of both igneous and metamorphic rocks, and are components of some sedimentary ones, especially sandstones. Muscovite is a common constituent of granites and some syenites, and especially pegmatites, where it is found in blocks and sheets of large enough size to be used for the purposes mentioned above. It is abundant in the metamorphic rocks, especially in mica schists, often being the main constituent, and in gneisses. Muscovite is frequently a secondary mineral, often called *sericite* and having silky luster, derived from feldspars and minerals of similar composition. The alteration process is called *sericitization* (see Ore-Deposits.)

Biotite occurs in many kinds of igneous and metamorphic rocks. It is a much less frequent constituent of sedimentary rocks because of its ready susceptibility to alteration on account of its iron content. It occurs in many granites, diorites, gabbros, syenites, and peridotites, as well as in their fine-grained equivalents. In metamorphic rocks it is a common mineral in schists and gneisses, and is frequently developed in contact metamorphic zones (see Chapter III).

The other varieties of mica are less abundant and are more restricted in distribution. Lepidolite occurs chiefly in granite pegmatites; phlogopite principally in crystalline limestones; and lepidomelane is found in granites and syenites, especially their pegmatite equivalents.

The kind, quantity, and mode of distribution of mica in building stones, exert an important influence on their durability and workability. When present in abundance and the shreds have parallel arrangement, the rock may split readily along this direction. In quantity mica is an undesirable component of marble since it is apt to weather out and leave a pitted surface. It also interferes at times with the production of a good polish. Although some building stones, such as granite, etc., are rarely free from mica, it is not an injurious constituent unless present

in large quantity, or segregated into large and small areas through the stone as "knots" rendering the rock unsightly and, therefore, undesirable for some uses.

Determination. — Megascopically, the micas may be generally distinguished from other minerals by their very perfect basal cleavage, yielding very thin elastic, tough, and flexible laminae; by their luster and hardness.

Pyroxene Group

Composition. — The pyroxene group includes a number of related species that are important as rock-making minerals. They are metasilicates, salts of metasilicic acid, H_2SiO_3 , in which hydrogen (H_2) is replaced by calcium, magnesium, and ferrous iron as the important bases; sometimes manganese and zinc. Certain other molecules contain the alkalis, and aluminum and ferric iron.

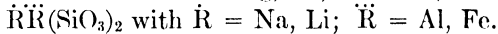
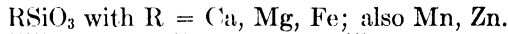

The more important varieties of pyroxenes as rock-making minerals are:

Orthorhombic section:

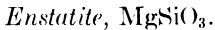

(Bronzite).

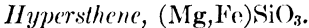

Monoclinic section:

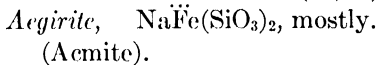
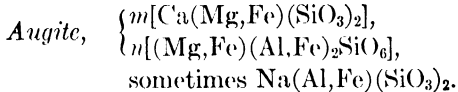
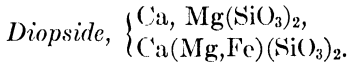

Members of the triclinic section are of no importance megascopically as rock-forming minerals.

Form. — Pyroxenes belong to three systems of crystallization, orthorhombic, monoclinic, and triclinic, but only members of the orthorhombic and monoclinic systems are of importance megascopically as rock-making minerals. They all agree in general crystal habit, a prism with an angle of about 93° and 87° ; usually short, stout, prismatic, or

columnar (Figs. 9 and 10). A cross section of the prism form is usually octagonal in outline as shown in Fig. 11. (Compare with cross section of hornblende, p. 18.) As rock-forming minerals pyroxenes are commonly developed in shapeless grains and masses.

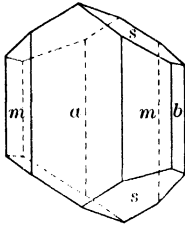

FIG. 9.

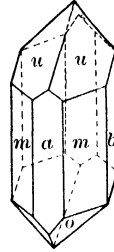

FIG. 10.

Physical properties. — The cleavage is usually very good, developed in two directions parallel to the prism faces, intersecting at an angle of 87° (Fig. 13). It is a fundamental property and serves to distinguish pyroxenes from the amphiboles. Parting in other directions is often developed in some varieties. Fracture uneven. Brittle. Hardness 5–6. Specific gravity, 3.2–3.6.

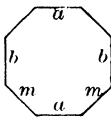

FIG. 11.

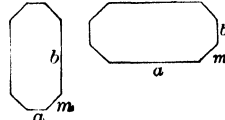

FIG. 12.

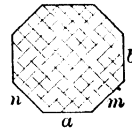

FIG. 13.

The color varies according to the amount of iron present; white to gray and pale green in enstatite and diopside; dark brownish green, greenish black, and brown in bronzite; various shades of green to black in augite; black and greenish black in aegirite. Luster vitreous to resinous, sometimes pearly. Streak varies from white and uncolored to brownish gray and grayish green.

Chemical tests. — Fusibility and solubility vary with the amount of iron present. Enstatite is almost infusible, other varieties much more fusible. They are but slightly acted upon by acids, the iron-rich varieties usually being most affected.

Alteration. — The pyroxenes alter more or less readily into different mineral products, dependent partly upon the kind of process and partly upon their composition. Under the action of weathering serpentine and chlorite are common alteration products of the magnesium- and iron-bearing varieties, often accompanied by carbonates and iron oxides (limonite). Another form of alteration of the pyroxenes that

is of very great geologic importance is into amphiboles, which takes place under metamorphism (especially regional).

Occurrence. — The pyroxenes are chiefly found in igneous rocks, occurring only sparingly in the quartzose ones, but become more abundant in the less siliceous ferromagnesian kinds, such as the basaltic lavas, gabbros, and peridotites (see Chapter II). They are less common in metamorphic rocks, several varieties being noted in some crystalline limestones and gneisses. They are also found in contact zones associated with garnet, but are rarely if ever found in sedimentary beds. They are not very important in the common building stones, and when present in quantity and of the brittle variety they may interfere with the production of a smooth polish.

Determination. — Crystal form and habit when in well-defined crystals, outline (octagonal) of cross section of prism form, and good cleavage in two directions intersecting at 87° , are the most important megascopic properties by which pyroxenes may be distinguished from those minerals they may closely resemble. They may be compared with hornblende, tourmaline, and epidote. In fine-grained igneous rocks it is usually impossible to distinguish between pyroxene and amphibole megascopically. When of sufficient size the following points should be observed: Crystal form when in distinct crystals, outline of cross section of the prismatic form, angle made by intersection of the two prismatic cleavages; also perfection of cleavage which is usually less perfect in pyroxene than in hornblende. Pyroxene commonly occurs in short, stout prismatic forms or grains, while hornblende is developed in needles or long bladed forms. Lack of cleavage, triangular outline of cross section of prism, superior hardness, and high luster, distinguish tourmaline from pyroxene. Epidote can usually be distinguished by unequal cleavage development in two directions, one perfect, the other good, by its characteristic yellow-green color, and by its greater hardness.

Amphibole Group

Composition. — The amphiboles form a strikingly parallel group of minerals to the pyroxenes, the two groups having similar chemical compositions and physical properties. Like the pyroxenes the amphiboles are salts of metasilicic acid (H_2SiO_3) in which hydrogen (H_2) is replaced by certain metals and radicles.

RSiO_3 with $\text{R} = \text{Ca}, \text{Mg}, \text{Fe}$, chiefly; also $\text{Mn}, \text{Na}_2, \text{K}_2$, and H_2 .

$\left. \begin{array}{l} \text{RSiO}_3 \\ \ddot{\text{R}}\ddot{\text{R}}_2\text{SiO}_6 \end{array} \right\}$ with $\ddot{\text{R}} = \text{Al}$ and Fe , chiefly.

$\ddot{\text{R}}\ddot{\text{R}}(\text{SiO}_3)_2$, with $\dot{\text{R}} = \text{Na}$, and $\ddot{\text{R}} = \text{Al}, \text{Fe}$.

For megascopic purposes the important varieties of amphibole are:

Tremolite, $\text{CaMg}_3(\text{SiO}_3)_4$.

Actinolite, $\text{Ca}(\text{Mg}, \text{Fe})_3(\text{SiO}_3)_4$.

Hornblende, $\left\{ \begin{array}{l} \text{Ca}(\text{Mg}, \text{Fe})_3(\text{SiO}_3)_4, \text{ with} \\ \text{Na}_2\text{Al}_2(\text{SiO}_3)_4 \text{ and } (\text{Mg}, \text{Fe})(\text{Al}, \text{Fe})_2\text{SiO}_6. \end{array} \right.$

Arfvedsonite, $\text{Na}_8(\text{Ca}, \text{Mg})_3(\text{Fe}, \text{Mn})_{14}(\text{Al}, \text{Fe})_2\text{Si}_{21}\text{O}_{45}$.

Form. — In crystallization, amphiboles like pyroxenes are orthorhombic, monoclinic, and triclinic. Of these three systems, however, only the monoclinic varieties of amphiboles are of megascopic importance as rock-making minerals. All amphiboles agree in general habit

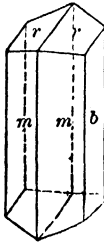

FIG. 14.

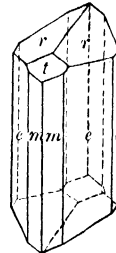

FIG. 15.

and in having a prismatic cleavage of 55 and 125 degrees. They generally occur in long and bladed forms, sometimes fibrous and columnar (Figs. 14, 15, and 16), and as shapeless grains and masses. The outline of a cross section of a prism form is usually hexagonal as shown in Fig. 17.

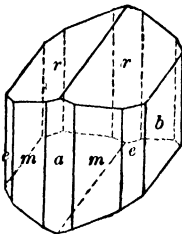

FIG. 16.

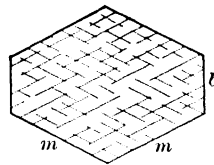

FIG. 17.

Physical properties. — Amphiboles have two directions of perfect cleavage parallel to the prism faces which intersect at angles of 125 and 55 degrees as shown in Fig. 17. The cleavage angle is one of the most distinguishing characteristics of the group. Compare Fig. 17 showing cleavage of amphibole with Fig. 13 which shows the cleavage of

pyroxene. Fracture uneven. Hardness 5-6. Specific gravity 2.9-3.5, according chiefly to the amount of iron present.

The color of amphiboles varies, according to the amount of iron present, from white or gray in tremolite to bright green or grayish green in actinolite, to dark green and black in hornblende, and black in arfvedsonite. Luster vitreous to pearly on cleavage faces; often silky in fibrous varieties. Streak uncolored or grayish to gray-green and brownish.

Chemical tests. — The amphiboles fuse rather easily before the blowpipe, but are only slightly acted on by ordinary acids. The iron-rich varieties are the most easily fusible and show the greatest solution effect from acids.

Alteration. — Since the amphiboles have the same chemical composition as the pyroxenes they show similar alteration under the action of weathering agencies. The commonest changes being, according to composition, into serpentine or chlorite, or both, usually accompanied by carbonates, quartz, and epidote. Eventually they may break down into carbonates, iron oxides, and quartz.

Occurrence. — Amphiboles have abundant and wide distribution in igneous and metamorphic rocks; some varieties being wholly metamorphic or secondary. *Tremolite* and *actinolite* are secondary or metamorphic minerals; the former occurring chiefly in impure crystalline limestones and in contact zones, the latter in crystalline schists. They also occur as common products of alteration in igneous rocks. Owing to its tendency to decompose tremolite is a detrimental mineral in crystalline limestones. *Hornblende* occurs both in igneous and metamorphic rocks. In igneous rocks it is a common constituent in granite, syenite, diorite, some varieties of peridotite, and in many of the fine-grained igneous types. It is often a secondary mineral derived from pyroxene by metamorphic processes when it is known as the variety *uralite*. In the metamorphic rocks it occurs in gneisses and schists. *Arfvedsonite* is more restricted in distribution, being found chiefly in nepheline syenites and related rare porphyries.

Determination. — The most characteristic megascopic properties of amphibole are crystal form and habit, two good prismatic cleavages making angles of 125° , and outline (hexagonal) cross section of the prism form. Amphiboles may be confused megascopically with pyroxene, tourmaline, and epidote. The distinction from pyroxene is given under the latter mineral (page 17). It may be readily distinguished from tourmaline by good cleavage and outline (hexagonal) of the prism cross section; from epidote by two good cleavages, color, and inferior hardness.

Garnet Group

Composition. — Garnets are orthosilicates corresponding to the general formula $\ddot{R}_3\ddot{R}_2(\text{SiO}_4)_3$ or $3\text{RO}\cdot\text{R}_2\text{O}_3\cdot 3\text{SiO}_2$, in which \ddot{R} = Ca, Mg, Fe, Mn; and \ddot{R} = Al, Fe, Mn, Cr, Ti. The group has been divided into a number of varieties which vary considerably in composition, but the most common ones that are of importance as rock minerals are:

Grossularite, $\text{Ca}_3\text{Al}_2(\text{SiO}_4)_3$.

Pyrope, $\text{Mg}_3\text{Al}_2(\text{SiO}_4)_3$.

Almandite (common garnet), $\text{Fe}_3\text{Al}_2(\text{SiO}_4)_3$.

Andradite (melanite), $\text{Ca}_3\text{Fe}_2(\text{SiO}_4)_3$.

Form. — Garnets crystallize in the isometric system commonly as rhombic dodecahedrons or icositetrahedrons (Figs. 18 and 19), rarely as octahedrons; sometimes in combination of the first two (Fig. 20). They very often occur in rocks without crystal boundaries as grains and granular aggregates having rounded or irregular outlines.

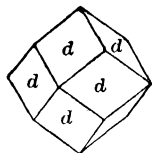

FIG. 18.

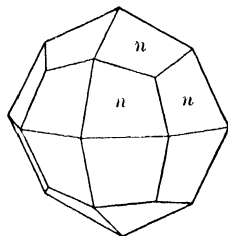

FIG. 19.

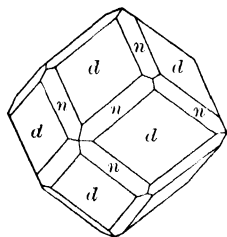

FIG. 20.

General properties. — The cleavage is generally poorly developed and of no value as a megascopic feature. Fracture subconchoidal to uneven. Brittle. Hardness 6.5–7.5. Specific gravity 3.15–4.3, varying with the composition, common garnet being 4.0. Color is variable according to the composition. *Grossularite*, colorless to white, pale shades of pink, yellow, green, and brown; *pyrope*, deep red to nearly black; *almandite*, deep red to brownish red; *melanite*, a variety of *andradite*, is black. Streak white. Luster vitreous, sometimes inclining to resinous.

Chemical tests. — The garnets fuse readily before the blowpipe. They are only slightly acted upon by acids, except andradite which is attacked quite strongly. When evaporated the acid solution yields gelatinous silica.

Alteration. — Some garnets are quite resistant to atmospheric agencies. Dependent upon composition they may alter to chlorite or serpentine, less frequently to hornblende. Of the different known

minerals into which common garnet alters, chlorite is the commonest. Alteration of those varieties containing iron may be accompanied by limonite as one of the products.

Occurrence. — Garnets have wide-spread distribution as accessory constituents of metamorphic and sometimes igneous rocks. The different varieties are unequally distributed as rock minerals, some being more restricted than others. *Grossularite* is chiefly found in crystalline limestones resulting both from contact and regional metamorphism. *Pyrope* occurs in some basic igneous rocks, peridotites and the serpentines derived from them. *Almandite* is especially found in schists and gneisses, sometimes in pegmatites, rarely in granites, and in zones of contact metamorphism. *Andradite*, variety *melanite*, is restricted in distribution to certain types of igneous rocks. It is a common mineral in contact metamorphic ore-deposits. It is not, however, a very important megascopic mineral.

Determination. — The more important megascopic characters of the garnets by which they may be recognized from other minerals are: Crystal form, lack of cleavage, luster, color, and hardness.

Olivine Group

Composition. — Olivine (chrysolite) is an orthosilicate corresponding to the general formula R_2SiO_4 , in which $R = Mg, Fe$. It may be regarded as a variable mixture of magnesium orthosilicate (Mg_2SiO_4) *forsterite* and the ferrous orthosilicate (Fe_2SiO_4) *fayalite*. It is the only member of the group that is of importance as a rock mineral.

General properties. — Orthorhombic in crystallization, but crystal form is not an important megascopic property, since olivine usually occurs as a rock constituent in formless grains and granular masses, and rarely in distinct crystals. Cleavage not distinct. Fracture conchoidal. Hardness 6.5–7. Specific gravity 3.27–3.37, according to the amount of iron present. Color green, varying from olive-green to yellow-green; bottle-green very common. Luster vitreous. Streak uncolored, rarely yellowish.

Chemical tests. — Before the blowpipe olivine varies from nearly infusible to fusible according to whether little or very much iron is present. It is soluble in acids yielding gelatinous silica on evaporation.

Alteration. — The commonest form of olivine alteration is into serpentine and iron oxide. The alteration begins from the outer surface and cracks developing serpentine fibers normal to the surfaces. The separated iron oxide is deposited along the cracks. Other kinds of alteration of olivine occur but are of less importance.

Occurrence. — Olivine occurs chiefly as a characteristic mineral of the less siliceous igneous rocks, such as gabbros, peridotites, and basaltic lavas. It also occurs in metamorphosed magnesian limestones and in some schists.

Determination. — General appearance and association, green color, lack of good cleavage, and superior hardness usually distinguish olivine from those minerals it may resemble.

Epidote Group

Composition. — Epidote, the most important rock-making member of the group, is a basic orthosilicate of calcium and aluminum with variable iron, corresponding to the formula $\text{HCa}_2(\text{Al,Fe})_3\text{Si}_3\text{O}_{13}$. Proportions of aluminum to iron vary from 6:1 to 3:2.

Form. — Monoclinic in crystallization, but usually crystal form is of little value in megascopic determination. Crystal habit of epidote is prismatic, sometimes in slender, needle-like forms, often in aggregates. Its common occurrence in rocks is in formless grains and aggregates of grains.

General properties. — Cleavage unequally developed in two directions, one perfect parallel to *c*, the other imperfect parallel to *a*. Fracture uneven. Brittle. Hardness 6-7. Specific gravity 3.3-3.5. Color usually some shade of green, pistachio-green or yellowish-green being the most characteristic. Luster vitreous. Streak uncolored, or grayish.

Chemical tests. — Before the blowpipe epidote fuses with intumescence to a black mass. It is partly soluble in hydrochloric acid. Yields water in closed tube on strong ignition. When fused and dissolved the solution gives gelatinous silica on evaporation.

Occurrence. — Epidote occurs abundantly as a secondary mineral in igneous rocks derived from the alteration of ferromagnesian minerals and lime-soda feldspars, and commonly accompanies chlorite. It has a similar occurrence in crystalline schists and gneisses. It is a common constituent of metamorphic rocks rich in lime derived both by regional and contact metamorphism. In some cases the mineral has been reported as an original constituent of igneous rocks.

Determination. — The peculiar yellowish-green color, superior hardness, and two unequally-developed cleavages, one perfect, the other poor, are usually sufficient to distinguish epidote megascopically from those minerals with which it might be confused.

Staurolite

Composition. — Variable, but chiefly a ferrous iron-aluminum silicate corresponding to the formula $\text{HFeAl}_6\text{Si}_2\text{O}_{13}$ or $(\text{AlO})_4(\text{AlOH})\text{Fe}(\text{SiO}_4)_2$.

Form. — Staurolite is orthorhombic in crystallization, usually in distinct crystals of prismatic habit. (Fig. 21.) Crystals are commonly short and stout, less often long and slender. Cruciform twins are very common (Figs. 22 and 23).

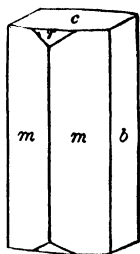

FIG. 21.

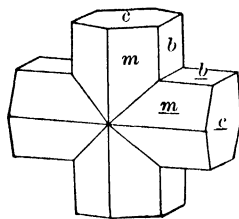

FIG. 22.

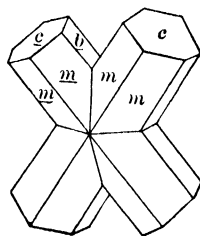

FIG. 23.

General properties. — Cleavage distinct but interrupted. Fracture subconchoidal. Hardness 7–7.5. Specific gravity 3.65–3.75. Color reddish-brown to brownish-black. Luster resinous to vitreous, dull to earthy when altered or impure.

Chemical tests. — Staurolite is practically infusible before the blowpipe and insoluble in acids, but on intense ignition in a closed tube it yields a little water.

Occurrence. — Staurolite occurs in metamorphic rocks, especially the crystalline schists (mica schists chiefly), in slates, and sometimes in gneiss.

Tourmaline

Composition. — Tourmaline is a complex silicate of boron and aluminum with hydroxyl and fluorine, magnesium, iron, and sometimes the alkalis.

Form. — Tourmaline crystallizes in the rhombohedral division of the hexagonal system, the faces being in threes or multiples of threes. (Figs. 25 and 26.) The crystals are commonly prismatic, ranging from short and thick (Fig. 24) to slender and acicular. The prism faces are often vertically striated. Outline of cross section of prisms is characteristically trigonal like a spherical triangle, three-sided or nine-sided. This

triangular cross section (Figs. 25 and 26) is very characteristic of rock-making tourmaline. Tourmaline is less often developed in shapeless grains and masses.

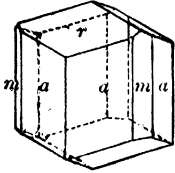

FIG. 24.

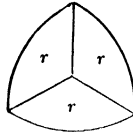

FIG. 25.

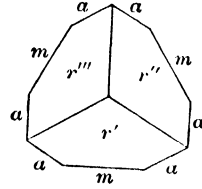

FIG. 26.

General properties.— Cleavage not noticeable. Fracture sub-conchoidal to uneven. Brittle. Hardness 7–7.5. Specific gravity 2.98–3.20. Color variable, but that of the common rock-making variety is black. Luster vitreous. Streak uncolored.

Chemical tests.— Tourmaline is difficultly fusible before the blowpipe and is insoluble in acids.

Occurrence.— Tourmaline is widely distributed as a constituent of crystalline schists and in the more acid igneous rocks, such as granites and their accompanying pegmatites. It also occurs in gneiss and clay slates, and is a common mineral of contact metamorphic zones. As indicated by its composition tourmaline is one of the most common and characteristic minerals formed by pneumatolytic action (see Chap. III).

Determination.— Characteristic triangular cross section, crystalline form, black color, absence of cleavage, and hardness are the more important megascopic properties by which it can usually be identified.

B. HYDROUS SILICATES

The hydrous silicates that are of most importance as rock-making minerals are *kaolinite*, *talc*, *serpentine*, *chlorite*, and the *zeolites*. These are entirely of secondary origin, and may be formed either by weathering or by heated circulating waters or vapors acting on rock masses. They are of most importance in sedimentary and metamorphic rocks, and are of no importance in fresh igneous rocks. They occur as constituents in the wall rock of many ore-deposits formed by the alteration of the original silicate minerals by varying geologic processes (see Chapter on Ore-Deposits).

Kaolinite

Composition.— Kaolinite is a hydrous aluminum silicate corresponding to the formula $H_4Al_2Si_2O_9$ or $Al_2O_3 \cdot 2SiO_2 \cdot 2H_2O$.

Form. — Kaolinite crystallizes in the monoclinic system as minute scales or plates with sometimes hexagonal outlines, but the crystal form is of no importance in megascopic determinations. It may occur in clay-like masses, or scattered irregularly through feldspathic rocks.

General properties. — Color white; often variously colored by impurities. Luster usually dull earthy. Hardness 2–2.5. Specific gravity 2.6–2.63. Neither hardness nor gravity is serviceable for practical tests. It usually has an unctuous, greasy feel, and is plastic.

Chemical tests. — Kaolinite is infusible before the blowpipe, and is insoluble in acids. When moistened with cobalt nitrate and ignited it becomes blue. Heated in the closed tube it gives water.

Occurrence. — Kaolinite is of widespread occurrence. It is a common constituent of clay, and is always a secondary mineral, formed usually by the weathering of aluminous silicate minerals, chiefly feldspars. Derivation of kaolinite from orthoclase by weathering may be represented as follows:

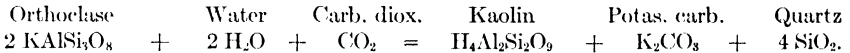

This process is referred to as *kaolinization* and the reaction is described under feldspars (page 11). By it rock-masses are decomposed and soils formed. Extensive deposits often result from the alteration of aluminous rocks and when not discolored by iron oxide and other impurities form the sources of china and white ware clays (see Chapter on Clays). Deposits of clay of variable thickness and extent, showing all degrees of admixture with sand, etc., and variously discolored by different impurities, occur. Other hydrous-aluminous silicates may be present in clays, but they are difficult to recognize by the unaided eye. Masses of sericite are sometimes mistaken for kaolinite.

Talc

Composition. — Talc is an acid metasilicate of magnesium, $\text{H}_2\text{Mg}_3(\text{SiO}_3)_4$ or $3\text{MgO} \cdot 4\text{SiO}_2 \cdot \text{H}_2\text{O}$, containing $\text{SiO}_2 = 63.5$, $\text{MgO} = 31.7$, $\text{H}_2\text{O} = 4.8$.

Form. — The crystal form is doubtful, probably orthorhombic or monoclinic, but it is of no importance in megascopic work since it is rare. It commonly occurs in foliated masses, sometimes in stellate groups, compact, and fibrous.

Two varieties of talc are usually recognized, namely: (1) *Foliated talc* having light green to white color, a pronounced greasy feel, and foliated structure. (2) *Steatite* or *soapstone*, a somewhat impure form

of talc, usually some shade of green in color, and fine- to coarse-granular massive in structure. Frequently impure from the presence of such minerals as mica, chlorite, tremolite, etc. Extensively used for sinks, laundry tubs, etc.

General properties. — Talc, like mica has perfect basal cleavage, the laminae being flexible but inelastic. Characteristic greasy feel. Hardness 1. Specific gravity 2.7–2.8. Color silvery-white to apple-green, sometimes gray to dark green. Luster pearly on cleavage surfaces. Streak light-colored.

Chemical tests. — Talc is difficultly fusible and not acted on by acids. Yields water in closed tube only on intense ignition.

Occurrence. — Talc is a secondary mineral derived by alteration from non-aluminous magnesian silicates, such as olivine, enstatite, tremolite, etc. Its derivation from enstatite may be represented chemically as follows:

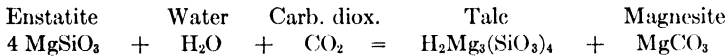

It is found as an alteration product of igneous rocks, especially the peridotites and pyroxenites, but it is commonest in the crystalline schists forming an important constituent in several varieties, such as the talc schists, etc. (See under Metamorphic Rocks.) In some metamorphic rocks like soapstone, talc may form practically the entire rock-mass.

Important occurrences of talc and soapstone are found in the crystalline rocks of the eastern United States, extending from Vermont to Georgia, and large deposits of soapstone are quarried in the Albemarle-Nelson counties belt in Virginia.

Serpentine

Composition. — Serpentine is a hydrous-magnesium silicate, $\text{H}_4\text{Mg}_3\text{Si}_2\text{O}_9$ or $2\text{H}_2\text{O} \cdot 3\text{MgO} \cdot 2\text{SiO}_2$, containing $\text{SiO}_2 = 44.1$, $\text{MgO} = 43.0$, $\text{H}_2\text{O} = 12.9$.

Form. — Optically serpentine is probably monoclinic, but it occurs only in pseudomorphic crystals. It is usually compact or granular massive, often fibrous, the fibers of which are flexible and can be easily separated from each other.

Varieties. — Several varieties of serpentine are recognized.

Ordinary serpentine. — Massive, opaque, and of various shades of green.

Chrysotile. — Fibrous (asbestiform) variety, usually occurring in seams in the massive variety. This is the asbestos of commerce in most part.

Precious serpentine. — Massive, dark green in color, and translucent. The spotted green and white varieties are called *ophiolite* or *ophicalcite*. In these the white areas are calcite and the green usually serpentine, sometimes with a core of pyroxene (?) as at Moriah, N. Y. (See under Marbles.)

General properties. — The cleavage is basal sometimes distinct, but of no importance as a megascopic property. Hardness 2.5–5.0, usually 4. Specific gravity variable, fibrous 2.2–2.4, massive 2.5–2.7. Color is usually some shade of green or yellow, with various shades of black, red, or brown noted; not apt to be uniform, but variegated showing mottling in lighter and darker shades of green. Luster is greasy and wax-like in the massive varieties, and silky in the fibrous. Feel smooth or greasy. Streak white. Fracture conchoidal or splintery in massive varieties. Translucent to opaque.

Chemical tests. — Serpentine fuses with difficulty before the blowpipe, is decomposed by hydrochloric acid, and in the closed tube yields water on ignition.

Occurrence. — Serpentine is a secondary mineral formed as an alteration product from non-aluminous magnesian silicates, such as olivine, pyroxene, and amphibole in igneous and metamorphic rocks. Its derivation from olivine may be shown chemically as follows:

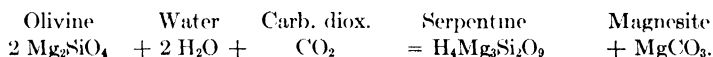

Serpentine may also be derived from the above minerals by the action of heated waters. It is a common and important constituent of the serpentine or verd antique marbles used as an ornamental stone, and in these it occurs mixed with calcite or dolomite (see Chapter on Building Stones, also under Metamorphic Rocks).

Chlorite

Chlorite is the name of a group of hydrous silicates, so named on account of their green color, but because of the difficulty to distinguish them from each other megascopically they are included under the group name *chlorite*. They are secondary minerals and closely resemble the micas in crystal form and cleavage, but are distinguished from them by their folia being soft and inelastic.

Composition. — The chlorites are hydrous silicates of aluminum with magnesium and ferrous iron. Clinocllore, the most common

member of the group, has the formula $H_8(Mg,Fe)_5Al_2Si_3O_{18}$ or $4H_2O.5(Mg,Fe)O.Al_2O_3.3SiO_2$.

Form. — The chlorites are monoclinic in crystallization, forming six-sided tabular crystals, but since distinct crystals are rare, crystal form is not an important megascopic property. Chlorite commonly occurs in irregular flakes and scales.

General properties. — Like mica, chlorite has perfect basal cleavage, the folia of which are flexible and tough, but unlike mica are inelastic. Color green of various shades, usually dark green. Luster of cleavage surface somewhat pearly. Hardness 2–2.5. Specific gravity 2.65–2.96. Streak white to pale green.

Chemical tests. — The chlorites are infusible or difficultly so before the blow-pipe, and are insoluble in hydrochloric acid, but are decomposed by boiling sulphuric acid, giving a milky solution. They yield water in closed tube on ignition.

Occurrence. — Chlorite is a common and widespread mineral and is of secondary origin. It is a common constituent of the crystalline schists, and in some (chlorite schist) it is the predominant mineral. It occurs as a secondary mineral in igneous rocks derived from the alteration of pyroxenes, amphiboles, micas, etc. The green color of many igneous rocks and many metamorphic ones such as schists and slates, is due to chlorite. The green slates owe their color to the finely disseminated particles of chlorite as the coloring matter. Chlorite also occurs as a common product of hydrothermal action along some ore-bodies, especially those associated with volcanic rocks (see Chapter on Ore-Deposits).

Determination. — The chlorites are characterized by their green color, perfect basal cleavage, and inferior hardness. They resemble most closely the micas from which they can be distinguished by their inelastic folia.

Zeolite Group

Composition. — The zeolites form a large group of hydrous silicates of aluminum with calcium and sodium, rarely potassium, as the important bases. They show close similarities not only in composition but in their association and mode of occurrence as well. The name is derived from two Greek words meaning *to boil* and *stone*.

Among the more common members of the group are:

Natrolite, $Na_{12}Al_2Si_3O_{10} + 2H_2O$. Orthorhombic.

Analcite, $NaAl(SiO_3)_2 + H_2O$. Isometric.

Stilbite, $(Na_2, Ca)Al_2Si_6O_{16} + 6H_2O$. Monoclinic.

Heulandite, $H_4CaAl_2(SiO_3)_6 + 3H_2O$. Monoclinic.

General properties. — The zeolites are usually well crystallized, four of the six crystal systems being represented by members of the group. They are usually

colorless or white, sometimes yellow or red. Luster vitreous. Hardness 3.5-5.5, and can be scratched with the knife. Specific gravity 2-2.1.

The members of the group behave similarly before the blowpipe, most of them fusing readily with intumescence, hence the name. They dissolve in hydrochloric acid, some yielding gelatinous silica on evaporation.

Occurrence. — The zeolites are secondary minerals, occurring chiefly in cavities and fissures of igneous rocks, derived from the alteration of feldspars and feldspathoids, by circulating waters and steam. They are especially common in the basaltic lavas filling cavities and coating joint-planes, and are often associated with quartz and calcite. The amygdulæ of lavas are frequently composed entirely or partly of zeolites, giving rise to the amygdaloidal structure of such rocks.

Determination. — The zeolites are characterized by their light color, low specific gravity, moderate hardness, decomposition by hydrochloric acid, and ready fusibility with intumescence. Crystal form is also an important aid at times in distinguishing the individual species.

OXIDES

The oxides that are of importance as rock-making minerals include quartz (SiO_2), corundum (Al_2O_3), and the *iron ores* belonging to the group of oxides, both anhydrous and hydrous.

Quartz

Composition. — Silicon dioxide, SiO_2 . Oxygen = 53.3, silicon = 46.7 when pure; often contains various impurities.

Form. — Quartz crystallizes in the hexagonal system, a common form being a hexagonal prism terminated by a six-sided pyramid (Fig. 27). The prism and pyramid faces are frequently unequally developed; at times the prism faces are entirely absent. Often, however, the crystals are elongated with a marked development of the prism faces (Fig. 28).

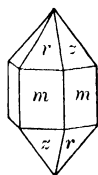

FIG. 27.

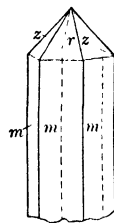

FIG. 28.

Except when formed in cavities, or as phenocrysts in some porphyries, crystal form is not often observed in rock-making quartz. Its usual occurrence in rocks is as shapeless grains and masses.

General properties. — Megascopically quartz may be said not to possess cleavage, which generally serves to distinguish it from feldspar.

Fracture conchoidal. Hardness 7. Specific gravity 2.66. Color varies widely from colorless or white through gray and brown to black, sometimes yellow, red, pink, amethyst, green, and blue. Luster vitreous, sometimes greasy. Streak white. Transparent to opaque. Brittle to tough.

Chemical tests.—Infusible before the blowpipe and insoluble in acids except hydrofluoric acid. It is very resistant to weathering processes, being altered chiefly by physical (disintegration) rather than by chemical forces (decomposition).

Occurrence.—Quartz is the most common of minerals, having widespread occurrence in igneous, sedimentary, and metamorphic rocks. It is an important constituent of the acid igneous rocks, such as granites, rhyolites, pegmatites, etc., and it may occur as phenocrysts as well as in the groundmass of the acid porphyries. In metamorphic rocks it occurs in gneisses and schists, and is the predominant constituent in quartzites, many of which are composed almost entirely of it. It is common in sedimentary rocks, forming the principal mineral in sandstones. It crystallizes from aqueous solutions, both hot and cold, being deposited in fissures or other cavities, and forms the most common vein and gangue mineral of ore deposits. It is associated in rocks chiefly with feldspar.

Varieties.—In addition to the crystalline anhydrous form of quartz, many different forms of silica occur to which varietal names are given, dependent upon color, structure, and other properties. These represent amorphous or cryptocrystalline silica, and have probably formed in most cases on evaporation of solutions containing soluble silica. They are not important as megascopic constituents of igneous and metamorphic rocks, but are of some importance in sedimentary ones.

Some of the more important varieties are:

(a) *Chalcedony*. Amorphous quartz of variable color with waxy luster, usually found lining or filling cavities in rocks.

(b) *Agate*. A variegated chalcedony, in which the different colors are usually arranged in parallel bands, but sometimes irregularly distributed.

(c) *Onyx*.¹ A banded chalcedony like agate.

(d) *Flint*. Resembles chalcedony somewhat, but dull and often dark in color, breaking with pronounced conchoidal fracture. The irregular nodules or concretions and layers of flint occurring in many limestones are called *chert*.

(e) *Jasper*. Opaque quartz usually colored red from hematite.

(f) *Siliceous sinter: geyserite*. Somewhat porous or cellular silica formed by deposition through evaporation or algae from waters containing soluble silica (Plate XIII, Fig. 1). The sinter deposits of the Yellowstone National Park are typical.

¹The onyx marble of commerce is not silica, but calcium carbonate. (See Chap. XI.)

Corundum

Composition. — Aluminum oxide, Al_2O_3 = oxygen 47.1, aluminum 52.9.

Form. Corundum is hexagonal (rhombohedral) in crystallization. The crystals are usually prismatic, or tapering hexagonal pyramids, often rounded into barrel shapes. The barrel-shaped forms are common in some syenites. Corundum also occurs as grains and shapeless masses.

General properties. — Parting, resembling perfect cleavage, occurs parallel to the base and in three other directions (rhombohedral), which gives a laminated structure to the mineral in large pieces. Fracture uneven to conchoidal. Hardness 9 (next to diamond in hardness). Specific gravity 3.95-4.10. Color of rock-making corundum is usually dark gray to bluish-gray or smoky. Luster adamantine to vitreous, sometimes greasy. Translucent to opaque. Brittle, sometimes very tough.

Chemical tests. — Infusible before the blowpipe and insoluble in acids. Moistened with cobalt nitrate and intensely ignited it assumes a blue color (aluminum). Corundum is a resistant mineral to weathering processes but it may alter into a variety of aluminous minerals, such as margarite, muscovite, gibbsite, etc.

The varieties usually recognized are: *Ordinary (rock-making) corundum*, *gem corundum*, and *emery*.

Occurrence. — Corundum occurs as an important constituent of some igneous rocks rich in alumina, such as syenites and nepheline syenites, and peridotites, and to a less extent in some other types. It occurs in crystalline schists, in metamorphosed limestones, and in zones of contact metamorphism. Magnetite corundum known as *emery* occurs in veins or lenses in metamorphic rocks, and like ordinary corundum has somewhat extended use as an abrasive.

Determination. — Corundum is characterized chiefly by crystal form when present, its great hardness, luster, and specific gravity.

Iron Ores (Oxides)

The iron ores belonging to the group of oxides that have value as rock-making minerals are: (a) Anhydrous, including *magnetite*, *ilmenite*, and *hematite*; (b) hydrous, *limonite*. These minerals have wide distribution and are frequent constituents of rocks, although from the standpoint of rock-making species they occur chiefly as accessory minerals, and as such do not play so important a rôle as the more

common silicate minerals, such as feldspar, mica, amphibole, pyroxene, etc. They frequently form large bodies concentrated by geologic processes, and excepting ilmenite, constitute the sources of ore for the metal iron.

Magnetite

Composition. — Iron ferrate, Fe_3O_4 or $\text{FeO} \cdot \text{Fe}_2\text{O}_3$ = oxygen 27.6, iron 72.4 ($\text{FeO} = 31.0$, $\text{Fe}_2\text{O}_3 = 69.0$). Ferrous iron sometimes replaced by magnesium. Titanium oxide occurs in variable amounts up to 25 per cent.

General properties. — Isometric in crystallization; commonly in octahedrons (Fig. 29), also in dodecahedrons (Fig. 30), sometimes in combinations of these forms (Fig. 31). Magnetite sometimes occurs in rocks in such small crystals that the form is indeterminate megascopically.

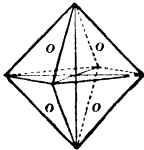

FIG. 29.

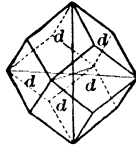

FIG. 30.

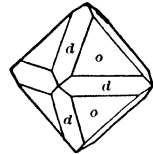

FIG. 31.

Cleavage not distinct; parting octahedral, sometimes well developed. Fracture subconchoidal to uneven. Brittle. Hardness 5.5–6.5. Specific gravity 5.16–5.18. Opaque. Luster metallic. Color iron-black. Streak black. Strongly magnetic. Infusible and slowly soluble in hydrochloric acid. Alters principally to hematite and limonite, sometimes to siderite.

Occurrence. — Magnetite is a very common and widely distributed accessory mineral in rocks of all classes; especially in the crystalline metamorphic and igneous rocks. It occurs as a contact mineral; in ore-bodies due to magmatic segregation; in lenses inclosed in metamorphic rocks, especially schists and gneisses; and as a constituent of the so-called black sands. It is less common in non-metamorphosed sediments, and is of little importance in building stones. Magnetite is an important ore of iron. It is distinguished chiefly by its strong magnetism, its black color and streak, and its hardness.

Ilmenite

Composition. — Ferrous titanate, FeTiO_3 or $\text{FeO} \cdot \text{TiO}_2$ = oxygen 31.6, titanium 31.6, iron 36.8 ($\text{FeO} = 47.3$, $\text{TiO}_2 = 52.7$). It is frequently not pure, but mixed with more or less hematite (Fe_2O_3) and magnetite.

General properties. — Ilmenite is hexagonal (rhombohedral) in crystallization, but crystals in rocks are not often observed by the unaided eye, hence crystal form is not of great importance. It usually occurs in grains and masses, and often in thin plates. Cleavage not developed; parting is sometimes shown. Fracture conchoidal. Brittle. Hardness 5-6. Specific gravity 4.5-5. Opaque. Luster metallic to submetallic. Color iron-black. Streak black to brownish-red. Sometimes magnetic. Infusible and not acted on by acids. After fusion with sodium carbonate, dissolved in hydrochloric acid, and the solution boiled with tin, it assumes a violet color (titanium). Ilmenite alters chiefly into leucoxene (titanite).

Occurrence. — Ilmenite is a common mineral in igneous and metamorphic rocks (gneisses and schists), and its mode of occurrence in these is similar to that of magnetite. Unless it occurs in crystals with definite boundaries, or in grains of sufficient size to be tested chemically, it is difficult and sometimes impossible to distinguish from magnetite. Luster may sometimes serve to distinguish the two minerals, which are associated in some occurrences. The most important occurrence of ilmenite as a megascopic mineral is as segregation bodies of varying size in gabbros and anorthosites. Its high titanium content precludes its use as an ore of iron, but it is used as a source of titanium in the manufacture of ferro-titanium alloys and titanium pigment.

Hematite

Composition. — Iron sesquioxide, Fe_2O_3 = oxygen 30, iron 70. Sometimes contains titanium and magnesium.

General properties. — Hematite, like ilmenite, is hexagonal (rhombohedral) in crystallization, but as a rock mineral it is so rarely found in definite crystals, that crystal form is of little value in its determination. It is found in a variety of forms, but as a rock mineral *specular* or *micaceous hematite*, and *common red hematite* are the varieties of chief importance. Rhombohedral parting resembling cleavage is sometimes developed. Fracture conchoidal to uneven. Brittle in compact form. Hardness 5.5-6.5. Specific gravity 4.8-5.3. Opaque, but translucent red in thin scales. Luster metallic to dull. Color iron black to deep red. Streak cherry-red to reddish-brown. Difficultly fusible. Slowly soluble in concentrated hydrochloric acid. Becomes magnetic when heated in the reducing flame. It alters principally into limonite on exposure to weather.

Occurrence. — Hematite is one of the most widely distributed of minerals. It occurs in igneous, sedimentary, and metamorphic rocks,

both as a primary constituent and as an alteration product. It is a common alteration product of most iron-bearing minerals.

It is the principal ore of iron, and supplies more than 70 per cent of the total annual production of iron ores in the United States. The streak is one of its most distinctive megascopic properties.

Limonite

Composition. — Limonite is the hydrous sesquioxide of iron, $\text{Fe}_2\text{O}_3(\text{OH})_3$ or $2\text{Fe}_2\text{O}_3 \cdot 3\text{H}_2\text{O}$, and contains when pure oxygen = 25.7, iron = 59.8, water 14.5. Often impure and is frequently admixed with other hydrous oxides of iron.

Form. — Noncrystalline. Occurs in earthy masses in rocks, and in deposits in mammillary and stalactitic forms with frequently radiating fibrous structure; also concretionary, and in earthy deposits.

General properties. — Limonite has no cleavage. Luster sub-metallic to dull. Hardness 5–5.5 in the compact mineral. Specific gravity 3.6–4.0. Color is usually some shade of brown, brownish-yellow to very dark opaque. Streak yellow-brown, very characteristic and serves to distinguish it from hematite.

Chemical tests. — It is difficultly fusible before the blowpipe, becoming strongly magnetic after heating in the reducing flame. Slowly soluble in hydrochloric acid, and yields much water when heated in closed tube.

Occurrence. — Limonite is a secondary mineral formed by weathering and alteration from other iron-bearing compounds. It is frequently noted in igneous and metamorphic rocks as small yellowish earthy masses derived from other iron-bearing minerals, such as pyrite, etc., by oxidation and hydration. It forms an essential part of the gossan or "iron hat" of many sulphide veins, as accumulations in beds and irregular bodies forming residual deposits from iron-bearing rocks, especially ferruginous limestones, and in porous earthy form known as bog-iron ore deposited on the bottom of swamps, bogs, and other shallow water bodies through oxidation of iron carbonate chiefly $(\text{FeH}_2(\text{CO}_3)_2)$, and also from iron sulphate. Admixed with more or less clay it forms yellow ocher, and may then be of value as a mineral pigment. It occurs as a pigment or stain in various rocks and is a common cement of many.

Limonite is an important ore of iron and ranks next to hematite in importance in the United States; Alabama, Virginia, Tennessee, and Georgia being the principal producers. Other hydrous oxides of iron are frequently admixed with limonite.

Determination. — Its color, streak, and structure usually suffice to distinguish it from other minerals.

CARBONATES

The carbonates are salts of carbonic acid (H_2CO_3) and are secondary minerals, formed by weathering of other minerals or derived from deeper sources within the earth. They may be deposited either in place or else carried in solution by water containing carbon dioxide into seas and lakes and precipitated by means of organic agencies as limestone, etc. Only two species of the calcite group (*calcite* and *dolomite*) of the anhydrous carbonates are of megascopic importance as rock-forming minerals.

Calcite

Composition. -- Calcite is calcium carbonate, $CaCO_3$ in which $CaO = 56.0$ and $CO_2 = 44.0$ per cent.

Form. -- Calcite crystallizes in the rhombohedral division of the hexagonal system. Crystals are varied in habit, are often perfect, and



FIG. 32.



FIG. 33.

sometimes of large size. The rhombohedron is the most common crystal form (Figs. 32 to 34). Other forms represented by Figs. 35 and 36 sometimes occur. As a rock-forming mineral calcite usually occurs fine to coarse-crystalline granular in marble, compact in ordinary limestones, loose and earthy in chalk, spongy in tufa, and stalactitic in cave deposits.

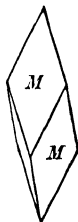

FIG. 34.

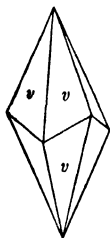

FIG. 35.

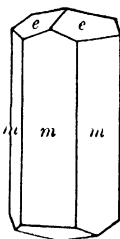

FIG. 36.

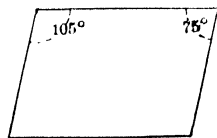

FIG. 37.

General properties. -- Perfect rhombohedral cleavage in three directions intersecting at angles of 75 and 105 degrees (Fig. 37). Hardness 3. Specific gravity 2.72. Color usually white or colorless, but frequently exhibits a variety of color from impurities. Luster

vitreous to earthy. Usually transparent to translucent; opaque when impure. Strong double refraction.

Chemical tests.—Infusible before the blowpipe, but after intense ignition the residue reacts alkaline to moistened test paper. Readily soluble in cold dilute acids with brisk effervescence.

Occurrence.—Calcite is one of the most common and widely distributed of minerals. It is a widespread and abundant constituent of calcareous sedimentary and metamorphic rocks, in which it is the predominant, and sometimes the only, mineral of many limestones, chalk, calcareous marls and tufas, stalagmitic deposits, marbles, and rocks composed of mixtures of calcite and silicate minerals. It is also a common mineral of many veins. Calcareous shales contain a variable quantity of it, and it forms the cementing material of some sandstones. It is found in many igneous rocks as a secondary constituent formed from the alteration of lime-bearing silicates by waters containing carbon dioxide in solution, but in such cases it is usually present in only small amounts. It also occurs as a lining and filling of amygdaloidal cavities in lavas.

Uses.—Rocks composed chiefly or entirely of calcite have varied uses, principal among which may be mentioned the manufacture of natural and Portland cement, the manufacture of lime for mortars and cements, and for agricultural purposes, as a fluxing material in blast furnaces, and as ornamental and building stone, etc. Iceland spar, the pure, transparent and colorless form of calcite, is valuable for optical instruments. (See Chapters on Building Stones and Limes, Cements and Plasters.)

Determination.—Calcite is distinguished by its hardness (3), perfect rhombohedral cleavage, color, and luster. It is readily distinguished from dolomite by the fact that it effervesces freely in cold dilute acid, while dolomite does not.

Aragonite

Aragonite has the same chemical composition as calcite, but differs from it in crystalline form and specific gravity. It is much less common in occurrence than calcite, and has no special importance as a rock-making mineral. It occurs in some onyx marbles.

Dolomite

Composition.—A carbonate of calcium and magnesium, $\text{CaMg}(\text{CO}_3)_2$. Carbon dioxide 47.9, lime 30.4, magnesia 21.7.

Form.—The crystallization of dolomite is similar to that of calcite, hexagonal-rhombohedral. Crystals are usually simple (unit) rhombo-

hedrons, whose faces are often curved (Fig. 38), which sometimes serve to distinguish it from similar crystals of calcite. As a rock-forming mineral it seldom shows crystal form, but usually occurs massive, frequently fine to coarse crystalline granular as in some marbles.



Fig. 38.

General properties. — Like calcite, dolomite has perfect rhombohedral cleavage in three directions, which intersect at angles of nearly 74 and 106 degrees. Hardness 3.5–4. Specific gravity 2.85. Color frequently some shade of pink, but may be white or colorless, and often exhibits a variety of exotic color from the presence of impurities. Luster vitreous; pearly in some varieties. Translucent to opaque.

Chemical tests. — Infusible before the blowpipe, but after intense ignition the residue reacts alkaline to moistened test paper. Readily soluble with effervescence in *hot* dilute acid, but only slowly attacked by *cold* dilute acid, which serves to distinguish it from calcite. It is less soluble in surface or rain waters than calcite, but on exposure to weather disintegrates more readily than the latter.

Occurrence. — As a rock-forming mineral dolomite has its principal occurrence in sedimentary and metamorphic rocks, such as limestones and marbles. Its occurrence in these rocks is similar to that of calcite, and the two are often intimately mixed, with nearly every degree of transition between them.

Determination. — The curved faces of crystals help to distinguish dolomite from calcite, but the surest test is the difference in the behavior of the two minerals to cold dilute acid (see under Calcite above). From other minerals which it may resemble, dolomite is distinguished by its rhombohedral cleavage and inferior hardness (3.5–4).

SULPHATES

Of the large number of sulphate minerals, only two, *gypsum* and *anhydrite*, are of importance as rock-forming minerals. Like the carbonates the rock-making sulphates are secondary, derived from previously existent minerals. Most of the sulphates are soluble and are carried by flowing waters to the sea and lakes where they are precipitated on concentration by evaporation under proper climatic conditions (see Chapter on Rocks). The sulphates are salts of sulphuric acid (H_2SO_4).

Gypsum

Composition. — A hydrous calcium sulphate ($\text{CaSO}_4 \cdot 2 \text{H}_2\text{O}$) containing sulphur trioxide 46.6, lime 32.5, water 20.9.

Form.—Gypsum crystallizes in the monoclinic system. The crystals are usually simple in habit, often flattened parallel to the face *b* as shown in Figs. 39 and 40. Twin crystals are common, and are apt to be of arrow-head form. As a rock-forming mineral gypsum commonly occurs in foliated masses with sometimes curved faces, granular to compact, and fibrous.

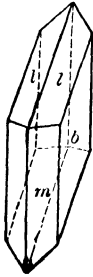

FIG. 39.

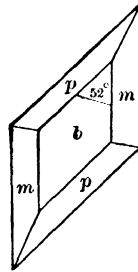

FIG. 40.

The common varieties of gypsum usually recognized are:

(a) *Crystalline* sometimes called *selenite*, in crystals or foliated masses; colorless and transparent.

(b) *Fibrous (satin spar)*, coarse to fine fibrous in appearance with silky luster.

(c) *Alabaster*, a fine-grained white variety.

(d) *Rock gypsum*, massive, granular or earthy, often impure.

General properties.—Gypsum has one perfect cleavage parallel to the face *b* (010) by which it may be parted into thin folia, and a second less perfect cleavage — the two intersecting at angles of 66 and 114 degrees, so that a cleavage fragment has rhombic form. Hardness 1.5-2. Specific gravity 2.32. Colorless or white, but from the presence of impurities it is frequently some shade of red or yellow, brown, and black. Luster of cleavage surface *b* is pearly and shining, of other faces subvitreous; fibrous varieties satin-like; massive varieties frequently glistening, sometimes dull earthy. Transparent to translucent and opaque. Streak white.

Chemical tests.—Gypsum fuses easily before the blowpipe, the moistened mass reacting alkaline to test paper. When fused with sodium carbonate on charcoal and the melt transferred onto silver and moistened, it gives a dark stain. Yields water on heating in a closed tube and becomes opaque. Soluble in hydrochloric acid, and in 400 to 500 parts of water. Ignited at a temperature not exceeding 200 degrees Cent., it loses a part of its water and becomes plaster of Paris, which again takes up water and sets. If strongly ignited gypsum loses all of its water, and is known as dead-burnt plaster.

Occurrence. — Gypsum frequently forms more or less extensive deposits in association with sedimentary rocks, especially limestones, marls, and clays. It is often associated with anhydrite and sometimes with rock salt, and is occasionally found in crystalline rocks, or more rarely veins. Its chief use is for plaster (see Chapter on Limes, Cements and Plasters).

Anhydrite

Composition. — Anhydrous calcium sulphate, CaSO_4 , containing sulphur trioxide 58.8, lime 41.2.

Form. — Anhydrite crystallizes in the orthorhombic system, but as a rock-making mineral crystal form is rarely developed. Its chief occurrence in rocks is in granular to compact masses, less often in foliated or fibrous forms.

General properties. — Anhydrite has three directions of cleavage, but of different degrees of perfection, which yield rectangular or cube-like forms. Hardness 3–3.5. Specific gravity 2.95. Fracture uneven, sometimes splintery. Color usually white but variable as in gypsum. Luster varies from pearly to somewhat greasy and vitreous according to direction; in massive varieties it varies to dull.

Chemical tests. — Behavior before the blowpipe same as for gypsum, except it does not yield water on ignition in the closed tube, which serves to distinguish anhydrite from gypsum.

Occurrence. — Anhydrite, like gypsum, occurs as interstratified beds in sedimentary rocks, especially limestones and shales, and is frequently associated with gypsum and rock salt. Its irregularity is sometimes puzzling to quarrymen, and its slightly greater hardness than gypsum is noticeable to the driller.

PHOSPHATES

Of the large number of known phosphate minerals most of which are rare, only one (*apatite*) is of any importance as a rock constituent. As a megascopic rock-mineral, however, apatite is not of wide occurrence nor of general importance.

Apatite

Composition. — Apatite is a calcium phosphate, containing F or Cl in small quantities; fluor-apatite, $\text{Ca}_4(\text{CaF})(\text{PO}_4)_3$; less often chlor-apatite, $\text{Ca}_4(\text{CaCl})(\text{PO}_4)_3$.

Form. — Crystallizes in the hexagonal system; crystals are prismatic in habit, usually long, sometimes short, and may have rounded ends or be terminated by pyramidal faces (Figs. 41 and 42). It sometimes occurs in granular massive to compact form.

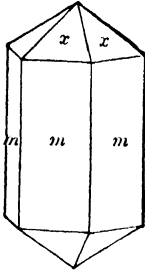

FIG. 41.

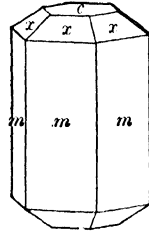

FIG. 42.

General properties. — Imperfect basal cleavage, but of no importance megascopically. Luster vitreous. Hardness 5, just scratched by the knife. Specific gravity 3.15. Color usually some shade of green or brown, sometimes colorless or white and violet. Brittle. Transparent to opaque.

Chemical tests. — Difficultly fusible before the blowpipe; soluble in acids. The addition of ammonium molybdate to the warm nitric acid solution yields a yellow precipitate showing the presence of phosphorus.

Occurrence. — Apatite is a constant accessory constituent of igneous rocks, and as such is usually of microscopic importance only. Its principal megascopic occurrences are in pegmatites, and metamorphosed limestones. In many of its occurrences it is regarded as of pneumatolytic origin (see Chapter on Ore-deposits).

Crystalline apatite is of little economic value at present, since it can not compete successfully with the large deposits of amorphous (rock) phosphate mined for the manufacture of fertilizer.

SULPHIDES

The sulphides form an important group of minerals. They include the majority of the ore minerals (see Chapter on Ore-deposits), but on account of their usual sparing occurrence in rocks, only one of them, *pyrite*, has any special importance megascopically as a rock-making mineral. When present to any extent in rocks used for building and ornamental purposes, the sulphides, especially those of iron, are injurious constituents, because of their ready alteration on exposure to weather-

ing, which causes disintegration and unsightly discoloration from iron oxide stain, as well as liberating H_2SO_4 which attacks calcite.

The sulphides, chalcopyrite, galena and sphalerite (zinc blende) while of no importance as rock-making constituents are important ore minerals, and since they are frequently referred to in the Chapter on Ore-Deposits, a brief general description of each one is given below.

Pyrite

Composition. — Iron disulphide, FeS_2 , containing when pure, sulphur 53.4, iron 46.6.

Form. — Pyrite crystallizes in the isometric system, the most common form being the cube, the faces of which are usually striated (Fig. 43); also as the octahedron and pentagonal dodecahedron (Fig.

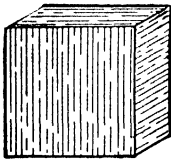

FIG. 43.

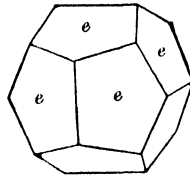

FIG. 44.

44), known as the pyritohedron. Combinations of these forms are also quite common (Figs. 45 and 46). It manifests a marked tendency to develop as crystals in rocks, but also occurs in shapeless grains and masses.

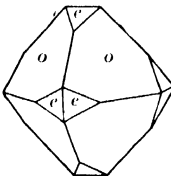

FIG. 45.

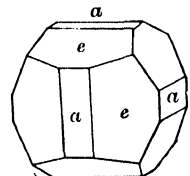

FIG. 46.

General properties. — Pyrite has no cleavage. Fracture conchoidal to uneven. Hardness 6–6.5. Specific gravity 4.95–5.10. Color brass-yellow, becoming darker on account of tarnishing. Luster metallic, splendent. Streak greenish- to brownish-black. Opaque.

Chemical tests. — Easily fusible before the blowpipe to a magnetic globule, giving off sulphur dioxide gas. Yields sulphur in closed glass tube. Insoluble in hydrochloric acid, but soluble in boiling nitric acid with separation of sulphur.

Alteration. — Pyrite alters readily on exposure to weather to iron oxide, especially the hydrated oxide, limonite. Hence rocks containing much of it are not suited for structural or ornamental purposes because of its ready oxidation, which serves both to disintegrate the rock and stain it with iron oxide.

Occurrence. — Pyrite is the most common of the sulphide minerals, and occurs in all kinds of rocks, igneous, metamorphic, and sedimentary. It is a common vein mineral, associated with many different minerals, frequently chalcopyrite, sphalerite, galena, etc.; and as a contact mineral with specularite, magnetite, etc.

Determination. — The crystal form, color, and hardness are usually sufficient to distinguish pyrite from other rock minerals.

Marcasite and Pyrrhotite

Two other forms of iron sulphide are *marcasite* (FeS_2) and *pyrrhotite* ($\text{Fe}_n\text{S}_{n+1}$, chiefly $\text{Fe}_{11}\text{S}_{12}$). These occur as less important rock constituents than pyrite, but decompose more readily on exposure to weathering processes, and hence are to be avoided in stones used for building and decoration. Pyrrhotite is an important ore mineral, and occurs in magmatic segregation deposits, contact zones, etc. (See Chapter on Ore-Deposits.)

Chalcopyrite

Composition. — A sulphide of copper and iron, CuFeS_2 , containing sulphur 35, copper 34.5, iron 30.5.

Form. — Chalcopyrite crystallizes in the tetragonal system. Crystals are sometimes observed, but as an ore mineral its usual occurrence is in irregular grains and masses.

General properties. — Color brass-yellow when fresh, but often tarnished from exposure to weather. Luster metallic. Streak greenish-black. Hardness 3.5. Specific gravity 4.25.

Chemical tests. — Easily fusible before the blowpipe to a magnetic globule. Yields a sublimate of sulphur in a closed tube. Readily soluble in nitric acid with the separation of sulphur.

Occurrence. — Chalcopyrite is the principal ore of copper, and occurs widely distributed in a variety of types of ore-bodies. It occurs as a vein mineral associated with other sulphides, such as pyrite, galena, sphalerite, etc.; as a magmatic segregation mineral in basic igneous rocks with pyrrhotite, as at Sudbury, Canada; as a contact mineral with magnetite or hematite, etc. Chalcopyrite may occur either as a primary or a secondary mineral (see Chapter on Ore-Deposits).

Determination. — Chalcopyrite is usually identified by the naked eye by its brass-yellow color, softness, and greenish-black streak. It can frequently be distinguished from pyrite by its deeper brass color and being much softer.

Galena

Composition. — Lead sulphide, PbS , containing sulphur 13.4, lead 86.6. Frequently contains silver in sufficient quantity to make it one of the most important silver ore minerals, when it is called *argentiferous galena*.

Form. — Galena crystallizes in the isometric system, the cube being the most common form. It also occurs in cleavable and coarse or fine granular masses.

General properties. — It has perfect cubic cleavage. Color and streak lead-gray. Luster metallic. Hardness 2.5-2.75. Specific gravity 7.5.

Chemical tests. — It is easily fusible before the blowpipe yielding a malleable lead globule with the formation of a yellow to white coating on the charcoal. Soluble in acids.

Alteration. — Galena may be converted by oxidation into the sulphate (*anglesite*), the carbonate (*cerussite*), or other compounds.

Occurrence. — As an ore mineral galena may have a variety of occurrences, namely, (1) in veins associated with other sulphides, such as sphalerite, pyrite, chalcopyrite, etc.; (2) as irregular masses in metamorphic rocks; (3) as irregular masses or disseminations formed by replacement or impregnation in limestones, etc.; (4) as a contact metamorphic mineral, etc. In its various occurrences galena is often associated with sphalerite, and both are *persistent* minerals, since they are formed under a variety of physical conditions.

Determination. — Its high specific gravity, cubic cleavage, color, and softness usually serve to distinguish galena from other minerals which it may resemble.

Sphalerite

Composition. — Sphalerite, known also as blende, black jack, etc., is zinc sulphide, ZnS , containing sulphur 33, and zinc 67. It usually contains some iron replacing the zinc, and frequently a small amount of cadmium.

Form. — It crystallizes in the isometric system, the tetrahedron, dodecahedron, and cube being the common forms. As an ore mineral it usually occurs in cleavable masses, coarse to fine granular.

General properties. — Sphalerite has perfect dodecahedral cleavage at angles of 60 and 90 degrees. Color varies from white to black depending upon composition, but commonly yellow, brown and reddish-brown to black. Luster resinous, also adamantine. Streak white to yellow and brown. Transparent to translucent. Hardness 3.5–4. Specific gravity 4.0.

Chemical tests. — Sphalerite is difficultly fusible before the blowpipe, yielding a white coating on charcoal when cold, yellow when hot. Intensely heated on coal with cobalt nitrate solution gives a green color. Soluble in hydrochloric acid with the evolution of hydrogen sulphide.

Occurrence. — Sphalerite is a very common mineral and is the chief ore mineral of zinc, the Joplin district, Missouri, being the most important locality in the United States. It is associated usually with other sulphides, especially galena, pyrite, marcasite and sometimes chalcopyrite. It occurs under a variety of conditions, the principal ones of which are mentioned under galena (p. 43). It may be either a primary or a secondary mineral (see Chapter on Ore-Deposits).

References on Rock-forming Minerals

1. Dana, E. S., *A System of Mineralogy*, 1900, 6th edition, 1134 pp. Wiley & Sons, New York.
2. Dana, E. S., *A Text-book of Mineralogy*, 3rd edition, revised and enlarged by Wm. E. Ford, 1922. Wiley & Sons, New York.
3. Ford, W. E., *Dana's Manual of Mineralogy*, 1912, 460 pp. Wiley & Sons, New York.
4. Bayley, W. S., *Descriptive Mineralogy*, 1917. D. Appleton & Co., New York.
5. Kraus, E. H., and Hunt, W. F., *Mineralogy: An Introduction to the Study of Minerals and Crystals*, 1920. McGraw-Hill Book Co., New York.
6. Moses, A. J., and Parsons, C. L., *Elements of Mineralogy, Crystallography and Blowpipe Analysis*, 1909, 4th edition, 444 pp. D. Van Nostrand Co., New York.
7. Phillips, A. H., *Mineralogy: An Introduction to the Theoretical and Practical Study of Minerals*, 1912, 699 pp. The Macmillan Co., New York.
8. Pirsson, L. V., *Rocks and Rock Minerals, A Manual of the Elements of Petrology without the Use of the Microscope*, 1908, 414 pp. Wiley & Sons, New York.

9. Rogers, A. F., Introduction to the Study of Minerals and Rocks, 1921, 2nd edition. McGraw-Hill Book Co., New York.

For weathering of minerals see:

10. Merrill, G. P., Rocks, Rock-weathering and Soils, new edition, 1906. The Macmillan Co., New York.

For use of minerals in deposits see:

11. Merrill, G. P., The Nonmetallic Minerals, 1910, 2nd edition. Wiley & Sons, New York.

12. Ries, H., Economic Geology, 1930, 6th edition. Wiley & Sons, New York.

For optical properties of minerals see:

13. Iddings, J. P., Rock Minerals, Their Chemical and Physical Characters, and Their Determination in Thin Sections, 1906. Wiley & Sons, New York.

14. Winchell, N. H. and A. N., Elements of Optical Mineralogy, 1909. D. Van Nostrand Co., New York. Part I. Principles and Methods, 2nd edition, 1922. Wiley & Sons, New York.

15. Johannsen, A., Key for the Determination of Rock-forming Minerals in Thin Section, 1908, illus. Wiley & Sons, New York.

CHAPTER II

ROCKS, THEIR GENERAL CHARACTERS, MODE OF OCCURRENCE, AND ORIGIN

Introduction. — Knowledge of rocks — kinds, their mineral composition and general properties, structures and textures, mode of occurrence, etc., — especially the important and more commonly occurring varieties of igneous, sedimentary, and metamorphic ones, is of fundamental importance to the engineer. Among the more important reasons why the engineer should possess a good knowledge of the different kinds of rocks may be mentioned the following: (1) Rocks differ greatly in their value for building purposes; (2) they vary markedly in their weathering qualities — resistance to atmospheric agents; (3) they vary in hardness, which materially affects the rate of drilling them and necessarily the cost; (4) they differ widely in structure, a factor which has to be considered in connection with tunneling, quarrying operations, stability of rock cuts, dam foundations, reservoir sites, value for the various uses to which they are put, etc.

Definition of a rock. — Broadly speaking, a rock in the geological sense is the material that forms an essential part of the earth's solid crust, and includes loose incoherent masses, such as a bed of sand, gravel, clay, or volcanic ash, as well as the very firm, hard, and solid masses of granite, sandstone, limestone, etc. Most rocks are aggregates of one or more minerals, but some are composed entirely of glassy matter, or of a mixture of glass and minerals. When consisting entirely of mineral aggregates, a rock may be *simple* if composed of a single mineral, such as pure marble made up of calcite, or pure quartzite of quartz; or *compound* if composed of several minerals, such as common granite which is made up of a mixture of grains of feldspar, quartz, and mica.

Many common rock names are loosely used, and this often leads to trouble. In letting contracts for quarrying, tunneling, etc., the contractor may often base his estimates on the nature of the rock to be removed, and neglect on the part of either party to properly identify or designate the kind of material to be taken out has not infrequently led to serious misunderstanding and disagreement, inconvenient as well as expensive to one party or the other.

The common minerals which enter into the composition of rocks have been treated at length in Chapter I.

In the study of rocks the following essential features should be considered before describing the individual types under each of the three main divisions named below: (1) Mode of occurrence or geological relations; (2) composition or character of the component minerals; (3) texture or manner of aggregation of the component minerals; and (4) structure or mode of arrangement. These subjects are treated in the following pages of this chapter, and in every case the practical bearing is pointed out so far as is possible.

Varieties of rocks. — Many principles have been made the bases of various schemes for grouping or classifying rocks, among the more important of which may be mentioned: (a) texture and structure; (b) mineralogical composition; (c) chemical composition; (d) geological age; (e) origin or genesis; or a combination of several of these. A discussion of these is not only unnecessary but beyond the scope of this book.

Based on the principle of genesis or mode of origin rocks may be grouped into three large classes, now recognized quite generally by all geologists. These are:

(I) *Igneous rocks*, those which have solidified from molten material.

(II) *Sedimentary rocks* (also called *stratified rocks*), those which have been laid down chiefly under water (*aqueous*) by mechanical, chemical, or organic agents. Under this division is included also a smaller group of wind-formed rocks (*æolian*).

(III) *Metamorphic rocks*, those which have been formed from original igneous or sedimentary rocks by alteration, through the action of subsequent processes (the work chiefly of pressure, heat, and water), which have resulted in wholly or partly obscuring their original characters.

These three divisions will be adopted in the following pages, each division being separately treated in the order named.

IGNEOUS ROCKS

OCCURRENCE AND ORIGIN

When fresh and unaltered the igneous rocks frequently possess certain characters by which they may be distinguished from the sedimentary and metamorphic ones.¹

¹ The igneous rocks forming the walls of some ore deposits are sometimes so altered by hot ascending solutions, that it is difficult to identify them, except by careful microscopic study. (See Chapter on Ore-Deposits.)

The evidence gained by careful study in the field as to the mode of occurrence or geologic relations of the rocks to surrounding ones whether formed as dikes, lava sheets, etc., will frequently determine the igneous origin of a rock. Again, mineral composition serves as an important distinguishing characteristic. If composed wholly or partly of glass, the rock is certainly of igneous origin; or, if made up entirely of mineral aggregates, the presence of certain minerals is usually regarded as strong evidence of igneous origin. Finally, structure and texture oftentimes furnish an important means of identification. An igneous rock usually appears homogeneous and massive, without evidence of stratification¹ and foliation or banding, structures that are common to sedimentary and metamorphic rocks, although occasionally observed in some igneous masses (for example volcanic tuffs). Amygdaloidal texture (p. 69) is characteristic of many surface lava flows. At times the igneous rock may, by its temperature or in other ways, have altered the surrounding rock near the contact in a characteristic manner. Fossils are not found in igneous rocks, except rarely in tuffs.

Mode of Occurrence

As previously stated, igneous rocks have been formed by the consolidation of molten material, the source of which was within the earth at some unknown depth beneath the surface. At times and in various localities, this molten material under proper conditions is forced upward for one cause or another towards the surface of the earth, cutting through or intruding any other kind of rock. It may be arrested at some depth below the surface where it is cooled and solidified under the influence of the surrounding rocks, or it may reach the surface and be poured out upon it, solidifying to form hard rock.

This conception leads to a two-fold division of igneous rocks. (1) Those that have solidified at considerable depths beneath the surface, designated *intrusive* or *plutonic*; and (2) those that have solidified at or on the surface, designated *extrusive* or *volcanic*. Each of these may be further subdivided.

Intrusive or Plutonic Rocks

Forms of intrusive rocks.—The principal modes of occurrence of intrusive igneous rocks recognized by geologists are as follows: *Dikes*, *sheets*, *laccoliths*, *necks*, *stocks*, and *batholiths*.

¹ Occasionally regular horizontal jointing is mistaken for stratification by persons having but slight geological knowledge.

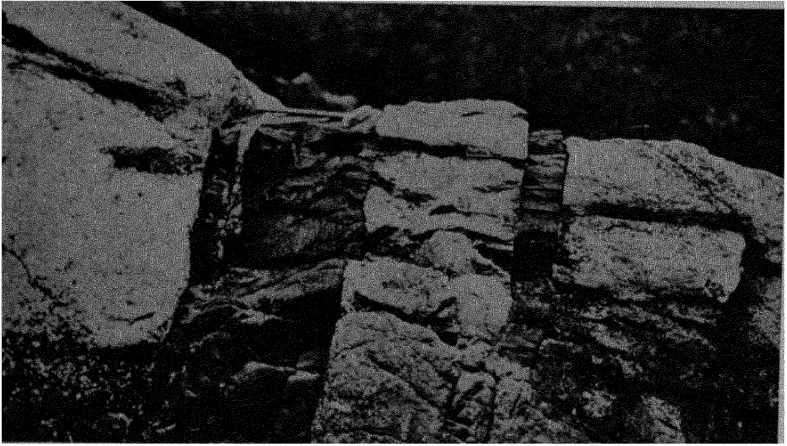

PLATE I, FIG. 1. — Parallel dikes of diabase cutting pegmatite dike, near Poupore, Quebec. (H. S. Spence, photo.)

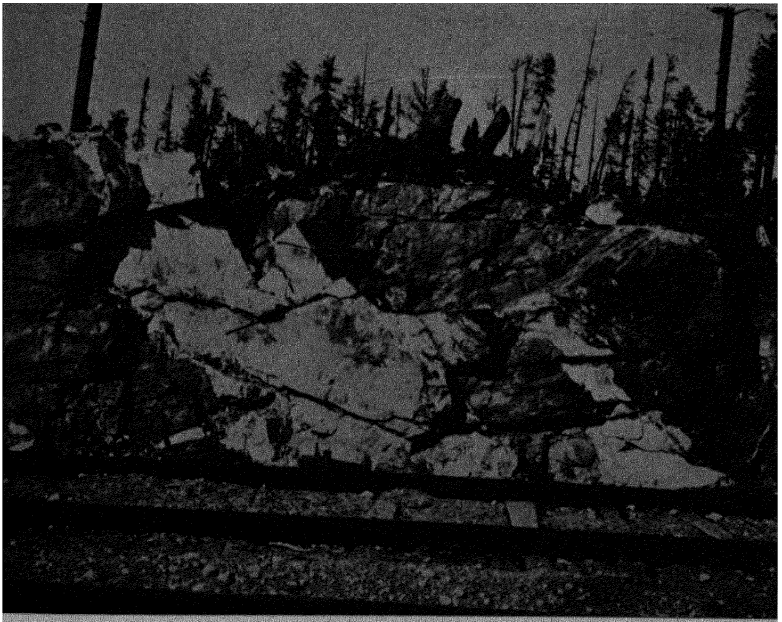

FIG. 2. — Irregular granite dikes cutting gneiss, Moose Mountain, Ont. (H. Ries, photo.)

Dikes. — A dike results from the filling of a fissure in other rocks (Plate I) by molten material from below, and there solidified. It is the simplest form of intrusion, and has great length as compared with thickness; hence, it is an elongated and relatively narrow body, which may range from a fraction of an inch in width and a few yards in length to a hundred feet and more across and miles in length. In inclination dikes may vary from vertical to horizontal, the most frequent attitude being that of vertical or nearly so.

Frequently they may be observed extending outward from larger masses of intruded rock (Fig. 52), but in many cases such a relationship is not visible. They may continue along remarkably straight lines or follow irregular or sinuous courses (Plate I, Fig. 2). A large dike may divide into two or more smaller ones which continue usually in the same general direction, and apophyses or stringers are common. The igneous rock of the dike may be acid or basic in character, and

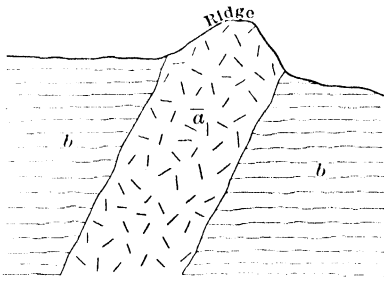

FIG. 47. — Section through dike more resistant to weathering than the inclosing rock, marking the position of a ridge. (a) dike; (b) inclosing rock.

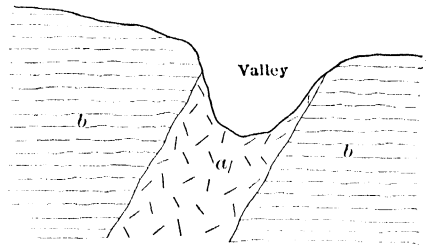

FIG. 48. — Section through dike less resistant to weathering than the inclosing rock, marking the position of a valley. (a) dike; (b) wallrock.

dikes of each are common over many parts of the eastern or Atlantic province of crystalline rocks (see plate showing granite areas in Chapter XI). The large dikes almost invariably show finer-grained texture along the margins than in the centers, whereas the narrow dikes are apt to be fine-grained throughout. Also some of the large dikes show alteration of the inclosing rocks along the contacts.

Subsequent erosion and weathering of a dike may or may not result in topographic expression (Figs. 47 to 49). Usually if the dike rock is more resistant to weathering and erosion than the inclosing rocks, the position of the dike will be marked by a ridge (Fig. 47). Sometimes the opposite effect is shown and a valley-like depression results (Fig. 48). Again, it frequently happens that no topographic expression is

shown (Fig. 49), and as in the crystalline province of the eastern United States, the only surface indication remaining to mark the position of the dike is a line of large and small boulders of the original dike scattered loose over the surface and partly buried in the resulting residual rock decay (clay) (Plate XXXI).

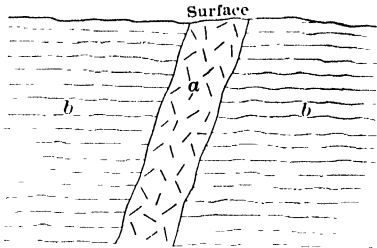

FIG. 49. — Section through dike and inclosing rock, showing no topographic expression from weathering. (a) dike; (b) inclosing rock.

erated loose over the surface and partly buried in the resulting residual rock decay (clay) (Plate XXXI).

Dikes are so abundant that the engineer frequently encounters them in the field. They are often not of any value as road or building material, because of their narrow width, and their occurrence in quarries (Plate VI, Fig. 1) is objectionable because they spoil the stone, and sometimes crack it up badly. Abundant dikes therefore may mean much

waste, unless the defective stone can be broken up for road material.

In some localities the dike rock may be weathered (but not eroded) to such an extent that it permits access of surface water. If then these decayed dikes are encountered in underground operations, the water seeping downward along them may give trouble.¹ Again, intersecting dikes may cause trouble in tunneling by the blocks between them dropping out, as was the case in the Mount Royal tunnel at Montreal, Canada.

Ore bodies sometimes but not always are associated with dikes, while at other times a dike of later age may cut across the ore deposit, a condition which has sometimes been misinterpreted, and led to the belief that the ore had given out.

Another case of error has been caused by the occurrence of somewhat broad parallel dikes, whose adjoining boundaries were hidden by surface material, leading the engineer to suspect that the two were one large dike.

Intrusive sheets. — Intrusive sheets or *sills* are solidified bodies of molten material intruded between the stratification or foliation planes of sedimentary and metamorphic rocks, and hence they assume a somewhat bedded aspect (Fig. 50). They have a relatively great lateral extent as compared with their thickness. Probably the basic and intermediate

¹ A band of clayey rock encountered underground does not always represent decayed dike rock, but is sometimes rock which has been first crushed by movement along a fracture (faulting), and subsequently weathered by percolating water.

igneous rocks, such as andesites and basalts, assume the form of intrusive sheets more frequently than the acid rocks.

Sheets may range from a foot to several hundred feet or more in thickness, and may cover an area many miles in extent. "The Pali-

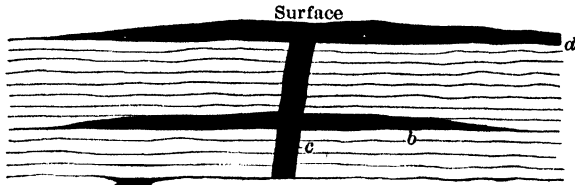

FIG. 50.—Section through (a), extrusive and (b) intrusive sheets, and (c) conduit.

sades of the Hudson are formed by a sheet of unusual thickness; its out-crop is 70 miles long from north to south, and its thickness varies from 300 to 850 feet" (Scott). Sheets sometimes break across the strata and are continued at a new horizon (Fig. 51). Frequently thick sheets

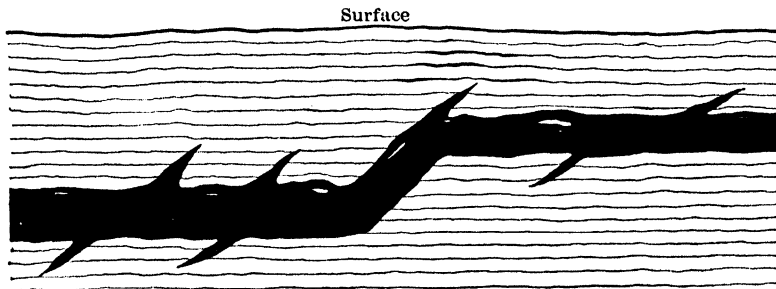

FIG. 51.—Section of intrusive sheet, breaking across the strata and continuing in the same general direction at a higher horizon; sheet shows apophyses and inclusions of country rock.

or sills divide into several subordinate ones, each following more or less closely a plane of bedding.

Intrusive sheets may sometimes be mistaken for surface lava flows that have subsequently been buried. They may often be distinguished from contemporaneous sheets or flows by (a) alteration by heat of the beds immediately above and below; (b) breaking across the beds at any point and continued along another horizon; (c) giving off of tongues or apophyses into the overlying as well as underlying beds; (d) the general absence from the upper surface of scoriaceous or tuffaceous material and of vesicular and amygdaloidal textures (which see); (e) incorporation of rock fragments in the sheet torn from the overlying bed, etc.

Sheets or sills do not always show the same mineral composition from top to bottom (see magmatic differentiation, p. 70). Where such variation exists the rock may be dark-colored or basic at the bottom and lighter-colored and siliceous at the top, affording two different types of building stone. Such a difference exists in the sill of Sudbury, Ontario, where the nickel-copper ores are found only in the basic or lower portion of the sill. Sheets or sills are not of much importance as a source of building stone.

Laccoliths.—A laccolith is a lenticular or dome-shaped mass of igneous rock intruded between strata. It may be considered as a special case of an intrusive sheet in which the supply of molten material from below exceeds the rate of lateral spreading, and is accompanied by arching of the overlying beds at the surface. A section through the igneous mass usually shows a flat base and a convex upper surface (Fig. 52), resembling a half lens. Figs. 52 and 53 show variations in

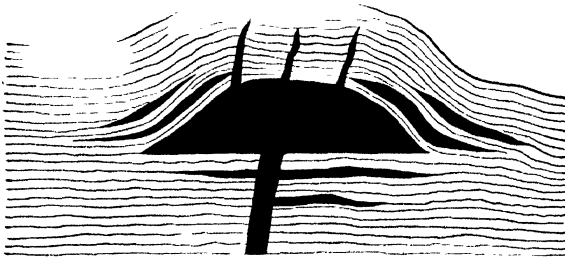

FIG. 52. — Section through laccolith showing associated sheets and dikes. Compare outline of laccolith with that of Fig. 53.

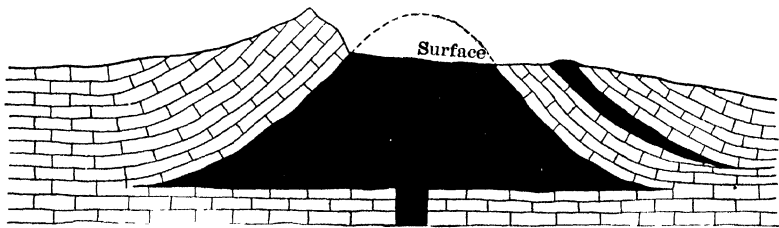

FIG. 53. — Section through partly eroded laccolith showing different outline from Fig. 52.

the general structure of laccoliths due probably, as has been suggested by some, to progressive increase of viscosity of the magma during its intrusion. In plan the mass approximates a circle, but may be somewhat elongated and oval-shaped, and in size (thickness and lateral extent) is subject to great variation. In some cases the laccolith is accompanied by intrusive sheets and dikes (Fig. 52), and like the

latter they may and do frequently alter by metamorphism the overlying and underlying beds. The pressure of the intruded magma forming the laccolith usually causes a lifting of the overlying strata and produces a dome-like elevation at the surface (Fig. 52). Laccoliths may occur singly, though they often occur in groups, a dozen or more being clustered together in some instances.

The Henry Mountains of Utah, first described by G. K. Gilbert, form a typical representative of the laccolithic method of intrusion. Here, many stages of erosion are represented and may be observed. Many other examples of laccoliths are known in the western United States and in Europe.

Laccoliths, like sills, may sometimes show a zonal structure, and hence the center and margins might supply different kinds of rock.

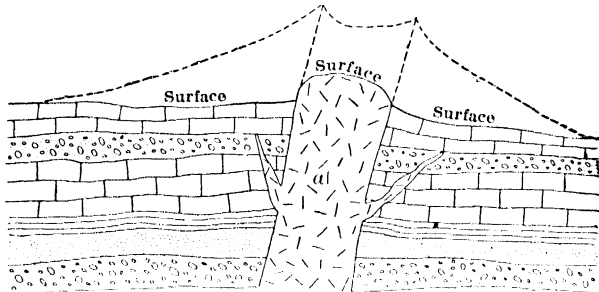

FIG. 54. — Section through volcanic neck or plug (a), volcanic cone shown by dotted lines, removed by erosion. }

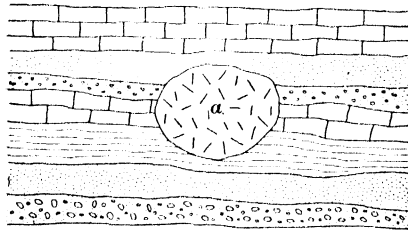

FIG. 55. — Plan of volcanic neck or plug (a).

Necks. — These are roughly cylindrical masses of igneous rock having probably great but unknown depth, which fill the vents or conduits of volcanoes. Erosion may remove practically all trace of the surrounding beds of more porous and softer volcanic ejectments, leaving the plug of resistant, consolidated igneous rock as a more or less conspicuous topographic form (Fig. 54). Volcanic necks may range up to a mile or more across, and are usually more or less circular in plan (Fig. 55). Good examples of necks are noted in places over the

western half of the United States, especially those of western New Mexico.

Stocks. — Stocks, known also as *bosses*, are irregular, rounded masses of igneous rock intruded and solidified at some depth beneath

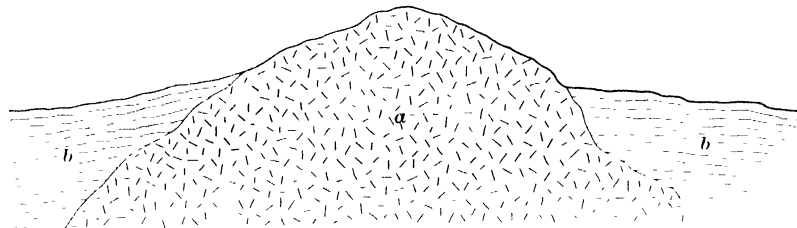

FIG. 56. — Section through stock or boss. (a) granite boss; (b) inclosing rock.

the surface, and now exposed from stripping by erosion of the thickness of overlying rocks (Fig. 56 and Plate XXXIII, Fig. 2).

Stocks may range in size from a few hundred feet to several miles; and in plan they may vary from more or less circular to elliptical in outline (Fig. 57). They may cut across the inclosing (country) rock

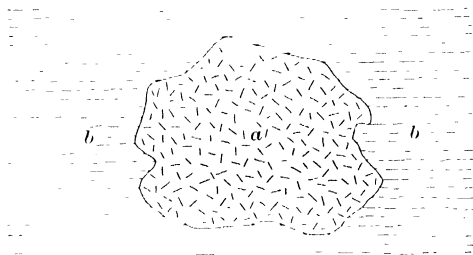

FIG. 57. — Plan of stock or boss. (a) granite; (b) inclosing rock.

with frequently steeply-inclined contacts, along which characteristic metamorphism is often observed.

Because the rock, especially granite, composing stocks or bosses is frequently of more resistant character than the surrounding or country rock, they become dome-like masses of steep or gentle slopes, and oftentimes on account of size are conspicuous topographic forms (Plate XXXIII, Figure 2). Many of them show an elevation of several hundred feet, and in extreme cases 700 or 800 feet and more above the surface of the surrounding rocks, such as Stone Mountain, Georgia, and the splendid granite domes of the Yosemite in California. On the other hand in regions of old land surfaces which have been continuously

exposed to weathering and erosion for very long periods of time, the surface of the boss shows no topographic expression, but is more or less flat and coincident with that of the inclosing rocks.

Batholiths. — These are huge masses of plutonic rock hundreds of miles in extent which are now exposed at the surface by erosion (Fig. 58). They are similar to stocks, but differ from them mainly in their much larger size, the small batholith and the large stock grading into each other. If they could be followed down, probably many stocks would prove to be protrusions from batholiths (Fig. 58). Batholiths are shown in the oldest regions of the earth, such as eastern Canada, etc., or forming the core of many mountain ranges, like the Sierra Nevada and Rocky Mountains. They usually consist of some granitoid rock, such as granite, syenite, diorite, etc., but probably granite is the commonest rock forming them. The country rock surrounding them is also variable.

Both batholiths and stocks are important sources of granitic rock for use in structural work. The massive character of the rock, and the arrangement and spacing of the joints make the material well adapted for the extraction of dimension blocks.

In the West important ore bodies are sometimes found along the borders of such batholiths.

Extrusive or Volcanic Rocks

These may be (a) molten material poured out onto the surface from a volcanic vent or along a fissure and solidified, or (b) fragmental material (*pyroclastic*) of all sizes erupted from volcanic vents. The first forms surface *lava flows* and *sheets*, the second *ash-beds* (Plate VI, Fig. 2), and coarser fragmental material, which on consolidation yield beds of *tuffs* and

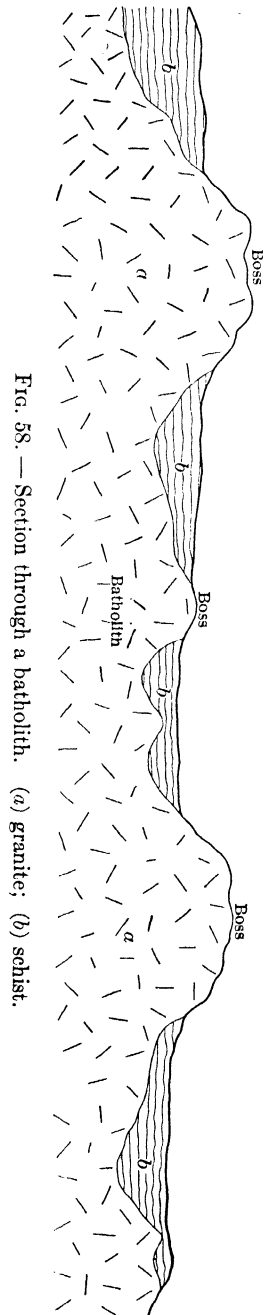

FIG. 58. — Section through a batholith. (a) granite; (b) schist.

volcanic *breccias*. The crystalline (lava flows) and fragmental materials frequently occur interstratified as shown in Fig. 59. The fragmental materials show all varieties of texture and structure, some being very fine-grained while others are very coarse, but bedding is usually pronounced.

Lava flows and sheets. — These are formed on the surface from quiet outwellings of highly molten material through (a) a localized opening or volcanic vent and hence connected with volcanic eruptions, or (b) from fissures not connected with volcanic eruptions. The lava flow may be either *subaerial* (on land) or *submarine*, according to whether the eruption takes place on land or on the sea bottom. The flows vary much in thickness, some being only a few feet while others are measured in yards.

Subaerial flows from volcanic vents may build cones having very low angles of slope and of great lateral extent, according to the fluidity of the lava erupted, such as the volcanic cones of Hawaii and Iceland. Thus the more basic lavas are the more fluid. These may alternate

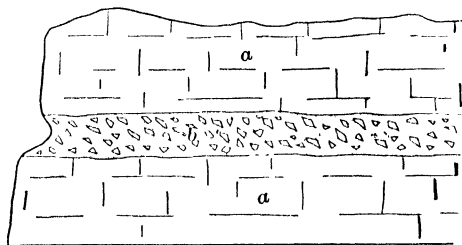

FIG. 59. — Section through a series of interbedded lava flows, and fragmental materials. (a) lava flows; (b) fragmental materials.

with extrusions of fragmental material (Fig. 59), when a cone of composite character and steeper slopes is formed (Plate II, Fig. 1).

In many places over the earth's surface lava flows have resulted from the quiet outpouring onto the surface through fissures, spreading in some cases hundreds of miles in extent and several thousand feet in thickness. Such *fissure-eruptions* have occurred on a gigantic scale in the Columbia River region of the northwestern United States, in eastern India, in the north of the British Isles, and in historic times in Iceland.

In some cases surface lava sheets have later become buried by deposition of other rocks on them through depression below sea-level. In such cases the buried sheet resembles one of intrusion, but can usually be distinguished from the latter by absence of metamorphism of the overlying beds, and the structures characteristic of the surface of lavas, such as scoriaceous, amygdaloidal, vesicular, etc.



PLATE II, FIG. 1. — Volcanic cone of Colima, Mexico. Built up of ash and lava flows. Parasitic cone of 1865 on left. Ridge in foreground part of base of original cone destroyed by an explosive eruption. (H. Ries, photo.)

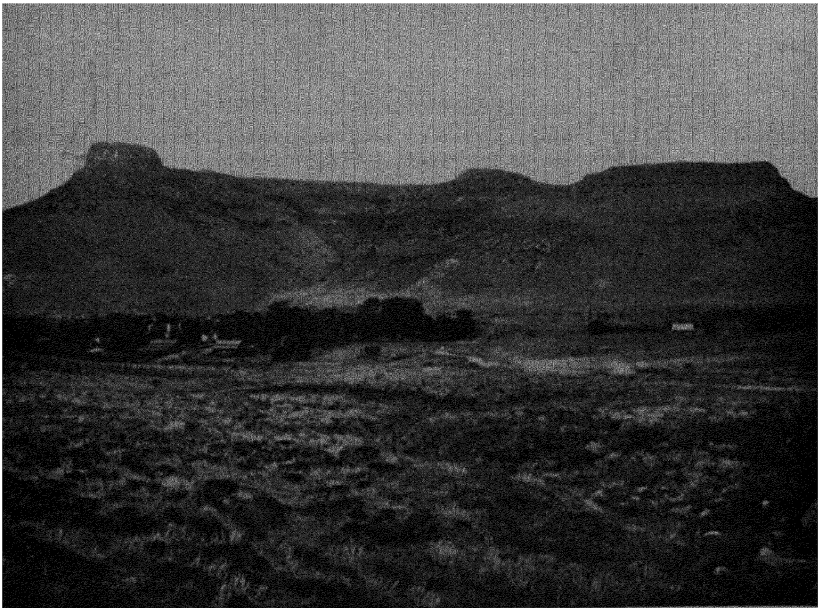

FIG. 2. — Table Mountain, Golden, Colo. Capped by several flows of resistant basalt. Under these are beds of sedimentary rocks. (H. Ries, photo.)

The fragmental (pyroclastic) materials are those which have been thrown out with great force and in enormous volume, during violent volcanic eruptions. They have settled down over the surrounding country, either on land (Plate VI, Fig. 2) or in water, and hence often show a stratified structure.

In the western states and Mexico, where these volcanic rocks are abundant the engineer has to deal with them.

Lava flows, though often thick, are sometimes shallow, and overlie stream gravel or other deposits (Plate XLI, Fig. 1). When testing a rock foundation for dams, reservoirs or other structures, which are to be placed on lava flows, care should be taken to see that the lava cap is sufficiently thick to give a solid and impermeable base.¹

Lava flows are not as a rule adapted to the production of large blocks. Many show a columnar jointing (Plate III, Fig. 2). The stone at the surface of the flow may be broken up (Plate III, Fig. 1), or if massive is often full of gas cavities, which may be absent deeper down (Plate III, Fig. 2).

The more porous and softer volcanic rocks, like tuffs and agglomerates, can often be cut into larger blocks than the consolidated lavas. They are however usually very porous, and should not if possible be used in moist situations. Curiously enough however many of these very porous volcanic rocks are not injured by frost, probably because they do not absorb enough water to completely fill their pores. (See absorption under Building Stones.)

The high porosity of tuffs and breccias may also cause trouble in dam and reservoir construction, because they permit seepage under the walls, so that the bed rock may have to be filled with grout, or sealed up in other ways. In the case of one dam foundation on the Clackamas River in Oregon, grout forced down a 50-foot pipe under a 200 pounds pressure, crossed a six-foot interval in the volcanic breccia, rushed up another pipe to the surface and spurted 30 feet into the air. For similar reasons a tunnel driven through them should be lined.

The use of volcanic ash for hydraulic cement is referred to in Chapter XII.

Composition of Igneous Rocks

Under this heading is discussed (a) *chemical* and (b) *mineralogical* composition of igneous rocks. As previously stated, most igneous rocks are made up of mineral aggregates. For such rocks mineral composition is dependent in large measure on chemical composition of the

¹ For example see case of Zuni Dam, *Eng. News*, LXIV, p. 203, 1909.

rock magmas.¹ When solidified under different physical conditions, rock magmas having similar chemical composition may yield different minerals; and differences in chemical composition usually result in variations in mineral composition. Chemical composition plays a fundamental role in the classification of igneous rocks, as discussed later.

Chemical composition. — It is obvious that rock magmas as such cannot be subjected to chemical analysis, but their solidified products (rocks) can; and from the very large number of analyses made of igneous rocks from all parts of the world, they are shown to be, without exception, silicate magmas. The many hundreds of analyses that have been made of igneous rocks invariably show that they contain the following principal oxides: *Silica* (SiO_2); *alumina* (Al_2O_3); iron oxides, *ferric* (Fe_2O_3) and *ferrous* (FeO); *magnesia* (MgO); *lime* (CaO); *soda* (Na_2O); and *potash* (K_2O). Other lesser oxides, including water, are present, but no account is taken of them here, since they usually occur in such small amounts that they do not exert any important influence on the rock.

Igneous rocks show varying chemical composition, which is used by the geologist to study their relationships, but to the engineer chemical analysis is not of much practical value. Igneous rocks form a series ranging from acid ones (high in silica), with dominant alkali feldspar and quartz, to basic ones (low in silica) with ferromagnesian silicate minerals predominating.

Since the acid magmas contain silica in excess of the bases, these will develop free quartz in the rocks crystallized from them. The total percentage of silica in them may reach 80 per cent. On the other hand, many magmas are low in silica, as shown in the analyses of the rocks formed from them. In the basic rocks the percentage of silica may be as low as 40 per cent, and in some ultrabasic ones it may be even lower, not exceeding 30 per cent. The amount of silica present exercises an important influence on the crystallization of the magma, as discussed later.

The eight principal oxides enumerated above as composing igneous rocks do not exist as free oxides except in a few cases and with but few exceptions only in small amounts. Of these the iron oxides are the most frequently occurring ones, although alumina as the mineral corundum is sometimes present. With these exceptions, the oxides of aluminum, iron, magnesium, calcium, sodium, and potassium are combined in the form of silicate minerals, which, with rare exceptions, compose the igneous rocks.

Alumina may range from nothing in some of the nonfeldspathic rocks, such as the peridotites, to 20 per cent and more in some syenites. It is present chiefly in

¹ Magma is now generally employed for the molten masses of igneous rock before they have crystallized. An original parent magma may break up into several derived ones. J. F. Kemp, *Handbook of Rocks*, 1906, p. 202.



PLATE III, FIG. 1. — End of an α -a flow of lava, Colima, Mex. (H. Ries, photo.)

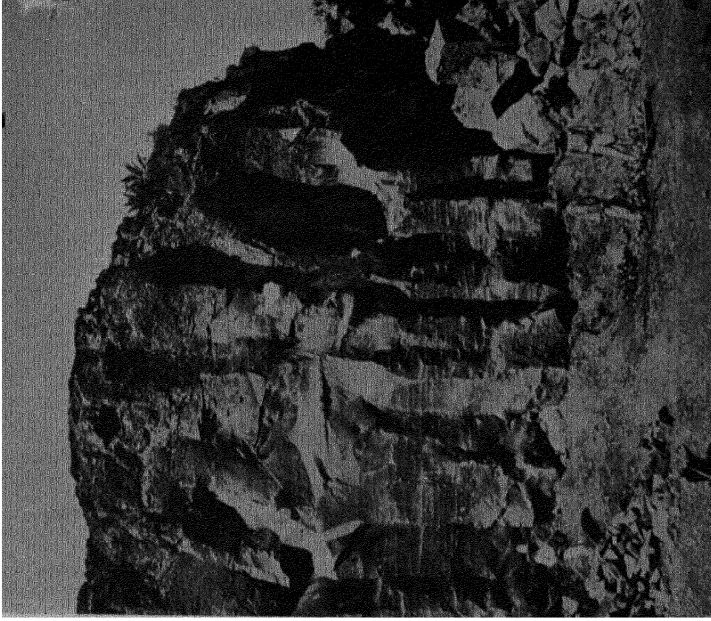

FIG. 2. — Basalt lava, near Mexico City, Mex.; shows rudely columnar jointing, and gas cavities in upper portion. Quarried for paving blocks. (H. Ries, photo.)

rocks in combination with silica and the alkalis, and in some cases lime, as feldspars and feldspathoids. It also enters into the composition of some of the so-called ferromagnesian minerals, such as mica, hornblende, augite, etc. As noted above, alumina is sometimes present in rocks as the mineral corundum.

The oxides of iron and magnesium combine with silica to form the so-called ferromagnesian minerals, which comprise the pyroxene, hornblende, biotite, and olivine groups as the principal rock-forming ones (see Chapter I). Lime enters into combination with the same bases and silica in the monoclinic pyroxenes and amphiboles, and is an important constituent in the more calcic (basic) plagioclase feldspars. It is essentially absent from the orthorhombic pyroxenes and biotite.

The ferromagnesian minerals are usually present in only subordinate amounts in the acid rocks, but increase in quantity and are the predominant minerals in the basic rocks.

The alkalis, potash and soda, in combination with alumina, silica, and in some cases lime, are of fundamental importance in the feldspars (orthoclase and plagioclase groups), and the feldspathoids. They are, especially soda, important constituents in the alkali-rich pyroxenes and amphiboles; and potash enters into the composition of biotite.

Phosphoric anhydride (P_2O_5) and titania (TiO_2) among the lesser oxides are quite generally present in igneous rocks; the former in combination with lime as the mineral apatite is of most importance in the basic rocks; while the latter occurs as free oxides in the minerals ilmenite and sometimes rutile, as the lime titanosilicate sphene, the lime titanate perovskite, and in variable but small quantities in the ferromagnesian silicates.

Boron, fluorine, and chlorine frequently occur in minute quantities in igneous rocks; as do also sulphur and carbon, the former as sulphides, especially as the mineral pyrite, and the latter in elementary form as graphite.

The annexed table will serve in some measure to give a general idea of the composition of the principal types of plutonic igneous rocks. Analyses of the corresponding volcanic rocks are omitted from the table, since they have similar composition to their equivalent plutonic types.

TABLE OF ANALYSES OF PLUTONIC IGNEOUS ROCKS

	I.	II.	III.	IV.	V.	VI.	VII.	VIII.
SiO ₂	72.27	65.43	60.39	70.36	62.71	46.85	45.05	33.84
Al ₂ O ₃	14.30	16.11	22.57	15.47	17.06	19.72	6.50	5.88
Fe ₂ O ₃	1.16	1.15	0.42	0.98	3.79	3.22	3.83	7.04
FeO.....	0.97	2.85	2.26	1.17	2.74	7.99	7.69	5.16
MgO.....	0.70	0.40	0.13	0.87	1.78	7.75	12.07	22.96
CaO.....	1.56	1.49	0.32	3.18	5.51	13.10	18.82	9.46
Na ₂ O.....	3.46	5.00	8.44	4.91	3.54	0.09	0.94	0.33
K ₂ O.....	5.00	5.49	4.77	1.71	2.96	1.56	0.78	2.04
Rest.....	0.83	2.26	0.65	1.43	0.14	0.56	5.20	13.83
	100.25	100.18	99.95	100.08	100.33	100.84	100.88	100.54

I. Biotite granite, near Richmond, Virginia; II. Syenite, Mount Ascutney, Vermont; III. Nepheline syenite (Litchfieldite), Litchfield County, Maine; IV. Quartz diorite, near Enterprise, Butte County, California; V. Diorite, Bush Creek, Elk Mountains, Colorado; VI. Gabbro, Baltimore, Maryland; Average of 23 samples; VII. Pyroxenite, Brandberget, Norway; VIII. Peridotite, Crittenden County, Kentucky.

Study of this table of analyses of the principal types of plutonic igneous rocks discloses wide variations in the eight chief component oxides. Silica, alumina, and the alkalis (soda and potash) are the principal components in the most acid rock granite, which indicates that feldspar and quartz are the dominant minerals. As the basic and ultrabasic types are approached, these oxides decrease in quantity and the oxides of iron, magnesium, and calcium increase, which, when expressed mineralogically, emphasizes the increase of ferromagnesian minerals with decrease of quartz and feldspar; the former being quite generally absent and the latter (feldspar) failing entirely in the ultrabasic rocks.

F. W. Clarke has calculated the average composition of igneous rocks, based on the most reliable data available, to be as follows:

TABLE SHOWING AVERAGE COMPOSITION OF IGNEOUS ROCKS
(Reduced to 100 per cent)

SiO ₂	59.83
Al ₂ O ₃	15.02
Fe ₂ O ₃	2.62
FeO	3.43
MgO	3.74
CaO	4.83
Na ₂ O	3.37
K ₂ O	3.05
H ₂ O	1.90
Rest	2.21
	100.00

Under "rest" in the table above is included TiO₂, ZrO₂, CO₂, P₂O₅, S, Cl, F, BaO, SrO, MnO, NiO, Cr₂O₃, V₂O₅, and Li₂O.

Mineral Composition. — Most igneous rocks are aggregates of minerals; a few are composed wholly of glass, and still others are made up of a mixture of minerals and glass. Given magmas of similar chemical composition and vary the physical conditions of cooling on solidifying, development of different minerals will result.

The mineral composition affects the hardness, durability, beauty, and ability of the rock to take a polish.

From the discussion under "chemical composition" it has been shown that the principal oxides found on analysis are combined with each other to form silicate minerals, the chief components of igneous rocks. The important groups of these include feldspars, quartz, and the ferromagnesian minerals. For convenience of classification the more important minerals of igneous rocks may be tabulated under two groups as follows:

Siliceous-aluminous Group (Salic).	Ferromagnesian Group (Femic).
Alkalie feldspar	Pyroxenes
Plagioclase feldspar	Amphiboles
Quartz	Biotite
Nephelite	Olivine
Sodalite	Iron ores
Corundum	

Considered mineralogically, the acid rocks are characterized by the presence or dominant alkali feldspar and more or less quartz, with subordinate ferromagnesian minerals. They are rich in silica, alumina, and alkalies, but contain only small amounts of iron, lime, and magnesia, hence these rocks are usually light in color, have a low density or specific gravity (average about 2.6), and comparatively high fusion point.

Intermediate rocks contain little or no quartz, but consist chiefly of alkalic and soda-lime feldspars, with in some cases the feldspathoids (nephelite, sodalite, etc.), with or without ferromagnesian minerals.

In the basic igneous rocks ferromagnesian minerals predominate; the dominant feldspar is a member of the lime-soda series, quartz is absent, and olivine is frequently present. They contain less silica and alkalies than the acid rocks, but are higher in iron, lime, and magnesia. The rocks are, therefore, much more fusible, are dark in color, and have a relatively high density or specific gravity, being about 3.0 to 3.2, reaching in the ultra-basic rocks as much as 3.6.

In the ultrabasic rocks, both feldspar and quartz are essentially absent, and one or more of the ferromagnesian minerals is the dominant component, either hornblende, a pyroxene, olivine, or a mixture of these.

According to F. W. Clarke,¹ "a statistical examination of about 700 igneous rocks, which have been described petrographically, leads to the following rough estimate of their mean mineralogical composition:"

Quartz	12.0
Feldspars	59.5
Hornblende and pyroxene	16.8
Mica	3.8
Accessory minerals	7.9
	100.0

Grouping of minerals. — A convenient and useful division of the rock-forming minerals which enter into the composition of igneous rocks is into (a) *essential* and (b) *accessory*. Essential minerals influence greatly the character of a rock and their presence is therefore necessary for the naming of it. For example, quartz with certain other minerals is essential to the naming of a rock granite, but if quartz be practically absent or present in only very small amount the rock composed of the same mineral aggregates would be designated a quartzless granite or syenite.

On the other hand, accessory minerals occur only sparingly or in small quantity and their presence or absence does not materially affect the nature of the rock. Thus, quartz and feldspar are essential minerals in granite, while zircon and apatite are accessory.

Another important distinction that is frequently made between minerals of igneous rocks is whether they are *original* or *secondary*. Original minerals, known also as pyrogenetic or primary, have formed

¹ The Data of Geochemistry, U. S. Geol. Survey, Bull. 695, p. 32, 1920.

from the solidification of the magma, while *secondary* minerals have formed subsequent to the crystallization of the magma, and from the original ones by alteration (weathering, contact or dynamic metamorphism, etc.). Thus kaolinite, sericite, talc, calcite, and epidote are secondary minerals in igneous rocks.

Essential minerals are original, but not all original minerals are essential. For example, quartz and feldspar in granite are both essential and original minerals, while zircon and apatite in the same rock are original, but they are not essential minerals. An essential mineral may sometimes be replaced by a secondary one, such as hornblende (uralite) which replaces pyroxene in gabbros that have been subjected to metamorphism.

Order of crystallization. — The order in which minerals crystallize from a magma is indicated by the mutual relations of the components as viewed in thin sections under the microscope, or, as in the case of coarse-grained rocks, from polished surfaces. Thus far experience shows that minerals crystallizing from magmas do so not simultaneously but successively, with in some cases overlapping of their periods of crystallization, as shown in quartz and feldspar, from the study of thin sections of granite.

Rosenbusch states that in general the order of crystallization of minerals from magmas is in four groups as follows:

I. Iron ores and accessory constituents (magnetite, hematite, ilmenite, apatite, zircon, spinel, sphene, etc.).

II. Ferromagnesian silicates (olivine, pyroxene, amphibole, mica, etc.).

III. Feldspathic constituents (feldspars and feldspathoids, including leucite, nephelite, sodalite, etc.).

IV. Free silica (quartz).

This order of crystallization applies especially to nonporphyritic rocks. "More explicitly," as Harker¹ states, "what is regarded as the normal sequence is laid down in the following rules:"

I. "The separation of crystals in a silicate-magma follows an *order of decreasing basicity*, so that at every stage the residual magma is more acid than the aggregate of the compound already crystallized out."

II. "The relative amounts of the several constituents present in the magma affect the order of crystallization in such a manner that, in general, those present in smaller amount crystallize out first."

III. "Having regard to the several bases represented in the various constituents crystallization begins with the separation of iron oxides and spinellids, proceeds with the formation of magnesium and iron silicates, then silicates of calcium, then those of the alkali metals, and ends with the crystallization of the remaining free silica."

Mineralizers. — Study of extrusive lavas at the time of expulsion shows the presence of considerable quantities of volatile substances, chief among which is water vapor. Besides water vapor there are

¹ The Natural History of Igneous Rocks, 1909, pp. 180-181.

carbon dioxide, fluorine, chlorine, boric acid, sulphur, etc. These dissolved vapors, known as *mineralizers*, for the reason that they exercise an important influence on mineral composition and to some extent texture, are regarded as being more generally present in acid than in basic magmas, although known to occur in both. These substances play an important role in the crystallization of igneous rocks, and their action in the production of minerals from solidifying magmas may be either chemical or physical.

For the formation of certain minerals, such as hornblende, biotite, tourmaline, etc., which contain small quantities of water as hydroxyl (OH), fluorine, and boric acid, the presence of mineralizers in the magma is essential, and their function is a chemical one. On the other hand, many minerals cannot be produced by dry fusion, but require for their production the presence of certain mineralizers, especially water vapor, which acts physically in lowering the melting point of the fusion and increasing its fluidity, as in the formation of orthoclase, albite, and quartz.

Texture of Igneous Rocks

By *texture* of an igneous rock is meant size, shape, and manner of aggregation of its component minerals. It serves an important means of determining the physical condition under which the rock was formed, whether at or near the surface, or at some depth below, and hence is recognized as one of the important factors in the classification of igneous rocks.

Some rocks are sufficiently coarse-grained in texture for the principal minerals to be readily distinguished by the unaided eye; in others the minerals are so small in size as to defy identification by the naked eye or even with the aid of a pocket lens; and in still others no minerals have crystallized, but, instead, the magma has solidified as a glass. These express the physical (rate of cooling) and not the chemical conditions under which magmas have solidified, and in turn serve in a general way to express the position in the earth's crust in which this solidification took place. The rate of cooling, therefore, is one of the most prominent factors in determining rock texture. Other important factors that influence the development of rock texture are chemical composition, temperature, pressure, and the presence of mineralizers.

Kinds of texture.— Since texture expresses so closely the conditions under which rock magmas solidify, it is recognized as an important property of rocks, and is made one of the principal factors in their classification (see page 70). In the megascopic description of igneous rocks, including their pyroclastic (volcanic) equivalents, five principal textures are recognized. These are *glassy*, *dense or felsitic (aphanitic)*, *porphyritic*, *granitoid*, and *fragmental*.

Glassy texture. — Under conditions of quick chilling, magmas, especially the more siliceous ones, freeze or solidify into a glass, without distinct crystallization and the formation of visible minerals. Such rocks do not show definite minerals and are composed of glass, examples of this being obsidian, pitchstone, etc. Some glasses, such as *pumice*, are highly vesicular due to the escape of water vapor at high temperature through relief of pressure.

Dense or felsitic (aphanitic) texture. — This texture is characteristic of crystalline rocks, but the individual minerals are too small in size to be distinguished by the eye. The general appearance of the rock is homogeneous and stony but not glassy. Examples, many felsites and basalts.

Porphyritic texture. — Porphyritic texture is characteristic of those rocks composed of mineral grains or crystals of larger size set in a groundmass (Plate IV, Fig. 2) that is more finely crystalline or even glassy, or both. The larger crystals or grains are termed *phenocrysts* and may show distinct crystal outline (*idiomorphic*), or may have irregular and corroded surfaces (*alotriomorphic*). They may be very abundant in some rocks, exceeding occasionally the groundmass in amount, or they may be very scantily developed. Great variation in size is also shown, from an inch and more in diameter down to those so small that they are scarcely discernible. They may consist of the light-colored minerals (quartz and feldspar) or of the dark-colored ferromagnesian ones (hornblende, pyroxene, olivine, etc.), or of a mixture of light- and dark-colored minerals.

Porphyritic texture is frequently developed in lavas, dikes, sheets, and laccoliths, and is less often observed in the deeper-seated rocks, but by no means uncommon in some, as in granites.

In porphyritic rocks the groundmass often weathers more rapidly than the phenocrysts, leaving the latter in more or less strong relief.

Granitoid texture. — Those igneous rocks which are composed entirely of recognizable minerals of approximately the same size possess granitoid or even-granular texture. The individual minerals seldom exhibit definite crystal boundaries. Example, normal granite.

According to the size of mineral grains, we may recognize: (1) *Fine-grained* rocks, average size of particles less than one millimeter; (2) *medium-grained*, between 1 and 5 millimeters; and (3) *coarse-grained*, greater than 5 millimeters.

Other things equal, fine-grained granitoid rocks are more durable than coarse-grained ones.



PLATE IV, FIG. 1. — Banded felsite, showing flow structure.

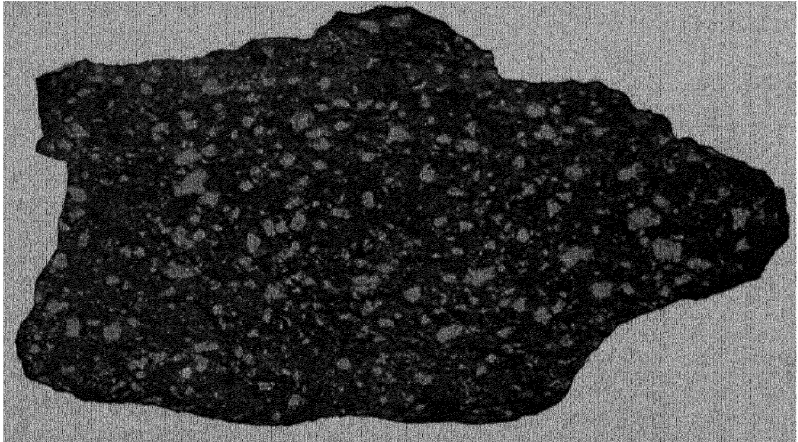

FIG. 2. — Trachyte, showing porphyritic texture.

Fragmental texture. — Fragmental is a textural term used in describing volcanic tuffs and breccias, which represent the consolidation of pyroclastic materials of all sizes erupted by volcanoes.

Porous texture. — The effusive igneous rocks, showing glassy and felsitic textures, may vary texturally from very compact and dense to very porous, with nearly all gradations between these extremes observed. According to the abundance of spacings or cavities, caused by escaping vapors from the magma during cooling, the rock may be termed *vesicular* (Plate V, Fig. 1), *scoriaceous*, or *pumiceous*.

When these cavities have been filled with mineral matter deposited from solution, the rock is described as having *amygdaloidal texture*. The fillings, which may be any one or more of a variety of minerals, usually zeolites, calcite, epidote, quartz, or feldspar, are termed *amygdules*, because of their resemblance to almond-shaped forms. Amygdaloidal texture is especially common in the surface lava flows (basalts) of all ages occurring in the United States.

During the cooling of granitoid (plutonic) rocks, irregular small cavities are sometimes developed, especially in some granites, into which the minerals project as well-formed crystals. These cavities are called *miarolitic*.

Differentiation of Igneous Rocks

It is a matter of common observation that magmas of different composition have been erupted not only from different vents, but from the same vent at different periods of time. This was formerly explained by some that at an unknown depth beneath the surface of the earth, there existed two layers of unlike magma, one lighter and more acid, the other heavier and more basic, and that the eruptions came from one or the other of these or a mixture of both. From the observed facts in the field it is now recognized that this assumption is inadequate as an explanation.

Plutonic igneous masses, such as granite stocks, etc., exposed now at the surface through erosion, frequently show a somewhat zoned arrangement; an outer margin of irregular width and extent whose mineral composition is essentially different from that of the larger central mass. That is to say, a border zone consisting of a greater concentration of the more basic, and sometimes the more acid, minerals than in the central mass. The two parts of the igneous mass usually contain the same minerals, but in different concentrations, and the passage from one to the other is frequently gradual.

A similar zonal arrangement has been observed in some laccoliths. Also similar evidence is afforded from the study of *complementary dikes*. Dikes composed of unlike mineral composition, one set light in color and density, and therefore acid in character; the other dark in color, heavier, and of basic character, have been observed cutting the rocks of a given area and closely associated. If this series of unlike dike material were sampled in proportion to their volumes and carefully analyzed, the bulk sample would reproduce the composition of the original parent magma. Such a system of dikes is termed *complementary*.

These geological facts are now generally agreed to by petrographers as being most satisfactorily explained on the assumption that magmas have the capacity, under certain conditions, of separating into submagmas of unlike composition as well as differing from that of the original magma, but if mixed in proper proportions they would reproduce the parent magma. "Regarding the division there seems to be in general two opposite poles towards which the submagmas tend; to one concentrate the iron, magnesia, and to a large extent the lime, to the other the alkalis, alumina, and to a great extent the silica. The one gives us ferromagnesian rocks such as gabbro, the other feldspathic rocks such as granite" (Pirsson).

The process of a magma separating into two submagmas is known as *magmatic differentiation*, and it may take place prior to intrusion or extrusion, or it may go forward in place. The process has been an important one in the genesis of some ore bodies (see Chapter on Ore Deposits).

It has been shown that the variety of igneous rock types occurring within a given area exhibit certain distinctive features which indicate their kinship, and therefore their derivation from a common parent magma. These kinship characters may be shown: (1) by the presence of certain minerals; (2) in the peculiarity of chemical composition; (3) in some cases by peculiar textures; or (4) in a combination of these. To express this kinship of associated igneous rock types, Iddings has proposed the convenient term *consanguinity*; and the area within which such related types occur is called a *petrographic province*, or a *comagmatic area* or *region*.

Classification of Igneous Rocks

Igneous rocks possess certain features by which the many different varieties recognized may be distinguished from each other, such as mode of occurrence, texture, mineral composition, chemical composition, etc. One or more of these features has been employed in classifying igneous rocks, but thus far not one of the many classifications proposed has been universally adopted. The difficulty lies chiefly in the fact that hard and fast lines cannot be drawn, since each of the several features enumerated above shows gradations, hence equal emphasis has not been placed on the same feature by all.

The scheme of classification of igneous rocks most generally employed by petrographers is based on three fundamental principles, namely, (1) texture, (2) mineral composition, and (3) chemical composition. It very often happens that the identification of the exact variety or kind of igneous rock is not possible by megascopic methods, such as involves a naked eye examination or the use of a pocket lens, but must be determined by microscopic and chemical study. The engineer, however, must rely on megascopic characters of igneous rocks in classifying them, using a scheme that is both useful and practical, and one that is based on the principal rock characters, such as texture and mineral composition.

Volcanic rocks may be glassy, stony, cellular, or porphyritic, while

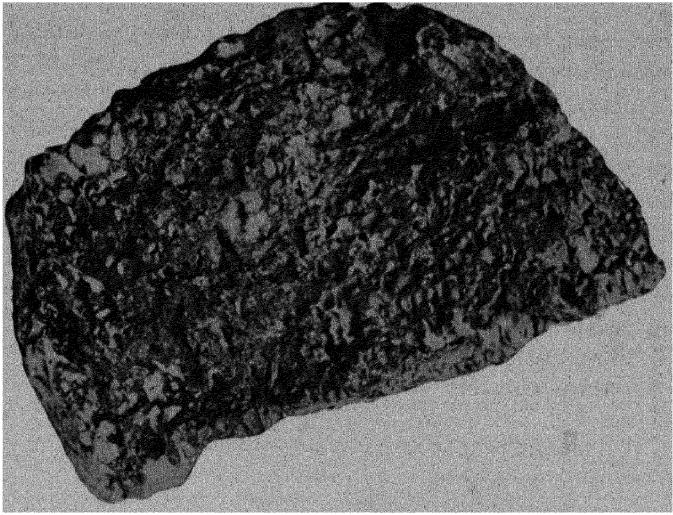

PLATE V, FIG. 1. — Basalt, showing vesicular texture.

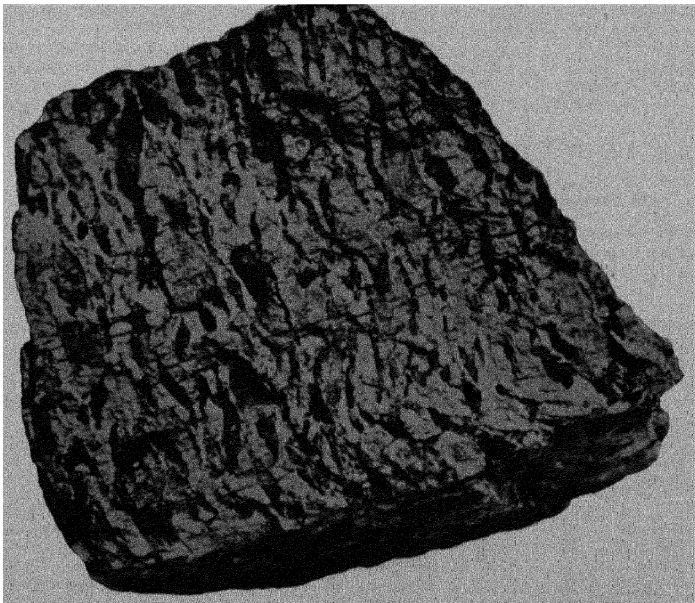

FIG. 2. — Graphic granite, showing characteristic intergrowth of quartz (dark) and feldspar (light).

the plutonic rocks are generally massive and holocrystalline, with porphyritic texture by no means uncommon. A rock, therefore, may have a uniform mineral composition, but vary in texture, depending upon the conditions under which it solidified. On the other hand, plutonic rocks may possess similar texture, but differ in mineral composition. These differences, either mineralogical or textural, lead to the development of different varieties of igneous rocks.

The following table, taken from Pirsson, expresses simply the mineralogical and textural characters of the more common kinds of igneous rocks, and is admirably adapted to the needs of the engineer. There are many more varieties of igneous rocks, as shown in the table on page 73, but these can hardly be distinguished megascopically.

MEGASCOPIC CLASSIFICATION OF IGNEOUS ROCKS

(A) *Grained, constituent grains recognizable. Mostly intrusive.*

	(a) Feldspathic rocks, usually light in color.		(b) Ferromagnesian rocks, generally dark to black.	
	With quartz.	Without quartz.	With subordinate feldspar.	Without feldspar.
Nonporphyritic.	GRANITE. (a) Aplite.	SYENITE. (a) Syenite. (b) Nephelite syenite. (c) Anorthosite.	DIORITE. GABBRIO. DOLERITE.	PERIDOTITE. PYROXENITE. Hornblendite.
Porphyritic.....	GRANITE-PORPHYRY.	SYENITE-PORPHYRY.	DIORITE-PORPHYRY.	

(B) *Dense, constituents nearly or wholly unrecognizable. Intrusive and extrusive.*

	(a) Light colored, usually feldspathic.	(b) Dark colored to black, usually ferromagnesian.
Nonporphyritic.....	FELSITE.	BASALT.
Porphyritic.....	FELSITE-PORPHYRY.	BASALT-PORPHYRY.

(C) *Rocks composed wholly or in part of glass. Extrusive.*

Nonporphyritic.....	OBSIDIAN, pitchstone, pearlite, pumice, etc. Vitrophyre (obsidian- and pitchstone-porphyry).
Porphyritic.....	

(D) *Fragmental igneous material. Extrusive.*

TUFFS, BRECCIAS (Volcanic ashes, etc.).

In the next table, taken from Kemp, the arrangement vertically from top to bottom is based on texture, and from left to right on mineral composition, chiefly in accordance with the predominant feld-

IGNEOUS ROCKS

Excess of Dark-colored Minerals → Basic.

Acid ← Excess of Light-colored Minerals.

Acid Glasses, Obsidian, Perite, Pumice, Pitchstone.		Andesite-Obsidian.		Basic Glasses, Scoriae, Tachylyte, Basalt-Obsidian.	
Chief Feldspar Orthoclase.		Chief Feldspar Plagioclase.		Nephelite, Leucite	
Biotite (or) Hornblende (or) Augite.		Biotite (or) and Hornblende.		Pyroxenes, Augite (or) and Hornblende (or) and Biotite.	
+Quartz.		+Quartz.		-Olivine. -Olivine +Olivine -Olivine.	
Rhyolite (Felsite).		Dacite Andesite (Felsite).		Basalt.	
Trachyte (Felsite).		Andesite Augite-Andesite		A series of rare basaltic rocks with Nephelite (or) and Leucite.	
Rhyolite porphyry.		Dacite porphyry.		Augite-Limburgite.	
Trachyte porphyry.		Andesite porphyry.		Augite-Limburgite porphyry.	
Granite porphyry.		Diorite porphyry.		Pyroxene-Peridotite porphyry.	
Syenite porphyry.		Nephelite-Syenite porphyry.		Peridotite porphyry.	
Granite.		Nephelite-Syenite.		Pyroxene-Peridotite porphyry.	
Granite.		Diorite.		Pyroxene-Peridotite porphyry.	
Rhyolite Tuffs and Breccias.		Dacite Tuffs and Breccias.		Basaltic Tuffs and Breccias.	
Trachyte Tuffs and Breccias.		Andesite Tuffs and Breccias.		Basaltic Tuffs and Breccias.	
80-85°C		60-80°C		55-58°C	
65-55°C		65-50°C		50-40°C	
60-50°C		70-60°C		55-45°C	
55-30%		55-45%		55-30%	
30-0%		30-0%		30-0%	
Crusts, Surface Flows.	Glassy.	Acid Glasses, Obsidian, Perite, Pumice, Pitchstone.	Andesite-Obsidian.	Basic Glasses, Scoriae, Tachylyte, Basalt-Obsidian.	Excess of Dark-colored Minerals → Basic.
Surface Flows.	(Glassy or Felsite) Phenocrysts few.	Rhyolite (Felsite).	Dacite Andesite (Felsite).	Basalt.	Basic Segregations in Normal Magmas.
Surface Flows.	Phenocrysts prominent.	Trachyte (Felsite).	Andesite Augite-Andesite	A series of rare basaltic rocks with Nephelite (or) and Leucite.	Meteorites.
Surface Flows.	Phenocrysts prominent.	Rhyolite porphyry.	Dacite porphyry.	Augite-Limburgite.	Water.
Surface Flows.	Phenocrysts prominent.	Trachyte porphyry.	Andesite porphyry.	Augite-Limburgite porphyry.	Ice.
Surface Flows.	Phenocrysts prominent.	Granite porphyry.	Diorite porphyry.	Pyroxene-Peridotite porphyry.	
Surface Flows.	Phenocrysts prominent.	Syenite porphyry.	Nephelite-Syenite porphyry.	Peridotite porphyry.	
Surface Flows.	Phenocrysts prominent.	Granite.	Diorite.	Pyroxene-Peridotite porphyry.	
Surface Flows.	Phenocrysts prominent.	Rhyolite Tuffs and Breccias.	Dacite Tuffs and Breccias.	Basaltic Tuffs and Breccias.	
Surface Flows.	Phenocrysts prominent.	Trachyte Tuffs and Breccias.	Andesite Tuffs and Breccias.	Basaltic Tuffs and Breccias.	
Surface Flows.	Phenocrysts prominent.	80-85°C	60-80°C	55-58°C	
Surface Flows.	Phenocrysts prominent.	65-55°C	65-50°C	50-40°C	
Surface Flows.	Phenocrysts prominent.	60-50°C	70-60°C	55-45°C	
Surface Flows.	Phenocrysts prominent.	55-30%	55-45%	55-30%	
Surface Flows.	Phenocrysts prominent.	30-0%	30-0%	30-0%	

spar present. This cannot always be determined by megascopic means, but requires the use of the polarizing microscope in the study of thin rock sections. The arrangement transversely also emphasizes in a general way the acid character of the rocks on the left side of the table and the basic nature of those on the right side. The percentages of silica given at the bottom of the table serve to indicate this general relationship of the rocks chemically.

DESCRIPTION OF IGNEOUS ROCKS

INTRUSIVE ROCKS

Granite

Mineral composition. — Granites are granular rocks composed of feldspar (microcline, orthoclase, albite, or their mixtures) and quartz, with usually mica (biotite or muscovite) or hornblende, rarely pyroxene. Some granites consist of feldspar and quartz alone. Soda-lime feldspar

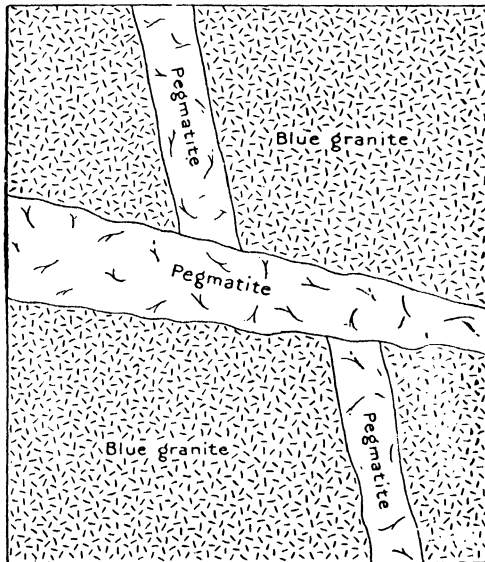

FIG. 60. — Granite cut by pegmatite dikes. (After Watson, U. S. Geol. Surv., Bull. 426.)

is generally present and frequently in large amount. Accessory minerals, such as apatite, zircon, magnetite, etc., in small amounts and usually of microscopic size are always present. The light-colored minerals are in marked excess, and feldspar is the predominant one.

Chemical composition.—The chemical composition of granite, though conditioned by mineral composition, is now regarded to be of less economic importance than the latter. The range in chemical composition is shown in ten analyses of United States granites given below:

SiO ₂	66.28-77.68
Al ₂ O ₃	11.63-16.38
Fe ₂ O ₃	0.00- 2.73
FeO.....	0.09- 1.88
MgO.....	0.04- 1.63
CaO.....	0.12- 3.75
Na ₂ O.....	2.85- 5.16
K ₂ O.....	1.87- 6.50
TiO ₂	Trace- 0.54
P ₂ O ₅	Trace- 0.30

Varieties.—Mineralogically, on the basis of essential minerals accompanying quartz and feldspar present, we may have (a) *muscovite granite*, containing muscovite; (b) *biotite granite*, containing biotite; (c) *muscovite-biotite granite*, containing both muscovite and biotite; or (d) *hornblende granite*, containing hornblende; etc. *Aplite*, a name formerly applied to those granites poor or lacking in mica, is now used for the fine-grained, muscovite granites, occurring in dikes. *Pegmatite* is a variety of granite, of usually very coarse crystallization of quartz, feldspar, and mica, with frequently rarer minerals, occurring in dikes or veins. Each of the three principal minerals may be utilized; the quartz and feldspar for pottery manufacture, etc.; and the mica, when in large colorless and transparent sheets, for lamp chimneys, stove doors, electrical purposes, etc. Pegmatite frequently shows a curious intergrowth of feldspar and quartz crystallized simultaneously, which on a cross fracture suggest cuneiform characters, and called *graphic granite* (Plate V, Fig. 2). Pegmatites are igneous in origin and have resulted by crystallization of the residual magma, unusually rich in mineralizers, especially water. The name *unakite* is given to a granite with pink feldspars and rich in epidote.

Physical properties.—The usual color of granite is some shade of gray, though pink or red varieties are not uncommon, dependent chiefly upon that of the feldspar, and the proportion of the feldspar to the dark minerals. Specific gravity ordinarily ranges from 2.63 to 2.75, according to the kinds and relative amounts of the principal minerals. As shown in Chapter XI, the percentage of absorption is very small, less than a fraction of one per cent; and the crushing strength is high, ranging from 15,000 to 20,000 pounds per square inch, properties which render the rock especially desirable for building purposes.

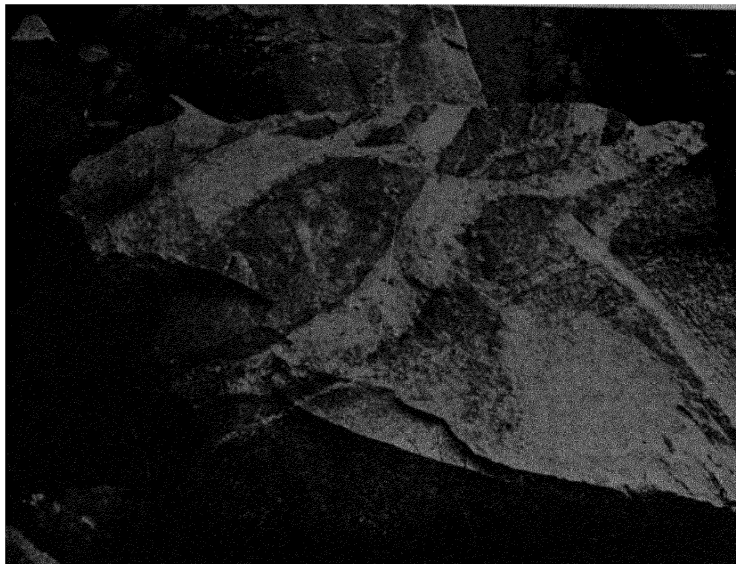

PLATE VI, FIG. 1. — Dikes of pegmatite in granite, Richmond, Va. (H. Ries, photo.) Much of the rock in quarry rejected because of these dikes.

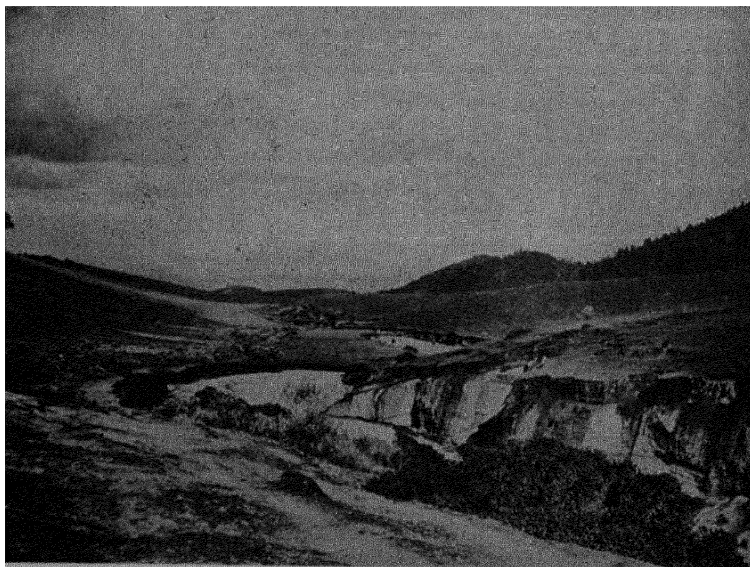

FIG. 2. — Volcanic ash deposits, on lower slopes of extinct volcano of Toluca in Mexico. (H. Ries, photo.) Note how the ash has been gullied by rain.

Texture and structure. — Texturally, granites are holocrystalline, even-granular to porphyritic rocks. Feldspars form the phenocrysts in porphyritic granites. Granites, therefore, possess a minimum of pore space and a maximum degree of strength. Structurally, normal granite is a massive rock without foliation or bands. When it takes on a foliated or banded structure, subsequent to its crystallization, it is no longer a true granite, but a *granite-gneiss*. For other structural features of granite, such as jointing, rift and grain, segregations (knots), and inclusions of foreign rocks, see under granites as a building stone in Chapter XI.

Mode of occurrence. — Granites are plutonic rocks that have cooled at depth beneath the surface. They form large irregular masses known as batholiths, also rounded exposures in other rocks (stocks or bosses), and dikes.

Weathering, distribution, and uses of granite are discussed under granites as a building stone in Chapter XI, and need not be repeated here. For granite as a source of subsurface water see Chapter VI.

Syenite

Mineral composition. — Syenites are granular rocks composed chiefly of feldspars of the same varieties as granite, or of the feldspathoids (nephelite, sodalite, etc.), with usually hornblende, mica, or pyroxene. They differ from granite in containing little or no quartz, and are therefore lower in silica. More or less soda-lime feldspar is always present, and when this approximately equals the potash feldspar in amount, the rock is called a *monzonite*, which marks a transition to diorite. Magnetite, ilmenite, apatite, and zircon are common accessory minerals. All gradations exist between syenite and granite on the one hand, and between syenite and diorite on the other. Likewise syenite and nepheline syenite may grade into each other.

Chemical composition. — Syenites are lower in silica than granites, but generally show an increase in all the bases, especially alumina and the alkalis, more particularly soda, which indicates the passage to the nephelite syenite variety. The chemical composition of syenite is shown in the two following analyses:

	SiO ₂	Al ₂ O ₃	Fe ₂ O ₃	FeO	MgO	CaO	Na ₂ O	K ₂ O	H ₂ O	Rest.	Total.
I.	60.2	20.4	1.7	1.9	1.0	2.0	6.3	6.1	0.3	0.4	100.3
II.	58.8	22.5	1.5	1.0	0.2	0.7	9.6	4.9	1.0	0.3	100.5

I. Fourche Mountain, Arkansas; II. Salem Neck, Massachusetts.

Varieties. — Like granites, syenites, according to the predominant ferromagnesian mineral, may be grouped into (a) mica syenites which, when occurring in dikes and of dark color, have been called *minette*; (b) *hornblende syenite*; and (c) *augite syenite*. Of more importance, however, and the one recognized in the two-fold division of syenites in rock classification is that based on the presence or absence of the feldspathoids, the most frequent one of which is nephelite, which serves to divide the syenites into:

(a) *Syenite* (common syenite) composed chiefly of feldspars, with or without dark minerals; and

(b) *Nephelite syenite* composed chiefly of feldspars and nephelite, with or without dark minerals.

Physical properties. — Syenites are light-colored rocks and show a range in color similar to granites, from nearly white through shades of gray to pink being the most common. Specific gravity ordinarily varies between 2.6 and 2.8, dependent on the kinds and proportions of minerals present.

Texture and structure. — Syenites are massive even-granular rocks, but porphyritic texture is sometimes developed. Like granites they may be characterized by joints, segregations (knots), and inclusions. They may show foliation or banding from metamorphism, when they are more properly called *syenite-gneiss*.

Mode of occurrence. — Syenites are not common rocks, and are of little importance as building stone, although they have equal value as granite for constructional purposes. Like granite, they form independent irregular masses and dikes, and are frequently associated with large bodies of granite, into which they grade by increase of quartz.

Weathering and uses of syenites are similar to granites (page 77). They are very much more restricted in distribution than granite. (See Chapter XI on Building Stone for distribution.)

Diorite

Mineral composition. — The diorites are granular rocks composed of plagioclase as the chief feldspar and hornblende or biotite, or both. Augite in subordinate amount is often present, and some orthoclase occurs in all diorites. Quartz enters into the composition of some diorites as an important constituent and the rock is then distinguished as *quartz diorite*. Iron ores, apatite, zircon, and titanite are common microscopic accessory minerals.

As now used the name diorite is applied to those granular rocks in which hornblende equals or exceeds feldspar in amount. Because of

fine-grained texture, it is not possible in many cases to determine by megascopic examination the dominant feldspar.

By increase of quartz and alkalic feldspar the diorites proper pass into the granites on the one hand, and by increase of pyroxene into the gabbros on the other. *Monzonite* is the intermediate type between syenite and diorite; and *quartz monzonite*, known also as *grano-diorite*, is intermediate between granite and quartz diorite.

Chemical composition. — The most important points to be observed in the chemical composition of normal diorites are the lower silica but notably increased percentages of the bases, iron, lime, and magnesia, over the granites and syenites, resulting in the increase in quantity of hornblende. Also soda is in excess of potash, which follows from the chief feldspar being plagioclase. Quartz diorites, on the other hand, show a higher silica percentage than diorites, but averaging lower than for granites, while lime and soda may be higher on account of the chief feldspar being plagioclase. These differences become apparent on examination of the analyses of quartz diorite and diorite, tabulated below.

	SiO ₂	Al ₂ O ₃	Fe ₂ O ₃	FeO	MgO	CaO	Na ₂ O	K ₂ O	H ₂ O	Rest.	Total.
I.	70.36	15.47	0.98	1.17	0.87	3.18	4.91	1.71	1.06	0.37	100.08
II.	67.54	17.02	2.97	0.34	1.51	2.94	4.62	2.28	0.55	1.20	101.01
III.	58.05	18.00	2.49	4.56	3.55	6.17	3.64	2.18	0.86	1.29	100.79
IV.	57.87	16.30	1.71	3.86	5.50	5.53	5.01	0.75	2.66	0.93	100.12

I. Quartz diorite, near Enterprise, Butte Co., California; II. Quartz diorite, Electric Peak, Yellowstone Park; III. Diorite, Electric Peak, Yellowstone Park; IV. Diorite, South Husent Creek, Butte County, Calif.

Varieties. — Mineralogically, we may effect a two-fold division of the diorite family into common *diorite* and *quartz diorite* (or tonalite) on the basis of the absence or presence of appreciable quartz.

Also, according to the ferromagnesian mineral present, one may distinguish *hornblende diorite*, which is diorite in its restricted sense, *mica* (biotite) diorite, and *augite diorite*. *Camptonite* is a variety of hornblende diorite; *kersantite* is a dioritic rock containing both biotite and plagioclase, and occurring in dikes. Diorites containing notable amounts of pyroxene, marking their passage into gabbros, have been called *gabbro-diorite*.

Physical properties. — Diorites are usually of a dark gray or greenish color, sometimes almost black, dependent upon the color of hornblende and its proportion to feldspar. Because of the increased amounts of ferromagnesian minerals, hornblende or biotite, or both, diorites have a higher specific gravity than granites, ranging usually between 2.85 and 3.0. They show a high compressive strength and a low percentage of absorption.

Texture and structure. — Typical diorites have granitoid texture, ranging from fine to coarse even-granular. Porphyritic texture is

sometimes developed but is probably less common than in granites. Structurally, diorites are massive rocks, but may be rendered foliated or schistose through dynamic metamorphism, and pass into gneisses and hornblende schists. Orbicular or spheroidal structure is well developed in some diorites (Chap. XI), and the rock has had a very limited use as an ornamental stone.

Mode of occurrence. — Diorites are common and widely distributed rocks. They frequently occur as independent intruded masses in the form of stocks and dikes, less often as batholiths, and are found connected with granite and gabbro masses into which they may grade.

Weathering, distribution, and uses of diorite are stated under building stone, in Chapter XI, but it may be added here that they are not as important commercially as granites.

Gabbro

Mineral composition. — The gabbros are granitoid intrusive rocks which, when typically developed, consist of pyroxene and plagioclase feldspar (labradorite or more calcic varieties). In typical gabbros the dark silicate minerals predominate over the light-colored ones, but rocks are included in the gabbro group which are composed practically of all plagioclase (chiefly labradorite), to which the name *anorthosite* has been given. Olivine is notably present in some gabbros which are known as *olivine* gabbro. Common accessory minerals include iron ores (magnetite and ilmenite) and apatite.

Extensive areas of anorthosite are known in Canada, the Adirondack Mountains, and elsewhere. Pyroxene occurs at times in subordinate amount, and by its increase the rock passes into gabbro proper. Iron ore minerals (magnetite or ilmenite) and more or less biotite and hornblende may also be present.

Chemical Composition. — The gabbros are characterized chemically by low silica (55 to 45 per cent), and high iron, magnesia, and lime. The alkalis are low but alumina is generally quite high. These general characters of the gabbro family are brought out in the table of analyses below.

	SiO ₂	Al ₂ O ₃	Fe ₂ O ₃	FeO	MgO	CaO	Na ₂ O	K ₂ O	H ₂ O	Rest.	Total.
I.	48.23	18.26	1.26	6.10	10.84	9.39	1.34	0.73	2.26	1.50	99.91
II.	47.16	14.45	1.61	13.81	5.24	8.13	3.09	1.20	0.60	4.69	99.98
III.	46.24	29.85	1.30	2.12	2.41	16.24	1.98	0.18	1.03	101.35
IV.	45.66	16.44	0.66	13.90	11.57	7.23	2.13	0.41	0.90	1.13	100.03
V.	44.76	18.82	2.19	4.73	11.32	14.58	0.89	0.11	2.53	0.36	100.29

I. Gabbro (bronzite norite), Crystal Falls, Michigan; II. Gabbro (norite), Elizabethtown, Essex Co., New York; III. Anorthosite, mouth of Seine River, Rainy Lake Region, Ontario; IV. Olivine gabbro, Birch Lake, Minnesota; V. Hypersthene gabbro, Wetheredville, Maryland.

Varieties. — The gabbro group is a large one, and many varieties of rock are represented, most of them being based on microscopic distinction in mineral composition and texture. The following may be enumerated, the first being the most important.

Diabase, when typically developed, is intermediate between gabbro proper and basalt, differing from the former in having lathe-shaped feldspars, resulting in the characteristic texture called *ophitic* or *diabasic* (Plate VII, Fig. 2). It occurs commonly as dikes, but also as sills in the eastern Atlantic states (Palisades of Hudson River), and is used chiefly for road material and paving blocks.

Olivine gabbro is a variety of the rock rich in olivine. If the pyroxene is an orthorhombic species, usually hypersthene, the rock is called *norite*. As stated under mineral composition, when the rock consists almost wholly of lime-soda feldspars with negligible amounts of other minerals, it is known as *anorthosite* (sometimes called *plagioclase* or *plagioclase rock*, common in Adirondack Mountains and eastern Canada. When the rock is composed of plagioclase and olivine without pyroxene it is called *troctolite*, a rare variety of gabbro.

Physical properties. — Gabbros proper are dark gray or greenish to black in color. Anorthosites are normally white or light-colored, but the rock is often grayish and sometimes almost black. The specific gravity will average slightly higher in typical gabbros than for diorites, the usual range being between 2.9 and 3.2. They possess a high degree of compressive strength and low absorptiveness, and are well suited for constructional purposes, in which they have had a limited use. They are susceptible of a high degree of polish, and have been used to some extent as monumental stock, but their very dark color has militated in part against their very extended use in this direction.

Texture and structure. — The gabbros, both texturally and structurally, are similar to the diorites. They are massive even-granular rocks, with porphyritic texture rarely developed. Orbicular texture, similar to that of some granites and diorites, though known, is but seldom observed.

Original banded structure may be noted in some gabbros, and dynamic metamorphism may mash them into their foliated equivalents, gneisses or schists. Another change which is a molecular one usually results from the action of pressure metamorphism. This is the transformation of the pyroxene to hornblende (uralite), the process being known as *uralitization*. This change may or may not be accompanied by the production of schistosity, and the rock may retain its original massive structure.

Segregations both large and small of iron ores (magnetite, but usually

ilmenite, or a mixture of the two, and of the sulphides, especially pyrrhotite) are common in gabbros of many localities, especially those of Wyoming, Minnesota, New York, and Canada, and of Norway and Sweden in Europe. (See Chapter on Ore-Deposits.)

Alteration. — The change of pyroxene to hornblende (uralite) in gabbros under the action of dynamic metamorphism has already been stated. Under the action of metamorphism garnet is frequently developed as a new mineral.

A second mode of alteration frequently observed in gabbros subjected to metamorphic action is that which changes the feldspar to saussurite, a mixture chiefly of albite and zoisite with other minerals. The process is known as *saussuritization* and the rocks showing it have been called *saussurite-gabbros*.

Through the action of atmospheric agencies (weathering) gabbros ultimately alter to deep red ferruginous clay soils.

Mode of occurrence. — Gabbros are fairly common rocks and have rather wide distribution. Their geological occurrence is similar to granite, and they may form batholiths, stocks, or bosses, and dikes.

For the *distribution* and *uses* of gabbros the reader is referred to Chapter XI on Building Stone.

Peridotite

Mineral composition. — Peridotites are ultrabasic intrusive rocks consisting chiefly of olivine, with usually more or less pyroxene, sometimes hornblende, and without feldspar, or if present in such small amount as to be negligible.

Chemical composition. — Chemically the peridotites are characterized by very low silica, little or no alumina and alkalis, and very large amounts of magnesia and iron oxides, and to a less extent lime. The following analyses will make clear these features in chemical composition.

	SiO ₂	Al ₂ O ₃	Fe ₂ O ₃	FeO	MgO	CaO	Na ₂ O	K ₂ O	H ₂ O	Rest.	Total.
I.	43.87	1.64	8.94	2.60	27.32	6.29	0.50	8.72	0.75	100.63
II.	40.11	0.88	1.20	6.09	48.58	2.74	0.74	100.34
III.	39.99	3.55	8.56	41.26	4.19	2.07	99.62
IV.	39.37	4.47	4.96	9.13	26.53	3.70	0.50	0.26	7.95	3.07	99.94
V.	38.40	0.29	3.42	6.69	45.23	0.35	0.008	4.35	1.34	100.38

I. Peridotite, Baltimore County, Maryland; II. Dunite, Corundum Hill, North Carolina; III. Peridotite, Olivine Range, New Zealand; IV. Peridotite, near Open Lake, Michigan; V. Dunite, Tula-meen River, British Columbia.

Varieties. — The more important varieties of peridotites usually recognized are: *Dunite*, composed chiefly of all olivine; *corlundite*, composed chiefly of olivine and hornblende, with sometimes pyroxene (hypersthene); *saxonite* (*harzburgite*),

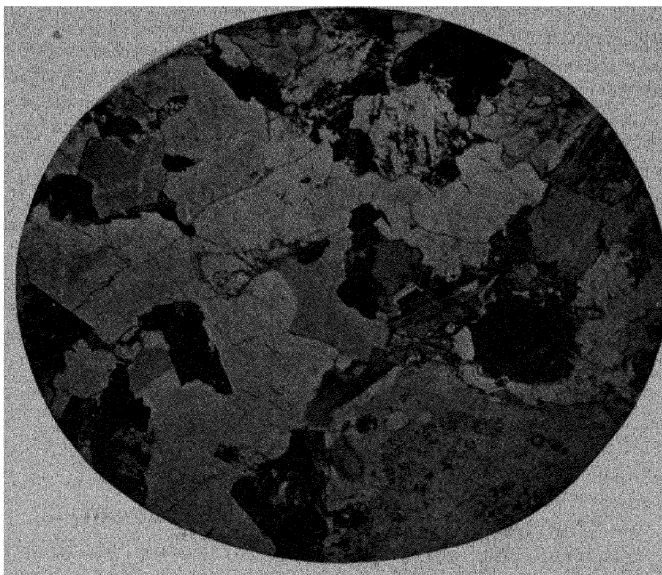

PLATE VII, FIG. 1. — Photomicrograph of a section of granite.



FIG. 2. — Photomicrograph of a section of diabase. (Both photos by A. B. Cushman, from Ries' Economic Geology.)

composed of olivine and orthorhombic pyroxene; *wehrlite*, composed of olivine and pyroxene (diallage); *herzolite*, composed of olivine and monoclinic and orthorhombic pyroxenes (diallage and hypersthene). Mica (biotite) occurs in some peridotites, designated *mica peridotite*.

These varieties may grade into each other and, while they are holocrystalline rocks, it is hardly possible to distinguish between them by megascopical means alone. In addition to the principal minerals mentioned as entering into the composition of peridotites, accessory ones usually are present, such as ilmenite, chromite, and sometimes garnet.

For megascopic purposes, a simplified classification of peridotites as given by Hatch, based on the ferromagnesian minerals present, is in some respects preferable to the one given above. It is: *Dunite*, olivine rock; *hornblende peridotite*, *pyroxene peridotite*, *hornblende-pyroxene peridotite*, and *hornblende-biotite peridotite*.

Physical properties. — The peridotites are usually very dark in color, varying ordinarily from some shade of green to black. The variety dunite is frequently some shade of light green. The specific gravity ordinarily ranges between 3.0 and 3.3.

Texture and structure. — Peridotites are granitoid rocks, with porphyritic texture essentially wanting. Those varieties containing pyroxene or hornblende, or both, frequently exhibit a mottling of the individuals of these minerals from inclosures of smaller grains of olivine; such texture has been called *poikilitic*. They are massive rocks but may be rendered schistose by pressure metamorphism.

Alteration. — Under atmospheric conditions peridotites are very susceptible to rapid alteration, the chief product being serpentine although talc is not uncommon. A certain amount of serpentinization is nearly always noted, as indicated in the analyses by the large percentages of water. They finally break down into ferruginous soils. The change to serpentine, as indicated by Pirsson, may be represented by the following reaction:

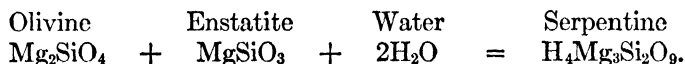

Mode of occurrence. — The peridotites, as independent masses, occur chiefly as dikes, although other forms, such as sheets, stocks, etc., are known. They are also associated at times with large intrusive masses of gabbro, into which they may grade.

For *distribution* and *uses* of peridotites see Chapter on Building Stone.

Pyroxenite and Hornblendite

These are rocks related to peridotite and are ordinarily treated as members of the peridotite group, but by some are included separately under the group name

perknite. They are not very common rocks and are not of great geologic importance. According to whether the dominant mineral is pyroxene or hornblende, we have either *pyroxenite* or *hornblendite*. Biotite, olivine, and iron ores may occur as accessory minerals.

Typical pyroxenite and hornblendite contain neither feldspar nor olivine. By the addition of feldspar they mark the passage into gabbros on the one hand, and of olivine into the peridotites on the other. They are very dark-colored rocks of high specific gravity, and occur both as dikes and deep-seated masses. Like the peridotites they alter readily on exposure to weather, and ultimately yield heavy ferruginous soils.

As indicated in the analyses below, they are characterized chemically by low silica, alumina, and alkalis, and by large percentages of magnesia, lime, and iron.

	SiO ₂	Al ₂ O ₃	Fe ₂ O ₃	FeO	MgO	CaO	Na ₂ O	K ₂ O	H ₂ O	Rest.	Total.
I.	50 80	3 40	1 39	8 11	22 77	12 31	Trace	Trace	0 52	0 73	100 03
II.	45 05	6 50	3 83	7 69	12 07	18.66	0 94	0.78	2.40	2 96	100 88
III.	46 4	10 8	5 9	5 6	22 2	3.7	0 3	1 2	3.8	. . .	100.1

I. Pyroxenite, Baltimore County, Maryland; II. Pyroxenite, Brandberget, Gran, Norway; III. Hornblendite, Valbonne, Pyrenees.

VOLCANIC OR DENSE IGNEOUS ROCKS

Introduction.—In this group are included those igneous rocks that have formed on or near the surface, and because of the conditions of rapid cooling the resulting component minerals are so small in size that they cannot be distinguished by the naked eye, but require the microscope to identify them. Because of this fact they are usually referred to as dense igneous rocks in contradistinction to the grained or plutonic rocks that have formed at great depth beneath the surface, and whose principal minerals are usually large enough to be identified megascopically, chiefly because of the slower rate of cooling. The two groups of rocks, however, grade into each other, and no sharp line of demarcation can be drawn between them.

The volcanic rocks may be classified in the same manner as the plutonic igneous rocks, and for every type of the latter a volcanic equivalent is recognized. For such division of the volcanic rocks we must rely on the methods of microscopic study of thin rock sections, since it is not possible to distinguish between them by megascopic study for the reasons previously stated. On this basis we may make the following divisions of the volcanic rocks corresponding to the plutonic equivalents described in the following pages and presented in tabular form on page 86.

Volcanic	Rhyolite	Trachyte	Phonolite	Dacite (Quartz andesite)	
Plutonic	Granite	Syenite	Nephelite-syenite	Quartz diorite	
Volcanic	Andesite	Augite (Andesite)	Basalt	Augitite	Limburgite
Plutonic	Diorite	Gabbro	Olivine gabbro	Pyroxenite	Peridotite

For megascopic purposes this grouping of volcanic rocks cannot be followed, since the principal minerals are indistinguishable by the naked eye. By adopting color as the basis of classification, which expresses in a general way the mineral composition of the rocks as to whether light- or dark-colored minerals predominate, we may group the volcanic rocks into two principal divisions, namely, (a) *felsites* and (b) *basalts*.

On the color basis, felsites comprise the light-colored volcanic rocks, which are dominantly feldspathic, with or without quartz and the feldspathoids, and would include rhyolite, trachyte, and phonolite of the table on page 73. The remaining types comprising andesite, basalt, augitite, and limburgite, consisting of nearly equal or larger amounts of ferromagnesian minerals, with or without lime-soda feldspar, would be included under the single term basalt.

The felsites and basalts as thus defined are described below.

Felsite

The felsites include the dominantly feldspathic varieties of fine-grained volcanic rocks, with or without quartz and the feldspathoids, which are light in color, white, light to medium gray, red, yellow, brown, or green, and comprising the microscopic types rhyolite, trachyte, and phonolite. They sometimes show porphyritic texture, and may be designated *felsite porphyry*. Vesicular or cellular structure is less common in the felsites than in the basalts. Frequently, flow structure is visible to the naked eye. The usual range in specific gravity is from 2.4 to 2.7. Since the rocks grouped as felsites are very fine-granular, it is not possible to affect a classification of them megascopically on the basis of mineral composition. Megascopically, then, such division as may be made of them must be based on color and texture.

Chemical composition. — The chemical composition of felsites is quite variable, dependent upon the mineral composition. The rhyolites correspond to granites, trachytes to syenites, phonolites to nepheline syenites, etc. The table below will serve to indicate the composition of some of the more important varieties of felsite. These should be compared with analyses of their plutonic equivalents on pages 62, 75, 77.

ANALYSES OF FELSITES

	SiO ₂	Al ₂ O ₃	Fe ₂ O ₃	FeO	MgO	CaO	Na ₂ O	K ₂ O	H ₂ O	Rest.	Total.
I.	75.98	12.34	0.85	0.93	0.15	0.13	4.02	4.44	0.88	0.30	100.02
II.	75.34	12.51	0.42	1.55	0.32	1.07	3.31	4.17	0.86	0.49	100.04
III.	63.24	17.98	2.67	0.85	0.63	0.93	6.27	5.47	1.17	0.73	100.14
IV.	62.17	18.58	2.15	1.05	0.73	1.57	7.56	3.88	1.70		99.22
V.	57.86	20.26	2.35	0.39	0.04	0.89	9.47	5.19	2.61	0.91	99.97
VI.	56.24	21.43	2.01	0.55	0.15	1.38	10.53	5.74	0.98	0.85	99.86
VII.	68.10	15.50	3.20	None	0.10	3.02	4.20	3.13	2.72	0.24	100.21

I. Rhyolite from Haystack Mountain, Aroostook County, Maine; II. Rhyolite from "Elephants' Back," Yellowstone National Park; III. Trachyte, Dike Mountain, Yellowstone National Park, IV. Trachyte, Crazy Mountains, Montana; V. Phonolite, Black Hills, South Dakota; VI. Phonolite, Pleasant Valley, Colfax County, New Mexico; VII. Dacite, Bear Creek Falls, Shasta County, California.

Mode of occurrence. — The chief occurrences of felsites are as dikes and lava flows or sheets, the latter being the more common. They are found in many localities in the eastern United States, but are especially abundant as lava flows and sheets in the West.

Uses. — The felsites have only been utilized to a small extent, since their textures usually render them unsuited for any save the rougher classes of constructional work. As a rule they will not polish, and their rough appearance makes them unfit for interior decorative purposes. In the western states and Mexico, for example, they give satisfaction for dimension blocks.

Basalt

The basalts include the very dark-colored igneous rocks which correspond to the felsites in texture. Mineralogically they agree with the diorites and gabbros, and are gray black to black in color, but are less lustrous in appearance than many of the felsites. Cellular and amygdaloidal structures are common in the basalts, and while porphyritic texture is sometimes observed it is less frequent than in the felsites. Pyroxene, olivine, and feldspar may occur as phenocrysts, when the rock exhibiting such porphyritic texture is conveniently called *basalt porphyry*, which bears the same relation to basalt that felsite porphyry does to felsite.

The range in specific gravity is high, usually from 2.9 to 3.1. The basalts megascopically are recognized by their dark color and high specific gravity. Columnar jointing is common (Plate VIII), one of the best examples being that of the Giants' Causeway on the north coast of Ireland.

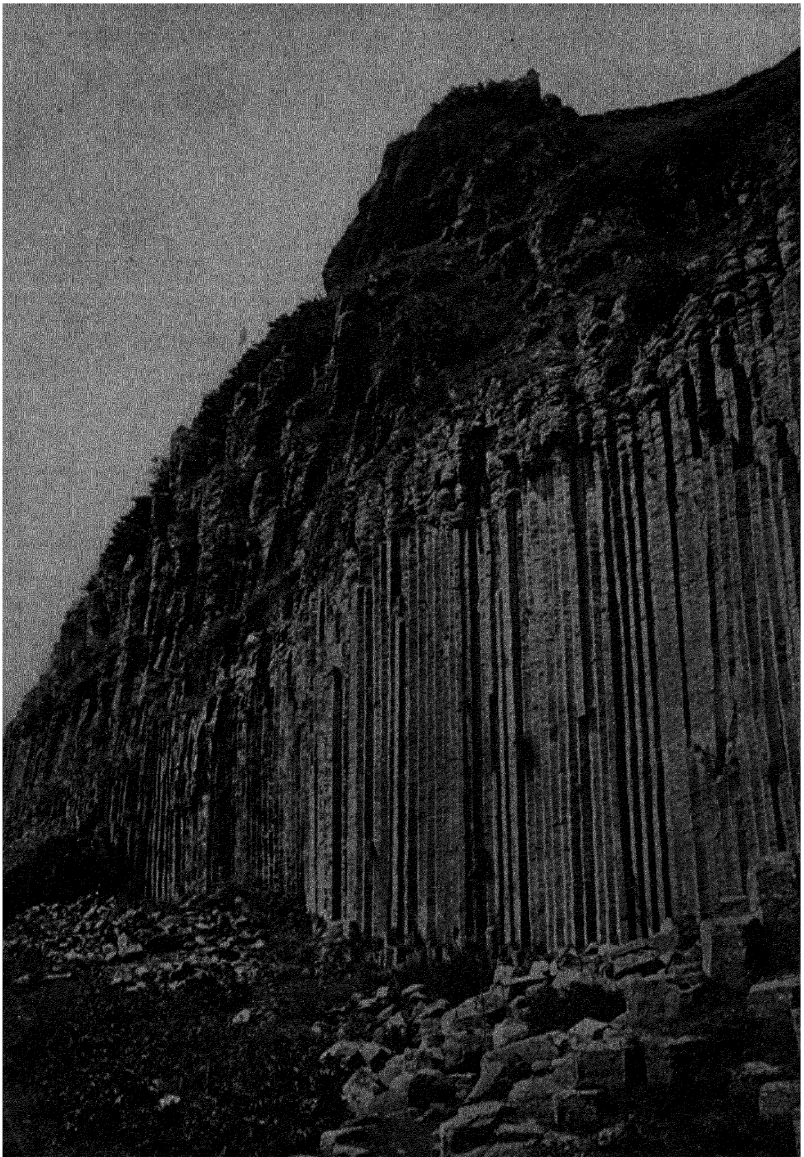

PLATE VIII.— Columnar jointing in basalt, Le Puy, France.

Chemical composition. — Like felsite, the chemical composition of basalt is variable and depends on mineral composition. The range in composition is shown in the following chemical analyses:

ANALYSES OF BASALTS

	SiO ₂	Al ₂ O ₃	Fe ₂ O ₃	FeO	MgO	CaO	Na ₂ O	K ₂ O	H ₂ O	Rest.	Total.
I.	56 88	18 25	2 35	4 45	4 07	7 53	3 29	1 42	0 74	1 08	100 06
II.	56 63	16 85	3 62	3 44	4 23	7 53	3 08	2 24	1 31	1 25	100 18
III.	52 40	13 55	2 73	9 79	5 53	10 01	2 32	0 40	1 67	1 59	99 99
IV.	48 76	15 89	6 04	4 56	5 98	8 15	3 43	2 93	1 88	2 61	100 23
V.	45 11	12 44	2 67	9 36	11 56	10 61	3 05	1 01	0 94	3 27	100 02
VI.	43 35	11 46	11 98	2 26	11 69	7 76	3 88	0 99	3 00	3 97	100 34
VII.	38 62	13 90	5 97	8 65	11 21	15 54	2 01	0 57	1 46	2 76	100 69

I. Andesite, Franklin Hill, Plumas County, California; II. Andesite, Unga Island, Alaska; III. Basalt, Pine Hill, South Britain, Connecticut; IV. Basalt, Saddle Mountain, Pike's Peak, Colorado; V. Basalt, Pinto Mountain, Uvalde County, Texas; VI. Augitite, Hutberg, Tetschen, Bohemia, VII. Limburgite, Dakar Peak, Cape Verde Islands.

Mode of occurrence. — Basalts are widespread in occurrence, chiefly as lava flows or sheets, and dikes. They are abundantly developed both in the eastern and western United States, the most extensive area being that of the Snake River region covering parts of Idaho, Oregon, and Washington, the dark lava beds having an areal extent of many thousand square miles and hundreds of feet in thickness.

Uses. — The porous, cellular varieties of basalt should be excluded from use as a constructional material, but there seems no reason why the dense compact varieties should not be used in those regions where it occurs, although its toughness and abundant jointing make the extraction of dimension blocks difficult. Color and lack of susceptibility to good polish preclude it from use as an interior decorative stone. It can be used for crushed stone. The younger basalts may supply much subsurface water (Chap. VI).

GLASSY IGNEOUS ROCKS

Under glassy rocks are included those igneous rocks which are composed essentially or entirely of glass. They represent, with only rare and unimportant exceptions, molten lavas poured out onto the surface which have undergone extremely quick solidification, aided probably to some extent by the rapid escape of mineralizers. Any magma under proper conditions of rapid chilling may solidify as glass, but the most common ones show a high percentage of silica and correspond to granite in composition.

Some glassy rocks may contain distinct crystals or phenocrysts, and are known as *glass porphyry* or *vitrophyre*. More often, however, porphyritic texture is not developed, and we may recognize the following principal varieties of glassy rocks, based on luster and structure: *Obsidian*, a homogeneous glass, of bright vitreous luster, jet black to red in color, and having conchoidal fracture; *pitchstone*, a homogeneous glass of dull or resinous luster, black to red, brown, and green in color, and containing from 5 to 10 per cent of water; *perlite*, a glass broken by concentric cracks on cooling, and made up of small spheroidal masses, usually of gray color, rarely red; *pumice*, an excessively porous or cellular glass, due to the escape of water vapor at high temperature through relief of pressure, and usually white or gray in color, though darker shades sometimes occur.

The glassy rocks vary from dense and compact homogeneous rocks, having conchoidal fracture, to those that are highly vesicular or cellular, and may show characteristic flow structure (Plate IV, Fig. 1). The usual range in specific gravity is from 2.34 to 2.7. Under conditions of metamorphism (pressure, heat, water, etc.) the glassy rocks, especially the older ones, alter into rocks composed of definite minerals (feldspar and quartz chiefly) and of stony texture, the process being described as *devitrification*.

Chemical composition. — The range in composition of some of the more important varieties of glassy rocks is shown in the analyses tabulated below. These should be compared with analyses of the granular rocks on pages 80, 97.

ANALYSES OF VOLCANIC GLASS

	SiO ₂	Al ₂ O ₃	Fe ₂ O ₃	FeO	MgO	CaO	Na ₂ O	K ₂ O	H ₂ O	Rest.	Total.
I.	75.52	14.11	1.74	0.08	0.10	0.78	3.92	3.63	0.39	0.11	100.38
II.	73.11	13.16	0.62	0.23	0.19	0.54	2.85	5.10	4.05	0.14	99.99
III.	78.84	12.47	0.32	0.90	0.25	1.08	2.88	5.38	2.76	Trace	99.88
IV.	79.49	11.60	0.32	0.49	0.09	1.64	4.04	1.52	0.68	None	99.88
V.	53.52	13.56	4.93	6.61	7.37	7.39	3.22	0.68	1.03	1.84	100.05
VI.	42.25	16.87	5.24	10.72	6.91	3.33	3.96	0.77	6.01	3.67	99.84

I. Obsidian, Obsidian Cliff, Yellowstone National Park; II. Pitchstone, Rosita, Colorado; III. Perlite, Midway Geyser Basin, Yellowstone National Park; IV. Pumice, Cinder Cone, California; V. Basalt obsidian, Londorf, Vogelsberg, Hesse; VI. Diabase glass, Mars Hill, Aroostook, Maine.

Mode of occurrence. — The glassy rocks sometimes occur as independent sheets and dikes, but usually they form the surface of lava flows and at times the marginal portions of dikes. They are found, therefore, in volcanic regions, and are especially abundant in the West,

but are also found in the eastern United States. Obsidian Cliff in the Yellowstone National Park is a noted locality.

Uses. — Volcanic glasses have not been quarried for commercial purposes, but some of them could be used to advantage as interior decorative stone, since some are quite ornamental and are susceptible of a high polish.

PORPHYRITIC IGNEOUS ROCKS (PORPHYRIES)

The term porphyry, when applied in the broad sense, includes all igneous rocks, regardless of mineral composition and therefore of rock-type, that show porphyritic texture. It is in this sense that the word porphyry is used in this book. As previously stated in the description of the different kinds of igneous rocks, porphyritic texture may be developed in either the granitoid, felsitic, or glassy rocks. Megascopically then the porphyries may be subdivided into (1) those porphyritic rocks whose groundmass is sufficiently coarse-granular that its principal minerals may be distinguished by the naked eye; and (2) those porphyritic rocks whose groundmass is either felsitic or glassy in texture, and in which only the phenocrysts may be identified by the unaided eye.

On this basis of classifying the porphyritic rocks, the first group will include the granitoid rocks having porphyritic texture, such as *porphyritic granite*, *porphyritic syenite*, etc. Such texture is developed chiefly in the feldspathic members of this group, with feldspar probably the most frequent mineral formed as phenocrysts, which may or may not show outward crystal form.

The second group includes all felsitic and glassy igneous rocks having porphyritic texture, such as *felsite porphyry*, *basalt porphyry*, and *glass porphyry* or *vitrophyre*. The phenocrysts may consist of either light-colored (quartz and feldspar) or dark-colored (hornblende, pyroxene, biotite, or olivine) minerals. Porphyries are common to both the light (acid) and dark (basic) igneous rocks belonging to the group of dense-textured ones.

In chemical and mineral composition, specific gravity, alteration, etc., the porphyries are similar to their corresponding granular types of rock, and from the standpoint of durability they may be utilized for the same purposes. They have wide distribution, and show a variety of colors. Many of our important ore deposits of the West are associated with porphyries, and in the West the word porphyry is used for almost every igneous rock occurring in sheets or dikes in connection with ore deposits (Kemp). (See Chapter on Ore Deposits.)

In many of the porphyries, the phenocrysts contrast strongly in color with that of the groundmass, and exhibit a beautiful effect on polished surfaces. They are hard and durable, usually without rift or grain, and often of beautiful color, but have been used to a very limited extent as decorative stone in the United States.

PYROCLASTIC OR VOLCANIC FRAGMENTAL ROCKS

Under pyroclastic rocks are included all fragmental materials erupted by volcanoes, regardless of size and shape. Masses of rock weighing tons are sometimes thrown out, and from this size the material grades down to that of dust-like particles.

The different kinds of volcanic fragmental material recognized are: (1) *Volcanic blocks*, the large irregular-shaped masses, angular to somewhat rounded, and measuring several feet and more in size; (2) *bombs*, round or elliptical-shaped masses of lava, ranging from a few inches up to a foot and more in diameter; (3) *lapilli*, fragments of lava of indefinite shape, ranging in size from a pea to that of a walnut; and (4) *volcanic ash* (Plate VI, Fig. 2) or *dust*, the finer particles of lava ejected, including all sizes below that of a pea.

The larger fragments accumulate near the vent or opening, while the finer material may travel some distance before falling to the surface. They may cover extensive areas and accumulate to considerable depths, and are sometimes interbedded with lava flows as shown in Fig. 59. Consolidation of the fragmental material into more or less firm rock may take place either on land or under water; in either case the rock usually shows stratification. The finer volcanic materials after consolidation yield *volcanic tuffs*; the larger and coarser materials give *volcanic breccias*. Other names, such as *volcanic agglomerate* and *volcanic conglomerate*, have been applied to the consolidated coarse material, according to size and shape of the fragments.

The volcanic tuffs and breccias may receive different names, according to the nature of fragments composing them; such as, *rhyolite-tuffs*, *trachyte-tuffs*, *andesite-tuffs*, *basalt-tuffs*, etc. Those magmas of acid composition (high silica), corresponding to felsite, are more apt to yield fragmental material than the more basic or low silica ones of the composition of basalt, because chiefly of their greater viscosity and greater difficulty of escape of the vapors.

Chemical composition. — The following analyses show the chemical composition of some of the types of volcanic fragmental rocks:

ANALYSES OF VOLCANIC FRAGMENTAL ROCKS.

	SiO ₂	Al ₂ O ₃	Fe ₂ O ₃	FeO	MgO	CaO	Na ₂ O	K ₂ O	H ₂ O	Rest.	Total.
I.	70.01	12 61	1.47	0 50	0 72	1 06	1 94	5.12	4.68	0 04	100 52
II.	61 15	15 70	4 31	1 12	3.04	2 84	1 54	2 22	7.05	1 44	100 59
III.	52 24	21 08	4.41	n.d.	0.60	2 68	4 58	6 43	8 33	0.08	100.43
IV.	57 16	20 06	2.84	1 95	1 55	4 41	5 84	4.52	1.09	2 67	102.09
V.	47 44	16 51	15 33	3 19	8 80	6 02	1 60	0 30	...	1.12	100 48

I. Rhyolite tuff, Willard's Creek, Lassen County, California, II. Trachyte tuff, Two Ocean Pass, Yellowstone National Park, III. Phonolite tuff, Schorenberg, Eifel Rh., Prussia; IV. Andesite tuff, Nightingale Island, Tristan d' Acunha, South Atlantic; V. Basalt tuff (not fresh, 14.12 per cent H₂O), Salt Lake, Oahu, Hawaiian Islands.

The volcanic fragmental rocks, especially the tuffs, show a variety of color. The more recent ones are usually only partially consolidated, are soft and porous, and are capable of absorbing large quantities of water. On the other hand, the older ones are often compact and hard and their fragmental character may not be evident to the naked eye. They may be moderately strong, but are usually light in weight.

Volcanic tuffs have wide distribution in the West, and have more restricted occurrence in the East. They have been employed only to a limited extent for building purposes in this country, but have a more extended use in Mexico and locally in several of the European countries. They are usually soft and easy to work, but owing to their porous nature they may be used to best advantage only in dry climates. As a rule, they will not polish because of their textures.

SEDIMENTARY ROCKS

Introduction.—The rocks included under this head, known also as *stratified rocks*, are of a secondary or derivative origin, since they have been formed chiefly from pre-existent ones. A few have been formed from the remains of plants and animals. The source of the material entering into the composition of most sedimentary rocks may have been derived from pre-existing igneous, metamorphic, or stratified rocks. Indeed, the earliest sediments are regarded by most geologists as having been derived from already existing igneous rocks.

The materials composing the sedimentary rocks have been laid down under water or on land, and have been derived from the disintegration (physical) and decomposition (chemical) of pre-existing minerals and rocks, and of plants and animals, as discussed under Weathering in Chapter IV. As a rule this material has been moved from its original position by various agents: (1) Partly as mechanical

sediments in the form of solid particles of different sizes and shapes; and (2) partly as dissolved salts in solution. The principal agents involved in shifting the position of this material are: (1) Moving water, the most important one, forming *aqueous* sediments, which comprise the vast majority of sedimentary rocks; (2) mechanical action of wind forming *æolian sediments*, which are of less importance; and (3) ice, chiefly glacial, forming in this case *glacial sediments*.

According to the agents involved in the deposition of sedimentary rocks we may have (a) *mechanically-formed sediments*; (b) *chemically-formed sediments*; and (c) *organically-formed sediments*.

GENERAL PROPERTIES OF SEDIMENTARY ROCKS

Variation in size of material. — The products of rock decay vary greatly in size, but when subjected to the action of running water they are sorted and graded into particles of approximately equal size, in accordance with the strength of current, as explained in Chapter V. Grouped then according to size, beginning with the coarsest, the following names for this material may be employed: (1) *Boulders* and *cobbles*, the coarsest material, ranging down to 3 or 4 inches in diameter; (2) *gravel*, including all material below cobble size down to 1 millimeter ($\frac{1}{25}$ inch) in diameter; (3) *sand*, ranging from 1 to 0.05 millimeter ($\frac{1}{25}$ to $\frac{1}{200}$ in.) in diameter; and (4) *clay* and *silt*, ranging from .05 to .0001 millimeter ($\frac{1}{200}$ in. to $\frac{1}{10000}$ in.) in diameter. Gradation of these into each other is very common. They are unconsolidated mechanical sediments.

Gravel. — Gravels have wide distribution. They are characteristic of shallow water and land conditions, and may be composed of a single kind of rock but more often are a mixture of many kinds, the latter being especially true of glacial and beach gravels. The pebbles also vary in size or shape and degree of freshness. In mode of occurrence gravels are of most importance in beaches; in deltas, alluvial plains, and terraces of fluvial origin; and in aqueoglacial deposits, such as kames, eskers, valley trains, outwash aprons, etc.

Gravel deposits are seldom clean, most of them containing sand or even clay; hence washing and screening are usually necessary before using them. They are used in roads (Chap. XVI), concrete, railroad ballast, filter beds, etc. They are also of frequent commercial importance in some regions for the metallic minerals which they contain, as

gold, platinum, tin, etc., and some gem minerals such as diamond. Such gravel deposits are known as *placers*. (Chap. XVII).
(See chapter on Ore-Deposits.)

Sand.¹—The name sand refers to size of grain and not to mineral composition. The prevailing kinds are composed of the more resistant minerals, such as quartz, which is the most common in sands, but many other minerals may be present. Thus we may have sands that are composed largely of grains of dolomite, gypsum, magnetite, coral rock, shale, etc.

In some cases sand is simply the product of rock disintegration by weathering, but in other instances, mixed products of weathered rock may be removed by streams, glacial ice, or wind, the materials of different size being sometimes separated and sorted, and the sand separately concentrated. Other sands may originate by the grinding action of waves along the coast. Wind-blown or aeolian sands are discussed on page 113.

The shape of sand grains is usually closely related to their origin. Sands formed in moving water, either in the sea or in rivers, have a subangular character; wind-blown sands are characterized by remarkably well-rounded grains; while the grains of glacial sands are angular, when they have not been subsequently modified by water. (Hatch and Rastall.)

Siliceous sand is used for mixing with cement or lime to make concrete and mortar, for filtration purposes, road making (Chap. XVI), sand-lime brick, mold cores, glass, etc. Gypsum sands can be used for plaster manufacture, glauconite sands as fertilizer, and monazite sands as a source of certain rare earths, especially thorium, which is used in the incandescent mantle industry.

Sand used for concrete should preferably be clean, free from gravel, clay, and organic matter. Soluble salts and calcareous grains are undesirable. In some localities an excellent natural sand for concrete may occur, while in others the material may contain so much gravel and clay as to necessitate its being washed and screened to remove these substances. As a rule concrete sand is usually obtained from local sources, and some rather poor material is occasionally employed.

Filter sands should be clean, and composed of grains which are preferably rounded and of fairly uniform size. Sand for asphalt roads is usually fine-grained and siliceous. For sand-lime bricks the sand should be free from clay, the grains preferably under 20 mesh in size, and not over 10 to 15 per cent passing 100 mesh.

Molding sands are usually siliceous, and contain from perhaps 10 to 20

¹ For special uses of sand see: U. S. Bur. Mines, Repts. Invest., No. 2622, and Weigel, A.I.M.E., LXXIII, p. 434, 1926.

per cent of clayey matter. The sand grains vary from coarse to fine depending on the size and smoothness of the casting to be made. Core sands contain little or no clay, and are held together with an artificial binder. Glass sands should be highly siliceous and contain but a few tenths, or for high grade glass, but a few hundredths percent of iron oxide.

In some regions of volcanic rocks, volcanic sands are used in making puzzolan cement, while others have been used for sand blasting.

Calcareous sand, consisting of shell and coral fragments, are common along some sea coasts. Magnetite sands occasionally occur in quantity, but are little used, as they are commonly highly titaniferous.

The following sieve tests of siliceous sands employed for different purposes will serve to show their variation in texture.

Sieve Tests of Sands

Mesh	1	2	3	4	5	6	7
On 6		5.18	1.18				
12	.46	10.28	8.58		.37		.42
20	.64	12.38	16.28	.09	.49	1.22	.88
40	2.18	40.20	37.94	4.50	1.39	24.84	8.40
70	11.10	20.50	21.40	64.10	17.59	67.09	39.68
100	14.96	2.64	2.60	21.79	49.59	6.10	18.84
140	15.78	12.90	.54	6.42	14.92	.39	9.62
200	13.50	1.30	1.00	1.78	12.09	.16	4.38
270	14.84	.14	.14	.55	.59		3.88
Through 270	13.88	.68	.56	.34	2.04	.09	6.38
clay ...	12.30		10.10				7.50

1. Molding sand for small castings; 2. Concrete sand, a washed product; 3. Plaster sand; 4. Glass sand; 5. Sand used in bituminous macadam; 6. Dune sand; 7. Concrete sand, with clayey impurities.

Texture of sedimentary rocks. — Texture as here defined relates to size and shape of the individual grains or particles composing the rocks. The size of individual grains varies within very wide limits, from coarse material like boulders and gravel which form when consolidated conglomerates (Plate X, Fig. 2), through sand cemented into sandstone (Plate X, Fig. 1), to fine material like mud, silt or clay, forming shales. The shape of the component grains depends chiefly upon whether they have been transported or not, and if moved by running water the amount of wear they have suffered in transit. Thus, the range in shape is from smooth and well rounded, through subangular, to entirely angular material. The rounded water-worn coarse material when consolidated yields *conglomerates* (Fig. 62), but when angular and consolidated produces *breccias* (Fig. 61). The texture of a sedimentary rock affects its value as a building stone to some extent. Other things being equal, fine-grained ones carve

and split better, as well as being often more durable, although there are occasional exceptions to this rule.

Cementation of sedimentary material into solid rock. — After the loose materials of different sizes described above have been deposited, they may become cemented into solid rock through the deposition of mineral matter held in solution by the percolating waters.

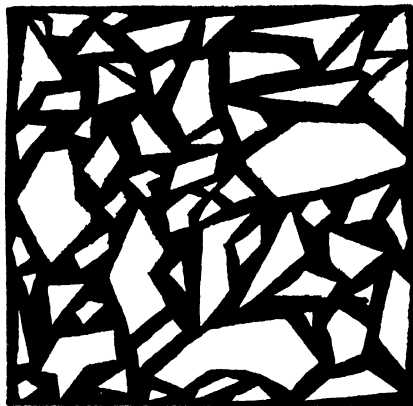

FIG. 61. — Sketch showing structure of a breccia.

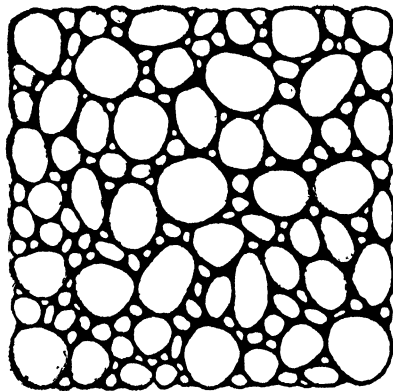

FIG. 62. — Sketch showing structure of a conglomerate.

This cement binds the pebbles, grains, and smaller particles together, converting them from loose masses into solid firm rock. The common cementing substances deposited from solution, which serve to bind the loose materials, are silica, calcium carbonate, and iron oxide. Sometimes the finer clay-like substances mechanically deposited with the coarser material act as the cement or binder. The finer sediments like clay, mud, etc., may be converted into solid rocks by pressure, without the deposition of a cementing material.

In some sandstones, for example, the cement is composed to a large extent of secondary minerals. Thus in the case of certain feldspathic sandstones which were being examined with a view to using them in the construction of the Ashokan dam in the Catskill Mountains, it was found that their exceptional strength was due to "modifications of texture that have resulted from the alteration and reconstruction of the mineral constituents. The breaking up of the orthoclase feldspar, and the accompanying changes in the ferromagnesian minerals, have furnished considerable secondary quartz,

which has in part attached to the original quartz grains making them more angular and developing an interlocking tendency. At the same time the fibrous sericitic and chloritic aggregates have developed to such extent as to fill most of the remaining pores, and in many cases the fibrous extensions have actually grown partly around the adjacent quartz grains. The effect has been to develop a siliceous binding of unusual toughness. This combination of changes has made a rock that is now remarkably well bound and interlocked for a sedimentary type.”¹

Quantity of cement. — All gradations may exist between hard, firm, and compact rocks to more or less loose and friable ones. A rock may be composed entirely of hard grains, such as quartz, and yet be bound together by so little cement that the rock as a whole is soft and porous. On the other hand, a rock although composed of soft mineral grains like calcite, may be so well fastened by the cement, as to form a hard, dense mass. We can see from this that the strength of a sedimentary rock must depend mainly on the tightness with which the grains are bound together, for the particles do not interlock as they do in igneous rocks. The quantity as well as kind of cement may therefore influence the stone's porosity, hardness, and resistance to abrasion and frost.

Color of cement. — A wide range of color may be shown according to the composition of the cement. Iron oxide cement is some shade of yellow, red, or brown; silica and calcium carbonate if free from impurities would be white; and clay, if present in appreciable amount, may impart a grayish color. Silicates, sometimes of secondary character, may give the stone a bluish or greenish tint. Two kinds of cement may be present in the same rock.

Durability of cement. — Other things being equal, silica forms the most durable kind of cement in rocks exposed to the chemical action of the atmosphere; iron oxide is next, and calcium carbonate the least durable. Clay, if present in small amounts and evenly distributed, probably does no harm and facilitates the working qualities of the stone, but if very abundant it tends to attract moisture to the rock and lowers its frost resistance.

Structure of sedimentary rocks. — Most sedimentary rocks are characterized by a more or less pronounced bedded structure (Plate XI), known as *bedding* or *stratification* (called *lamination* in the finer sediments), which represent the lines of parting between individual beds or strata, resulting from the sorting action of water,

¹ Berkey, Sch. of M. Quart., XXIX, p. 140, 1908.

and consequently disposed in sheet-like form. The sediment is deposited in layers, usually horizontally or nearly so, and in superposition, and the process of sedimentation may be more or less rapid, or gradual and protracted. The layers may vary as to kind of material, color, texture, and thickness. Variation in thickness of individual layers may range from a very small fraction of an inch up to 100 feet and more, hence we distinguish *beds* or *layers*, and *laminæ* (Fig. 65). The terms *bed* and *layer* as generally used are synonymous and refer to the thicker divisions, while *laminæ* are applied to the thinner ones. *Stratum* is generally applied to a single bed or layer of rock, while a group of beds deposited in sequence one above another and during the same period of geologic time is known as a *formation*. The thickness of the individual layers affects the value of the rock for building stone, as well as its stability and strength in tunnel construction, etc.

Composition of sedimentary rocks.—Mineralogically, the sedimentary rocks are in general more simple than most of the igneous ones. Fewer minerals, of less complex composition chemically, and as a rule of more stable character, enter as the principal components of the sedimentary rocks. This follows naturally for the reason that the sediments are composed principally of those minerals derived by the processes of sedimentation from igneous rocks able to resist the various changes to which they have been subjected, together with recombinations to form new minerals of a less complex and more stable character, under surface conditions. The most common minerals entering into the composition of sedimentary rocks are quartz, kaolinite, feldspar, mica, and the iron oxides, both hydrous and anhydrous, together with those precipitated from solution, such as the carbonates (calcite, dolomite, and siderite), and the sulphates, gypsum and, to a less extent, anhydrite, as well as a few less commonly-occurring ones.

Chemically the sedimentary rocks are subject to greater variations in composition than the igneous masses, owing to the nature of the processes involved in their genesis. Composite analyses of sedimentary rocks as averaged and tabulated by Clarke are as in table on following page.

CLASSIFICATION OF SEDIMENTARY ROCKS

The classification of sedimentary rocks best suited to the needs of the engineer, and the one that is adopted in this book, is based (a) on mode of formation or genesis, and (b) on composition and physical

COMPOSITE ANALYSES OF SEDIMENTARY ROCKS

	I.	II.	III.
SiO ₂	58.38	78.66	5.19
Al ₂ O ₃	15.47	4.78	0.81
Fe ₂ O ₃	4.03	1.08	} 0.54
FeO.....	2.46	0.30	
MgO.....	2.45	1.17	7.90
CaO.....	3.12	5.52	42.61
Na ₂ O.....	1.31	0.45	0.05
K ₂ O.....	3.25	1.32	0.33
H ₂ O at 110°.....	1.34	0.31	0.21
H ₂ O above 110°.....	3.68	1.33	0.56
TiO ₂	0.65	0.25	0.06
CO ₂	2.64	5.04	41.58
P ₂ O ₅	0.17	0.08	0.04
S.....	0.09
SO ₂	0.65	0.07	0.05
Cl.....	Trace	0.02
BaO.....	0.05	0.05	None
SrO.....	None	None	None
MnO.....	Trace	Trace	0.05
Li ₂ O.....	Trace	Trace	Trace
C, organic.....	0.81
	100.46	100.41	100.09

I. Composite analysis of 78 shales; or, more strictly, the average of two smaller composites, properly weighted. II. Composite analysis of 253 sandstones. III. Composite analysis of 345 limestones.

When sedimentary rocks are used for building purposes the chemical analysis is as a rule of little value, but for some other uses it is important.

characters. The one tabulated below is, in most essentials, that given by Pirsson.¹ It follows:

I. Sediments of mechanical origin.

1. Water deposits.
 - a. Conglomerates and breccias.
 - b. Sandstones.
 - c. Shales.
2. Wind deposits.
 - a. Loess.
 - b. Sand dunes.

II. Sediments of chemical origin formed from solution.

1. Concentration.
 - a. Sulphates: Gypsum and anhydrite.
 - b. Chlorides: Halite (rock salt).
 - c. Silica: Flint, geyselite, etc.
 - d. Carbonates: Limestone, travertine, etc.
 - e. Oxides: Iron ores.

¹ *Rocks and Rock Minerals*, 1908, p. 291.

2. Organic, formed through the agency of animals and plants.
 - a. Carbonates: Limestone of several kinds.
 - b. Silica: Flint, diatomaceous earth, etc.
 - c. Phosphate: Phosphate rock.
 - d. Carbon: Coal, etc.

From the very nature of sedimentary processes the principal kinds of sediments tabulated above grade into each other, and frequently it is difficult, if indeed not impossible, to determine whether a particular rock should be classified in one division or in another.

I. SEDIMENTARY ROCKS OF MECHANICAL ORIGIN

The rocks included under this head have resulted mainly from the mechanical action of water or sometimes wind action, and are therefore stratified, that is, arranged in layers or beds. With few exceptions, which will be specifically mentioned, they represent the land waste derived by weathering of pre-existing rocks, transported and deposited by moving waters and subsequently consolidated. Because they are composed of fragments of pre-existing rocks they are sometimes referred to as *fragmental* or *clastic* sediments. In composition they are chiefly siliceous and argillaceous, sometimes calcareous. In texture they vary greatly from very coarse to very fine-grained rocks, and may frequently contain fossils — remains of animals and plants. They may be described below under (a) *breccias*, (b) *conglomerates*, (c) *sandstones*, and (d) *shales*.

Breccias

Breccias are composed of angular instead of rounded fragments, cemented together into solid masses (Fig. 61). They are not, strictly speaking, water-laid rocks, as is shown by the angular character of the fragments, and usually in a general absence of stratification. When deposited in water, as they sometimes are, the character of the fragments clearly indicates that they have not been moved by running water any distance from their source. They have not all been formed in the same way, hence we usually distinguish, on basis of origin, several different kinds of breccias, which for convenience and not for genetic reasons are given below:

(1) *Talus breccias*,¹ composed of the angular material (Fig. 63), derived by physical weathering, which accumulates at the base of

¹ See further regarding these under Weathering, Chapter IV, and Landslides, Chapter VII.

cliffs (Plate IX, Fig. 2), and sometimes becomes cemented from the action of circulating waters. (2) *Friction* or *fault* (Fig. 64) breccias, formed of angular material derived from earth-movements which

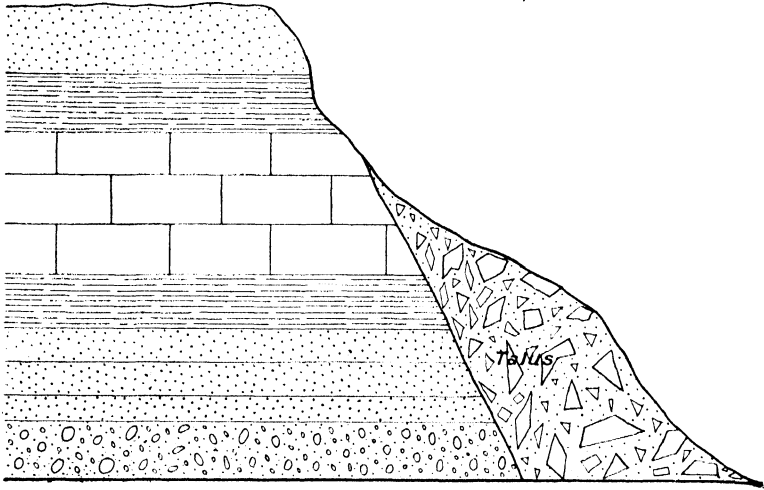

FIG. 63. — Section of cliff, illustrating talus slope at base. By cementation the talus is converted into breccia.

crush and break up the rock on the two sides of a fault by rubbing of the walls against each other, or by intense crushing (Plate IX, Fig. 1) incident to folding. The coarse and fine angular fragments so

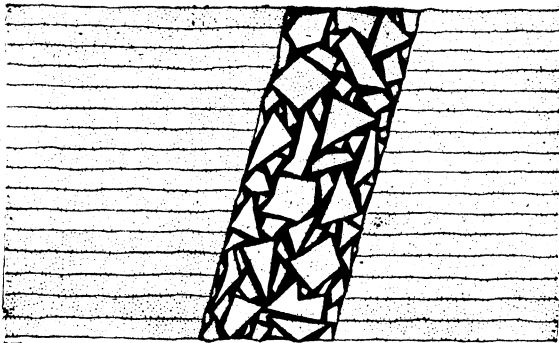

FIG. 64. — Section showing a fault breccia.

derived are often cemented together by deposition from circulating waters. Of the substances deposited in the interstices of the rock fragments and which serve to bind them together, calcite or dolomite, and quartz, are probably the commonest. Sometimes ore-minerals

are deposited by the circulating waters along with the common non-metallic ones, which give rise to breccia-ore deposits, such as the zinc deposits of southwest Virginia and east Tennessee (see Chapter XVII). (3) *Volcanic* or *eruptive* breccias, formed from the coarse and fine angu-

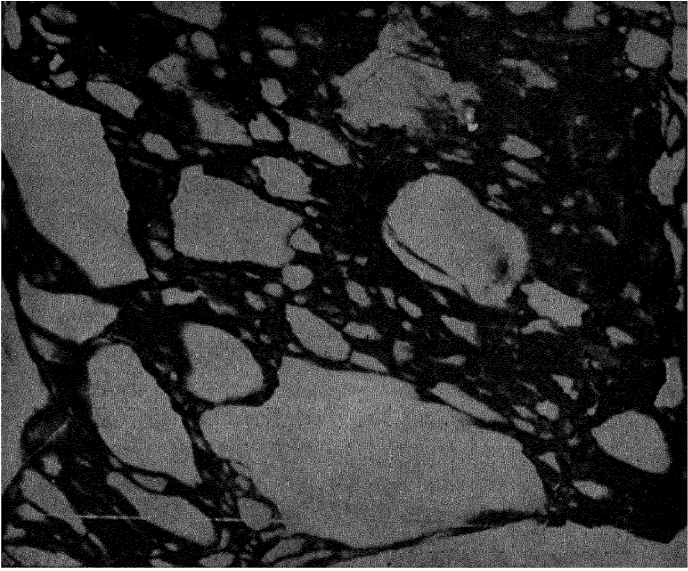

PLATE IX, FIG. 1. — Breccia formed by crushing of marble by rock movements.



FIG. 2. — Talus breccia formed by disintegration of limestone seen in cliffs on right, Lake Louise, Alberta. (J. S. Hook, photo.)

lar material ejected by volcanic action, and afterwards consolidated into solid rock. This last type of breccia if of recent formation is usually very porous. (4) *Fold* breccias, formed by the crushing of rocks during folding. (5) *Solution* breccias, formed, for example, where the lime carbonate of the cherty limestone is removed by solution, the chert fragments gathering together as the mass settles.

The angular fragments composing breccias may vary greatly in size, ranging from large irregular-shaped blocks down to rock particles just large enough to be readily distinguished by the naked eye; and these different sized materials may be and usually are heterogeneously mixed. The fragments may all be derived from a single rock type—igneous, sedimentary, or metamorphic—or from several dissimilar types. When derived from a single kind of rock, the breccia may be designated by the name of the original material, as *limestone* or *marble breccia*, *sandstone*, or *quartzite breccia*, *gneiss breccia*, etc.

Breccias may show a wide range of color, due partly to kind and color of the rock fragments and partly to the character and amount of the cement. They have not been used to any extent as a stone for building purposes, chiefly because of their heterogeneous character and appearance, but some of the more compact varieties which are susceptible of a polish are of great ornamental value, such as some of the brecciated marbles (Plate IX, Fig. 1). These, however, are often lacking in durability and may be of very irregular hardness. (For properties and uses of breccias as decorative or ornamental stone, see Chapter on Building Stone.)

Conglomerate

Conglomerates are composed of rounded and water-worn material of different sizes (Plate X, Fig. 2), ranging up to large boulders, cemented together into solid rock (Fig. 62). The compact pebbles are rounded and water-worn from water action. They are usually made up of the more resistant varieties of minerals and rocks that may have traveled some distance from their original source, and the interstices are commonly filled with fine sediment, such as sand, etc. Among the commonest cements binding the pebbles together are silica, calcite, and iron oxide. The component pebbles may be essentially of a single kind of mineral or rock, or several kinds may be mingled together. Thus, we may have *quartz conglomerate*, *limestone conglomerate*, *quartzite conglomerate*, *gneiss conglomerate*, etc.

The rock pebbles entering into the composition of conglomerates may be derived from original igneous or sedimentary rocks, or their equivalent metamorphic ones. *Volcanic conglomerate* is usually applied to material ejected during igneous activity that has fallen into water and become rounded and cemented into solid rock.

Like breccias, conglomerates are subject to a wide range of color, and texturally present a heterogeneous appearance. The ratio of cement to pebbles is very variable. Those showing much cement and with sharp contrast between it and the pebbles have received the name *pudding stone*. Conglomerates grade into sandstones and nearly all gradations between the two may be observed.

Conglomerates are entirely aqueous in origin and usually exhibit more or less characteristic stratified or bedded structure, which is apt to be less distinct in the coarser types. They are deposited in shallow water close into shore, and represent either coarse material dropped by a stream, or the products of wave action along the shore. When forming extensive areas they usually indicate an advance of the sea over the land, and they become important guides to the geologist in the interpretation of past geological conditions, such as unconformities, etc. They usually mark the lower member of a sedimentary series, and are of widespread occurrence among sedimentary rocks.

Some conglomerates may furnish durable building material, and in some localities, especially in the vicinity of Boston, they have had a limited use, but on account of their heterogeneous character and general coarseness, they have not been employed to any extent either as a building or ornamental stone. The harder and denser conglomerates have sometimes been used for making millstones.

Sandstone

Composition and texture.— Sandstones are sedimentary rocks composed of grains of sand¹ bound together by a cementing material. Many sandstones contain little if any cement, but owe their tenacity to the pressure to which they were subjected at the time of their consolidation (Merrill). The component grains of sandstone are chiefly quartz, but many other minerals occur, such as feldspar, mica, garnet, magnetite, etc. Size of the individual grains varies within rather wide limits, the coarser-grained sandstones passing into conglomerates on the one hand, and the finer-grained ones into shales on the other. The sand particles of the fine-grained rocks are commonly angular or subangular, but are usually well-rounded from water action in the coarser ones.

¹ Grains mostly siliceous in character.

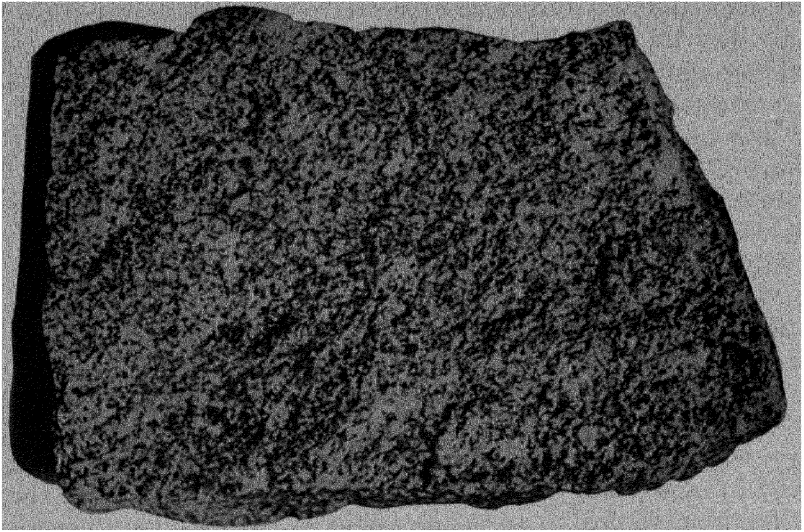

PLATE X, FIG. 1. — Medium-grained sandstone.

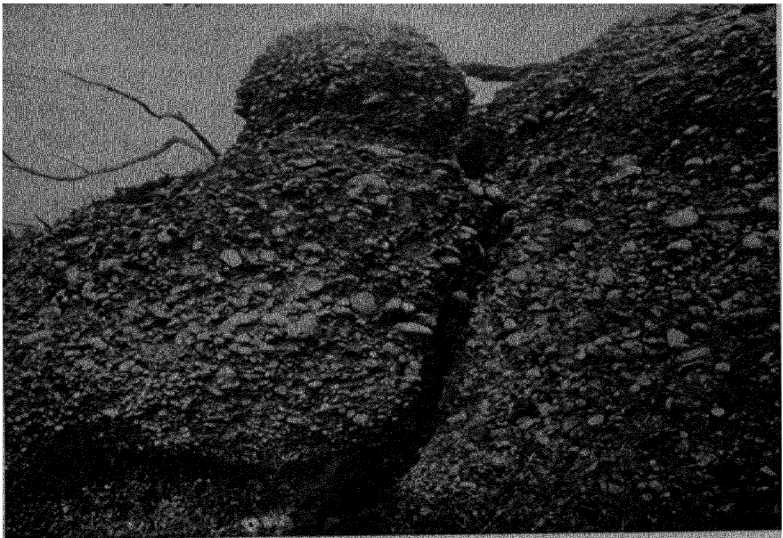

FIG. 2. — Coarse conglomerate with little cement, Frank, Alberta.
(H. Rics, photo.)

Color. — Sandstones exhibit a variety of color, the various shades of gray, white to buff, brown, and red being the most common. Likewise, the cementing materials in sandstones, as in conglomerates, vary, being usually silica, iron oxide, calcite, or clay, but sometimes minerals of secondary character (p. 97). The color of the rock and its adaptability depend more perhaps upon the character of the cementing material than upon the individual grains. If silica alone is present the rock is light-colored, hard, and among the most durable, but difficult to work. When the cementing substance is iron oxide the rock is some shade of red, brown, or yellow, and usually works readily. A calcium carbonate cement produces a light-colored rock, nearly white or some shade of gray in color, generally softer, less resistant to the weather, but easy to work. Clay cement if abundant is objectionable because of the readiness with which it absorbs water, rendering the rock subject to injury by frost. The color of the sandstone is often one of the factors governing its use as a building stone.

Porosity. — The porosity of a sandstone is a matter of practical importance for several reasons. High porosity may mean high absorption and high permeability. A very porous sandstone might therefore be regarded as unsuitable for dam construction or for use in moist situations. If the absorbed water completely fills the pores there is then danger of the stone disintegrating when exposed to repeated freezing.

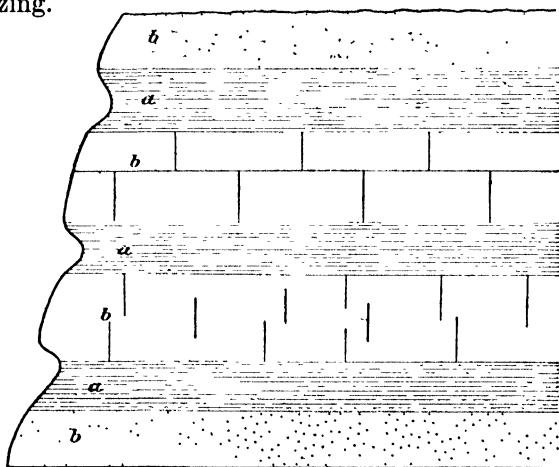

FIG. 65. — Section showing stratification and lamination; (a) laminated beds.

Porous sandstones under favorable structural conditions often serve as reservoirs for artesian water (Chap. VI), and for oil and gas.

Structure. — Aqueous sandstones are deposited in beds or layers of varying thicknesses and may be referred to as thin-bedded or thick-bedded. In many sandstones laid down in shallow water, rapid changes in currents or eddies produce cross-bedded structure (Fig. 66).

Varieties of sandstone. — Many varieties of sandstone are recognized, based chiefly upon character of cementing material, composition, structure, etc. Named according to the character of cement which binds the grains together we may recognize *siliceous* sandstones, *ferrous* sandstones, *calcareous* sandstones, and *clayey* or *argillaceous* sandstones. Other varieties are: *Arkose*, a sandstone containing much feldspar; sometimes called *feldspathic* sandstone, derived from weathering of feldspathic rocks, especially granite, the products having

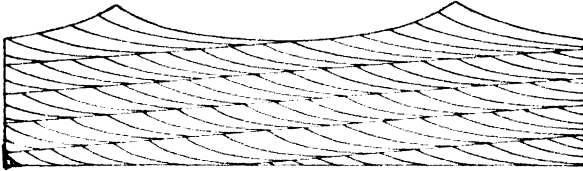

Fig. 66. — Section illustrating cross-bedding.

been moved only short distances. *Graywacke*, a compact, usually gray sandstone (fine conglomerate) composed of rounded or angular fragments of various kinds of rocks in addition to quartz and feldspar. *Grit*, a term sometimes applied to coarse sandstones composed of angular grains cemented by silica. *Flagstone*,¹ a variety of thin-bedded sandstone which splits readily along the bedding planes into slabs that may be used for flagging. *Freestone*, a variety of sandstone, usually thick-bedded, that works easily or freely in any direction. *Micaceous* sandstone, a variety containing much mica.

In age sandstones range from the Algonkian down to the most recent, but those quarried in this country for building purposes do not include any of later age than Tertiary. Sandstones rank among the most important of natural building materials. For the properties, mode of occurrence, and distribution of sandstones as a constructional stone, the reader is referred to Chapter XI on Building Stone.

In tunneling through sandstone, as well as some other kinds of rock, for water-conveying tunnels, the porosity and jointing of the rock must be considered in order to avoid possible leakage.² In such cases it

¹ See Dickinson, N. Y. State Museum, Bull. 61, 1903.

² In this connection see discussion by Bryan, on Lees Ferry dam in Colorado Canyon, Proc. Amer. Soc. Civ. Engrs., XLVIII, Sept., 1923.

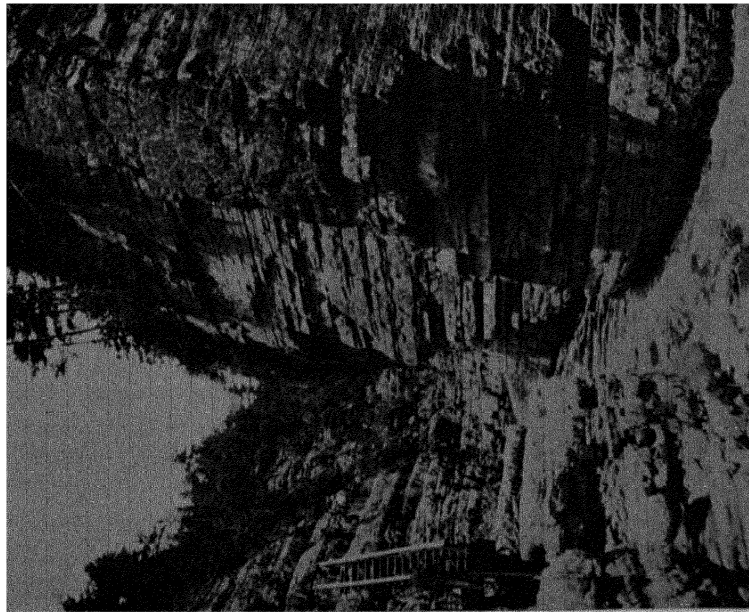

PLATE XI, FIG. 1. — Section in hard sandstone (quartzite), showing horizontal stratification. Ausable Chasm, N. Y. (H. Ries, photo.)

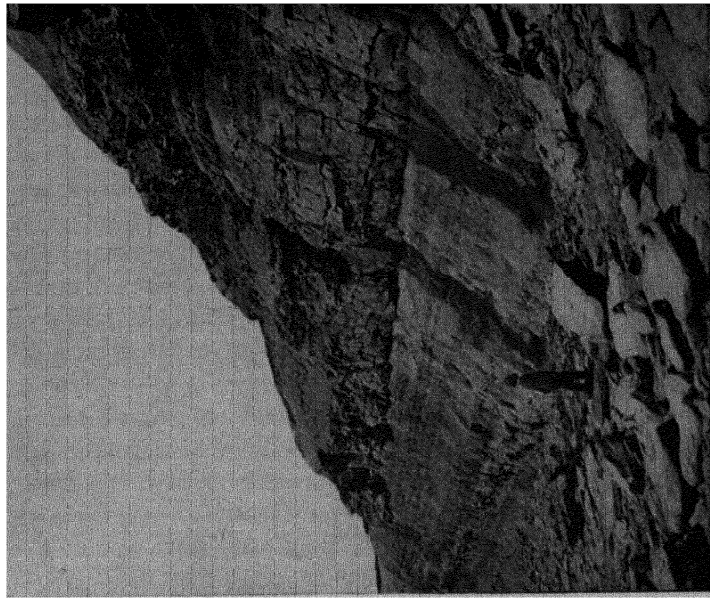

FIG. 2. — Beds of gently dipping shale, overlain by hard, much-jointed sandstone. The boundary line is very distinct. Sydney, N. S. (H. Ries, photo.) (109)

sometimes becomes necessary to line the bottom and to some extent the sides of the tunnel with cement or mortar to make it water tight. Failure to observe such precautions may result in serious consequences.

Shale

Shales are compacted clays, muds, or silts that possess a finely stratified or laminated structure (Plate XI, Fig. 2). The structure is true stratification or bedding which has resulted from deposition of the finely-divided material in water. Because of being composed of the finest particles of land waste they are capable of being split into very thin leaves; and for the same reason the component minerals of shales cannot be determined with the unaided eye.

Shales exhibit a great variety of colors, gray, buff, yellow, red, brown, purple, and green to black, being frequently observed. They are usually soft and brittle rocks, which crumble readily under the hammer. They may grade into clays on the one hand, and into fine-grained sandstones when siliceous, into thin-bedded limestones when calcareous, into some kinds of coal when carbonaceous, etc., on the other. When metamorphosed they may pass into slates and schists.

Many varieties of shales are recognized, the distinction being founded chiefly on composition. Thus, we may have *argillaceous* or *clay* (*aluminous*) shales, *arenaceous*, *sandy*, or *siliceous* shales, *calcareous* shales, *ferruginous* shales, *carbonaceous* or *bituminous* shales, etc.

According to Clarke, shale is the most abundant of the three principal kinds of sedimentary rocks, their values being rated as follows: Shales 4 per cent, sandstones 0.75 per cent, and limestones 0.25 per cent.

Shales are not as strong as sandstones or hard limestones, and for this reason, if unsupported or enclosed, they yield to the pressure of overlying rocks. This is occasionally noticed in coal mines, where after the removal of the coal the shale rock of the floor and roof sometimes squeeze together. For the same reasons, shale rocks which have been crushed and fractured by earth movements may yield to the pressure of the surrounding rocks, so that the fractures become healed or closed up, and there is less chance for the circulation of underground waters. This fact must be considered in the construction of aqueduct tunnels to avoid danger from leakage.

Shales, because of their thinly-bedded character, sometimes cause trouble in tunneling, the material becoming dislodged quite easily.

They are of no value as building stone, but often find extended use

in the manufacture of brick, tile, and pottery, and of Portland cement. (See Chapters XII and XIII.)

Clays. — These resemble shales chemically, and in most cases are of sedimentary origin. The typical ones are unconsolidated, but they grade into shales. Their uses and general characters are discussed in detail in Chapter XIII.

Variation in shale and sandstone deposits. — Shales when followed along the bed sometimes grade into sandstones and *vice versa*, moreover the two kinds of rock may alternate, sometimes in rapid succession. Plate XI, Fig. 2, shows a heavy sandstone bed underlain and overlain by shale. There are, however, many localities in which large deposits of either shale or sandstone alone are found.

The possibility of variation in sedimentary rocks, especially shales and sandstones, is an important point for engineers to bear in mind, when searching for a convenient site to open a quarry for road material or dimension stone.

The case of the Ashokan dam referred to above can again be taken to illustrate our point. The dam is located in a region of sedimentary rocks consisting of sandstones and shales. The former are in part thinly bedded and used for flagstones, and many quarries have been opened up in the thinly bedded or "reedy" rock. In other parts of the formation in the same district more massive beds were found, which were suitable for the extraction of dimension blocks. As a matter of practical interest, it may be mentioned that the *reeds* or thin bedding were due to the presence of numerous small sized, elongated grains, lying in a more or less parallel position.¹

WIND (ÆOLIAN) DEPOSITS

Under this head are included only two kinds of material, namely, *loess* and *dune sand*. Probably *loess* should be included here only in part, since it is not agreed by all that wind has been the principal agent involved in the formation of all deposits.

Loess

Loess is the name given to a very fine, homogeneous, silty or clay-like material that is largely siliceous in composition, but contains some calcareous matter, which sometimes forms nodules and small vertical tubes. It is usually characterized by complete absence of

¹ Berkey, Sch. of M. Quart., XXIX., p. 154, 1908.

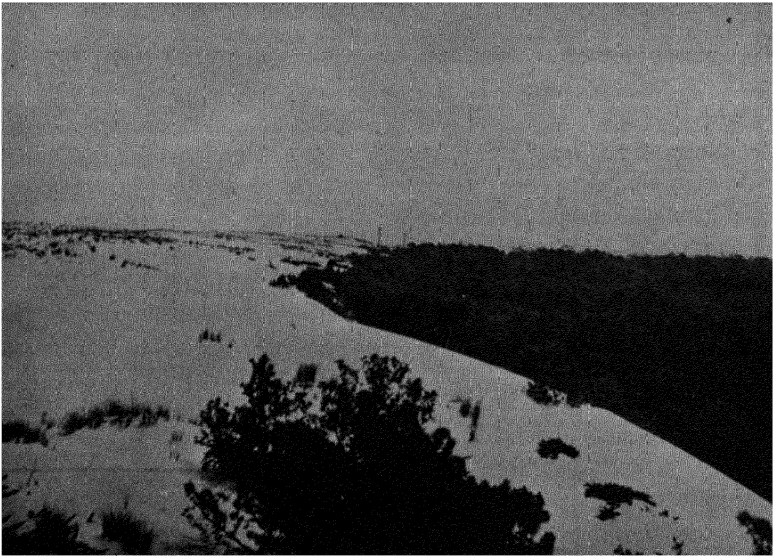

PLATE XII, FIG. 1. — Front slope of advancing sand dune. Shows edge of forest lying in its path, and trees already partly buried. Cape Henry, Va. (H. Ries, photo.)



FIG. 2. — General view of sand-dune area. Shows grass and seedling pines which have been planted to stop the drifting sand. Baltic coast of Germany. (H. Ries, photo.)

stratification, but cleaves vertically, so that when eroded it forms very steep precipitous cliffs. It is composed chiefly of clay-like material and angular grains of quartz, tiny flakes of mica, and more or less carbonate of lime, which has been reported in some cases to reach 30 per cent in amount.

Loess covers vast areas in many parts of the world, reaching a thickness of hundreds of feet in some cases, and for this reason is of some importance to the engineer. Some of the larger and more important areas of loess include the Mississippi Valley in the United States, the valleys of the Rhine and its tributaries in Europe, and northern central China in Asia. In origin it is claimed by some to be æolian, by others to be fluvatile or lacustrine, and by still others to be partly æolian and partly aqueous (Chamberlin and Salisbury). The loess is utilized in some parts of the West for common brick manufacture, but the product is not always satisfactory. When exposed to rainstorms the loess often gullies very badly.

A similar fine clayey material, accumulated in basins and on the plains of the arid regions of the western United States, probably formed partly by wash and partly by wind action on the neighboring slopes, has been called *adobe*, which has been used in the form of sun-dried brick for building, and when irrigated forms a productive soil.

Sand Dunes

In arid and semi-arid regions, and in humid regions where the loose sand is not protected by vegetation, especially the beaches of sea and lake shores, the sand is piled up by the driving action of the wind into mounds and ridges called *dunes* (Pl. XII, Figs. 1 and 2). The sand particles are lifted only a slight distance above the land surface, hence their movement is often interfered with by surface obstacles, such as a tree, shrub, building, fence, etc., which results in deposition and accumulation. The ridges commonly lie transverse to the direction of the wind, but may sometimes be longitudinal or parallel as illustrated by the dunes in the desert of north-west India. They are usually not more than 10 or 20 feet high, but sometimes reach heights of 200 or 300 feet.¹

Sand dunes formed on the river flood plains of arid regions, and the desert are often curved or crescent shaped in outline, the convex side being towards the wind and with the horns of the crescent extending in the direction of advance.

¹ As along the shores of Lake Michigan.

Dunes commonly show a long, gentle slope, on the windward side, up which the sand grains can be readily moved, and a steep slope (angle of rest for the sand grains) on the leeward side (Fig. 67). The windward slope may be as low as 10° , while the leeward one may be as steep as 30° . The slopes may be very irregular when the dunes are partly covered by vegetation. Dunes migrate by the transfer of sand from their windward to their leeward side, and may invade forests and fertile fields, and even bury villages, which may result in either case in

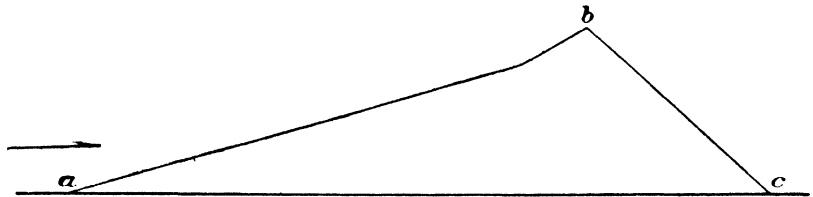

Fig. 67. — Section of a dune showing long, gentle, windward slope (*ab*) and steeper leeward slope (*bc*).

much loss. In some cases an advance of as much as 100 feet per year has been recorded. Where dunes have been formed on barrier beaches (Chap. VIII), as along the Atlantic coast of the United States, the shifting sand may advance over the salt meadows which have formed in the lagoons behind the beach. Planting of vegetation on dunes to prevent their encroachment on areas is resorted to in some countries and is probably the simplest method by which migration may be stopped.

Wind-blown sands, like water deposits, are stratified, since they are transported and deposited by air currents of varying velocities, the size of sand grain moved being dependent upon the strength of current. The sand also shows a cross-bedded structure. Some sandstone formations which are fine-grained and exhibit cross-bedding over wide areas are evidently ancient eolian deposits.

The composition of the sand varies, but is usually siliceous, sometimes calcareous as in the Bahamas and Bermudas. Many of the calcareous sands of the Bermudas, through partial solution and redeposition of the lime by percolating waters, are cemented into solid rock of considerable extent. In New Mexico there are extensive dune areas composed of gypsum sand.

Dunes are not confined to arid regions, but are likely to be developed wherever loose sand is exposed to the wind, such as the sandy shores of lakes and seas, in sandy valleys and even along rivers.

Distribution.¹ — Sand dunes are abundant along many parts of the Atlantic and Pacific coasts, along the shores of the Great Lakes, and in many parts of the arid regions of the west. They are not unknown in some of the sandy inland areas of the United States.

Wherever found they are often a source of trouble if the region is an inhabited one, as in their march across the country they bury houses, forests, orchards, railroads or anything in their path. Along the Oregon Railway and Navigation Company, the sand which drifts across the tracks near the Dalles, Ore., has to be removed daily.

The practice of "fixing" dunes, to prevent troubles such as those mentioned, is a problem for engineers and others, which has been but little dealt with in some parts of the United States, although it has gone on in Europe for more than 50 years.

The preliminary methods used for "fixing" the dunes are: (1) Transplanting with beach grass; (2) covering with heather; and (3) covering with a network of sand hedges. Any one of these methods serves to hold the sand temporarily, after which young trees, usually conifers, are transplanted, and the danger of shifting is soon removed.

Some railroads have adopted the plan of temporarily fixing the dunes by spraying them with crude oil.

II. SEDIMENTS OF CHEMICAL ORIGIN FORMED FROM SOLUTION

Under this head is included a series of deposits which owe their origin to processes that are chemical in character, and formed chiefly by concentration through evaporation of aqueous solutions, changes of temperature, loss of carbon dioxide, etc., aided more or less in some cases by the action of organic life (plants and animals), and resulting in the precipitation of insoluble salts.

Sulphates: Gypsum and Anhydrite

Gypsum and anhydrite, the hydrous and anhydrous sulphates of lime, have been described as minerals on pages 37 to 39. Since they are usually intimately associated in origin and mode of occurrence they can be discussed together. They may be readily distinguished from each other by the common megascopic properties described under each mineral in Chapter I.

Gypsum and anhydrite may occur as separate and independent masses, but are often found in the same deposit in those regions where anhydrite is abundant, when their association is frequently irregular and puzzling. Under such conditions the two are found

¹ Hitchcock, *Nat. Geog. Mag.*, XV, p. 43, 1904; Kellogg, *Cal. Jour. Tech.*, III, p. 156, 1904; Stuntz and Free, *U. S. Bur. Soils, Bull.* 68, 1911.

interbedded, or in irregular masses, or the one may form veins traversing the other. Under certain conditions each may be transformed into the other. In their most extensive and important occurrences, they form beds or lenticular sheets and masses, interstratified usually with clays, shales, sandstones, and limestones, and in some regions are often associated with rock salt.

Large deposits of gypsum and anhydrite are known at a number of localities in the United States and Canada. The former is used for plaster, and its applications are discussed in Chapter XII, but the latter is of little or no commercial importance. They have been formed on a large scale from concentration of oceanic waters by evaporation and in inland lakes in which evaporation equals or exceeds the amount of inflow. Less extensive deposits are formed in other ways.

In some regions, the solubility of the gypsum produces a hummocky topography and even sink holes. The change of anhydrite to gypsum may occur on exposure of the former to moisture, and in Europe at least one case is known where a tunnel was driven through a deposit of anhydrite and thrown out of alignment caused by the swelling of the material when changed to gypsum, the alteration being brought about by trickling water.

Chlorides: Rock Salt

The mineral halite (NaCl) occurs in many localities in massive granular form as beds of rock salt of varying thickness, interstratified with clay, marl, and sandstones, usually associated with gypsum, anhydrite, and dolomite. The celebrated salt deposits of Stassfurt, Germany, associated with gypsum, anhydrite, and the chlorides and sulphates of potassium and magnesium, are the most extensive in the world, having a known thickness of 4000 feet. Beds of rock salt are known in the United States, in New York, Kansas, Michigan, Louisiana, Virginia, and many other states. The formation of rock salt has in many cases been similar to that of gypsum. Some of the principal deposits owe their origin to the evaporation of arms of the sea cut off from the main body of water, and to the desiccation of inland lakes, but may be formed in other ways.

Salt deposits are of no special importance to the engineer. Owing to their ready solubility they are rarely found outcropping on the surface except in arid regions. Their presence is sometimes noted in another way, because surface waters in some regions may show an abnormal chlorine content caused by rock drainage from salt-bearing formations entering surface streams. Saline water in a deep well, however, does not necessarily indicate the presence of salt beds, but salt springs and seeps may be significant.

Siliceous Deposits

Under siliceous materials are included those deposits of silica (SiO_2), which form by deposition from evaporation of aqueous solutions, and by the action of organic life. Some may form at times as the result

of direct chemical reactions. The deposits so formed have not the widespread occurrence and importance as sediments formed by other processes, but are sometimes of considerable interest locally. Those included under this head are *flint*, *siliceous sinter* (*geyserite*), and *diatomaceous earth*.

Flint. — Flint, known also as *chert* and *hornstone*, has been referred to as a variety of quartz in Chapter I. It is a hard, dark gray to black rock, breaking with conchoidal fracture, and composed of amorphous or chalcedonic silica. Its dark color is due to carbonaceous matter, which disappears on strong heating, and it is translucent on thin edges, resembling many felsites of igneous origin. Chert occurs chiefly as nodules, layers or lenses in chalk and limestone (Plate XIII, Fig. 2). In the United States it is especially common in the Cambro-Ordovician limestones of magnesian composition along the Appalachian region, and is also found in other limestones. The disadvantages of chert in building stone are referred to in Chapter XI. The chert used in ball and tube mills is obtained from the chalk formations of Germany, England, etc.

Jasper, a ferruginous opaline silica, occurring as large masses in the iron ore formations of the Lake Superior region and known as *jaspilite*, is also a variety of flint, and the *novaculite*, occurring in extensive beds in Arkansas, and used in the manufacture of whetstones and hones, is still another one. Its origin is still a mooted question.

Geyserite. — This, known also as *siliceous sinter*, is a product of amorphous silica deposited from solutions of evaporating hot waters in volcanic regions, and by silica secreting algae. The rock may be loose or unconsolidated and porous, or dense and compact, and when free from impurities, of white color, though sometimes stained shades of yellow and red. It is most extensively developed in the United States in the hot-spring and geyser region of the Yellowstone National Park. At Steamboat Springs, Nevada (Plate XIII, Fig. 1), there are extensive deposits of siliceous sinter which contain traces of antimony and mercury.

Diatomaceous earth. — Diatomaceous earth, known also (but incorrectly) as *infusorial earth* or *tripolite*, is a soft, pulverulent, siliceous clay-like material, very fine and porous in texture, somewhat resembling chalk, bog-lime or kaolin in its physical properties, and of white, yellow, or gray color. It can be readily distinguished from chalk and bog-lime by not effervescing in acid and from kaolin by its distinct gritty feel and lighter weight. It is formed from the shells or tests of certain aquatic microscopic forms of plant life known as diatoms, which have the power of secreting silica in the same manner as mollusks secrete lime carbonate.

Diatomaceous earth occurs in Virginia and Maryland in beds of varying thickness up to 30 feet and more, and in California in deposits several thousand feet thick. It sometimes accumulates in the bottom of ponds and is occasionally mistaken for bog-lime.

Diatomaceous earth is used to a small extent as a polishing powder, as a pack-

ing for insulating heated pipes, and for making refractory brick. When mixed with a small amount of clay it can also be made into hollow blocks for partitions, for which purpose it serves as an insulator against heat and sound.

Ferruginous Rocks (Iron Ores)

The iron ores, including the oxides (hematite, limonite, and magnetite) and the carbonate (*siderite* or *spathic iron ore*, *clay-ironstone*, and *black band ore*), are discussed under Ore-Deposits in Chapter XVII, and are described as minerals in Chapter I. They form the source of iron in the trades, and are only briefly referred to here under rocks.

The iron ores represent a variety of occurrence, and different modes of origin must be attributed to them. In general they may be either of chemical or of organic origin, or partly of both. Variations in properties, mode of occurrence, etc., according to variety, are shown. Further description of these may be had in Chapters I and XVII.

Carbonate Rocks

The group of rocks considered under this head is composed essentially of carbonate of lime, or of this substance with carbonate of magnesia. They vary greatly as to purity, color, and texture; are readily soluble in cold or hot hydrochloric acid; and are easily scratched with the knife, their hardness being under 4. In mode of formation they are partly organically and partly chemically derived rocks. Fragmental calcareous deposits result from the mechanical breaking down of original masses and redeposition of the débris, such as coral sands, etc.

Limestone

This is the most common, important, and widely distributed of the carbonate rocks. It is composed of calcium carbonate of varying degrees of purity (see table of analyses in Chapter XII), the more common impurities being magnesia, silica, clay, iron, and bituminous or organic matter. These may be present in amounts sufficient to give character to the rock, when it may be designated magnesian or dolomitic, siliceous, argillaceous, ferruginous, or bituminous limestone. Limestone usually shows a wide range of color due to the character and amount of impurities present. When pure the rock is white, but the various shades of gray to black are the most common colors, while many others are known. Those of black or dark gray color sometimes fade slightly on prolonged exposure to the atmosphere.

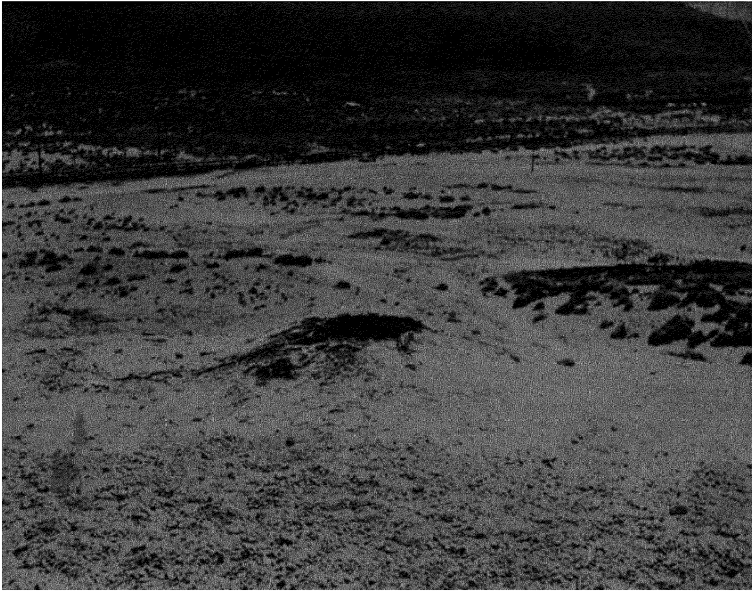

PLATE XIII, FIG. 1. — Deposit of siliceous sinter (white material), Steamboat Springs, Nev. The small cone, which is filled with boiling water, has formed around one of the hot spring vents. (H. Ries, photo.)



FIG. 2. — Cherty limestone, 6 miles west of Lexington, Va. The chert nodules stand out in relief on the weathered surface. (After Bassler, Bull. II-A, Va. Geol. Surv.) (119)

Chemical composition. — The limestones show equally great variation in composition. Magnesium carbonate may be present from traces up to the percentage amount required to form dolomite; and silica may range from a trace up to the limit where the rock becomes a calcareous sandstone. Similar gradations of limestones into calcareous shales occur, according to the amount of clayey material present.

Where a limestone is to be used for lime or cement manufacture, or as a flux in the smelting of ores, its chemical composition needs to be considered. Variation in composition is sometimes found from layer to layer, and an appreciable variation is not always visible to the naked eye. Careful sampling of a limestone quarry for chemical analysis is therefore necessary. A good case of this is to be seen in the Trenton limestone of the Lehigh cement district in eastern Pennsylvania, where analyses of twenty-nine beds aggregating 75 feet in thickness showed percentages of calcium carbonate ranging from 96.60 per cent to 51.30 per cent, and of magnesium carbonate from 1.51 per cent to 22.09 per cent.¹

Physical properties. — The compact calcitic varieties vary in specific gravity from 2.5 to 2.8, effervesce freely in cold dilute acid, and can be readily scratched with a knife.

Variation of limestones in texture, strength, and durability is as great as in composition. They may vary from very fine-grained and compact rocks to those composed of coarse fragments of shells and coral. They are found in beds of all thicknesses up to 100 feet and more. Most of the limestones used for building purposes belong either to the Cambrian, Silurian, Devonian, or Carboniferous horizons. Limestones weather chiefly through solution, the soluble calcium carbonate being removed, and the insoluble material (impurities) left in place to form residual soils (see Chapter IV). The properties, occurrences, and uses of limestone as a building stone are described in Chapter XI.

Solubility.² — The solubility of limestone is not alone a matter to be considered in connection with its resistance to weather, but also in engineering operations where limestone and water are in constant contact.

The question of imperviousness of a limestone may be closely related to its solubility, as has been demonstrated on several occa-

¹ Peck, *Econ. Geol.*, III, p. 43, 1908.

² For other effects of water dissolving limestone see *Weathering*, Chap. IV, *Sub-surface Waters*, Chap. VI, and *Iron Ores*, Chap. XVII.

sions in aqueduct construction. Where an aqueduct has to cross under a valley by a pressure tunnel, more or less loss may take place through the crevices in the rock, but if the rock is a soluble one like limestone, any crevices in it may become enlarged by solution with increasing leakage. This was noticed, for example, in the case of a 3-mile section of the Thirlmere (England) aqueduct, where a local limestone was used for concrete aggregate. A leakage amounting to 1,250,000 imperial gallons per day developed in a year, due to the limestone fragments becoming corroded by the water. Another instance was that of the limestone blocks used in building the old Delaware and Hudson canal, which showed the effect of contact with water. Here the blocks that had been in contact with the water for approximately 35 to 40 years had been etched until the fossils and other cherty constituents stood out from one eighth to one half inch beyond the general surface of the stone, and in some cases pits are an inch deep.¹

Varieties of limestone. — Many varieties of limestone are recognized, based chiefly upon differences of composition, texture, etc. Most of these are used for structural purposes, and this is to be assumed unless otherwise mentioned below.

Dolomite. — The name applied by many to those limestones which approximate the mineral dolomite in composition. Unfortunately the usage is not uniform and any magnesian-rich limestone is referred to under the above name. Between a straight calcic limestone and a pure dolomite, there may occur all gradations. A dolomite is similar in color, texture, and other physical characters to limestone, except that it is slightly harder, somewhat more resistant, because it is less soluble, and does not effervesce except feebly in cold acid. It is not always an original rock, but has sometimes been derived from straight calcic limestones by the substitution of magnesium carbonate for a part of the calcium carbonate — a process known as *dolomitization*. It is also used for flux and lime making.

Bog lime. — A white, powdery, calcareous deposit, precipitated through plant action on the bottom of many ponds, and used in Portland cement manufacture. It is often erroneously called *marl*, a term which properly belongs to a calcareous clay. *Shell marl* is an aggregate of shells of various organisms usually admixed with some clay or sand, and formed either in fresh or salt water.

Chalk. — A soft, porous, fine-grained variety of limestone composed chiefly of the minute shells of foraminifera; and when pure is white, though a variety of colors may be shown owing to the presence of impurities. It forms extensive deposits in France, Germany, and England, but is less abundant in the United States.

¹ Berkey, N. Y. State Museum, Bull. 146, p. 138, 1911.

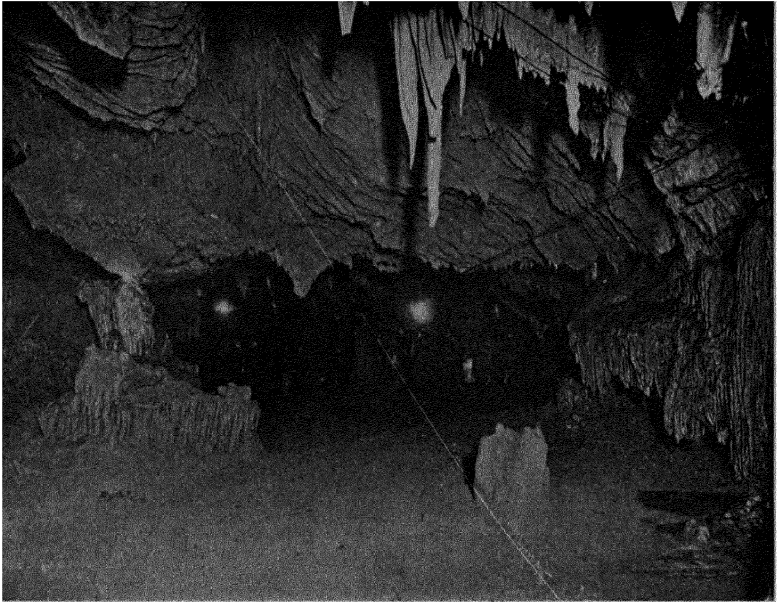

PLATE XIV, FIG. 1. — The Grottoes, Va., showing stalactites of lime carbonate suspended from the roof.

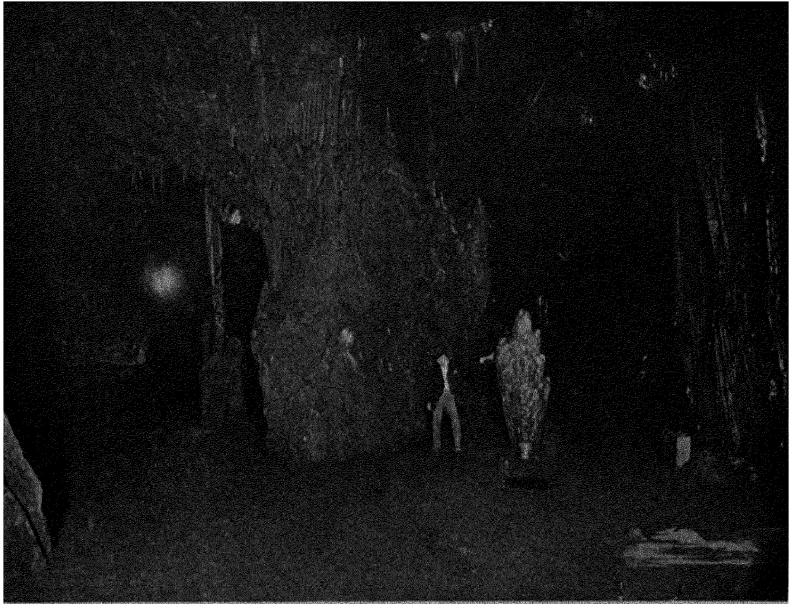

FIG. 2. — Same cave, showing coalescence of stalactites and stalagmites, to form column from roof to floor.
(122)

Chalk is rarely used for structural purposes, but in some regions where it occurs has been used as an ingredient of Portland cement. *Coquina*. — This term is applied to a loosely cemented shell aggregate, like that found near St. Augustine, Fla. The stone does not have a high strength nor is it of good durability if exposed to severe weather conditions. It was used by the Spaniards for constructional work, and in the mild Florida climate has stood well. *Coral rock*. — A calcareous deposit consisting of coral reefs, coral fragments and shells, the entire mass being cemented by lime carbonate. *Hydraulic limestone*. — A clayey limestone, used in cement making, but usually of no value as a building stone. *Lithographic limestone*. — This is a very fine-grained, homogeneous limestone, which because of its peculiar physical properties is of special value for lithographic but not structural work. *Oolite* or *oolitic limestone*. — A variety of the rock made up of small spherical or rounded grains of calcium carbonate, resembling fish roe in appearance, hence the name. When of coarser texture, the term *pisolite* (Plate XV, Fig. 1) is employed. *Travertine*, *calcareous tufa* or *calc sinter*. — A name applied to the less compact, cellular or porous forms of limestone deposited by springs or streams. In this country no deposits of sufficient size for building purposes are known, but the stone is quarried in Italy. Small deposits are common in many parts of the United States, and some interesting ones are found around the Mammoth Hot Springs of the Yellowstone National Park. *Stalactites* and *stalagmites*. — Deposits of compact crystalline limestone, formed respectively on the roof and floors of caves, are forms of travertine (Plate XIV, Figs. 1 and 2). Deposits formed on the floor of sufficiently massive character and extent to be cut are called *cave onyx*, although most of the *onyx marble* of commerce is a spring formation. Limestones may sometimes exhibit more or less conspicuously their fossiliferous character, when they may be named for the chief organic remains in them, such as *crinoidal*, *shell limestone*, etc.

Phosphate Rocks¹

These rocks, composed chiefly of calcium phosphate and known by the general term *phosphoric*, are of great value as a source of phosphoric acid in the manufacture of commercial fertilizers. While not uncommon, extensive beds are very much more limited in distribution than those of the common types of sedimentary rocks. They are of organic origin, formed from animal remains, and in most cases have probably suffered further concentration of the phosphatic material by solution and removal of calcium carbonate from the phosphatic limestone. They may be either compact, earthy, or concretionary, with pebble and nodular forms common. Some shade of gray is the commonest color. Large deposits are found in the United States in Florida, South Carolina, and Tennessee, and in Idaho, Wyoming, and Utah.

Carbonaceous Rocks

Under this group of rocks are included all accumulations of vegetable matter that have undergone partial or complete decay under water. Decay of vegetable matter out of contact with air results in a greater concentration of carbon and removal of the gaseous constituents, as the process advances. The conditions of vegetable

¹ For fuller discussion and bibliography, see Ries, "Economic Geology," 4th ed., 1916.

accumulation and its transformation into coal are explained in Chapter XIV. The different varieties of carbonaceous rocks grade into each other, and there is a well-graded or transitional series from the unaltered plant remains at one end to graphite at the other. The principal varieties usually recognized are *peat*, *lignite* or *brown coal*, *sub-bituminous*, *bituminous*, *semibituminous*, *semianthracite*, and *anthracite* or *hard coal*. The formation, properties, mode of occurrence, distribution, and uses of these varieties are described in Chapter XIV, to which the reader is referred. Coals occur in beds of varying thicknesses interstratified with clays, shales, sandstones, and limestones, and are subject to the same structures as the inclosing rocks. In the United States the coal-bearing formations range in age from Carboniferous to Tertiary. Between the coals and the sandstones and shales, many intermediate types are recognized.

METAMORPHIC ROCKS

Introduction. — The term metamorphic, when broadly applied, includes any kind of change or alteration that any rock has undergone. It involves changes that are both physical and chemical, and the rock so altered may have been originally of sedimentary or igneous origin.

The alteration includes change in mineral composition or texture, or both, and is often so complete as to obscure the primary characters of the original rock, rendering it extremely difficult, if not impossible, in many cases, to say with certainty whether the metamorphic product was derived from an original igneous or sedimentary rock. All gradations exist between sedimentary rocks and their metamorphic equivalents on the one hand, and between igneous rocks and their metamorphic products on the other.

As discussed in Chapter III, the alteration of rocks may be a deep-seated change or a superficial one, the resulting products in the two cases being widely different. The alteration of rocks by atmospheric agents, known as *weathering* and therefore superficial, is discussed in Chapter IV, so that what follows here applies to rocks altered only under deep-seated conditions.

Agents of metamorphism. — The principal agents involved in the alteration of igneous and sedimentary rocks and the production of their metamorphic equivalents are: (1) Earth movements and pressure; (2) liquids and gases, chiefly water; and (3) heat. The effect of the first is mechanical; of the second and third, chemical,



PLATE XV, FIG. 1. — Pisolitic structure.

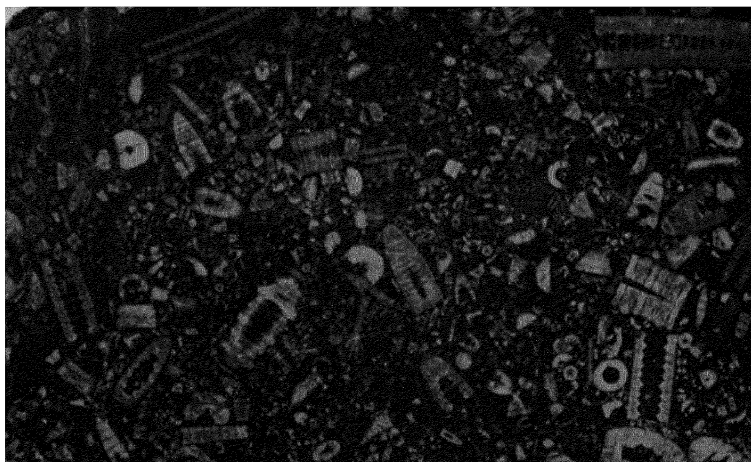

FIG. 2. — Fossiliferous limestone, showing longitudinal and transverse sections of crinoid stems.

usually indicated by the production of new minerals. These are discussed under Metamorphism in Chapter III.

Chemical composition of metamorphic rocks.—The chemical composition of metamorphic rocks varies greatly, because of the wide variations in composition of the numerous types among igneous and sedimentary rocks yielding, when altered, metamorphic ones. The chemical composition of many rocks is not greatly changed during the process of metamorphism; hence, metamorphosed igneous and sedimentary rocks frequently show the composition characteristic of their class. Thus, as remarked by Van Hise, “the metamorphosed sedimentary rocks, with minor modifications, have the chemical composition of muds, grits, sandstones, etc.; the metamorphosed igneous rocks have the composition of granites, diorites, etc.” Chemical analysis therefore frequently forms an important criterion for discriminating between metamorphosed sedimentary and igneous rocks.

Mineral composition of metamorphic rocks.—Mineral composition is dependent on chemical composition, and hence, in metamorphic rocks, is subject to wide variation. It has been shown that certain minerals, such as the feldspathoids (nepheline and sodalite), are characteristic of igneous rocks. Likewise, there are certain minerals which are considered to be characteristic of metamorphic rocks, such as staurolite, cyanite, sillimanite, zoisite, chlorite, talc, etc. Again there are minerals which are common to both groups of rocks, such as quartz, feldspar, mica, amphibole, pyroxene, etc. The mica, amphibole and pyroxene groups contain many species of minerals (Chapter I) some of which are found in igneous rocks, others in metamorphic ones, while still others may occur in both groups.

Staurolite, andalusite, sillimanite, and cyanite are usually considered to be characteristic of metamorphic rocks that are of sedimentary origin.

Texture and structure of metamorphic rocks.—Texturally, the metamorphic rocks resemble most the igneous ones, in being crystalline, and hence they are sometimes referred to as crystalline schists, gneisses, etc.

Metamorphic rocks frequently exhibit conspicuously developed minerals in size, distributed through a groundmass of smaller minerals, closely resembling the porphyritic texture of igneous rocks. Since it can be often shown that these strongly developed minerals are the result of metamorphic processes subsequent to the formation of the original rock, they are conveniently referred to as *pseudo-pheno-*

crysts (*metacrysts*), and the metamorphic rocks containing them as *pseudo-porphyrific* in texture. This texture should not be confused with the *augen* (eye) texture, which is also porphyritic in appearance but represents remnants of the original texture, such as phenocrysts of some igneous rocks, or pebbles of conglomerates, etc.

Metamorphism as explained in Chapter III frequently results in the production of a secondary structure in rocks known as *foliation* (rock cleavage) which resembles more or less closely bedding or stratification planes in sedimentary rocks. Hence metamorphic rocks resemble sedimentary ones in structure, and at times some igneous rocks, for a similar primary structure is often shown in lavas and to some extent in plutonic types. Bastin has suggested the term "*foliated*" as a convenient, comprehensive one to include all rocks showing foliated structure other than bedding planes.

The foliated structure in metamorphic rocks, due to the parallel arrangement of the constituent minerals, is entirely secondary, and is not connected with bedding in sediments, although the two may coincide at times. The terms bedding and stratification, therefore, should not be applied to foliation in metamorphic rocks.

Varieties of structure.—We may recognize the following three principal structures in metamorphic rocks: (1) *Banded* (Plate XVII, Fig. 1), in which lithologically unlike layers of minerals arranged in more or less parallel bands are shown, as in gneisses; (2) *Schistose*, representing the development of a rather evenly foliated structure, as a result of which the rock often splits easily, but not always very regularly, as in schists; and (3) *Slaty* (Fig. 68), in which the mineral grains are very small, and the rock dense, but having the property of splitting (slaty cleavage) into thin, even slabs. Gradations between any two may occur. Thus a schistose rock may pass into a banded one by the like mineral grains becoming more segregated into definite bands, or it may on the other hand grade into a slaty structure by the grains becoming finer and more uniform.

Criteria for the discrimination of metamorphosed igneous and sedimentary rocks.—In the study of a metamorphic rock, it is desirable but not always easy, to determine whether the rock was derived from an original igneous or sedimentary one. The evidence upon which the geologist depends is gained partly from careful field study of the mode of occurrence, general characteristics and relationships of the rocks, and partly from both microscopical and chemical laboratory study, of rock specimens collected in the field.

In those cases where metamorphism has not been extreme, the

original texture and structure of the igneous and sedimentary rocks have not been completely obscured, and the discrimination of the derived rock is not so difficult. In many cases, however, the metamorphism has been so complete as to entirely obliterate all trace of the general character of the original rock, and discrimination becomes extremely difficult. Various criteria have been proposed in such cases, but probably chemical analysis forms one of the most important. From the chemical standpoint Bastin has summarized the evidence as follows:

I. Dominance of MgO over CaO is strongly indicative of sedimentary origin.

II. Dominance of K₂O over Na₂O is of lesser critical value, but is nevertheless suggestive of sedimentary origin.

III. The presence of any considerable excess of Al₂O₃ in the analysis over and above the 1 : 1 ratio necessary to satisfy the lime and alkalis is also suggestive of sedimentary origin.

IV. High silica content may be indicative of sedimentary origin when supported by other criteria. This criterion must, however, be used with caution, since silicification probably takes place in the dynamic metamorphism of certain igneous rocks.

V. When three or all of the above relationships hold good, the evidence of sedimentary origin may be regarded as practically conclusive.

Mineral composition often becomes an important criterion in distinguishing metamorphosed sedimentary from metamorphosed igneous rocks, as indicated under these heads, above.

Classification of Metamorphic Rocks

Since in most cases it is not possible on megascopic grounds to group metamorphic rocks according to origin, whether derived from original sedimentary or original igneous masses, some other basis of classification that is practical must be sought. Probably the classification of metamorphic rocks which best meets the needs of the engineer, and the one followed in this book, is based chiefly on mineral composition, texture, and structure. It follows.

CLASSIFICATION OF METAMORPHIC ROCKS

- I. Gneisses of various kinds.
- II. Crystalline schists of various kinds.
- III. Quartzites.
- IV. Slates and phyllites.
- V. Crystalline limestones and dolomites (marbles).
- VI. Opicalcites, serpentines, and soapstones.

Other kinds of metamorphic rocks are known, but they are of little or no importance to the engineer, and hence are not considered. The six groups given above are treated below in the order named.

It is both possible and helpful to illustrate in a general way the metamorphic equivalent of each of the principal types of sedimentary and igneous rocks, as shown in the following tables.¹

TABLE OF SEDIMENTARY ROCKS AND THEIR METAMORPHOSED EQUIVALENTS

Loose sediments.	Compacted sedimentary rocks.	Metamorphic rocks.
Gravel Sand Silt and clay Lime deposits	Conglomerate Sandstone Shale Limestone	Gneiss and schist Quartzite Slate Marble

TABLE OF IGNEOUS ROCKS AND THEIR METAMORPHIC DERIVATIVES

Igneous rocks.	Metamorphic rocks.
Coarse-grained feldspathic rocks, } such as granite, syenite, etc. }	Gneiss
Fine-grained feldspathic rocks, such } as felsite, tuffs, etc. }	Schists, etc.
Ferruginous rocks, such as dolerites } and basalts. }	Schists, etc.

Gneiss

Definition. — Gneiss² is an old word that originated among the early Saxon miners, and has had rather loose geological usage. It was applied more particularly to laminated rocks having the mineral composition of granite, but was later extended by many to include other laminated types of plutonic igneous rocks. It has thus had a dual meaning by many, comprising both structural and mineralogical factors. In Germany the word gneiss has been employed to apply to those laminated rocks containing quartz and feldspar with one or more minerals.

The term gneiss, following Van Hise, is used in this book strictly in the structural sense. It may be defined as any banded metamorphic rock, whether originally of igneous or sedimentary origin,

¹ Pirsson, *Rocks and Rock Minerals*, p. 348.

² Quarrymen usually but erroneously apply the name granite to gneisses.

the bands of which are mineralogically unlike and consist of interlocking mineral particles which, for the most part, are large enough to be visible to the naked eye. The bands may vary in regularity (Plate XVI, Figs. 1 and 2), and in thickness may range from a fraction of a centimeter to many centimeters. Likewise a similar range in thickness of the different bands of the same gneiss may be noted.

Mineral composition.— The most important gneisses correspond in mineral composition to plutonic igneous rocks, but they are not necessarily, as defined above, of igneous origin, since many gneisses are known to be metamorphosed sediments. Feldspar, both the alkalic and soda-lime varieties; quartz, mica, either biotite or muscovite, or both; and hornblende are the commonly occurring minerals in gneiss.

Besides these, many other minerals may occur, such as garnet, epidote, sillimanite, tourmaline, chlorite, etc., and any one of these may be present in large enough quantity to give specific or varietal name to the rock.

Chemical composition.— The chemical composition of gneisses is necessarily widely variable, the variation being of the same order as that of the original rocks (igneous and sedimentary) from which they were derived. To the petrographer the chemical analysis of a gneiss is often of great value in affording a clue as to the kind of original rock from which it was derived, whether igneous or sedimentary.

The range in chemical composition of the gneisses is illustrated in the table of analyses below, arranged in order of descending silica:

ANALYSES OF GNEISSES

	I.	II.	III.	IV.	V.	VI.	VII.	VIII.
SiO ₂	77.53	70.21	69.29	66.13	61.04	48.68	46.63	38.05
Al ₂ O ₃	13.60	13.95	14.07	15.11	16.97	14.39	19.47	24.73
Fe ₂ O ₃	0.23	1.05	2.59	2.52	4.00	3.26	5.65
FeO.....	0.16	3.08	2.03	3.19	5.58	10.09	6.63	6.08
MgO.....	Trace	1.26	1.32	2.42	3.62	6.32	5.37	11.58
CaO.....	0.73	3.10	2.76	1.87	5.99	9.23	9.15	1.25
Na ₂ O.....	6.65	3.27	2.89	2.71	1.96	2.31	3.19	2.54
K ₂ O.....	1.20	2.69	2.87	2.86	0.55	0.47	1.55	1.94
H ₂ O.....	0.33	0.67	0.43	1.79	0.43	2.49	1.71	7.53
Rest.....	0.19	1.02	0.84	1.27	3.73	2.20	3.12	0.93
	100.62	100.30	99.09	99.87	98.87	100.18	100.08	100.28

I. Losee gneiss, northeast of Berkshire Valley, N. J.; II. Baltimore gneiss, near Philadelphia, Penn.; III. Biotite granite-gneiss, near Manchester, Chesterfield County, Virginia; IV. Mica (muscovite) gneiss, near Philadelphia, Penn.; V. Quartz norite-gneiss, Odessa, Minnesota; VI. Hornblende gneiss near Philadelphia, Penn.; VII. Plagioclase gneiss, north fork of Mokelumne River, Amador County, California; VIII. Gabbro-diorite gneiss, below Quinnesec Falls, Wisconsin.

Varieties.— Varietal distinctions of gneisses may be based on (1) structural differences, such as *banded gneiss*, *foliated* or *lenticular*

gneiss, *augen gneiss*, etc.; (2) character of the prevailing accessory mineral, as in granite, such as *biotite gneiss*, *muscovite gneiss*, *hornblende gneiss*, etc.; and (3) on composition and origin, such as *granite-gneiss*, *syenite-gneiss*, *diorite-gneiss*, *gabbro-gneiss*, etc.

Granulite is the name applied to a finely banded rock composed chiefly of quartz and feldspar, and sometimes the accessory minerals garnet, cyanite, etc. The name was originally applied to rocks in Germany where they were first studied, but the usage since has not been uniform, and is seldom employed at present in the United States.

General properties. — In *texture*, gneisses are compact holocrystalline rocks, and may range from even-granular to pseudo-porphyritic, in which the principal minerals though variable in size (ranging from fine through medium to coarse) are distinguishable by the naked eye. Porphyritic texture is common among the feldspathic gneisses in which feldspar is the porphyritically developed mineral.

In *structure*, gneisses are banded rocks, in which the lines may be straight or regular, or curved and contorted. The lines may be continuous or short and lenticular, and the individual bands may be extremely thin or thick. In *color*, great variation is shown, depending chiefly on the kinds and proportion of the principal minerals. Hence, variation may range from nearly white through shades of red, gray, brown, green, to nearly black.

Other physical properties, such as hardness, specific gravity, absorption, etc., are similar to their equivalent igneous types, and are dependent chiefly on mineral composition, size and shape of grain. (See Chapter on Building Stone.)

Uses. — On account of the banded structure, gneiss cannot be worked so uniformly as granite, hence its use is more restricted. On the other hand, the banded structure permits of the rock being split into more or less parallel flat surfaces, and of use in the construction of rough walls and for street work. When used for constructional purposes the rock should be placed like sedimentary ones, so that the foliation lies in the mortar bed and not on edge, in order to avoid splitting and scaling. (See further under Chapter on Building Stone.)

Occurrence and distribution. — Gneiss is one of the most common and widely distributed of rocks. It is especially abundant in the older geological formations, more particularly in the pre-Cambrian horizons, but may occur in formations as late as Mesozoic. It forms extensive areas in Canada, the Appalachians, Cordilleran, and upper Great Lakes regions in the United States; and has similar wide distribution over other parts of the world.

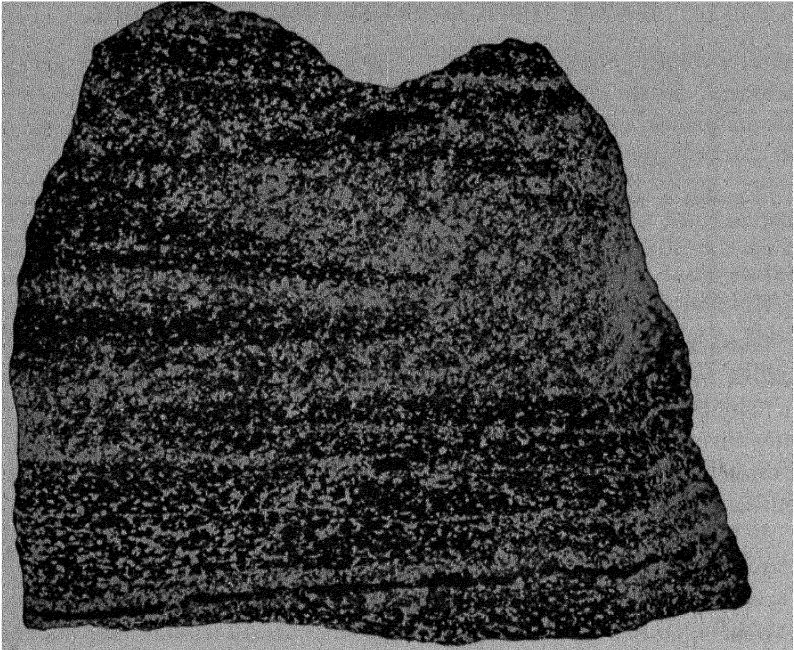

PLATE XVI, FIG. 1. — Hornblende gneiss, showing irregular banding. Dark patches, hornblende; light areas, mixed quartz and feldspar. (From Ries, Building Stones and Clay Products.)

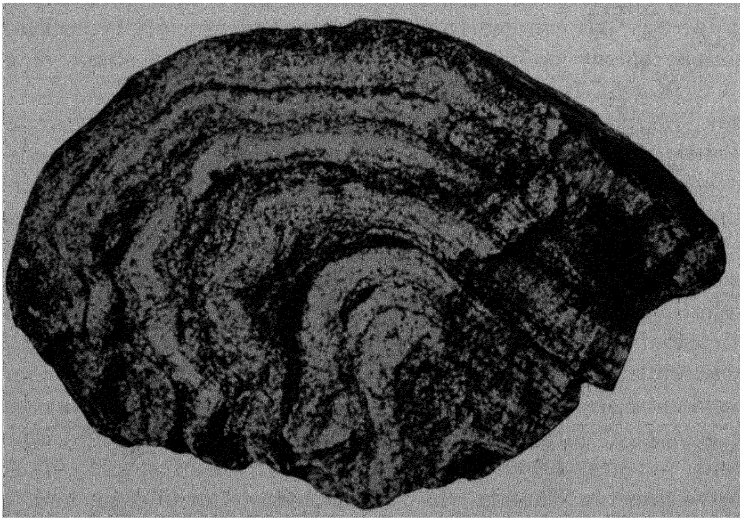

FIG. 2. — Biotite gneiss, showing folding of the bands.

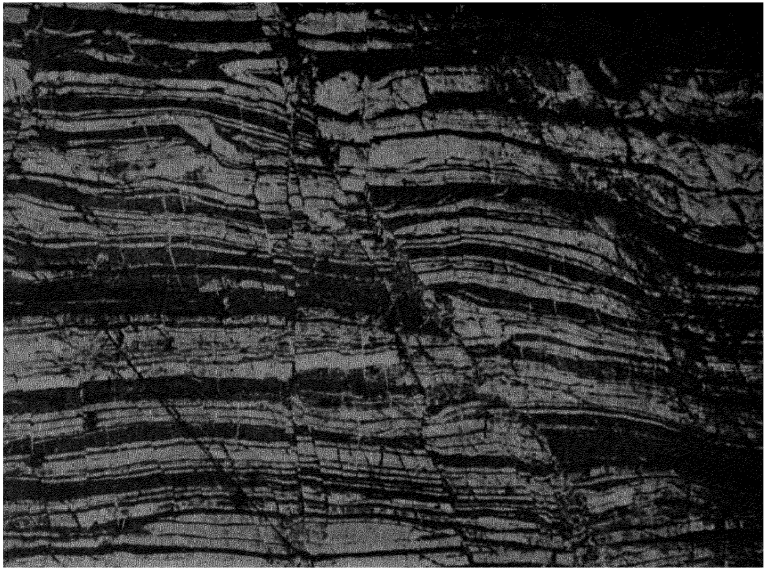

PLATE XVII, FIG. 1. — Magnetite gneiss, showing distinct banding. The bands are also broken by small faults, Temagami, Ont. (H. Ries, photo.)



FIG. 2. — Gneiss quarry, near Lynchburg, Va. Shows regular banding of the gneiss. (T. L. Watson, photo.)

Crystalline Schists

Definition. — The term *schist*, like *gneiss*, has loose geological usage and by many has been employed in a dual sense, — structure and mineral composition. Following Van Hise in the definition of *gneiss*, *schist*, as used in this book, is defined to include those foliated metamorphic rocks, whose individual folia are mineralogically alike, and whose principal minerals are so large as to be visible to the naked eye. This definition is uniform with that of *gneiss* and *slate*, into either of which a *schist* may grade. Because of this fact, it frequently happens that no hard and fast line can be drawn between *schists* and *gneisses*, and by becoming finer in grain and texture, the *schists* may grade into *slates*. By decrease in mica and increase in quartz, mica *schists* may pass into quartz *schists* and *quartzites*.

Mineral composition. — Mineralogically the crystalline *schists* include a large and extremely variable group of rocks. They differ from the *gneisses* in mineral composition chiefly in the lack of *feldspar* as an essential mineral, although they may be and are sometimes *feldspar-bearing*. *Quartz* is the most frequent and abundantly occurring essential constituent, with, in the more common varieties of the rocks, one or more minerals of the mica, *chlorite*, *talc*, *amphibole*, or *pyroxene* group.

The *schists* are especially rich in accessory minerals, among the common ones being *feldspar*, *garnet*, *cyanite*, *andalusite*, *sillimanite*, *staurolite*, *ottrelite*, *epidote*, *tourmaline*, *magnetite*, *pyrite*, etc. Any one of these may be present to the extent of giving varietal name to the rock. Many other minerals occur in *schists* and at times are locally important, but they are of less general importance than the ones mentioned above.

Chemical composition. — Considered as a group, the crystalline *schists* vary indefinitely in chemical composition, and even for the same variety, such as the common one, mica *schist*, wide variations are shown. Practically all gradations may be found ranging from the most acid (*quartz schists*) to the most basic (*amphibolite schists*).

The wide range in composition is shown in the table below, in which are assembled analyses of some of the different varieties of *schist*, arranged in order of descending silica.

Varieties. — The varietal names given to the more important kinds of *schists* are based chiefly upon the character of the prevailing ferromagnesian mineral present. Thus we have *mica schists*, *chlorite schists*, *hornblende* and *actinolite schists*, *talc schists*, etc. Of

ANALYSES OF CRYSTALLINE SCHISTS

	I.	II.	III.	IV.	V.	VI.	VII.	VIII.	IX.
SiO ₂	91.65	90 91	75 54	70 40	64 77	64.28	57 24	34.92	12.35
Al ₂ O ₃	1 59	4 18	18 65	14 70	14 45	17 28	23 48	32 31	0.10
Fe ₂ O ₃	3 57	0 22	0 35	0 65	1 84	1 10	3 19	10 21	58.68
FeO	0 21	1.27	0 06	2 57	4 54	5 34	4 87	8 46	21.34
MgO	0 17	0 37	None	1 47	2 34	2 57	0 93	1 13	4.08
CaO	None	0 22	0 03	1 63	2 33	1 19	0 09	0 36	1 91
Na ₂ O	0 07	0 77	None	3 17	1 37	0 91	1 18	2 12	Trace
K ₂ O	1 93	0 58	None	3 46	5 03	2 93	3 55	1 87	None
H ₂ O	0 60	0 80	4 77	1 10	1 99	2 92	4 98	5 29	0.19
Rest.	0 13	0 74	0 64	0 88	1 92	0 54	0 27	3 60	1 59
	99 92	100 06	100.01	100 03	100 58	100 01	99 68	100.27	100.24

I. Quartz schist, near Stevenson station, Maryland; II. Quartz-sericite schist, Mount Ascotney, Vermont; III. Sillimanite schist, San Diego County, California; IV. Feldspathic mica schist, Mariposa County, California; V. Mica schist, near Gunflint Lake, Minnesota; VI. Andalusite schist, Mariposa County, California; VII. Sericite schist, Ladiesburg, Maryland; VIII. Chloritoid phyllite, Liberty, Maryland; IX. Actinolite-magnetite schist, Mesabi Range, Minnesota. All analyses are quoted from "The Data of Geochemistry" by Clarke, Bull. 491, U. S. Geol. Survey, 1911.

these, the mica schists are the most common and widely distributed. The mica may be biotite or muscovite, or both.

Frequently the hydrous mica, sericite, prevails, giving *sericite schist*; less often the soda mica, paragonite, is present producing a more restricted type known as *paragonite schist*. The mineral ottrelite occurs in the rocks of some localities, which gives rise to the variety *ottrelite schist*.

Among the principal accessory minerals that may be sufficiently developed at times as to give rise to modified varietal names are garnet, staurolite, sillimanite, andalusite, cyanite, magnetite, tourmaline, etc.

Greenstone schists, sometimes called "green schists," has been applied to schists of green color rather than to those of definite mineral composition, and both hornblende schists and chlorite schists have been included under it.

General properties. — All schists are alike *structurally* in having more or less pronounced schistosity or foliation as a common feature. Hence, they split readily in the direction of foliation, sometimes with smooth and even surfaces, but they break with more or less difficulty, and often with irregular surfaces, at right angle directions to the schistosity.

On account of the slippery character of the foliation planes, they will sometimes if unsupported cause rock slips in quarries, railway cuts, and underground workings.

In many schists, especially in some of the common mica varieties, quartz is distributed through the rock in the form of eyes or small lenses about which the mica folia are wrapped, so that when parted

along the direction of foliation an uneven or lumpy surface is shown. Because of their foliated structure schists are not desirable rocks for use as building stone.

Schists resemble each other *texturally* in being holocrystalline rocks, whose principal minerals are sufficiently large to be visible megascopically, and are graded according to the size of individual mineral grains into fine-, medium-, and coarse-grained rocks.

In *color*, schists exhibit a very wide range, dependent chiefly upon the kind and proportions of their principal minerals. Mica schists usually vary from very light, through gray and brown, to very dark, depending on the proportion of light- and dark-colored micas present. Chlorite schists are usually some shade of green; common hornblende schists vary from green to black; and talc schists are usually light, white to pale green, yellowish, or gray; sometimes dark gray.

Other physical properties, such as hardness, specific gravity, etc., also show much variation, dependent mainly on mineral composition, and the proportions of the principal constituents.

Uses.— The structural peculiarities of schists described above make them undesirable for use as building stone. When sufficiently solid, they are extensively employed, however, for purposes of rough construction, such as foundations, bridges, flagging, etc.

Occurrence and distribution.— The crystalline schists being metamorphic rocks, derived either from original sedimentary or igneous masses, have great areal distribution and are the common types in regionally metamorphosed areas. Mica schists form the country rock over much of the eastern crystalline belt including New England and extending southwestward to middle northern Alabama. They also occur, though to a less extent, around Lake Superior and in the West. Hornblende schists are very common rocks in metamorphic regions, where they form belts, less often independent large areas, in the midst of other metamorphic rocks, especially gneisses and mica schists. Many of their occurrences in the form of long bands and belts, and as large areas about igneous masses, suggest derivation from igneous rocks; although they are known to have been formed in places from impure sedimentary beds by metamorphism.

Chlorite schists and talc schists are common types in New England, the crystalline region of the Appalachians, and around Lake Superior. The chlorite schists have been derived chiefly from rocks containing abundant ferromagnesian silicate minerals, while the talc schists have been formed from the metamorphism of rocks rich in magnesian silicates that were poor or lacking in iron.

Quartzite

Definition. — Quartzites in general are the metamorphosed equivalents of sandstones, into which they may grade with frequently no sharp line of demarcation noted between them. They are hard and compact crystalline rocks which break with a splintery or conchoidal fracture.

Quartzites differ from sandstones mainly in their greater hardness, denseness, and crystalline character, properties which result from metamorphism. A practical distinction that may often be made between the two rocks is that, when sandstones are fractured, the fracture passes between the individual sand grains and not across them, whereas in quartzites the fracture passes through rather than between the component grains.

Mineral and chemical composition. — Some quartzites are remarkably pure, composed almost entirely of quartz, with such other minerals as may occur present only in microscopic size and proportion. The chemical analysis of such a rock will yield nearly all silica, with scarcely more than traces of other oxides. Many quartzites, however, contain other minerals besides quartz, some of which have resulted from the metamorphism of the clay, lime, and iron oxide cement which bound the sand grains together in the original rock.

Besides quartz, there may be present in variable amounts, feldspar, mica (muscovite or biotite), chlorite, cyanite, epidote, magnetite, hematite, graphite, and sometimes calcite. One or more of these minerals sometimes occur in such amounts as to exercise some control over the properties of the rock. The chemical composition, therefore, of the quartzites will vary in accordance with that of mineral composition.

Varieties. — The distinction between quartzites may be made on the basis of the presence of certain accessory minerals, such as *chloritic quartzite*, *micaceous quartzite*, *feldspathic quartzite*, *epidotic quartzite*, etc. Other varieties, based on differences in texture and structure are known. *Buhrstone* is a cellular but hard and tough quartzite representing, in some cases at least, a silicified limestone, and formerly used as a millstone. *Itacolumite*, known also as flexible sandstone, is the name given to a more or less micaceous variety, whose grains are loosely interlocked and have the power of slight movement on one another. *Quartzite-schist* is a variety in which foliated structure has been developed, the surface of the foliation

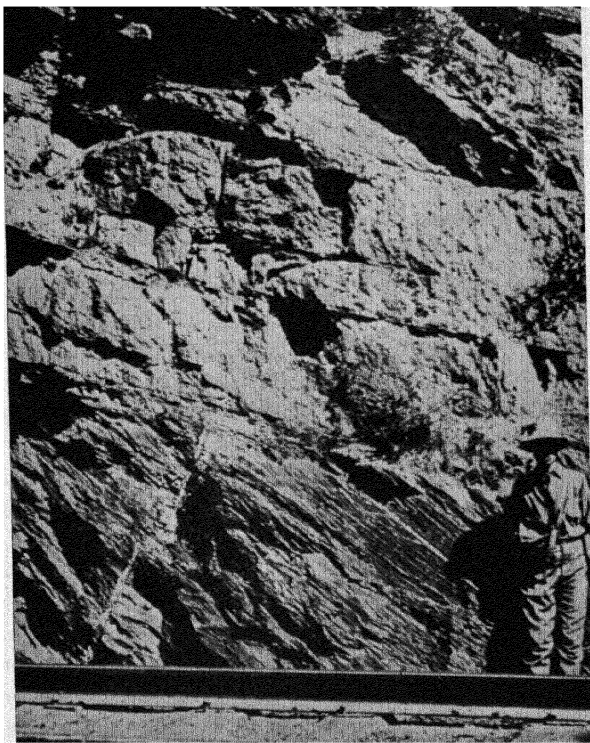

PLATE XVIII.—Beds of slate, showing cleavage, overlain by quartzite. The bedding of the slate which does not show in the view is parallel with that of the quartzite. Field, B. C. (H. Ries, photo.)

planes being coated with scales of mica. Quartzites which have formed from pebbly sandstones or conglomerates are known as *conglomerate quartzites*. The pebbles in some of these have been stretched and flattened from dynamic metamorphism.

General properties.— *Texturally*, quartzites are hard and tough, usually firm and compact, granular rocks, whose individual grains may range from fine to coarse in size. Quartzites may form thin or thick massive beds in the midst of other metamorphic rocks (Plate XVIII), especially schists. They may be white, gray, yellowish, greenish, or reddish in *color*. The dense and compact varieties have low porosity and absorption, and high compressive strength. These properties together with that of high siliceous composition render quartzite a resistant and durable rock. They are usually hard to drill and also to dress.

Uses.— On account of their great durability and resistance to atmospheric agents and high temperatures, quartzites, whose joint planes are sufficiently spaced to permit the extraction of dimension stone, may be used to advantage as a building stone. Hardness is their principal drawback, both in quarrying and dressing the stone. In the form of crushed stone, quartzites are admirably suited for railroad ballast, concrete work, etc. The purer varieties are sometimes ground for glass sand.

Occurrence and distribution.— Quartzites occur in association with schists and other metamorphic rocks in masses up to hundreds of feet in thickness. They are widely distributed rocks, occurring in nearly all areas of metamorphosed sediments, but have their greatest development in the older geological formations, especially in the Cambrian and pre-Cambrian. Quartzites are common in the eastern metamorphic region, including New England and the Appalachians, around Lake Superior, and in many places in the West.

Slate and Phyllite

Definition.— Slate may be defined as a thinly cleavable rock, the cleavage pieces of which are mineralogically alike, and the mineral grains so small in size as not to be distinguishable by the eye. It is a dense or aphanitic, homogeneous rock of very fine texture. As pointed out below the cleavage (Fig. 68) of slate is a secondary structure produced by metamorphism and not an original one in the sense of bedding, stratification, or lamination, as in shales and similar sediments; hence, the distinction between slate and shale.

Slates are the metamorphic equivalents of muds and shales and

less often of volcanic ash and tuffs; hence, they represent the finest particles of mineral matter. Shales, slates, phyllites, and mica schists form a continuous series of rocks derived chiefly from clay or mud by progressive metamorphism (dehydration and crystallization). Gradations exist between shales and slates on the one hand, and between slates, phyllites, and mica schists on the other.

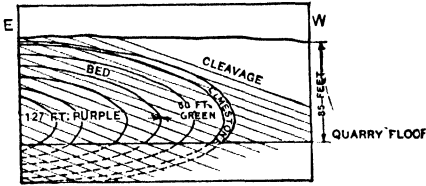

FIG. 68.— Section showing relation of cleavage to stratification. (After Dale.)

Mineral and chemical composition.

— Megascopically, the mineral composition of slates is of no importance, since the constituent grains of the rock are too small in size to be distinguished by the eye. When examined in thin section under the microscope, however, slates reveal a variety of minerals, the principal ones of which are quartz and mica (biotite and muscovite, including sericite).

Besides these occur chlorite, feldspar, magnetite, hematite, pyrite, carbonates of lime, iron, and magnesia, carbonaceous matter and graphite, zircon, tourmaline, rutile needles, andalusite, ottrelite, staurolite, anatase, etc.

Slates are normally clayey or argillaceous rocks in composition, but are subject to considerable variation chemically. The range in essential chemical composition of commercial slate of aqueous sedimentary origin, as shown by Dale in 29 analyses, is as follows:

RANGE OF COMPOSITION OF SLATE		Per Cent
Silica	55-67
Alumina	11-23
Ferric oxide	0.52- 7
Ferrous oxide	0.46- 9
Potash	1.76-5.27
Soda	0.50-3.97
Magnesia	0.88-4.57
Lime	0.33-5.20
Water above 110° C.	2.82-4.09

Chemical analyses of commercial slates have economic importance in their bearing on the question of the cause of fading observed in some slates.

Varieties. — A convenient grouping of commercial slates based on origin and composition, as developed by Dale, is into (A) aqueous sedimentary, subdivided into (1) clay slates and (2) mica slates, including (a) fading and (b) unfading; and (B) igneous, subdivided into (1) ash slates and (2) dike slates.

General properties. — Slates are *texturally* dense and compact very fine-grained rocks, whose component minerals are not distinguishable

megascopically. Their most important structural feature is *cleavage*, by virtue of which the rock readily splits into thin sheets or slabs, and the regularity and perfection of which renders the slate of value for roofing purposes. Slaty cleavage as discussed on page 199 is a secondary structure, developed by metamorphism, which may or may not coincide with the original bedding; usually it does not, but may cut it at almost any angle. The original bedding planes of the rock usually become closed during the process of metamorphism and when visible in the slate they appear as lines or bands known as *ribbons*, which may be of different color or of different mineral composition (siliceous and calcareous material being the most common), and which are often plicated. When irregular and numerous, ribbons may render the slate worthless. Fracture cleavage, known as false or slip cleavage, superinduced on the slaty (flow) cleavage of some slates, when well developed, may render the slate of doubtful commercial value for some uses. (See Fig. 200.)

The cleavage surfaces may be quite lustrous, but are usually dull. They may be very smooth or may show extremely fine plications. Sometimes the cleavage surfaces are spotted, and in some slates are even knotty from the presence of certain minerals.

The cleavage of the slate is often responsible for the rock slips which occur in many excavations made in this kind of rock.

The usual *color* of slate ranges from gray to dark or bluish-black but red, green, and purple shades are also known. The gray and black slates owe their color to the presence of variable amounts of carbonaceous matter; the red and purple ones to iron oxide; and the green ones sometimes to the presence of chlorite.

The average specific gravity of slate is about 2.75, but may be affected by the presence of such minerals as magnetite, pyrite, etc. Slates are rather soft rocks and may be readily cut, a property which is of considerable economic importance. For other properties and uses of slate, see Chapter on Building Stone.

Occurrence and distribution. — Slates are common rocks in metamorphic areas and have a wide range geologically. Those of the eastern United States are chiefly of Cambrian and Ordovician age. Slates have rather extensive distribution in the Lake Superior region, and in many places in the West, especially along the western slopes of the Sierra Nevada Mountains.

The principal production of slate in the United States is from the eastern states (see Chapter on Building Stone).

Phyllite

Phyllite is the name given to a group of thinly cleavable, finely crystalline, micaceous rocks intermediate between the mica schists and slates, into which they may grade. They probably represent a more advanced stage of metamorphism than slates. Quartz and usually sericite are the principal minerals, but others, such as garnet, pyrite, etc., are frequently present in small amounts. Probably the so-called *hydromica schists*, described by the older geologists in this country, are for the most part phyllite.

Phyllite differs from slate in containing a larger amount of mica which is visible to the naked eye, and the rock is more brittle but not so tough. It is usually light in color, sometimes nearly pure white, but frequently of various darker shades, even black in some cases. It is apt to be soft and has a rather greasy feel.

Crystalline Limestones and Dolomites (Marbles)

Introduction. — Under this head are included all rocks composed essentially of calcium carbonate (limestone) or a mixture of calcium and magnesium carbonates (magnesian limestone and dolomite) that have a crystalline or granular texture. They have been formed from ordinary limestones and dolomites described on pages 118 to 121 by the processes of metamorphism, either of contact or regional character (pages 214, 216). Such crystalline limestones and dolomites are the metamorphic equivalents of the ordinary carbonate rocks, and are known geologically as marbles; but in the trade the term marble is applied to any limestone that will take a polish, whether crystalline or not. The serpentinous marbles are separately discussed under “*ophicalcites*” as a member of the next group of metamorphic rocks (pages 145).

Composition. — Since the crystalline limestones and dolomites are the metamorphic equivalents of the ordinary carbonate rocks, they naturally show the same range in chemical composition. Most limestones contain impurities, such as silica, carbonaceous matter, iron oxides, argillaceous or clayey material, etc., so that when subjected to metamorphism, the change involves not only crystallization but the development of new minerals; hence the crystalline limestones and dolomites may show great diversity in mineral composition, ranging from essentially pure crystalline carbonate rocks on the one hand to an aggregate of nearly all silicates on the other.

From carbonaceous material will develop graphite which causes

dark spotting or streaking, or in some cases a uniformly dark color. Other impurities of the character mentioned above will develop, under conditions of metamorphism, various silicate minerals.

These include phlogopite and biotite among the *micas*, wollastonite and diopside among the *pyroxenes*, tremolite and actinolite among the *amphiboles*, grossularite among the *garnets*, and many others. In addition to these quartz, magnetite, spinel, titanite, and pyrite, etc., sometimes occur. Clarke states that "the list of minerals now known as existing in metamorphosed limestones must comprise at least 70 species, and possibly more."

General properties. — Marbles, when pure, are compact crystalline granular rocks composed of calcite or dolomite, or a mixture of the two. The texture may range from exceedingly fine-grained, in which the individual grains are so small in size as not to be distinguishable, to very coarse-grained, in which the grains may attain a size of a quarter of an inch and more in diameter. All gradations between these two extremes occur. The texture affects the weathering qualities, ornamental value, and to some extent the working qualities of the stone.

Unlike many metamorphic rocks, marble, when pure, is apt to be massive and without indication of schistose structure, but when impure from the presence of other minerals (such as mica) these may be so arranged as to produce schistosity. This is especially true of the impure marbles of the Piedmont region in the Atlantic states, where they are frequently found grading into true calcareous (calcite) schists. Marbles which are strongly banded by mica are not as durable in a severe climate, nor do they take a continuous polish. Some marbles show a brecciated structure (Plate IX, Fig. 1), and these though often of highly ornamental character are not adapted to exterior work.

Marbles show a wide range of color, dependent chiefly upon their purity. The pure ones are white, others gray to black, and still others may show varying shades of red, pink, yellow, green, brown, etc. The principal impurities which act as a pigment influencing color are carbonaceous matter and the oxides of iron, as well as finely-divided mica. The color may be entirely uniform in the pure marbles, but more often it is spotted, blotched, or streaked. Absorption is low, usually less than one per cent, but even fine-grained apparently dense marbles may be relatively permeable.* The specific gravity

* This may be tested by soaking the dry stone for 24 hours in a 4 per cent alcoholic solution of nigrosine, then splitting the marble, and noting how deep the dye has penetrated.

generally averages between 2.66 and 2.79. The hardness of the calcite marbles is 3, and for the dolomitic ones 3.5 to 4, but all are readily scratched by the knife. The calcite marbles may be distinguished from the dolomitic ones by effervescing in cold dilute acid (see pages 35 and 36).

Alteration. — Marbles like ordinary limestones are soluble rocks and weather with comparative readiness, the calcareous material being dissolved and removed in solution with such insoluble impurities as may have been present in the rock left in place to form the mantle of residual decayed material. In some quarries solution fissures penetrate the stone to some depth, causing waste in quarrying. They may also serve as entrance channels for surface waters to reach mine workings or tunnels. Sometimes the coarser textured marbles, especially those of dolomitic composition, weather through physical causes, breaking down into a coarse sand or gravel as in the Adirondacks and western New England.

Occurrence and distribution. — Since the crystalline limestones (marbles) are the result of metamorphism they are necessarily found in metamorphic regions in association with gneisses, schists, slates, etc. They form interstratified masses or lenses with schists, slates, etc., which vary greatly in size. On account of the variation in texture and purity of the different beds in a given section, all may not be of equal commercial value. They have extensive development and economic importance throughout the metamorphic crystalline region of the eastern United States, where quarries have been opened in most of the states, with Vermont, Tennessee, Georgia, Missouri, Alabama, New York, and Massachusetts, in the order named, as the principal producers. Marbles are found in places in the West, being strongly developed in Colorado, California, and Washington. They have extensive development in Eastern Canada, and in similar metamorphic regions of other countries.

The *uses and properties* of marble for structural purposes are discussed in the Chapter on Building Stone. Marbles can be employed for all purposes to which limestones are put.

Ophicalcite, Serpentine, and Soapstone

In general characters and origin this group of rocks has many points of resemblance, and for convenience may therefore be treated together. It is a series whose members range in mineral composition from a mixture of silicate and carbonate minerals as in ophicalcite to essentially all silicate components as in the pure serpentine and soap-

stone. Through the first member of the series, opicalcite, the group as regards composition (containing in part carbonates) and texture may be considered as related to the preceding one, marbles including crystalline limestones and dolomite. In composition the soapstones are rocks related closely to the talc schists into which they may grade through the development of foliated structure by dynamic metamorphism.

The following table of analyses serves in a general way to indicate the chemical relationships as well as points of difference between the members of this group of rocks.

ANALYSES OF SERPENTINE AND SOAPSTONE

	I.	II.	III.	IV.	V.	VI.	VII.	VIII.
SiO ₂	44.14	43.87	42.52	40.42	39.14	62.00	58.40	38.85
Al ₂ O ₃		0.31		1.86	2.08			12.77
Fe ₂ O ₃			1.96	2.75	4.27		7.44	12.86
FeO.....		7.17		4.27	2.04			
MgO.....	42.97	38.62	42.16	35.95	39.84	33.10	29.19	22.58
CaO.....		0.02		0.66	Trace			6.12
Na ₂ O }				0.16				0.30
K ₂ O }								
H ₂ O.....	12.89	9.55	14.22	10.72	12.70	4.90	4.97	6.52
Rest.....		0.27		2.68	0.11			
	100.00	99.81	100.86	99.47	100.18	100.00	100.00	100.00

I. Theoretical composition of pure serpentine; II. Serpentine, Webster, North Carolina; III. Serpentine, Montville, New Jersey; IV. Dark green serpentine, Rowe, Massachusetts; V. Serpentine, Greenville, California; VI. Theoretical composition of pure talc; VII. Soapstone, Fairfax County, Virginia; VIII. Soapstone, Albemarle County, Virginia.

Opicalcite

Opicalcite, known also as *ophiolite*, is the name given to marbles (crystalline limestones) streaked and spotted with serpentine. The name is usually restricted to a mixture of green serpentine and white calcite, magnesite, or dolomite in variable proportions. The serpentine occurs as irregular large and small stringers and masses, and may contain a core of the original silicate mineral from which it was derived. *Verde antique* is a general name applied to green serpentinous marble.

It seems probable that the opicalcites were derived from originally impure limestones by metamorphism, which rendered the rock entirely crystalline and the impurities crystallized out in the form of silicate minerals, such as pyroxene, hornblende, olivine, etc. The silicate minerals were later secondarily converted by hydration into serpentine. It has been shown by Merrill that the serpentine in dolomite of Montville, New Jersey, and that of the opicalcites of Warren County, New York, was derived from pyroxene.

Ophicalcites are not very abundant rocks but are highly prized for use as a decorative stone. They are soft rocks and can be easily polished, but as a rule they weather readily and unequally on exposure. Another defect in the rock is the presence of numerous joints and fractures so closely spaced that stone of more than a few feet in size can rarely be obtained.

Ophicalcite occurs in Quebec, Canada, in the northern Green Mountains, and in the Adirondacks of New York State.

Serpentine

General properties. — Pure serpentine is a hydrous silicate of magnesia, but as masses forming the rock serpentine it is usually more or less impure from the varying quantities of other minerals mixed with it. These may include among the silicates olivine, pyroxene, and hornblende; the oxides magnetite and chromite; the sulphide pyrite; and the carbonates of lime and magnesia, through the increase of which serpentine proper grades into the serpentinous marbles or ophicalcites. Garnet of the variety pyrope and biotite or a magnesian mica sometimes occur. Other secondary minerals may and sometimes do accompany serpentine.

Some of the associated minerals such as olivine, pyroxene, and hornblende are the remains of the original magnesian silicates from which the serpentine was derived. Others, like serpentine itself, are secondary, having separated out and formed during the process of alteration. Because of the variety and varying quantities of associated minerals serpentine may show great diversity in chemical composition, as represented in the table of analyses on page 145.

When reasonably pure, the rock serpentine is compact, though a variety of texture may be shown. It is dull to waxy in luster, breaks usually with a smooth to splintery fracture, and is soft enough to be cut by the knife, but from the presence of silica it may be much harder. The usual color is green to yellowish green, sometimes yellow, with the more impure forms exhibiting various shades of brown, red, and black.

Origin and occurrence. — The serpentine rocks are secondary, having been formed from pre-existing ones through processes of alteration. They may be formed through alteration of any basic rock composed essentially of magnesian silicates, especially olivine, pyroxene, or amphibole. As such most of the serpentines have probably been formed by the alteration of basic igneous rocks, such as peridotites, pyroxenites, etc. Hornblende schists may also yield them.

Serpentine is a common and widely distributed rock in metamorphic regions, occurring as an alteration from both igneous and metamorphic rocks. It seldom forms large and extensive masses, but occurs in places in the metamorphic crystalline region of the eastern United States extending from New England to Georgia; in several of the western states, especially California, Oregon, and Washington; and in eastern Canada. Many serpentine deposits show an abundance of slipping planes, which cause trouble by rock slides or slips in quarries, railroad cuts, and other excavations. Indeed engineers in laying out a railroad may try to avoid this kind of rock if they are familiar with its characteristics.

Uses. — Serpentine is used chiefly as an ornamental stone, but as a rule is of such low weathering resistance as to often make it unsatisfactory for exterior use. (See Chapter on Building Stone.)

Soapstone

General properties. — Soapstone, called also steatite, is composed essentially of the mineral talc as shown in the table of analyses on page 145. It is closely related to the talc schists into which it grades on the development of foliated structure by dynamic metamorphism. Like serpentine, it is a hydrous silicate of magnesia, but contains more silica and less water. These differences are indicated in the table of analyses below of the theoretic percentages of constituents in the chemically pure minerals.

	SiO ₂	MgO	H ₂ O
Serpentine	44 14	42.97	12 89
Talc (soapstone)	62 00	53 10	4 90

Soapstone is never chemically pure, but contains varying quantities of the minerals, mica, chlorite, amphibole (tremolite), pyroxene (enstatite), together with quartz, magnetite, pyrrhotite, and pyrite. Carbonates may be present in some cases.

Soapstone is a massive rock of bluish-gray to green color, sometimes dark, and is soft enough to be readily cut with the knife, hence it can be easily worked. It has a pronounced soapy or greasy feel, and resists to a marked degree heat and the action of acids, properties which make the stone of especial value for use in the trades, and for which it is extensively quarried.

Origin and occurrence. — Soapstone is a secondary rock derived from the alteration of magnesian silicate minerals, such as tremolite, enstatite, etc., in the same general way as serpentine (page 146). It is found therefore in metamorphic regions in association with talcose and chloritic rocks, sometimes with serpentine and beds of crystalline limestones. It is a common rock in many localities in the metamorphic region of the eastern United States. It has wide distribution in the metamorphic crystalline area of Virginia, which is the principal producing state in the United States, the common rock associates being schists of varying composition.

Uses. — Soapstone is a very durable rock, but on account of its somber color, soapy feel and softness, it is undesirable for general constructional purposes. Because of its ready workability due to softness, insolubility and heat-resisting qualities, it is suited to a considerable range of applications. Most of the product quarried at the present time is used in the manufacture of wash or laundry tubs, electric switchboards and insulators, and laboratory sinks. Some of the harder material quarried in Virginia makes excellent stair treads, being preferred by some to slate. It was formerly used to some extent in the manufacture of stoves for heating purposes, and for fire brick, but in recent years its use for these purposes has not been so great. The waste from quarrying, and in some cases the entire output from a single quarry, is pulverized and used as a lubricant.

References on Rocks

1. Clarke, F. W., *The Data of Geochemistry*, U. S. Geol. Surv., Bull. 770, 1924, 5th edition.
2. Cole, G. A. J., *Rocks and their Origins*, Cambridge, England, 1922.
3. Daly, R. A., *Igneous Rocks and their Origin*, New York, 1914. (McGraw-Hill Book Co.)
4. Finlay, G. I., *Introduction to the Study of Igneous Rocks*, New York, 1913. (McGraw-Hill Book Co.)
5. Harker, A., *The Natural History of Igneous Rocks*, New York, 1909. (The MacMillan Co.)
6. Hatch, F. H., and Rastall, R. H., *The Petrology of the Sedimentary Rocks*, London, 1913. (George Allen & Co., Ltd.)
7. Iddings, J. P., *Igneous Rocks: Composition, Texture, and Classification, Description and Occurrence*, New York, 1909, Vol. 1; 1913, Vol. II. (Wiley & Sons.)
8. Kemp, J. F., *A Handbook of Rocks for Use without the Microscope*, New York, 1908, 4th edition. (D. Van Nostrand Co.)
9. Merrill, G. P., *Stones for Building and Decoration*, New York, 1903, 3d edition. (Wiley & Sons.)
10. Milner, H. B., *An Introduction to Sedimentary Petrography*, London, 1922. Supplement, 1926. (Thomas Murby & Co.)
11. Pirsson, L. V., *Rocks and Rock Minerals: A Manual of the Elements of Petrology, without the Use of the Microscope*, New York, 1926, 2nd edition revised by Knopf. (Wiley & Sons.)

For books dealing with the economic uses of rocks, see references in Chapters XI–XIV and XVI.

CHAPTER III

STRUCTURAL FEATURES AND METAMORPHISM OF ROCKS

Introductory

It is a matter of common observation that the rocks over many parts of the earth have been considerably disturbed since the time of their formation. Beds of sedimentary rocks, originally laid down in horizontal position in most cases, are now frequently found tilted at all angles with the plane of the horizon. In some cases the disturbance has simply involved a change in position of extensive rock masses, without seriously affecting their structure, as when the sea bottom with its sediments was uplifted without warping; but in other cases the rocks, as a result of stresses to which they have been subjected, incident to movements of the earth's crust, have been more or less seriously disturbed, and their structure more or less changed. We thus find that rocks have been folded to a variable degree, and usually traversed by fractures, along which displacement may have taken place.

The chief structures produced then as a result of such disturbances are *folds*, *joints*, *faults*, and *cleavage*.

Folds

Introduction. — Beds of sedimentary rocks are usually laid down in horizontal position, but departure from this attitude is sometimes noted, especially where deposition has taken place on steeply sloping shores and in deltas. Examination of the beds over wide regions of the earth's surface reveals the fact that they in some cases no longer preserve a horizontal attitude, but show all degrees of inclination to the plane of the horizon, because of the folding they have undergone. This is notably the case in mountain regions (Pl. XX Fig. 2). The modification of the original attitude of the beds, referred to as *deformation of strata*, has resulted from earth movements, and is recorded from field study in terms of dip and strike. (See below.)

Outcrop. — Over wide regions of the earth's surface the solid rock, known as *bed rock*, is covered with a mantle of loose rock, often the

product of atmospheric agents, as explained in Chapter IV. Within such regions the bed rock projects in places through the overlying mantle of unconsolidated rock, or on steep erosion slopes along streams, and on high steep slopes of mountains. Exposures of bed rock at the surface are known as *outcrops*, and by their careful field study, including dip and strike, the geologic structure of the region is determined. The most likely places to search for exposures of bed rock are on steep slopes and hilltops, in stream beds and roads, in cliffs along the shore, and in artificial excavations, including railroad cuts. In the examination of outcrops one must be sure that the bed rock is in place and does not represent a detached mass which has been removed from its original position and which may be partly buried in the mantle rock. Precaution is especially necessary in glaciated regions where large, partly buried boulders might readily be mistaken for bed rock in place.

Dip. — By *dip* is meant the inclination of the beds to a horizontal plane (Fig. 69). It is measured in degrees by an instrument known as a *clinometer*, which consists of a pendulum with a graduated arc. For convenience the clinometer is usually combined with the compass, so that from the former the amount of dip may be ascertained, and from the latter the direction. In measuring dip, the direction as well as the amount of inclination is taken. Thus, 24° S. 30° E. expresses the exact position of the particular bed. The maximum angle of inclination of the bed is always taken as the dip.

Strike. — This is the direction of the line of intersection of the dipping bed with a horizontal plane, and is necessarily measured at right angles to the dip (Fig. 69). Like dip, the direction of strike is read with the compass from the north point; thus, N. 60° W. If the direction of the dip remains constant, the strike is a straight line, but with change in direction of dip there also follows change of strike. Since, therefore, the direction of strike is

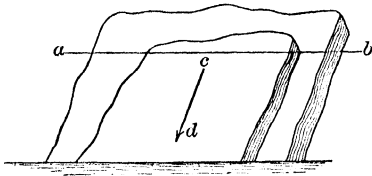

FIG. 69. — Diagram showing dip (*cd*) and strike (*ab*).

always at right angles to that of dip, if the latter is measured it is unnecessary to record that of strike. Thus, a bed with an east dip has a north and south strike. Beds having the same strike might show different angles of dip.

By accurate measurement and correlation of dip and strike observations on outcrops in regions that have suffered considerable erosion, folds may usually be determined.

Parts of folds. — The line of prolongation of a fold is its *axis*, which may be miles long or only a small fraction of a mile, but whether long or short, the dip decreases and the fold finally dies away. This crest or trough line is usually not horizontal, but inclined at varying angles with the plane of the horizon, the angle of inclination being defined as the *pitch* of the fold. The plane which bisects the angle between the limbs of a fold is known as the *axial plane* (Fig. 70), and may be curved from complex movements. The axial plane divides the fold into two parts known as *limbs*.

Kinds of folds. — All folds may be regarded as modifications of three principal types, namely, *anticlines*, *synclines*, and *monoclines*. Folds may be *simple*, *composite*, or *complex*, but as they occur in nature most of them are complex, since they are usually cross-folded, by which is meant their axial lines are folded. A single fold without crenulations may sometimes occur when it is described as a *simple* fold. If crenulations (smaller anticlines and synclines) are superposed on a simple fold it is said to be *composite*.

Anticlines. — These are folds produced by the arching of beds, so that the limbs dip away from the crest on the two sides of the axial plane (Fig. 70). The arch may be broad or gentle, or sharp and angular with steep dips, all gradations between the two being observed.

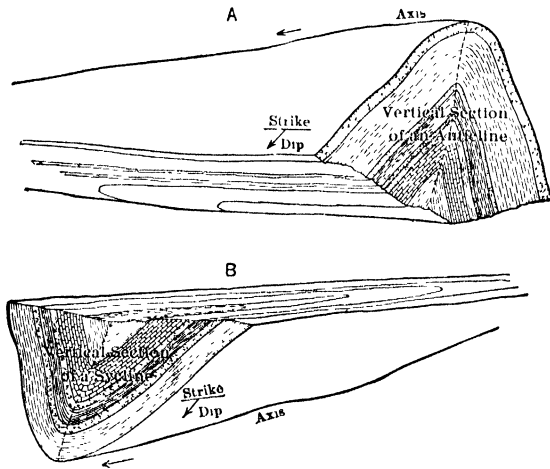

FIG. 70. — A, anticlinal fold; B, synclinal fold. (Modified from Willis.)

Synclines. — These are folds produced by the beds being bent in a downward flexure, so that they dip from both sides towards the bottom of the trough (Fig. 70). They vary in the same manner as anticlines.

A single or isolated fold sometimes occurs (as in some West Virginia oil districts), but as a rule the area of disturbed strata will show a group or series of connecting anticlines and synclines, which are either broad and open, or narrow and compressed, the beds in the latter case being frequently twisted and contorted in the most complex manner.

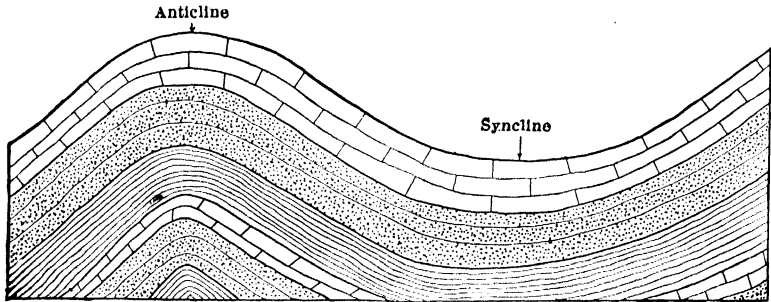

FIG. 71. — Section showing anticline and syncline.

The Appalachian Mountains of the eastern United States form a typical example of this type of structure (Fig. 71 and Plate XXI).

Monocline. — A *monocline* fold is a single bend or curvature in strata which lie at different levels on opposite sides of the bend, but have the same general direction of dip (Fig. 72). It is the simplest kind of

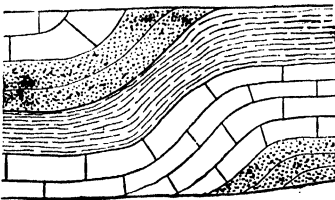

FIG. 72. — Monocline fold.

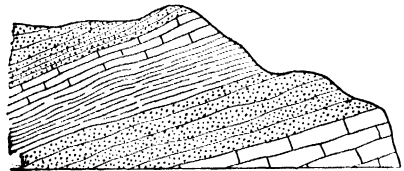

FIG. 73. — Section showing monocline attitude of beds.

flexure, and is generally observed in regions of horizontal or gently dipping beds. Folds of the monocline type are developed on a large scale in the high plateau region of the West, and the gently dipping beds of the Coastal Plain province in the eastern United States furnish a good illustration of the monocline attitude of strata.

Other types of folds. — The *quaquaversal* or dome-shaped fold is a special case of the anticline, in which the beds dip outward in all directions from a central point (Fig. 74).

The *centroclinal* fold or structural *basin* is a special case of a syncline, in which the beds dip inward from all sides towards a central point (Fig. 75).

Both domes (quaquaversal folds) and basins (centroclinal folds) are regarded as modifications of normal anticlines and synclines, and are not very common structural forms.

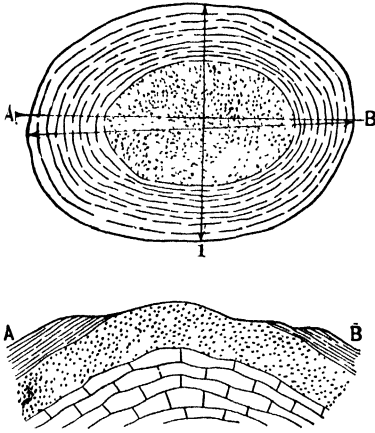

FIG. 74. — Plan and section of quaquaversal fold.

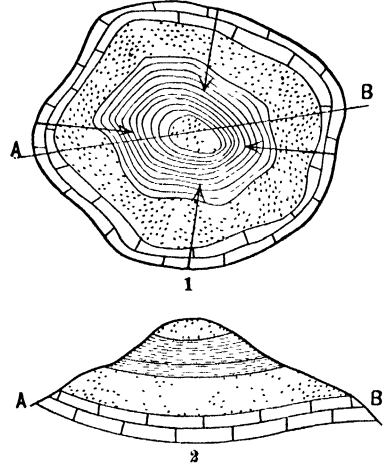

FIG. 75. — Plan and section of centroclinal fold.

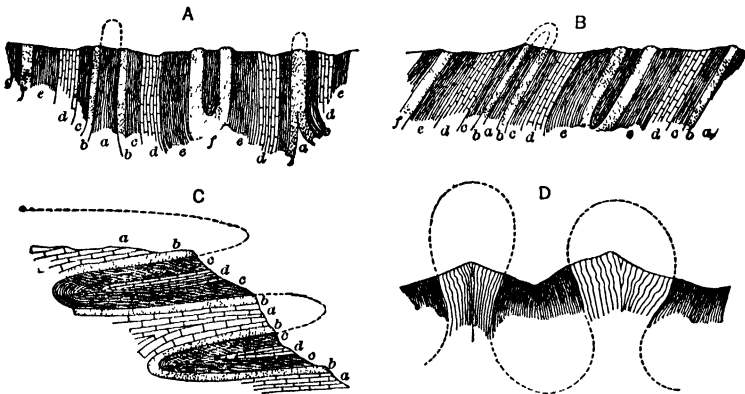

FIG. 76. — (A) Isoclinal folds, upright; (B) isoclinal folds, inclined; (C) isoclinal folds, recumbent; (D) fan structure, upright. (Willis.)

When the disturbed beds over any considerable area have been raised into a broad arch composed of minor folds, such a complex of folds is known as an *anticlinorium* (Plate XIX, Fig. 1). Conversely, when the beds have been depressed into a broad trough composed of subordinate folds, it is termed a *synclinorium* (Plate XIX, Fig. 2). In other words, the terms *anticlinorium* and *synclinorium* refer to composite arches and troughs, to which, when simple, Dana has applied the terms *geanticline* and *geosyncline*.

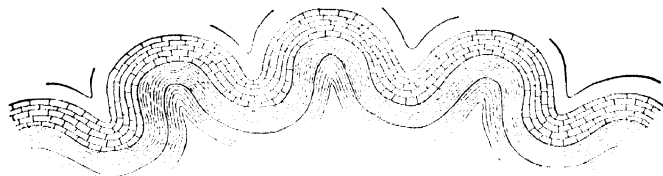

PLATE XIX, FIG. 1. — Ideal section of an upright normal anticlinorium. (After Van Hise.)

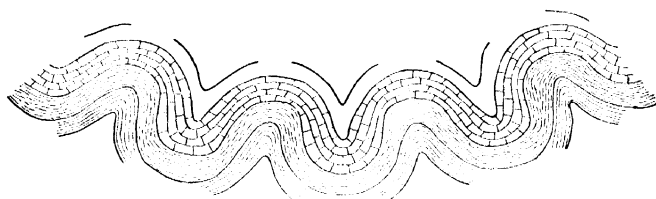

FIG. 2. — Ideal section of an upright normal synclinorium. (After Van Hise.)

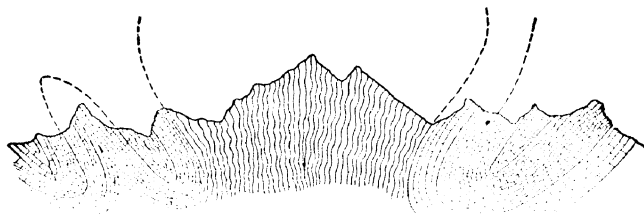

FIG. 3. — Generalized fan fold of the central massif of the Alps. (After Heim.)

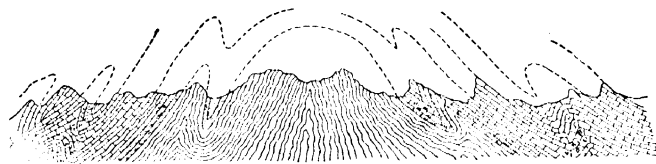

FIG. 4. — General section of roof structure in the central massif of the Alps. (After Heim.)



PLATE XX, FIG. 1. — Contorted strata in Chickamauga limestone near Ben Hur, Va. (Va. Geol. Survey, Bull. II-A.)

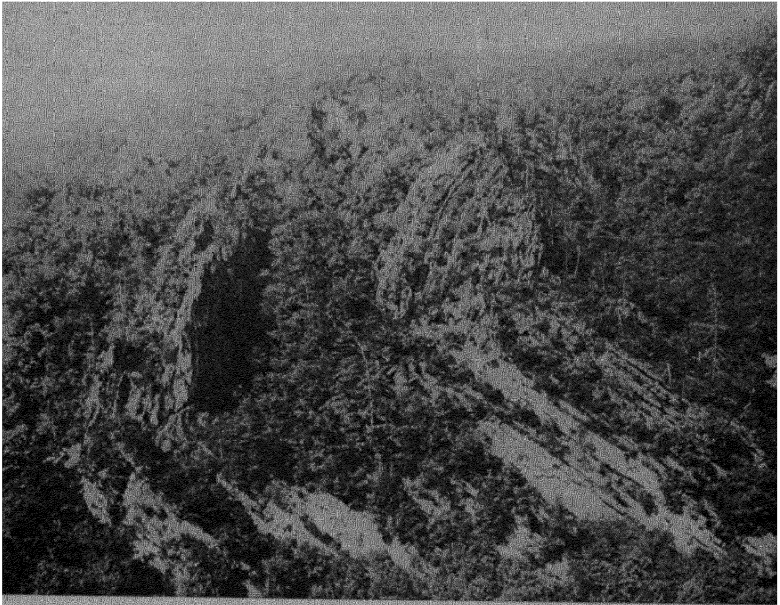

FIG. 2. — Folded quartzite, Eagle Mountain, Botetourt Co., Va. (Va. Geol. Survey, Bull. II-A.)

Folds whose beds have been so compressed that the limbs are parallel are known as *isoclinal* (equal inclination) (Fig. 76, A-C). When eroded to a general level the beds of isoclinal folds present a continuous and uniform dip, so that they appear as a single succession of inclined beds, and may be difficult of interpretation. In such a region of folded and eroded rocks the same bed may be repeated many times at the surface, and unless carefully studied the observer may readily be deceived in the number of independent beds. In regions of complex folding like the Alps, a double series of isoclinal folds has developed, so that the axial planes of the minor folds converge downward on the two sides of a central anticline, producing a type of convoluted structure known as *fan structure* or *fold* (Plate XIX, Fig. 3). The Mont Blanc range is a good example.

Minor folds are frequently developed in weak beds like slate or shale by shearing between two more competent beds like quartzite. Such folds are the result of differential movement between the two competent beds, and are designated *drag folds* (Leith). *Parallel folds* show no thickening or thinning of the beds; the bedding surfaces are parallel, but the curvature is not exactly the same in any two beds. *Similar folds* show thickening and thinning of the beds, the bedding surfaces are not parallel, but the curvature is the same for all beds (Leith).

The principal kinds of folds considered above may be classified (1) with reference to the relation of the limbs to each other, and (2) the amount of compression they have suffered. According to the first principle, each kind of fold may be *upright* or *symmetrical* (Fig. 71), *inclined* or *asymmetrical* (Plate XXI, Fig. 2), *overturned* (Plate XXI, Fig. 4), or *recumbent* (Fig. 76), dependent upon the position of the axial plane, whether vertical, inclined, overturned, or recumbent. According to the degree of compression to which the folds have been subjected, we may group them into (a) *open folds* whose limbs are widely spaced (Plate XXI, Fig. 1), in

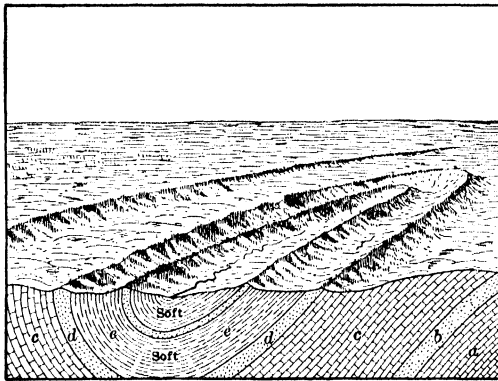

FIG. 77a. — Eroded synclinal fold. (After Willis.)

which the amount of compression has been moderate, resulting in the production of somewhat gentle flexures; and (b) *close folds* whose limbs are in contact (Plate XXI, Fig. 3), characterized usually by sharp flexures with steep slopes, resulting from a high degree of compression.

Folds modified by erosion. — Folds are rarely found in nature with their original forms, but are modified by erosion (Fig. 77), for as soon as they are lifted above sea level, they become, by reason of their position subject to more rapid erosion than the surrounding areas.

The erosion of folded rocks develops characteristic topographic features. In large folds composed of beds of different degrees of resist-

ance to erosion, the hard beds stand up as ridges (Figs. 77 *a* and *b*) and the weak ones mark the position of valleys. Further modification of the surface results from continued and prolonged erosion. Ordinarily anticlines are eroded more rapidly than synclines which seem to offer greater resistance to erosion. Hence in folded strata that have been exposed to erosion for a long period of time, the greatly eroded anticlines form the lower belts or areas, and the more resistant synclines the higher ones.

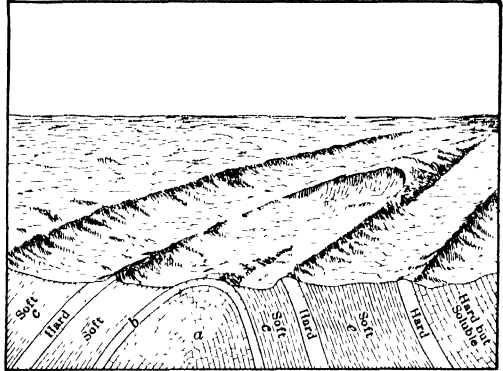

FIG. 77*b*. — Eroded anticlinal fold. (After Willis, U. S. Geol. Surv.)

In some areas of folded rocks that are of great geologic age, such as the

Piedmont region of the eastern United States, the folds have been completely truncated by erosion and the surface everywhere reduced

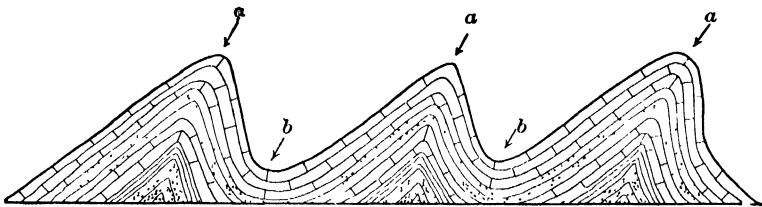

FIG. 78. — Tilted folds.

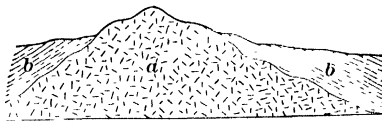

FIG. 79. — Eroded fold, showing igneous rock (*a*), and shales (*b*).

approximately to a common general level. In such regions the determination of folded structure cannot be based on topography, but is determined by careful records made of dips and strikes in field study.

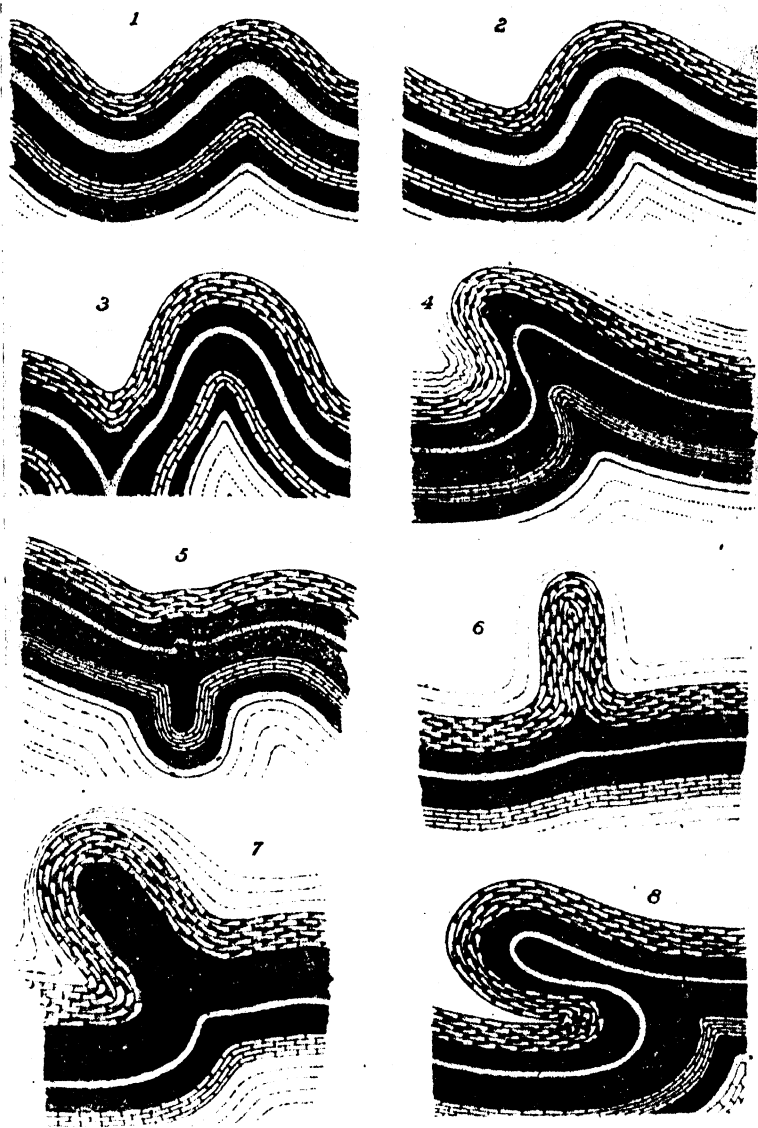

PLATE XXI. — Types of folds: (1) Symmetrical or upright open fold; (2) unsymmetrical or inclined fold, open; (3) symmetrical or upright fold, closed; (4) unsymmetrical fold, closed, and overturned; (5) syncline showing a keel; a carinate syncline; (6) carinate anticline, the lower strata remaining flat; (7) carinate anticline, overturned; (8) carinate anticline, or recumbent fold. (Willis.)

Relation of Folding to Engineering Operations

Tunneling. — Folded rocks sometimes show considerable fracturing along the axis of the fold. In the case of an anticline these fractures diverge upward (Fig. 80), while in a syncline they diverge downward.

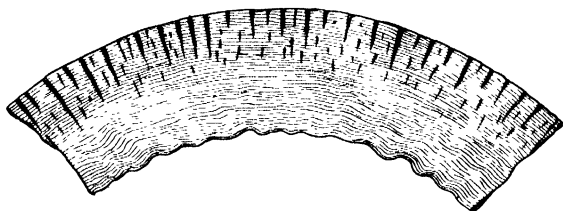

FIG. 80. — Ideal section of bent rock stratum showing fracturing along convex surface and compression along concave surface. (After Van Hise, U. S. Geol. Survey, 16th Ann. Rept.)

Where a tunnel is driven along the crest of a fold (Fig. 81), much trouble may be experienced from shattered rock, and it may be necessary to line it from end to end. In the case of a syncline additional trouble may be caused, even with moderate fracturing, because the blocks bounded by fracture planes are like inverted keystones and are liable to drop out. The fractures along the crest of a fold may cause additional trouble by serving as channelways for surface waters.

In driving tunnels in areas of folded rocks the engineer should give careful attention to the geologic structure since neglect to do so has sometimes led to costly mistakes.

The tunnel may be aligned parallel or oblique to the bedding or foliation planes, or it may be parallel or oblique to the axis of an anticline or syncline, or it may cross a fault or crush zone.

Where then it is driven across any zone of fractured rock it is necessary to line it, partly to prevent the overlying rocks¹ from falling, and partly to keep out water which is likely to follow zones of fracture, whatever may be their cause.

If the tunnel is driven through horizontal or undisturbed rocks, the structural relations are apt to be such that the kind of rock to be re-

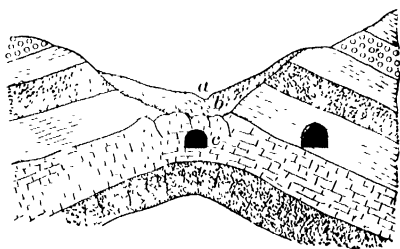

FIG. 81. — Section showing relation of tunnel to anticlinal fold.

¹ See M. Mathieu, The Rove Tunnel, Amer. Inst. Min. and Met. Engrs., Separate No. 1211-M., Feb. 1923.

moved is the same throughout the length of the tunnel, unless the section is penetrated by intrusive igneous rocks.

If the rocks are folded the problem is different, and it then becomes necessary to work out the geologic structure (see p. 219) and the kind of rocks to be penetrated, so as to calculate approximately the yardage of each kind to be removed. This may not be so difficult in the case of folded sedimentary rocks, but in metamorphic ones, such as the railroad engineers have sometimes had to deal with in the Alps, the problem is sometimes quite complex.¹

An anticlinal ridge might appear on rapid inspection to be composed of a single kind of rock, whereas the central portion of the arch might be rock of a totally different nature, firmer or looser, than the outer shell. Indeed large anticlines may be composed not of a single type of rock but of several kinds.

A still different case might be that of a monoclinical ridge, in which the beds, though tilted, all dip in the same direction.

Water may be a cause of serious troubles at times in folded rocks.² In most cases it is surface water, even though it is warm. Such water finds various channelways, such as the spaces between the foliation planes of schists, the bedding planes of stratified rocks, or solution channels in limestones. Evidence supplied by surface examination and drill cores, may occasionally lead the geologist to suspect which of the beds to be encountered are likely to yield subsurface flows.³

Finally, strongly folded rocks may be under great strain, so that when the tunnel is driven, there results a movement or yielding of the rock which may express itself by bulging of the tunnel floor, or shelling off of slab-shaped sharp-edged pieces. According to Lauchli this may occur during construction or several months later, as in the case of the Simplon, Rieken, Weissenstein and other tunnels.

Quarrying. — The position of folded beds likewise affects quarrying operations. Thus in dipping beds of sandstone, marble, and limestone it may be more desirable to work the quarry floor on a slant parallel

¹ See the following: Lauchli, *Tunneling* (McGraw-Hill Book Co.); Schmidt, C., *Die Geologie des Simplongebirges und des Simplon Tunnels*, Rektorats Program der Universität, Basel, für die Jahre 1906 and 1907; Brandau, K., *Das Problem des Baue Langer Tiefliegender Alpentunnels und die Erfahrungen beim Baue des Simplon tunnels*; Schweizerischen Bauzeitung, Bd. LIII & LIV, 1910; Schmidt, C., *Geologische Begutachtung des Rieken Tunnels*, Buchdruckerei A. Benteli, Bern, 1913; Brunton, Davis, and Davies, *Modern Tunneling*, New York (Wiley and Sons); Hardesty, *Eng. News*, Mar. 6, 1902; Eckel, *Contract Record*, Toronto, Oct. 28, 1914; Busfield, *Jour. Eng. Inst. Can.*, II, No. 4, Apr., 1914.

² See *Tunneling*, p. 352.

³ Berkey, *N. Y. State Mus.*, Bull. 146, 1911.

with the bedding, instead of horizontal, partly because it facilitates the extraction of rectangular blocks.¹

If the beds dip into a hill, the overburden will increase with the distance from the outcrop, even though the hill surface itself does not rise. Consequently instead of removing too much overburden it may be better to work the quarry by underground chambers. In the United States this has only been practiced in the case of a few marble and slate deposits, some beds of cement rock, and gypsum.

If the dip of the beds rises with the hill the thickness of overburden does not necessarily increase.

Moderately tilted beds can be worked along the strike as long shallow quarries, and with very steep dip it is often possible to work the quarry as a steep-walled cut, removing the desired beds and leaving the worthless ones standing. This is done in some marble, natural cement rock, and clay deposits.

With intense folding the rock may also be so fractured that the deposit contains few or no large blocks.

Ore deposits.—The crushed rock along the crests of folds sometimes plays an important rôle in the formation of ore deposits, since the cavities between the crushed fragments sometimes serve as spaces for the deposition of ore. (Lead and zinc ores of southwest Virginia.)

Mining.—The position of folded beds may influence the method of mining to be employed, as in the anthracite region of Pennsylvania. Intense folding may also shatter the rocks to such an extent as to make the roof unsafe, and require much timbering.

Relation of dam foundations to inclined and folded rocks.²—Dams must frequently be built on bedded or folded rocks, some beds of which, intercalated with impervious ones, may be porous. The structure planes of the rocks may parallel or may cross the length of the dam, and they may be inclined at any angle, forming in some cases close folds (anticlines and synclines). (1) When possible the dam should parallel the strike of the beds, and be so placed as to have an apron of an impervious bed under the edge of the dam. Dip of the beds may be upstream or downstream, but upstream dips are usually regarded as the more favorable against leakage. If the dam is located on a fold the structural conditions are most favorable against possible loss through percolation of the water on the upstream side of an anticline and the downstream side of a syncline. (2) When the engineer must build the dam across the structure of the rocks, regard should be had in its alignment for

¹ Bowles, U. S. Bur. Mines, Bulls. 106 and 124.

² Fox, Cyril S., *Civil Engineering Geology*, 1923, pp. 32-36.

the least number of defects, such as degree of dip of the beds, possible percolation channels which cross under the dam, texture and general character of the beds or layers of rock. Gently dipping beds will expose fewer bedding planes through which water will percolate under the dam than steeply dipping or vertical beds. If porous beds occur further leakage will take place. Fine-grained sandstones and similar rocks should not condemn the site for the dam unless open joints and other fractures are present, which form the most common cause of leakage from reservoirs.

Field Observations¹

It is frequently necessary for the engineer to make field observations in order to work out the geologic structure, to determine the thickness and cubic contents of a series of beds, or to calculate the depth of a given bed below the surface at a given point. This involves making certain measurements, the method of doing so being explained below.

Angular Measurements.— In all regions except those in which the bedding planes are approximately horizontal, or in which only massive crystalline rocks occur, many determinations of strike and dip must be made. This involves the measurement of vertical angles, which may be done with a clinometer attached to the compass, or with spirit level and vertical circle (Abney hand level or Brunton compass). Less frequently, angular measurements are required for the determination of land slopes or heights of inaccessible objects.

In determining dip angles the edge of the clinometer may be placed directly upon the sloping surface to be determined, but care must be exercised that the part of the surface selected actually represents the average slope of the beds, and that the measurement of the angle is not influenced by local irregularities. Also, to obtain the correct dip the edge of the clinometer must be placed on a line exactly at right angles to the *strike*. Where the exposure is such as to permit it, better results can be secured by sighting to the edge of the beds across the edge of the clinometer at such a distance that several feet will be covered and the average dip obtained. Care must be taken to have the eye as near as possible in the extension of the plane whose inclination is being measured, and to sight on a horizontal line.

Land slopes may be measured with a clinometer when they can be seen in profile, but elsewhere by means of a vertical circle, approximately with the Abney level or Brunton compass, and accurately with a transit or telescopic alidade.

Vertical Measurements.— The means employed for determining differences in elevation will be varied according to the conditions and degree of accuracy required. The instruments most used are (a) the aneroid, (b) the hand level, (c) the wye level, and (d) the telescope with vertical circle.

Determination of thickness of beds.— In the study of areal, stratigraphic, and structural geology, the thickness of beds must be determined at many points. The character of the topography and of the outcrops, and inclination of the beds, will determine the method employed.

¹ The authors have quoted freely from Hayes, Handbook for Field Geologists, Wiley and Sons, N. Y., 3d ed., 1921, by Sidney Paige.

The simplest case is where the beds are approximately horizontal and the slopes are steep. Under such conditions it is necessary only to measure the vertical distances between upper and lower limits of the stratigraphic units by aneroid, hand level, or wye level, depending on the degree of accuracy required. If the slope on which the section is made is very steep — 30° or more — dips of 3° or less may be neglected.

If the beds dip, three factors must be determined — (1) dip angle, (2) slope angle, and (3) distance across the beds normal to the strike; and three cases occur — (a) with surface horizontal, (b) with surface sloping and beds dipping into the slope, and (c) with surface sloping and beds dipping with the slope. These three cases are shown in Fig. 83, from which it is seen that:

- (a) Thickness of beds A to $B = aB = AB \times \sin BAA$.
- (b) Thickness of beds B to $C = bC = BC \times \sin (CBe + cBb)$.
- (c) Thickness of beds C to $D = cD = CD \times \sin (fCf - fCD)$.

The dip angle ($BAA = cBb = fCf$) is measured directly with the clinometer; the slope angles (CBe and fCD) are either measured directly or obtained from the difference in elevation, which is the slope distance into the sine of the slope angle, *i.e.*,

$$\sin CBe = \frac{Ce}{BC};$$

$$\sin fCD = \frac{fD}{CD}.$$

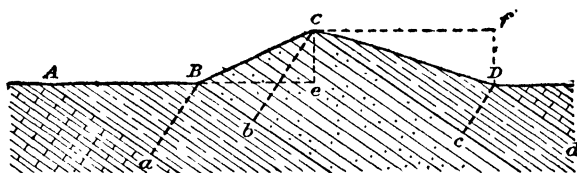

FIG. 82. — Diagram illustrating determination of thickness of beds by trigonometric method. (After Hayes.)

These results may be expressed in the following rules:

- (1) Where the surface is horizontal, the thickness equals the distance across the dipping beds multiplied by the sine of the dip angle.
- (2) Where the surface slopes and beds dip into the slope the thickness equals the distance across the beds multiplied by the sine of the sum of dip and slope angles.
- (3) Where the surface slopes and beds dip with the slope the thickness equals the distance across the beds multiplied by the sine of the difference of dip and slope angles.

A modification and improvement of the Hayes method given below (page 162) has been devised by Hewett, who says: "It is essentially similar to the method recommended by Hayes, but depends upon the height to one's eye as a unit of measure."¹

"The accuracy of the method depends largely on the facility with which the observer readily assumes the same posture, but also on the identification of the point which he is to occupy next. After many measurements of sections ranging from 500 to 2000 feet thick, the writer found that the sum of a number of such units is generally within 5 per

¹ For a description of Hewett's method, see *Econ. Geology*, Vol. XV, No. 5, 1920; *Hayes' Handbook for Field Geologists*, 3rd ed., by Sydney Paige, 1921, pp. 26–27.

cent of the total thickness accurately measured by telescopic alidade and stadia, and rarely deviates 10 per cent from such thicknesses, even in rough regions.”

If the traverse is made oblique to the strike of the rocks, an additional factor is introduced. This problem has been worked out by numerous workers, each in his own particular way. Palmer¹ and Mertie² have recently published graphic solutions. The trigonometric solution of this problem is embodied in the following formula:

$$t = s(\sin \alpha \sin \delta \cos \sigma + \cos \delta \sin \sigma)$$

where

t = thickness of strata;

s = distance on slope between beginning and end points of the traverse;

α = azimuth angle between strike of beds and direction of traverse;

δ = angle of dip of strata;

σ = angle of slope between beginning and end points of the traverse.

To facilitate calculations a table of natural sines and tangents is given on page 165.

With increasing dip the horizontal measurement becomes relatively more important than the vertical, and where the dip becomes approximately 90° the difference in elevation between limits of the beds may be neglected and the true thickness will be represented by the horizontal distance measured at right angles to the strike of the beds.

A convenient method of determining the thickness of beds, without calculation, when the angle of dip and horizontal distance across the outcrop normal to the strike are known, is by the use of the diagram shown in Fig. 83. The horizontal rulings correspond to degrees. Any convenient scale may be adopted for the spaces between vertical rulings, as 1, 10, 50, or 100 feet. To determine the thickness of beds, find the horizontal line corresponding to the dip angle and follow it to the right for a distance corresponding to the measured distance across the outcrop on the scale selected. If the distance coincides with a curved line the latter is followed to the top of the diagram, where the thickness is determined directly by the distance between it and the left margin, the same scale being used. If the point falls between two curved lines, the measurement is made to a point at the top of the diagram having the same relation to these lines.

A convenient method for the direct measurement of thickness in making detailed sections, particularly on steep slopes or with steeply dipping beds and where exposures are nearly continuous, is as follows: To the upper end of a rod of convenient length — 5 feet is about right for a man of ordinary height — is fastened a short arm to form a right-angled T. A zigzag jointed 5-foot rule may be used instead of the rod. In addition to the rod either (a) a hinged clinometer with level on one arm, or (b) an Abney level, or (c) a Brunton compass is used. The dip of the beds is determined, and if a clinometer is used the arms are opened so that the angle between them is equal to the dip angle. If then, the lower limb of the clinom-

¹ Palmer, H. S.: *New Graphic Method for Determining the Depth and Thickness of Strata and the Projection of Dip*. U. S. Geol. Survey, Prof. Paper 120-G, 1918.

² Mertie, J. B., Jr.: *Graphic and Mechanical Computation of Thickness of Strata and Distance to a Stratum*. U. S. Geol. Survey, Prof. Paper 129-C, 1922, pp. 39-52.

TABLES AND FORMULAS

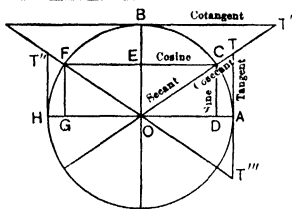
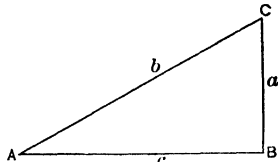

Diagram illustrating circular functions.

SOLUTION OF TRIANGLES



Right triangle.

$$\sin A = \frac{a}{b}, \quad \cos A = \frac{c}{b}, \quad \tan A = \frac{a}{c}.$$

$$C = 90^\circ - A. \quad b = \sqrt{a^2 + c^2}. \quad c = \sqrt{(b+a)(b-a)}.$$

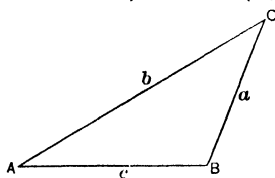

Oblique triangle.

TABLE II. — NATURAL CIRCULAR FUNCTIONS

°	Sine.	Tang.	Cosine.	Cotang.	°
0	0.0000	0.0000	1.0000	Infin.	90
1	0.0175	0.0175	0.9999	57.2900	89
2	0.0349	0.0349	0.9994	28.6363	88
3	0.0523	0.0524	0.9986	19.0811	87
4	0.0698	0.0699	0.9976	14.3007	86
5	0.0872	0.0875	0.9962	11.4301	85
6	0.1045	0.1051	0.9945	9.5144	84
7	.1219	0.1228	0.9926	8.1444	83
8	0.1392	0.1405	0.9903	7.1154	82
9	0.1564	0.1584	0.9877	6.3138	81
10	0.1737	0.1763	0.9848	5.6713	80
11	0.1908	0.1944	0.9816	5.1446	79
12	0.2079	0.2126	0.9782	4.7046	78
13	0.2250	0.2309	0.9744	4.3315	77
14	0.2419	0.2493	0.9703	4.0108	76
15	0.2588	0.2680	0.9659	3.7321	75
16	0.2756	0.2868	0.9613	3.4874	74
17	0.2924	0.3057	0.9563	3.2709	73
18	0.3090	0.3249	0.9511	3.0777	72
19	0.3256	0.3443	0.9455	2.9042	71
20	0.3420	0.3640	0.9397	2.7475	70
21	0.3584	0.3839	0.9336	2.6051	69
22	0.3746	0.4040	0.9272	2.4751	68
23	0.3907	0.4245	0.9205	2.3559	67
24	0.4067	0.4452	0.9136	2.2460	66
25	0.4226	0.4663	0.9063	2.1445	65
26	0.4384	0.4877	0.8988	2.0503	64
27	0.4540	0.5095	0.8910	1.9626	63
28	0.4695	0.5317	0.8830	1.8807	62
29	0.4848	0.5543	0.8746	1.8041	61
30	0.5000	0.5774	0.8660	1.7321	60
31	0.5150	0.6009	0.8572	1.6643	59
32	0.5300	0.6249	0.8480	1.6003	58
33	0.5446	0.6494	0.8387	1.5399	57
34	0.5592	0.6745	0.8290	1.4826	56
35	0.5736	0.7002	0.8192	1.4282	55
36	0.5878	0.7265	0.8090	1.3764	54
37	0.6018	0.7536	0.7986	1.3270	53
38	0.6157	0.7813	0.7880	1.2799	52
39	0.6293	0.8098	0.7772	1.2349	51
40	0.6428	0.8391	0.7660	1.1918	50
41	0.6560	0.8693	0.7547	1.1504	49
42	0.6691	0.9004	0.7431	1.1106	48
43	0.6820	0.9325	0.7314	1.0724	47
44	0.6947	0.9657	0.7193	1.0355	46
45	0.7071	1.0000	0.7071	1.0000	45

Given.	Re-quired.	Formula.
A, B, a	b	$b = \frac{a \sin B}{\sin A}.$
A, a, b	B	$\sin B = \frac{b \sin A}{a}.$
C, a, b	B	$\tan B = \frac{b \sin C}{a - b \cos C}.$
a, b, c	A	$\text{If } s = \frac{1}{2}(a+b+c).$
		$\sin \frac{1}{2} A = \sqrt{\frac{(s-b)(s-c)}{bc}}.$
a, b, c	Area	$\text{or } \cos \frac{1}{2} A = \sqrt{\frac{s(s-a)}{bc}}.$
		$\text{Area} = \sqrt{s(s-a)(s-b)(s-c)}$
A, B, c	Area	$\text{Area} = \frac{1}{2} bc \sin A.$

CIRCLES

Circumference = $2\pi R$. Area = πR^2 . $\pi = 3.1416$

°	Cosine.	Cotang.	Sine.	Tang.	°
---	---------	---------	-------	-------	---

eter is held firmly on the top of the T rod and the rod is inclined until the upper limb is horizontal, the lower limb will be in the plane of bedding projected upward toward the observer. By sighting down the limb the bed in whose plane it lies is determined and the beds between this plane and the foot of the rod have a thickness equal to its length. The foot of the rod is now moved up to this bed and again brought into position so that the upper limb of the clinometer is horizontal and the

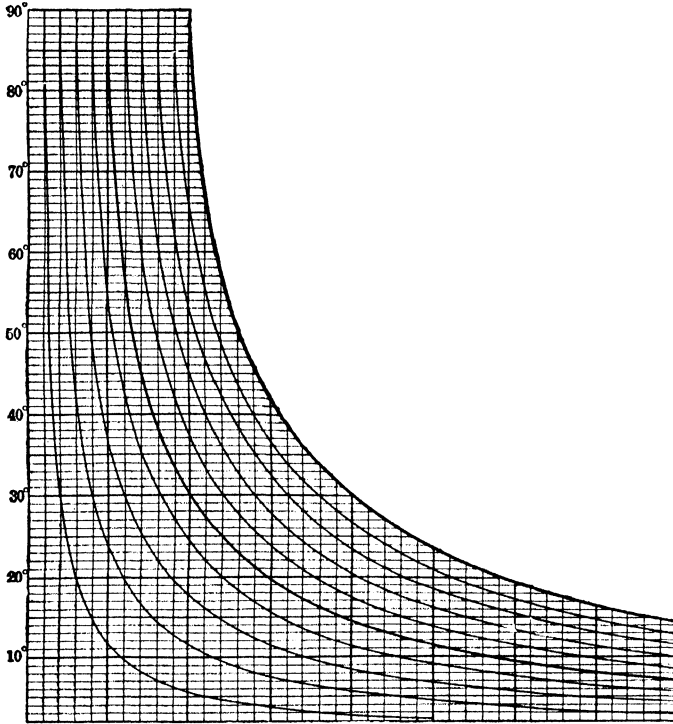

FIG. 83. — Diagram for use in determination of thickness of beds by graphic method. (After Hayes.)

rod is at right angles to the bedding, and a new point is obtained by sighting down the lower limb. Count is kept of the unit thicknesses and the total thickness between determined limits is obtained with no calculation except a multiplication of the length of the rod into the number of sights taken. The method is very similar to the use of the hand level for obtaining elevations, and becomes identical with it when the dip becomes zero.

When the Abney level or the Brunton compass is used the method is the same, except that the vernier arm carrying the level is set at a point on the divided circle corresponding to the dip angle.

Where surface exposures are nearly or quite continuous, so that it is not necessary to follow stream channels, and where dips are steep and variable, sections should be measured as nearly as possible at right angles to the strike. In order to

get the best exposures it is generally necessary to make occasional offsets along the strike, following some easily identifiable bed or contact. Measurements along the strike need not be made with the same degree of accuracy as those normal to the same. The notes of such a traverse may conveniently be kept in tabular form, a page of the notebook being ruled into columns for (1) number of the station, (2) character of rocks, (3) distance (measured on the slope), (4) single angle (U when the slope is up in the direction of traverse and D when it is down), (5) altitude (or elevation with reference to any assumed datum), (6) dip angle (P' when the dip is in the direction of the traverse, and B when the reverse), (7) strike, and (8) thickness. All columns except the last should be filled as the traverse proceeds, and where direct measurements can be made the thickness should be recorded also. Columns 3 to 6 contain the necessary data for computing thicknesses by the methods given above, if they cannot be measured directly.

In case it is necessary to make surface measurements diagonally across the strike, the distance normal to the strike is determined by the solution of a right-angled triangle, the line traversed being the hypotenuse (h) and the angle which this line makes with the strike being an adjacent angle (c). The side (B) opposite this known angle will be the distance on the slope normal to the strike — that is,

$$B = \frac{h}{\sin c}$$

In making sections of steeply inclined and poorly exposed beds, the observed dips at the nearest exposures often show wide variation. A convenient method of obtaining approximate thicknesses under such conditions is as follows: Measure horizontal distances as nearly as possible at right angles to the strike, locating and measuring as many dips as possible. Construct a normal profile to scale and plot upon it all dips projected in their proper horizontal relations, as in Fig. 84. Extend the dips in straight lines above and below the profile. At the intersection of each dip line with the surface profile draw a line at right angles and extend it until it intersects the dip lines on either side. The thickness of the beds between any two observed exposures, as A and B , will be equal to one-half the sum of the lines intersected between the dip lines above and below the profile; that is,

$$\text{Thickness of beds } A \text{ to } B = \frac{Ab' + aB}{2}$$

$$\text{Thickness of beds } C \text{ to } D = \frac{Cd' + cD}{2}, \text{ etc.}$$

These values can be scaled off directly from the diagram. The construction is based on the assumption that the dip varies uniformly from A to B , C to D , etc.,

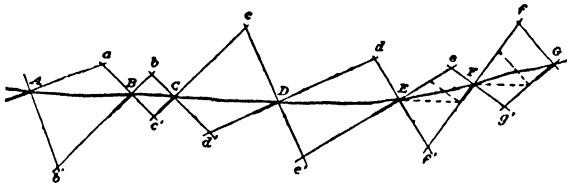

FIG. 84. — Diagram illustrating determination of thickness of beds by construction method. (After Hayes.)

which may or may not be the case. Moreover, the results are too large if the observed dips are at different elevations and converge downward, and they are too small if they diverge. Thus in the section represented by Fig. 84 the thicknesses will

be approximately correct from *A* to *E*, too small from *E* to *F*, and too large from *F* to *G*. The method is applicable therefore only where the profile is approximately horizontal and should be employed only where the exposures are not sufficient for accurate measurement.

Determination of depth of beds.—It is frequently necessary to determine in the field the depth of a particular bed or horizon at a distance from its outcrop, or to determine the distance from the outcrop at which a coal bed or oil sand reaches a given depth. The problem may be solved by graphic or trigonometric methods.

The graphic method involves the construction of a section at right angles to the strike. Dips are plotted on the profile drawn to scale and showing the thicknesses of intervening beds as determined by the methods given in paragraphs 1 to 8 above.

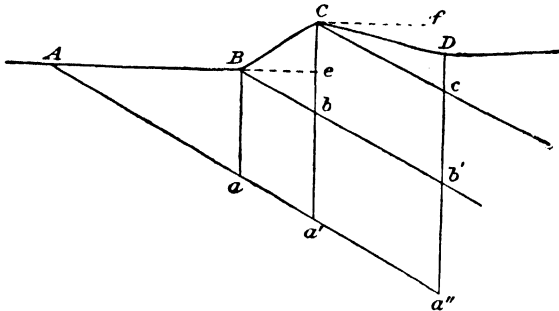

FIG. 85.—Diagram illustrating determination of depth of beds by trigonometric method. (After Hayes.)

The depth of a bed at any point, or the distance from the outcrop at which any bed reaches a given depth, can then be scaled off directly from the section.

By the trigonometric method three cases occur: (1) where the surface below which the depth is to be determined is horizontal; (2) where the surface slopes and the beds dip into the slope; and (3) where the surface slopes and the beds dip with the slope. The three cases are shown in Fig. 86, from which it is seen that:

$$(1) \text{ Depth of bed } Aa \text{ at } B = Ba = AB \times \tan BAA.$$

$$(2) \text{ Depth of bed } Bb \text{ at } C = Cb = \frac{BC \times \sin eBb}{\cos eBb}.$$

$$(3) \text{ Depth of bed } Cc \text{ at } D = Dc = \frac{CD \times \sin fCc}{\cos fCc},$$

and depth of bed *Aa''* at *D* = *Da''* = *Da* + *Cb* + *Dc*.

In this figure *AB*, *BC*, and *CD* are the surface distances normal to the strike of the beds; *BAA*, *eBb*, and *fCc* are the dip angles; *Cbb* is the sum, and *DCc* is the difference of dip and slope angles.

For convenience in determinations where the surface is approximately horizontal, a table giving depths of a bed for various angles of dip and distances from outcrop is given below."

The following table, condensed from Hayes, gives the depth of a stratum below horizontal surface for various distances and depths. For intermediate distances between those given, interpolations can be easily made.

DEPTH OF STRATUM BELOW HORIZONTAL SURFACE FOR VARIOUS DISTANCES AND DIPS

Dip angle, degrees	Feet				$\frac{1}{2}$ mile (1320 ft)	$\frac{1}{4}$ mile (2640 ft)	1 mile (5280 ft)
	100	200	500	1000			
1	1.75	3.50	8.75	17.5	23.04	46.08	92.16
2	3.49	6.98	17.45	34.9	46.09	92.18	184.4
3	5.24	10.48	26.20	52.4	69.18	138.4	276.7
4	6.99	13.98	34.95	69.9	92.30	184.6	369.2
5	8.75	17.50	43.75	87.5	115.5	230.5	461.9
6	10.51	21.02	52.55	105.1	138.7	277.4	555.0
7	12.28	24.56	61.40	122.8	162.1	324.2	648.3
8	14.05	28.10	70.20	140.5	185.5	371.0	742.0
9	15.84	31.68	79.20	158.4	209.1	418.2	836.3
10	17.63	35.26	88.15	176.3	232.8	465.6	931.0
11	19.44	38.88	97.20	194.4	256.6	513.2	1026
12	21.26	42.52	106.30	212.6	280.6	561.2	1123
13	23.09	46.18	115.45	230.9	304.7	609.4	1219
14	24.93	49.86	124.65	249.3	329.1	658.2	1316
15	26.80	53.60	134.00	268.0	353.7	707.4	1415
16	28.68	57.36	143.40	286.8	378.5	757.0	1514
17	30.57	61.14	152.85	305.7	403.6	807.2	1614
18	32.49	64.98	162.45	324.9	428.9	857.8	1716
19	34.43	68.86	172.15	344.3	454.3	908.6	1817
20	36.40	72.80	182.00	364.0	480.4	960.8	1923
21	38.39	76.78	191.95	383.9	506.7	1012	2027
22	40.40	80.80	202.00	404.0	533.3	1067	2133
23	42.45	84.90	212.25	424.5	560.3	1121	2241
24	44.52	89.04	222.60	445.2	587.7	1175	2351
25	46.63	93.26	233.15	466.3	615.5	1231	2462
26	48.77	97.54	243.85	487.7	643.7	1287	2575
27	50.95	101.90	254.75	509.5	672.6	1345	2690
28	53.17	106.34	265.85	531.7	701.8	1404	2807
29	55.43	110.86	277.15	554.3	731.7	1463	2927
30	57.74	115.48	288.70	577.4	762.1	1524	3048

Where the slope is gentle and great accuracy is not required, this table may be used by adding to the depths given the difference in elevation between the outcrop and the point at which the depth is desired, the difference in elevation being positive when this point is higher than the outcrop and negative when it is lower. The errors will generally be well within the limits of accuracy of measurement, and the formulæ given above need not be employed except with steep slopes."

JOINTS

Introduction. — All hard and firm rocks, regardless of kind, are traversed by fractures called *joints*. These may be observed in almost any natural or artificial exposure of hard rock, and constitute division planes which separate the rock into large and small blocks of regular or irregular shape. Jointed structure is of importance in many ways because of its relation to quarrying and general engineering operations, especially tunneling and mining. Joints are also of importance in promoting rock weathering (Chap. IV), in the circulation of ground water (Chap. VI), in the formation of mineral veins (Chap. XVII), etc.

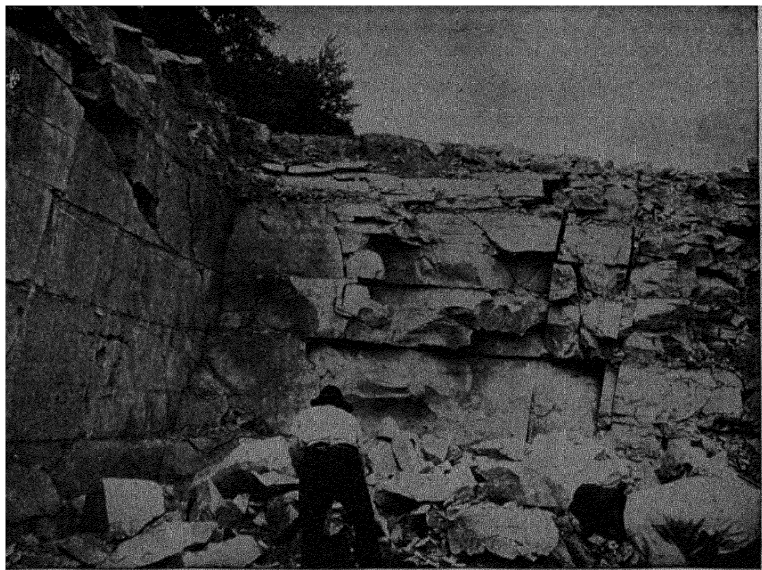

PLATE XXII, FIG. 1. — Limestone showing horizontal bedding, and one set of vertical joints. The flat face of the quarry is a joint surface of a second set. Cement rock quarry, Milwaukee, Wis. (H. Ries, photo.)



FIG. 2. — Faulted pegmatite dike in granite, near Boulder, Colo. (H. Ries, photo.)
(170)

General characters.—Joints traverse the rocks in different directions and at various angles, and in most areas at least two systems are observed (Plate XXII, Fig. 1), the fractures of each system being roughly parallel to each other, but in regions of great disturbance three or more sets of joints are not uncommon. The spacing of joints of a single set may vary, being measurable at times in yards, at others in inches, and this is a matter of practical importance since it governs the size of dimension blocks that can be extracted from a given quarry.

Joints may be either vertical (Pl. XXII, Fig. 1), or horizontal (Pl. XXIX, Fig. 1), and even intermediate positions are not uncommon. In igneous rocks, horizontal joints are sometimes mistaken for stratification planes. (See granite, Chapter XI.) The best joint exposures are commonly seen on vertical surfaces, for on horizontal ones the overlying mantle of residual clay or other unconsolidated material may conceal them.

Some joints are closed, others are open, and in rocks like limestone they may be widened by solution. In such cases they become less conspicuous when followed downward. In many quarries much stone bordering the joints has to be rejected at times because of its unsound or weathered character.

Classification of joints.—Joints may be grouped as *tension* and *compression* joints to indicate their relation to stresses, whether formed by tension or compression. In folded rocks they may be grouped into *strike joints* and *dip joints* to indicate their parallelism, or nearly so, in direction to the strike and dip of beds. Joints are also known as *major* or *master joints* when of persistent development, and as *minor joints* when of short extent.

Joints in sedimentary rocks.—There are usually developed in bedded rocks two systems of major joints intersecting each other at approximately right angles, and perpendicular to the bedding planes. They may be of slight development and confined to individual beds or they may be extensive and traverse a series of beds of considerable thickness. They frequently end at the contact of two unlike rocks; thus joints which traverse limestone or sandstone may end where shale begins.

Joints in fine-grained rocks like some hard shales are apt to be more perfect than in coarse-grained rocks like some sandstones. In strongly folded rocks joints are more numerous and more closely spaced than in less disturbed rocks. In flat beds joints are commonly perpendicular

to the bedding, and hence vertical. In steeply dipping beds, the joints meet the beds at oblique angles.

Joints in igneous rocks. — Joints in igneous rocks frequently show less regularity than those in sedimentary ones, and their arrangement at times is very irregular. In igneous rocks like granite, which have extensive use as building stone, two systems of joints, a vertical set and a horizontal set (Pl. XXIX, Fig. 1), and, in many places, a third or diagonal set, are developed. These may be widely spaced or closely spaced. In some granites the joints are so closely spaced that dimension stone cannot be extracted, but the rock breaks into numerous small blocks when quarried. Considerable variation is noted in the development of the vertical joints, which are conspicuously developed in most cases but may be few and scarcely visible in others.

Horizontal joints which divide the rock into sheets are frequently strongly developed in granite, and are usually parallel to the rock surface. Sheet jointing is so well developed in some granites that it closely resembles stratification in sedimentary rocks. In flat surface exposures they approach a horizontal position; in gently arched exposures they have approximately the same degree of curvature as that of the rock surface; and in steep domes they are correspondingly steep, observing parallelism with the doming surface. They are usually more conspicuous at and near the surface, and become less prominent below. Ordinarily they separate the rock into thinner sheets at or near the surface, and into thicker sheets at greater depth. (Pl. XXIX, Fig. 1.)

In dense and compact igneous rocks like basalt, which occur in dikes and lava flows (sheets), there is often developed a regular form of prismatic jointing known as columnar structure, as shown in Plate VIII. The columns may be vertical or horizontal, sometimes bent and curved, and may vary greatly in size (length and diameter). They are perpendicular to the principal cooling surface, so that in lava flows and horizontal intruded sheets they are vertical, while in dikes they are apt to be horizontal. The joints in igneous rocks, especially columnar ones, are due chiefly to contraction of the cooling magma and are tension joints.

Jointing in metamorphic rocks. — Because of the conditions under which they are formed, metamorphic rocks usually show much jointing, which, as a rule, is less perfect than in sedimentary rocks. In the more massive types of metamorphic rocks like gneiss the jointing resembles that in granite, while in the thinly foliated or schistose types like slate it more clearly resembles that of sedimentary rocks.

Joints in Relation to Engineering Work

Few perhaps realize the important bearing which joints have on engineering problems, hence their relation to some of the more important ones is briefly discussed.

Quarrying operations. — Joints facilitate the extraction of stone, and the expense of quarrying hard ones like granite would be considerably increased were it not for their presence. While of benefit on the one hand, they will on the other serve to limit the size of the dimension blocks that can be extracted. An otherwise good stone may be so broken by jointing as to be useless for any purpose except road material and the various forms of crushed stone. Joints also permit the entrance of surface water, which in some cases causes more or less weathering of the rock along them.

A quarry face should be parallel or at right angles to the joint planes in order to avoid waste, for if it crosses the joints obliquely, some of the rocks will break out in triangular blocks.

Rock slides. — In unsupported rock masses, outcropping on hill-sides, or exposed in the sides of quarries or underground workings, joints sometimes act as slipping planes, causing slides. If the water gets into the joint cracks and freezes the action is sometimes hastened.

Reservoir construction. — Since joints serve as water passages, engineers constructing dams or reservoirs should see that where the masonry work joins the rock, the joints are not sufficiently numerous to permit leakage. Grouting is sometimes necessary to close them up. Very often, the joints are more numerous and open close to the surface than they are at greater depth. Joints and other fractures form the most common source of leakage from reservoirs. The danger here mentioned becomes most serious in limestone formations (Chapter IV)¹ because of enlargement of the joint and other spaces through solution of the rock by percolating waters.

Water supply. — In regions of igneous and metamorphic rocks, that are usually dense, any supply of subsurface water must collect most exclusively in joint fissures, which often form easy channelways for their circulation. But even here there are limitations as to depth at which we may obtain a reasonable water supply (Chapter VI). For example, it has been shown in the Piedmont region of crystalline rocks that the conditions favorable to water supply lessen rapidly below 250 or 300 feet, for the reason that the joints above this depth are more open.

¹ See also Du Toit, South African Soc. Civ. Engrs., 1922.

Ore deposits.— Because joints sometimes serve as channels for subsurface waters they are at times of importance as structures (spaces) for the deposition of mineral matter and the formation of mineral veins. Recognition of this occasional relation of ore veins to joints has in some instances facilitated the development of the ore, or search for further ore bodies in those districts where it applies.

FAULTS

Definition.— A *fault* may be defined as a fracture in the rocks along which displacement of one side with respect to the other has taken place, parallel to the fracture. The amount of displacement may vary from a few inches to many thousand feet, and the movement may be sudden, slow, or recurrent.

Significance.— Faults are not restricted to any group or kind of rocks, but may traverse all, and are structures of fundamental importance in all regions where they occur. They may, and sometimes do, greatly affect and modify the surface topography; they frequently exercise an important control on surface and subsurface waters; they may become fissure veins by filling and replacement along their courses, and hence are of great economic importance in mineralization or the formation of ore deposits (see Chapter XVII); and they may prove to be sources of great disaster in loss of time and money, in mining operations, unless properly interpreted and understood. They may further prove at times a source of serious trouble in some engineering operations, especially in reservoir and tunnel construction.

Fault terms.¹— For clearness of discussion it is desirable to have terms to indicate the several characteristics of faults. These are as follows:

A *closed fault* is one in which the two walls of a fault are in contact.

An *open fault* is one in which the two walls of a fault are separated. The same fault may be closed in one part and open in another.

The *fault space* is the space between the walls of an open fault.

A *fault surface* is the surface of a fracture along which dislocation takes place, and if without notable curvature it is called a *fault plane* (Fig. 90).

¹ The terminology of faults has been much confused, and that used in this work has been proposed by a committee appointed by the Geological Society of America to report on a proper nomenclature of faults. Their conclusions, which will no doubt be adopted by American Geologists are given in full in Bull. Geol. Soc. Amer., 1913, vol. 24, p. 163-186.

A *fault line* is the intersection of a fault surface with the earth's surface, or with any artificial surface of reference, such as the floor of a tunnel. When a fault is made up of slips on closely spaced surfaces, with more or less deformation of the intervening rock, it is called a *shear zone*. The name would also be applicable to *breccia zones* (Fig. 87) which characterize some faults, especially those of the thrust type.

The *fault breccia* (Fig. 87) is the breccia frequently found in the shear zone, and more especially in the case of thrust faults. *Gouge* is the fine-grained impervious clay-like material, which is often found between the walls of a fault. The breccia and gouge are the result of the crushing of the wall rocks during slipping. In the actual movement the blocks may scratch and polish the surfaces of one another, these striated surfaces being *slickensides*. A *horse* (Fig. 86) is a mass of rock broken from one wall and caught between the walls of the fault.

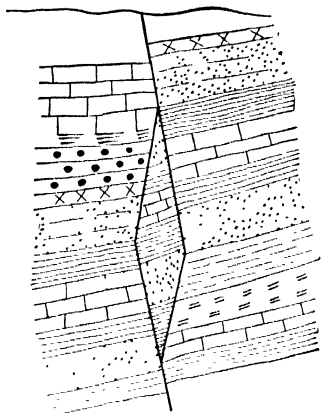

FIG. 86.—Section showing “horse” developed by faulting.

The *fault strike* is the direction of the intersection of the fault surface, or the shear zone, with a horizontal plane. The *fault dip* (Fig. 90) is the inclination of the fault surface, or shear zone, measured downward from a horizontal plane. It is never greater than 90 degrees. The *hade* (Fig. 90) is the inclination of the fault surface, or shear zone, measured from the vertical; it is the complement of the dip. A fault *hades* to the side towards which it dips. The *hanging wall* (Fig. 90) is the upper wall of the fault. The *foot wall* (Fig. 90) is the lower wall of the fault.

A *multiple fault* is used to designate a group of parallel faults of fairly close spacing, with the intervening rock not distorted. Shear zones would not be applicable in this case. An *auxiliary fault* is a minor fault ending against the main fault. It is often the boundary of a dropped wedge.

Criteria for faulting. — It is of first importance perhaps to determine the existence of a fault, and then to discover the direction and amount of the movement. Various criteria can be used, but one alone seldom proves conclusive, and some may be developed under conditions other

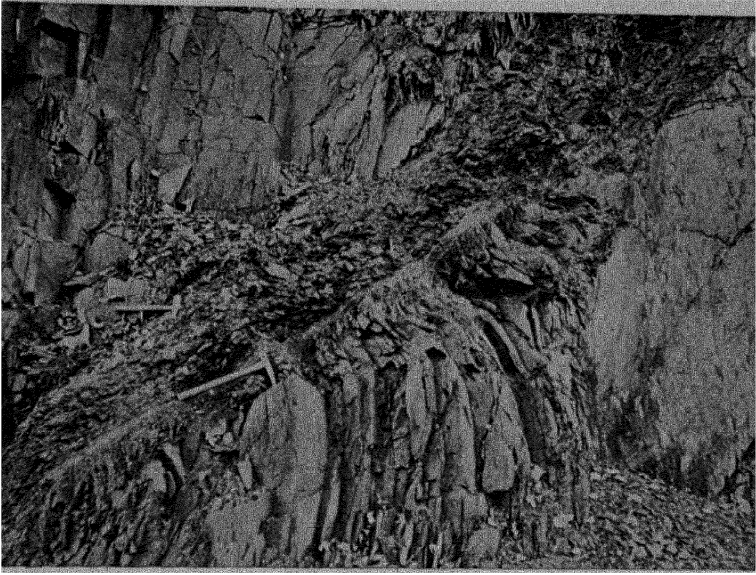

PLATE XXIII, FIG. 1. — Fault in Ordovician slates near mouth of Slate River, Va.
The two hammers mark boundary of fault breccia. (T. L. Watson, photo.)

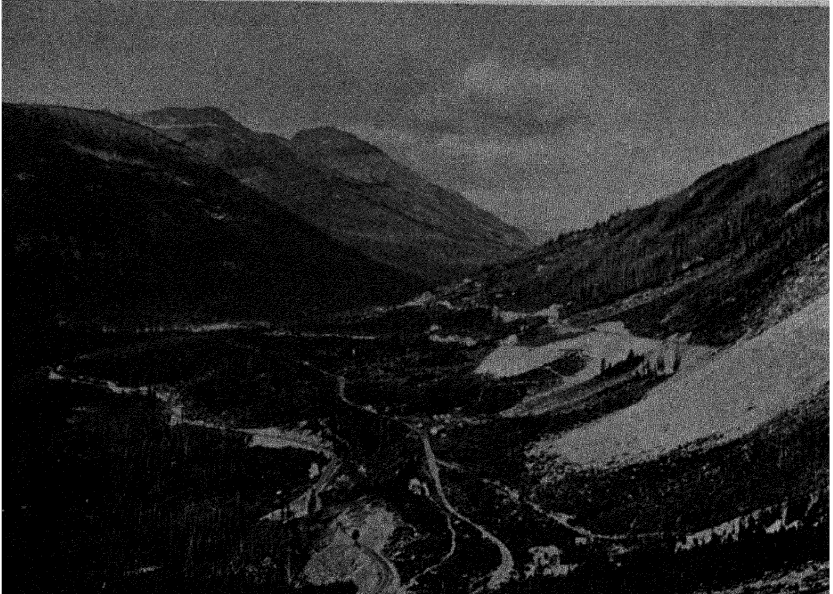

FIG. 2. — View from Mount Stephen, near Field, B. C., looking toward pass at Hector. On right slope are seen the two ends of the upper tunnel crossing fault zone in mountain on right. On extreme left, slope of Mt. Ogden, where the lower spiral tunnel is in massive limestone.

than faulting. The criteria which may be applied are: (1) Displacement of dikes (Plate XXII, Fig. 2), veins or beds; (2) brecciation along line of fracture (Fig. 87, and Plate XXIII, Fig. 1); (3) striations (slickensides) on fracture surfaces; (4) the presence of gouge; (5) the presence frequently of a shear zone or division of the rock into slices parallel to the plane of the fault; (6) fault scarps (Fig. 90), seen where faults are recent, and erosion has not had time to reduce them; (7) drainage lines sometimes developed along fault lines.

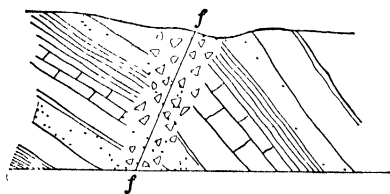

FIG. 87. — Faulting accompanied by brecciation.

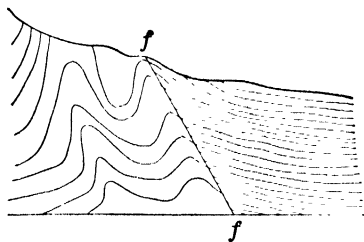

FIG. 88. — Normal faulting showing distortion of shale.

It must not be assumed that in the field the two walls of a fault will be found in contact at the surface; in fact the fault line may be covered by surface material and its presence is determined from the structural relationships of the surrounding outcrops, on opposite sides of the fault line. All faults however do not extend to the surface.

Kinds of Fault Displacement

Slip. — The word “*slip*” indicates the displacement as measured on the fault’s surface; the qualifying words refer to the strike and dip of the fault. The *slip* or *net slip* (Fig. 89) is the distance measured on the fault surface, between two formerly adjacent points situated, respectively, on opposite walls of the fault. It would be represented by a straight line in the fault surface connecting those two parts after the displacement.

The *strike-slip* (Fig. 89) is the component of the slip parallel with the fault strike, or the projection of the net slip on a horizontal line in the fault surface. The *dip-slip* (Fig. 89) is the component of the slip parallel with the fault dip, or to the projection of the slip on a line in the fault surface perpendicular to the fault strike. The strike-slip and the dip-slip are rectangular components of the net slip. The *trace-slip* is the component of the slip parallel with the trace of a bed, vein, or other surface on the fault plane.

The *perpendicular slip* is the component of the slip at right angles to the trace of a bed, vein, or other surface on the fault plane. The trace-slip and the perpendicular slip are rectangular components of the net slip.

Shift. — It frequently happens that a fault has not a single surface of shear, but consists of a series of small slips on closely spaced surfaces, and in some faults the strata in the neighborhood of the fault surface

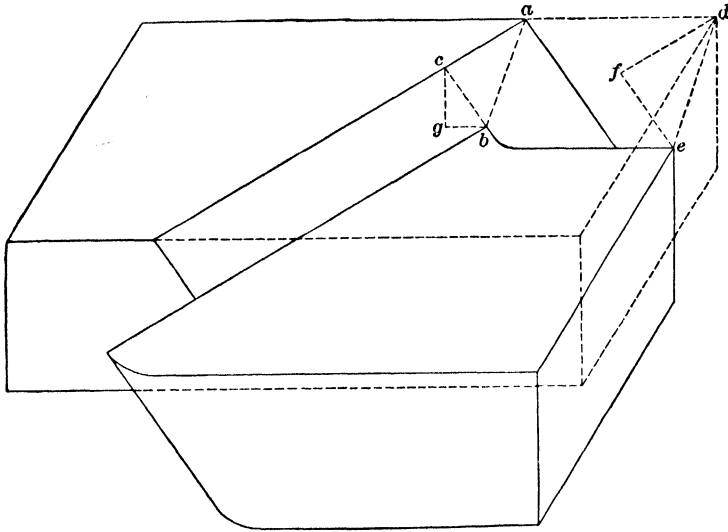

FIG. 89. — Faulted block with parts named. ab = slip or net slip; cb = dip-slip; ac = strike-slip; de = net shift; fe = dip-shift; fd = strike-shift; gb = heave; gc = throw. The fault movement is *oblique*. (After Reid.)

are bent, so that the relative displacements of the rock masses on opposite sides of the fault may be quite different from the slip and not even parallel with it. The word *shift* (Fig. 89) is used to denote the relative displacements of the rock masses situated outside the zone of dislocation; the qualifying words relate to the strike and dip of the fault with one exception, in which the meaning is clear.

The *shift* or *net shift* (Fig. 89) denotes the maximum relative displacement of points on opposite sides of the fault and far enough from it to be outside the dislocated zone.

The *strike-shift* (Fig. 89) is the component of the shift parallel with the fault strike. The *dip-shift* (Fig. 89) is the component of the shift parallel with the fault dip.

The bending of the strata near the fault may be so great that the direction of the shift is no longer even nearly parallel with the fault surface; it is better, then, to

use the three following compneonts of the shift: The *strike-shift* denotes the horizontal component of the shift parallel with the fault strike, as already defined. The *normal shift* denotes the horizontal component of the shift at right angles to the fault strike. It equals the horizontal shortening or lengthening of the earth's surface at right angles to the fault strike, due to the fault. The *vertical shift* denotes the vertical components of the shift. These components of the shift may evidently be used when the shift is parallel with the general trend of the fault surface.

Throw and heave. — *Throw* (Figs. 89 and 90) is the vertical distance between corresponding lines in the two fracture surfaces of a disrupted stratum, etc., measured in a vertical plane at right angles to the fault strike.

By *perpendicular throw* is meant the distance between the two parts of the disrupted bed, etc., measured perpendicularly to the bedding plane or to the plane of the surface in question. Special terms applied to perpendicular throw are: *Stratigraphic throw* (Figs. 91 and 92), the distance between the two parts of a disrupted bed measured at right angles to the plane of the bed; and *dip throw*, the component of the slip measured parallel with the dip of the strata.

Heave (Figs. 89 and 90) is the horizontal distance between corresponding lines in the two fracture surfaces of a disrupted stratum, etc., measured at right angles to the fault strike.

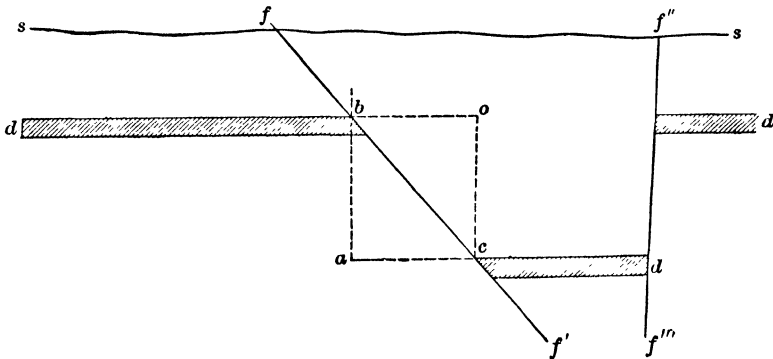

Fig. 90. — Normal fault in horizontal beds. *ss*, surface; *ff'*, fault plane; *db*, up-throw side; *dc*, downthrow side; *cba*, angle of hade or slope; *cbo*, angle of dip; *ab*, throw (also stratigraphic throw in this case); *ac*, heave (horizontal throw); left side of *ff''*, foot wall; right side of *ff''*, hanging wall; *fbc*, fault scarp; *f''f'''*, fault plane (vertical).

The words throw and heave are essential elements of a fault. For example, if a fault were encountered when a coal seam was being worked, it would be important to know how far a drift should be run horizontally and how far a shaft should be opened vertically to reach the other part of the disrupted seam.

Offset. — This is the distance between the two parts of the disrupted stratum measured at right angles to the strike of the stratum, and on a horizontal plane. The term *heave* has been used by some for offset.

Faults in stratified rocks. — Among stratified rocks the character of the displacement of the strata due to a fault is so much influenced by the relation of the strike of the fault to that of the strata that special subclasses may generally be recognized as follows: A *strike fault* (Fig. 98) is one whose strike is parallel to the strike of the beds. A *dip fault* is one whose strike is approximately at right angles to the strike of the beds, or in other words parallel to the dip. An *oblique fault* is one whose strike is oblique to the strike of the beds. These terms are, of course, not directly applicable in regions of unstratified rocks; but they might be used in such regions with respect to the strike of a system of parallel dikes if this were distinctly stated in the description of the faults.

Fault blocks. — Terms applicable to fault blocks are *fault wedge*, *horst*, and *graben* or *trough fault*. A *fault wedge* is a wedge-shaped block between two faults (Plate XXIV, Fig. 1). A *horst* is an upthrown block between two downthrown blocks; while a *graben* or *trough fault* is a downthrown block between two upthrown blocks.

General Classes of Faults

Classification of faults according to direction of movement. — Faults may be classified, according to the direction of movement on the fault

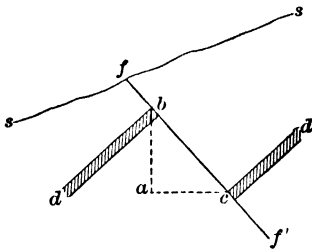

FIG. 91. — Normal fault having against dip of beds. *ab*, throw (vertical); *bc*, stratigraphic throw; others same as Fig. 90.

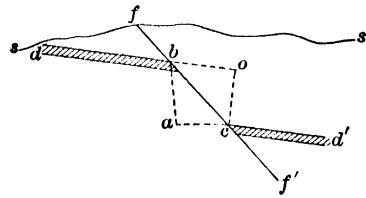

FIG. 92. — Normal fault having with dip of beds. *ab*, throw (vertical); *oc*, stratigraphic throw; others same as Fig. 90.

plane, into the following: *Dip-slip faults*, where the net slip is practically in the line of the fault dip. *Strike-slip faults*, where the net slip is

practically in the direction of the fault strike. *Oblique-slip faults*, where the net slip lies between these directions.

Strike faults. — Most geological textbooks and books on field methods have confined themselves almost exclusively to the discussion of dip-slip faults, and have given little attention to the other two classes.

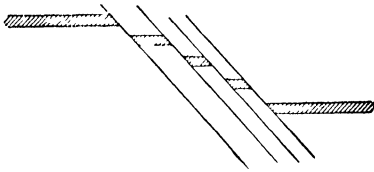

FIG. 93. — Section showing distributive or step faulting.

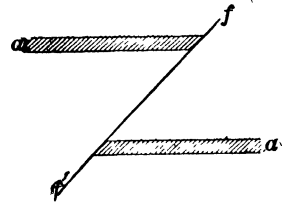

FIG. 94. — Section showing reverse fault.

Normal faults (Figs. 90 to 93), where the hanging wall has been depressed relatively to the foot wall.

Reverse faults (Fig. 94), where the hanging wall has been raised relatively to the foot wall.

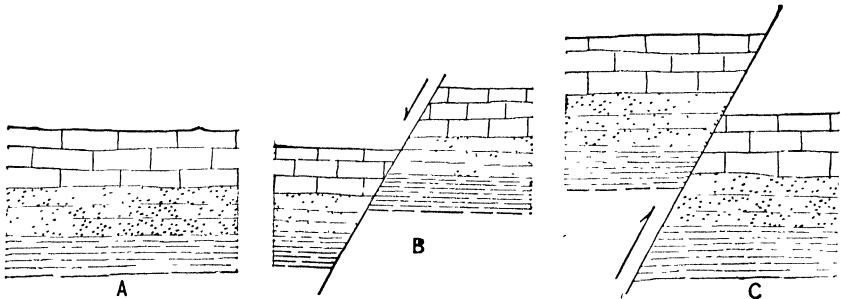

FIG. 95. — Sections showing development of fault, of either normal or reverse character. A, unfractured beds; B, normal fault; C, reverse fault.

Overthrusts are reverse faults with low dip or large hade. In some cases the dip-slip has been enormous, amounting to tens of kilometers. Scott calls them “thrusts” and separates them entirely from faults of high dip; but the word “thrust” has been used for ordinary reverse faults of high dip. R. T. Chamberlin distinguishes between low angle overthrusts approaching horizontality and ordinary reverse faults of higher dip. The word “overthrust” has been very generally used for this kind of fault and is very descriptive. It should be adopted.

Thrust faults are sometimes associated with recumbent or drag folds, as in the southern Appalachians, the Alps, and the Scottish Highlands. Especially notable are the overthrust faults in the Rocky Mountain region of Utah, Wyoming, and Montana.

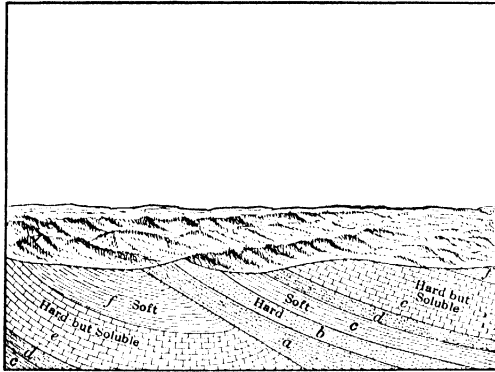

FIG. 96. — Thrust fault. (After Willis, U. S. Geol. Survey, 13th Ann. Report).

Vertical faults, where the dip is 90 degrees (Fig. 90).

The relative displacement has usually been determined by means of a dislocated bed. The horizontal distance between two points on opposite sides of a fault, measured on a line at right angles to the fault strike, is always shortened by a reverse strike fault, lengthened by a normal strike fault, and unchanged in length by a vertical fault.

The expressions “normal” and “reverse” may be used in connection with oblique and dip faults, even when they are strike-slip or oblique-slip faults, provided they are applied to designate the apparent relative displacement of the two parts of a dislocated stratum, or other recognized surface, in a vertical plane at right angles to the fault strike. It very frequently happens that nothing more than the apparent displacement of the strata can be determined, and we recommend the terms “normal” and “reverse” faults as defined be used purely for purposes of description and not for the purpose of indicating extension or contraction, tension or compression, vertical or horizontal forces.

Special classes of faults. — There are two classes of faults which have played such important roles in altering the structure of some regions that they have received special names.

Flaws. — A term applied by Suess to certain faults in which the strike is transverse to the strike of the rocks, the dip high and varying from one side to the other, in the course of the fault, and the relative movement practically horizontal and parallel with the strike of the fault.

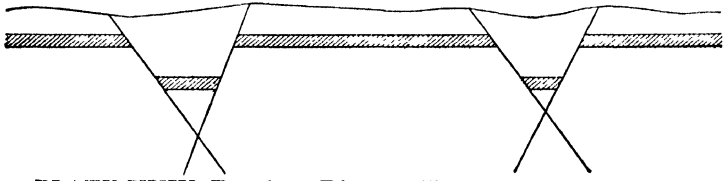

PLATE XXIV, FIG. 1 — Diagram illustrating trough faults.

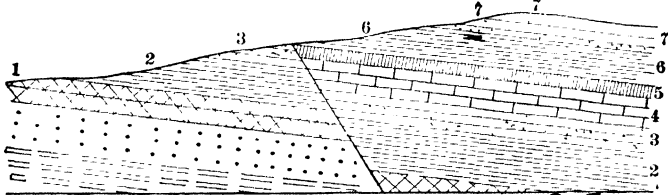

FIG. 2. — Strike fault section, having with dip; cuts out some beds at surface.

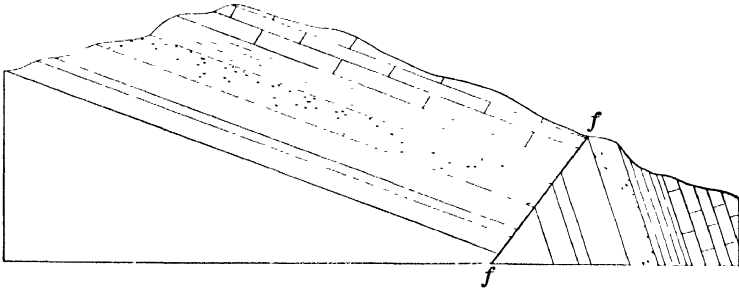

FIG. 3. — Fault showing change of dip.

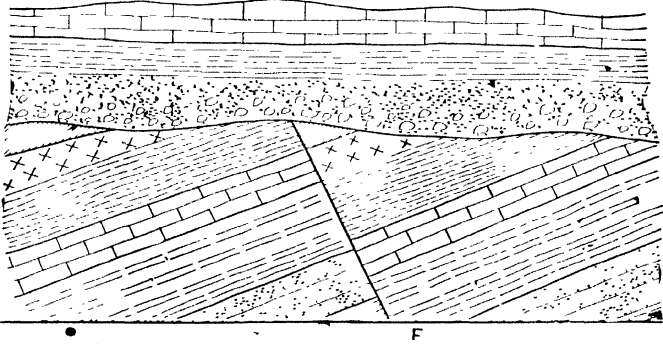

FIG. 4. — Faulting of an unconformable series of beds showing age of fault.

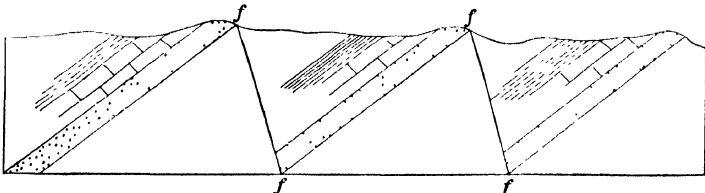

FIG. 5. — Strata repeated by faulting.

Movements on faults. — These may be classified, according to the character of the local displacement, into translatory and rotatory movements.

Translatory movements are those in which all straight lines on opposite sides of the fault, and outside the dislocated zone, which were parallel before the displacement, are parallel afterwards. If at a later date, or even at the time of the displacement, the whole region were tilted, the movement would still be considered a translatory movement, so far as the fault is concerned.

Rotatory movements are those in which some straight lines on opposite sides of the fault and outside the dislocated zone, parallel before the displacements, are no longer parallel after it — that is, where one side of the part of the fault under consideration has suffered a rotation relative to the other side.

No faults of any magnitude exhibit merely translatory movements over their whole lengths. Faults die out and the displacement is not uniform along them, so that there is necessarily some slight rotation, varying in amount in different parts of the fault's course. If we confine our attention to a small part of the fault, we may describe the displacement there as though the rock were rigid; and if the rotation is very small, as if a translatory displacement had occurred, and for conciseness we may use the terms *translatory fault*, or *rotatory fault*, to describe the part under consideration.

Effect of Faults on the Outcrop

The effect of faults on the outcrop (surface) may be of two kinds: (1) Topographic, and (2) geologic.

Topographic effects. — The expression of faults at the surface may be shown in escarpments, distribution of rocks of unequal resistance, drainage lines, etc. Faults frequently exhibit no surface expression, so that their existence might not be suspected. This is apt to be the case in faults which have but slight displacement, or in those having originally moderate or great displacement resulting in the formation of a well-defined fault scarp, erosive processes having reduced the scarp side to an approximate common level with the opposite side. In many cases, however, a scarp that is of gentle or steep slope and of moderate or considerable height, dependent upon the hade and amount of the displacement, results from faulting. The Hurricane fault and the faults of the Basin Ranges are among the best examples of faults showing escarpments. A sequence of surface forms may develop during the progress of erosional work, until the scarp is finally obliterated upon completion of the cycle of erosion.

Again faults may bring together rocks of markedly different or unequal resistance, so that the more resistant rocks will rise above the softer ones, forming a belt of higher ground, the margin of which is marked by the line of dislocation. The juxtaposition of a hard and soft rock is not always proof of faulting, for we might have a soft limestone interbedded normally between two hard sandstone formations. If these had a steep dip, a depression might be worn in the limestone, while the resistant sandstones remained as bordering ridges on either side.

The courses of faults are sometimes marked by lines of springs; also they may become lines of control for surface drainage, the erosion along them developing valleys.

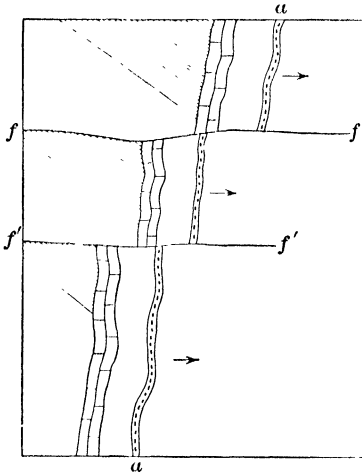

FIG. 97. — Plan illustrating shifting of beds by faulting.

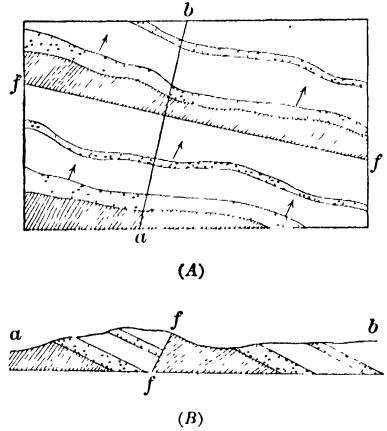

FIG. 98. — (A) Plan of strike fault showing repetition of beds at surface. *ff*, fault. (B) Section along line *ab* normal to strike fault showing repetition of beds.

Geologic effects. — Faults may produce various complications in the outcrops of rocks at the surface.

Strike faults may repeat a given layer or bed at the surface (Fig. 98) or may eliminate or cut it out altogether (Plate XXV, Fig. 2), dependent upon whether the downthrow is against or in the direction of the dip of the beds. Dip faults cause horizontal shift of the outcrops, either forward or backward, according to the direction of downthrow (Plate XXV, Fig. 3). Oblique faults result in offset with overlap if the downthrow is to the left (Plate XXV, Fig. 4), or offset with gap, if the downthrow is to the right (Plate XXV, Fig. 5). The amount of overlap and gap increases with increase of throw and hade, and decreases with increase of dip.

A fault which crosses a fold at right angles to its axis changes the distance between the outcrop of a given bed on opposite sides of the fault; the distance being decreased on the upthrow side of a syncline (Fig. 99), and increased on the upthrow side of an anticline.

Various other complications arise under different conditions, but these will serve to indicate the effect on outcrop which may result from some of the common kinds of faulting.

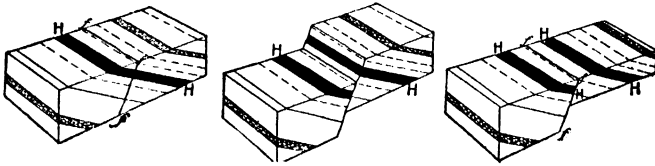

FIG. 1

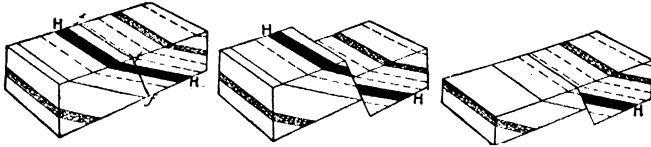

FIG. 2

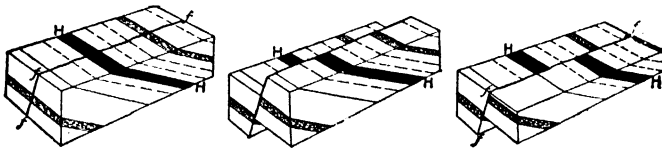

FIG. 3

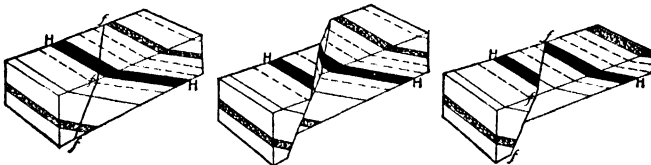

FIG. 4

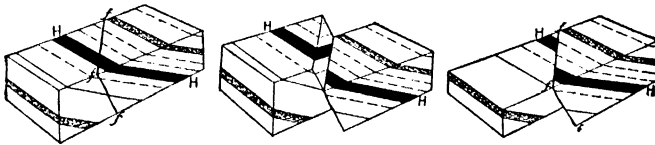

FIG. 5

PLATE XXV. — Diagram showing effects of different kinds of faults on block with monoclinical structure and one coal bed. Fault fissure, *f*. The block is supposed to have been worn off in each case after faulting. FIG. 1. — Repetition of beds by normal strike fault having in opposite direction from dip. FIG. 2. — Cutting out of bed by strike fault having in same direction as dip. FIG. 3. — Horizontal separation of bed, by dip fault whose downthrow side is on farther side of fault plane. FIG. 4. — Overlapping of bed by oblique fault. FIG. 5. — Separation of bed by oblique fault. (Chamberlin and Salisbury.)

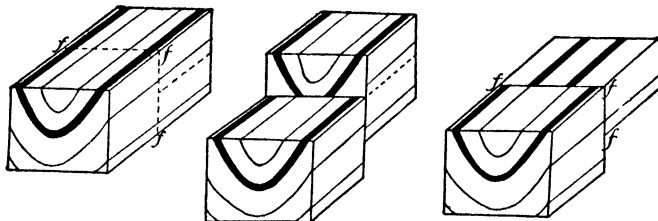

FIG. 99. — Diagram showing effect of faulting on the outcrops of a syncline. (From Chamberlin and Salisbury, College Geology.)

Relation between faults and folds.— From earth movements which result in over-intense folding, folds may pass into faults both

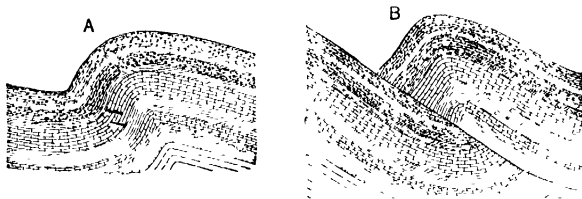

FIG. 100. — (a) Stepfold, showing break in the massive limestone bed which determines the plane of the break-thrust, (b) along which the displacement results from further compression. (Willis.)

vertically and horizontally. Beds involved in such cases often show thickening and thinning, stretching and shortening. Frequently in

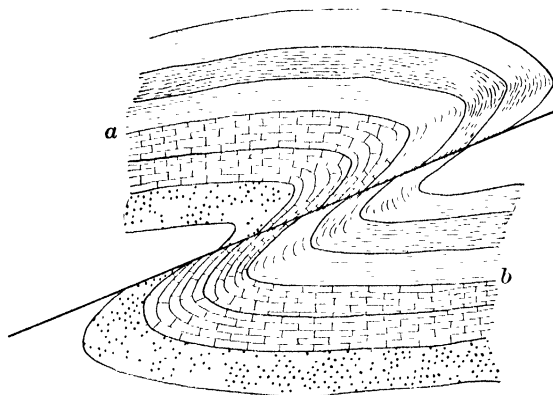

FIG. 101. — Fold passing into a fault. (Van Hise.)

monoclinical folds, these may pass into a fault when followed along the strike. This may be because the fold is so strongly compressed or

drawn out that the flexure disappears and a fault takes its place. Thus in the Kaibab fault of the high plateaus of Utah, a normal fault grades along the strike into a monocline.

In the southern Appalachians overthrust faults are frequently found associated with overthrust folds; also there may be found in the same region excellent examples of distributive faults associated with minute overthrust folds.

Relation of Faulting to Engineering Work

Faulting is not an uncommon phenomenon in many regions of disturbed rocks. It causes engineers trouble not only for the reason that it has in the past disturbed the rock formations, but sometimes because fault movements take place at the present day. Several cases may be noted.

Tunneling. — The importance of having firm solid rock to tunnel through is well recognized, not only as a matter of safety and convenience in working, but for easy maintenance after the tunnel is completed. If, therefore, a rock which has been pierced by a tunnel is much shattered by faulting, it becomes necessary to line the tunnel, at least in the crushed territory. Furthermore, if the fault fissure extends to the surface, it may serve as a channel way for rain waters.

A most interesting case was that developed on the line of the Canadian Pacific Railway between the summit of the pass at Hector, B. C., and Field, B. C., in the valley of the Kicking Horse River. In order to reduce the grade between these points, the road was lengthened and two spiral tunnels were constructed. The upper one of these was in the quartzite of Cathedral Mountain on the south side of the valley (Plate XXIII, Fig. 2), while the other was in the limestone of Mt. Ogden on the north side. Now it happens that a fault of nearly 3000 feet displacement passes between Cathedral Mountain and Mt. Stephen to the west of it, and the upper tunnel lies partly within the shear zone of this fault. This has given much trouble first, because of the shattered

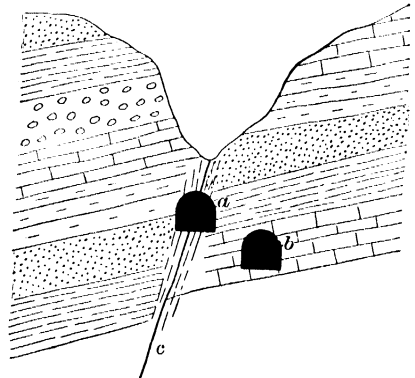

FIG. 102. — Section showing relation of tunnel to fault zone.

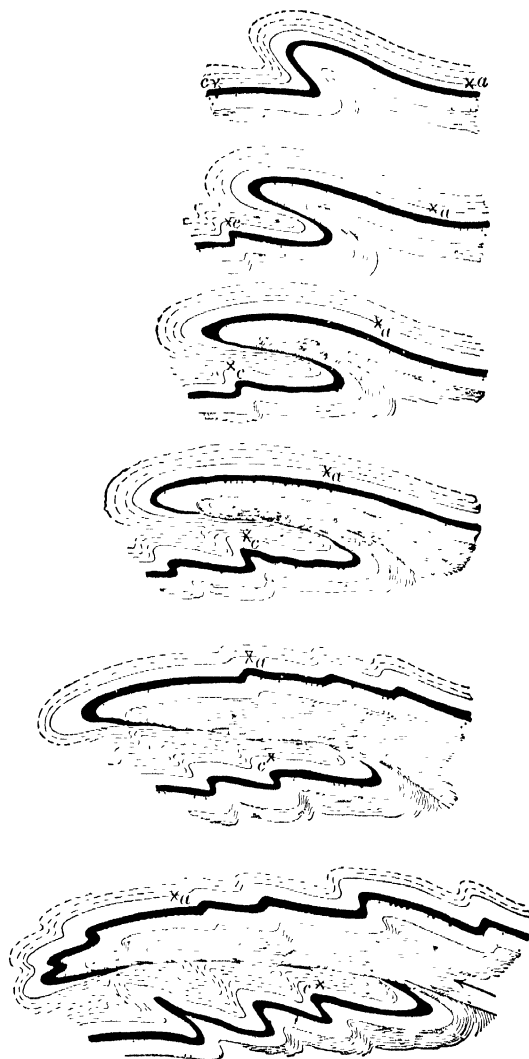

PLATE XXVI.—Sections to illustrate development of overthrust folding and faulting, accompanied by minor drag folds, as inferred from Alpine structure. (After Heim, from Leith's Structural Geology.)

character of the rock, which necessitated lining the tunnel, and second, because of the surface water which ran down along the fissured zone. The lower tunnel in the massive limestone of Mt. Ogden is free from these annoyances.¹

Another interesting case² is that of a tunnel at Franklin, Cal., which follows the soft clay gouge of a thrust fault. The tunnel is timbered, but the swelling of the wet clay dislodges the wooden supports. A geological examination of the ground at the time of the railroad survey might have avoided the trouble.³

Aqueducts. — In aqueduct construction engineers have had to deal not only with past but present faulting. In the selection of a route for the new Catskill aqueduct, in New York state,⁴ much of the construction was tunnel work, especially where it became necessary to cross under river valleys with inverted syphons. Consequently, in the selection of a route which would insure solid rock for as great a distance as possible, much attention was given to the occurrence of faults, which might have shear zones of variable width. Such lines of fracture were encountered at several points.⁵

At times the existence of faults can be inferred or even definitely determined from drill records. If, for example, in boring, the beds encountered are in an order which is known not to be the normal one for the rocks of that region, and the drill also strikes crushed or brecciated zones, faulting may be inferred. Occasionally the drill on meeting these fault fissures is deflected.⁶

In parts of California where fault lines are known to exist, as from San Francisco southward, it is well known that movement along some of these is recurring at not widely separated intervals.

The movement which produced the San Francisco earthquake in 1906 took place along a fault fissure traceable for at least 250 miles, and although having a small horizontal displacement (8 to 20 feet) it did considerable damage. Pipe lines which crossed the fracture, and in one case a water supply tunnel connecting two lakes, were broken.

¹ Oral communication from Prof. J. A. Allan.

² Oral communication from Prof. A. C. Lawson.

³ For other cases of trouble in tunneling caused by faults see also: Lauchli, *Can. Engr.*, Sept. 16, 1915; Davies, *Trans. Amer. Soc. Civ. Engr's.*, LXXX, p. 594, 1916; Brunton, *Tunneling*, New York (Wiley & Sons).

⁴ Berkey, *N. Y. State Museum, Bull.* 146, 1911.

⁵ Berkey, *N. Y. State Museum, Bull.* 225-226, 1921.

⁶ Berkey, *N. Y. State Museum, Bull.* 146, p. 166, 1911.

The recently completed Los Angeles aqueduct, which brings water from Owens Lake to Los Angeles, Cal., must of necessity cross some of these fault lines, and provision has been made to keep repair parts near these lines of fracture for ready use in case any movement occurs along them in the future.

Reservoirs. — In the location of reservoirs care should be taken to avoid locating them over fault fractures, as there is a strong possibility of the water draining off along them, unless they are tight.

Earthquakes. — Fault movements are a frequent cause of earthquakes, and the vibrations set up in the rocks by faulting cause more or less damage, sometimes for a distance of several miles from the fault line. Structures standing on hard rock are less violently shaken (other things being equal) than those on unconsolidated material.

The problem which confronts the engineer in countries subject to such shocks is to determine what type of structure will best resist the disturbance. The question has been given renewed attention in this country since the San Francisco earthquake, and while there exists a difference of opinion, it seems probable that structures which are set firmly on their foundations, and having all their parts well bound together are the most resistant.¹

Coal mines. — In coal fields like some of those of the southern Appalachian region, the beds are not only folded but are also at times displaced by faults. The effect of this is: First, that the two parts of a fractured bed may become completely separated so that the engineer, especially if he lacks geological knowledge, may have difficulty in discovering the continuation of the bed on the other side of the fracture; and second, the coal along the fault is usually badly crushed, and even mixed with rock and dirt.

Ore deposits. — Mining engineers probably have more trouble with faults than any other class of engineers.

Mineral veins are frequently formed by the filling of fault fissures (see Chapter XVII). If, now, there is more than one set of fissures, of different age in a given region, and those of one series are mineralized, while those of the other series are of much less importance, it is highly

¹ See Gilbert and others, U. S. Geol. Survey, Bull. 324, 1907, San Francisco Earthquake and Fire, and Effects on Structures and Structural Materials; Hobbs, Construction in Earthquake Countries, Eng. Mag., XXXVII, p. 1, 1909; Milne, Construction in Earthquake Countries, Trans. Seismol. Soc., Japan, XIV, p. 1, 1889-1890; Hobbs, Study of Damage to Bridges during Earthquakes, Jour. Geol., XVI, p. 636, 1908; Hobbs, Earthquakes, Appleton, New York, 1907; Bull. Seismol. Soc. America.

essential for the engineer to recognize this fact, to avoid following barren leads.

At Butte, Montana, there have been recognized no less than six periods of faulting, the successively later displacements having cut the earlier ones. Since the fractures of the different periods of faulting are not all equally mineralized, and in fact some carry no ore, it becomes necessary for the engineer to work out the relationships of the different sets of displacement.

But aside from this, ore veins and other types of ore bodies are sometimes displaced by one or more later faults, and then the engineer or mining geologist must determine, if possible, the amount and direction of the fault movement in order to find the continuation of the ore body.

Abundant and complex faulting sometimes makes the problem an exceedingly difficult one.¹

Curiously enough engineers sometimes on coming to a fault plane think that the ore has given out, although the evidence of displacement, such as slickensides and breccia, may be present. A simple, and almost self-explanatory case found in a bedded ore deposit in the eastern states

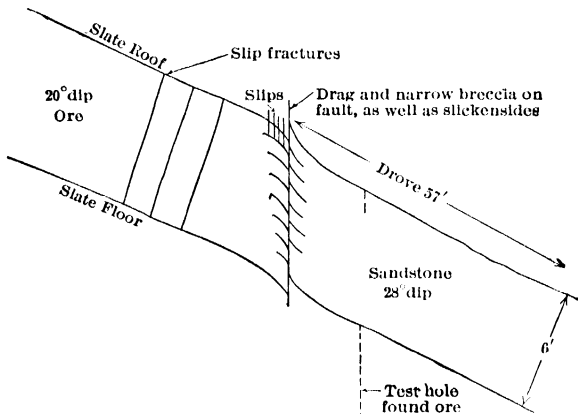

Fig. 103. — Section showing case of bedded ore cut off by fault.

is given in Fig. 103. Many others more or less complex can be found in the literature.

Oil and gas. — Crossing of an oil or gas pool by a fault may sometimes allow these substances to escape to the surface. In the case of the former, however, the oil sometimes changes to asphalt which seals the fissure. Indeed some asphalt veins occur in fault fissures.

¹ See Lindgren, *Mineral Deposits*, p. 114, 1913; Spurr, U. S. Geol. Survey, Prof. Pap. 42, 1905, on Tonopah, Nev.

Submarine cables. — In one case at least faulting appears to have been responsible for the breaking of a submarine cable. This was the breaking of the lines near Valdez, Alaska, during the earthquake shock of Feb. 14, 1908.¹

It is stated that both the Valdez-Sitka and Valdez-Seward cables were interrupted close to the city of Valdez, and well inside Valdez Narrows. The Valdez-Seward cable was broken in four places three-eighths to one and one-eighth miles apart, while the Valdez-Sitka cable was broken in seven places five-eighths to seven-eighths mile apart.

Similar trouble was caused in Porto Rico and Jamaica.² It should be explained however that in this case the breaking of the cable was due to submarine slides started by the earthquake.

Landslides. — As explained in Chapter VII fault fissures which contain clay gouge and become wet and slippery by infiltrating waters may serve as gliding surfaces which cause landslides. Slips of this type were among those encountered in the construction of the Panama Canal.

Quarrying. — Faulting may affect quarrying operations in several different ways.

Rock located in a shear zone may be so badly sheeted or fractured as to be worthless for dimension stone, and, moreover, because of such fracturing surface waters can penetrate the rock causing considerable discoloration, and even decay.

Where a bed of limited thickness is being quarried, dislocation by faulting, even though unaccompanied by any serious shattering, may give trouble in following the rock desired. The limestone and natural rock cement beds of the Rondout, New York, district have been much disturbed by faulting in addition to folding.

If the fault zone is narrow, or if it consists of but a single fracture, it may cause little more trouble than to permit weathering of the stone along its length and breadth.

Determination of Faults.³

“Where exposures are sufficiently abundant the facts necessary for the determination of the direction and extent of a displacement, particularly if it is relatively small in amount, may be observed directly. As a rule, however, the dip of the fault

¹ Tarr and Martin, U. S. Geol. Survey, Prof. Pap. 69, p. 97, 1912.

² Reid and Taber, The Porto Rico Earthquake in 1918, Document 269, House of Representatives.

³ Quoted from Hayes, Handbook for Field Geologists, 1921, revised by Sidney Paige, pp. 33-42. In this connection see also Tolman, Graphical Solution of Fault Problems, Min. & Sci. Press, San Francisco, 1911.

plane and the direction and amount of displacement must be inferred from a number of observations at different localities. Field observations should be made with especial care and completeness in the vicinity of faults, for it is here that the unexpected is always apt to occur.

Dip of fault plane. — It often happens that the contact of rocks on opposite sides of a fault plane cannot be seen at any point, although the fault may be traced for many miles. To afford data for determination of the dip, as many points as possible on the fault should be accurately located both horizontally and vertically. The points should be selected so that the horizontal distances will be as small, and the vertical as large, as possible. Three points properly selected and accurately located will give better results than a larger number less carefully chosen and determined. The best locations are at the bottom of a valley transverse to the fault and on the hills on either side. The three points fix the position of the fault plane, and its dip or the angle it makes with the horizontal may be determined by construction or trigonometric methods. The trigonometric method involves the solution of a number of triangles and the extraction of square roots. Its practical application, therefore, necessitates the use of logarithmic tables, which are not generally accessible in the field. The method by construction is relatively simple and

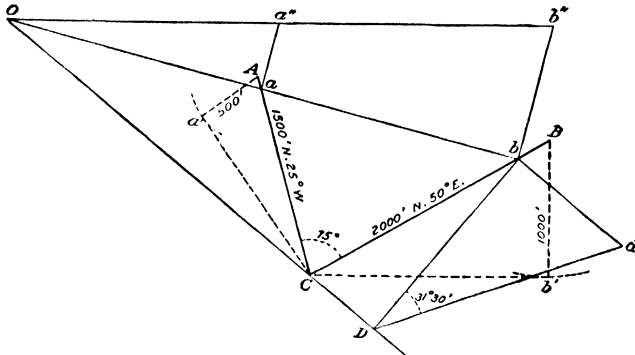

FIG. 104. — Diagram illustrating determination of dip of fault plane. (After Hayes.)

requires only a protractor, dividers, and scale. This method is illustrated in Fig. 104, and is as follows:

Let the three points in the fault plane be *A*, *B*, and *C*. Let *C* be the lowest and *B* the highest, the difference in elevation having been determined. The horizontal or slope distances from *C* to *A* and *B*, and the azimuth of the lines connecting them, have also been determined. Lay off with the protractor the lines *CA* and *CB*, in proper azimuth on the scale adopted. If these lines represent slope distances, project the points *A* and *B* upon the horizontal plane passing through *C*, as follows:

Construct a right triangle (*BCb'*) with *CB* as the hypotenuse and the difference in elevation between *C* and *B* as the perpendicular. Lay off on *CB* a distance equal to the base of this right triangle — that is, $Cb = Cb'$. Determine the point *a* on *CA* in like manner. Draw a line through *a* and *b* and extend it beyond *a*. The triangle *aCb* is the horizontal projection of the portion of the inclined plane included by the lines connecting *A*, *B*, and *C*. If the distances between *C* and *A* and *B* are horizontal distances this projection is not necessary, since the triangle can be drawn at once — in the horizontal plane — and the line completing the triangle will be drawn through *A* and *B*.

At a and b erect perpendiculars equal respectively to Aa' and Bb' , and draw a line through their extremities to its intersection with the line ba extended at O . This point of intersection will be in the horizontal plane and also in the inclined plane. Since C also is in the same horizontal plane and in the inclined plane, a line connecting O and C will be the intersection of these two planes, and hence the *strike* line. From the horizontal projection of either of the points, as b , let fall a perpendicular to D on this strike line OC extended. From b draw bd perpendicular to bD and equal to Bb' , the difference in elevation between C and B . Connect its extremity with D and the angle bDd will be the angle sought, the inclination of the fault plane to the horizontal.

Unless the field measurements have been made with exceptional accuracy the error in the above solution will come well within the limit of error of observation.

This method is of course applicable in the determination of strike and dip of any inclined plane in which the relative position of three points is known. Thus it will be found useful in determining the strike and dip of a bed which is intersected by drill holes, or which, from the nature of its exposures, does not admit of direct measurement.

Angle of intersection with oblique vertical plane. — It frequently becomes necessary to determine the angle of intersection of a fault (or other inclined plane) with a vertical plane oblique to the strike of the fault.

The trigonometric solution may be used when tables of natural or logarithmic functions are at hand. Let m be the angle of dip of the inclined plane and n the angle between the strike of the inclined plane and the vertical plane. To find x , the angle which the line of intersection of the two planes makes with the horizontal

$$\tan x = \tan m \sin n.$$

The problem may be solved by construction as follows: Let AK , Fig. 105, be the azimuth of the vertical plane; draw AL so that the angle $KAL = n =$ the angle made by the strike of the inclined plane and the azimuth of the vertical plane.

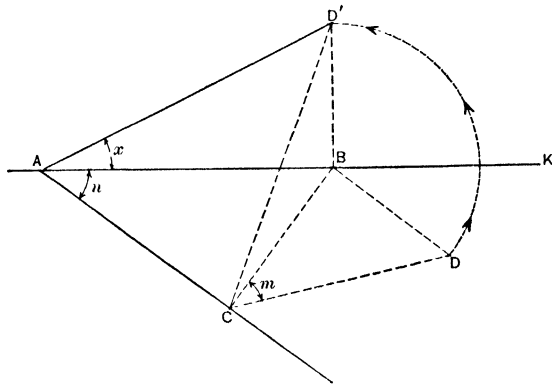

FIG. 105. — Diagram illustrating determination of angle of intersection of fault plane with vertical plane oblique to strike of fault.

Take any point C on AL and erect a perpendicular CB . With CB as a base construct a right triangle with the angle $BCD = m =$ the angle of dip of the inclined plane. Draw $BD' = BD$ and at right angles to AB . Connect A and D' . The angle $BAD' = x$ will be the angle sought.

Per cent and angular inclination. — The attitude of slightly inclined bedding planes or other surfaces is generally expressed by engineers in percentages, and it is therefore frequently necessary to convert such percentages into their equivalent angles. It is also at times desired to convert angular inclination into the equivalent percentage. This conversion involves the use of a table of natural tangents more extended than that given on page 165, and the table of equivalents is therefore inserted below. The angles are given only to the nearest five minutes, which is sufficient for geologic purposes, and is nearer than the angles can be plotted with an ordinary protractor.

CONVERSION OF PER CENT GRADE TO ANGULAR INCLINATION

Per cent grade	Angular inclination		Per cent grade	Angular inclination		Per cent grade	Angular inclination	
	Deg.	Min.		Deg.	Min.		Deg.	Min.
1		35	7.00	4		13.00	7	25
1.50		52	7.50	4	15	14.00	8	
1.75	1		8.00	4	35	15.00	8	30
2.00	1	10	8.50	4	50	15.85	9	
2.50	1	25	8.75	5		16.00	9	5
3.00	1	45	9.00	5	10	17.00	9	40
3.50	2		9.50	5	25	17.65	10	
4.00	2	15	10.00	5	45	18.00	10	15
4.50	2	35	10.50	6		19.00	10	45
5.00	2	50	11.00	6	15	19.45	11	
5.25	3		11.50	6	35	20.00	11	20
5.50	3	10	12.00	6	50	21.00	11	50
6.00	3	25	12.25	7		21.35	12	
6.50	3	45	12.50	7	10

Form of Outcrop

The line drawn on the map to represent a formation boundary is the trace of two intersecting surfaces — the land surface and the surface separating the overlying and underlying formations. Since both are irregularly warped surfaces their intersection will be a complicated trace, and unless careful consideration is given to the geometric relations involved, the location of the line is apt to be inconsistent with the geologic structure. If it were possible or practicable to actually trace on the ground all lines which will be shown on the map, their location would be a simple matter, but the nature of exposures generally prevents such continuous tracing, and even where this is not the case the expenditure involved would be excessive and prohibitory. In practice, therefore, the location is determined of as many points as possible under the limitations of time and expense, and the line is drawn upon the map between these determined points so as to be consistent with the form of the two intersecting surfaces.

It is assumed that the land surface will be accurately represented by contours; the form of a line marking the intersection of a land surface so represented and any geological surface, as a bedding plane, fault plane, unconformity, eruptive contact, etc., may be considered under three cases: (1) in which the geologic plane is approximately horizontal; (2) in which it is approximately vertical, and (3) in which its inclination varies anywhere between 0° and 90°.

(1) It is evident that the intersection of a horizontal geologic plane with any land surface will coincide with an interpolated land surface contour, since by definition contours are simply the traces of intersections of the land surface with equidistant imaginary horizontal planes.

A boundary between horizontal formations will therefore be drawn between located points in such a manner as not to cross a contour line. The drawing of such lines, particularly if a large number of points are located, is a rigid check on the accuracy of the contouring and will generally necessitate more or less revision of the latter.

(2) It is equally evident that the intersection of a vertical geologic plane with a land surface is not influenced by the inequalities of the latter, and therefore has no

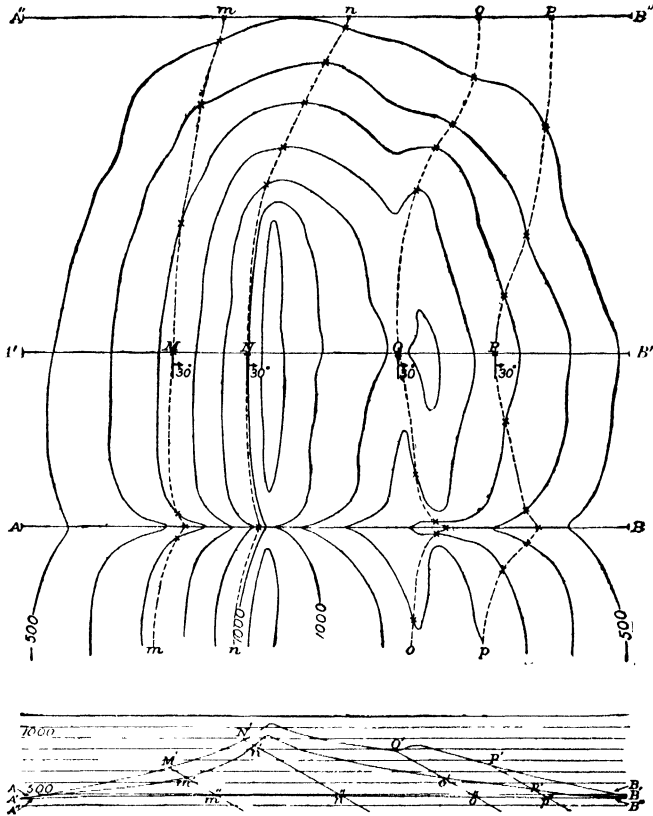

FIG. 106. — Diagram illustrating form of outcrop. (After Hayes.)

definite relation to the surface contours. Hence a boundary between vertical formations will be drawn between located points by straight lines or confluent curves, regardless of contours.

(3) Between the two extremes, horizontal and vertical dips, an infinite variety of relations occur between the intersection and the contour lines. Two general cases may be discriminated; (a) where the geologic plane dips into a sloping land surface, and (b) where it dips with the land surface. The two cases are illustrated by the formation boundaries; (a) on the face, and (b) on the back of a monoclinical ridge, as shown in Fig. 106, in which the contour interval is 100 feet and the distance from A to B is one mile.

Let it be assumed that a section has been made across this ridge from A to B and the points M , N , O , and P on the formation boundaries accurately located; also that the strike and dip of the beds have been determined. The problem is to determine the location of the boundaries on the map with reference to the contours when continued on either side of the section.

Points on these lines may be determined in the following manner. Construct the profile AB to scale. The distance between the horizontal ruled lines is equal to the contour interval, 100 feet, and the profile is constructed by projecting the points of intersection of the profile AB and the various contours. Project upon this profile the points M , N , O , and P , and draw the lines $M'm'$, $N'n'$, etc., the angles corresponding to the determined dip of the beds. In the same manner construct the profiles $A'B'$, and $A''B''$. The point m' , at which the dip line $M'm'$ intersects the profile $A'B'$ is projected upon the section line $A'B'$, and fixes the point on the map at which the boundary crosses the bottom of the ravine. Between M' and m' the dip line crosses the horizontal ruled line corresponding to the 700-foot contour. This point projected upon the map gives the several points at which the boundary mn crosses this contour, and in a similar manner the points at which it crosses the 600- and 500-foot contours are obtained. Connecting the points thus located on the map the correct position of the boundary is fixed.

The dip line $N'n'$ does not cross a horizontal line between N' and n' , hence the boundary nn remains between the 900- and 1000-foot contours in crossing the ravine $A'B'$.

In the same way points are located on oo and pp . The dip line $O'o'$ crosses the two horizontal lines between O' and o' , hence the boundary crosses two contours between the point O and the bottom of the ravine in which the section $A'B'$ is located. The points at which it crosses the contours are determined as above, by projecting the intersections of the dip line and the horizontal ruled lines upon the corresponding contours.

From an inspection of the diagram it will be observed (1) that wherever the boundary lines cross surface depressions they bend in the direction of the dip; (2) that where the bedding planes dip *into* the slope (nm and nn , case (a) above), the boundary lines bend in the same direction as the contours, but less acutely; (3) that where the bedding planes dip *with* the slope (oo and pp , case (b) above), the boundary lines bend in the opposite direction from the contours, and the deviation from a straight line increases as the dip decreases, (4) that the width of outcrop of a formation which occurs on a slope is less than the outcrop of the same formation on a level surface if the beds dip into the slope, and greater if they dip with the slope."

ROCK CLEAVAGE

Definition. — The term *rock cleavage* as used in its broadest sense, and only in a structural one, includes the property which many rocks possess of splitting along parallel surfaces in certain directions more readily than in others.

Original and secondary. — We can then recognize two types of rock cleavage, viz., *original* and *secondary*. The former would include such structures as bedding and lamination in sedimentary rocks, flow structure in lavas, etc.; in other words, all original planes of low cohesion along which the rock may split. The latter includes parallel structures which have been induced in rocks by metamorphism subse-

quent to their formation, and includes such structures as true cleavage, slatiness, schistosity, foliation, fissility, etc. Rock cleavage is applied by most geologists to secondary structures only.

Secondary cleavage is divided into (1) *fracture cleavage* and (2) *flow cleavage*.

Fracture cleavage. — Fracture cleavage¹ is the structure developed when a rock under stress breaks along closely-spaced, incipient, parallel joints, and the term *fissility* applies to such partings. It is closely related to joint structure.

In many quarries the rock appears massive, but when struck with a hammer, the stone breaks along definite planes. Such structural weaknesses are known to the quarryman as *blind joints*. They are common in the older crystalline rocks, constitute lines of weakness, and prevent the use of the rock for dimension blocks.

Fracture cleavage is independent of parallel dimensional arrangement of the minerals, and there may be two or more intersecting sets of planes. It is frequently related to flow cleavage in occurrence and origin, and one may grade into the other.

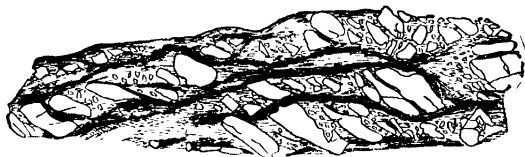

FIG. 107. — Sliced feldspars in micaceous and chloritic schist from southern Appalachians. Shows granulation of feldspars due to flow cleavage. (After Leith, Structural Geology.)

Flow cleavage. — In flow cleavage the capacity of the rocks to part along parallel surfaces, not necessarily planes, is dependent on parallel dimensional arrangement of the mineral constituents. It is the “*cleavage proper*,” and includes the cleavage of most writers. *Slatiness* or *slaty cleavage* of slates, *schistosity* or *foliation* of schists, and in part *banding* or *gneissic structure* of gneisses are all phases of it.

Slaty cleavage. — The development of flow cleavage in the group of fine-grained metamorphic argillaceous rocks known as slates is called *slatiness* or *slaty cleavage*. It is a secondary structure developed independently of the original bedding planes,

¹ Other names for fracture cleavage are close-joint cleavage, false cleavage, strain-slip cleavage, slip cleavage, rift, etc.

and the two structures (slatiness and bedding) may or may not coincide. Cleavage is best developed in the fine-grained, homogeneous clay rocks like slate. It is more or less perfect in slates, separating them into very thin layers or laminae with relatively smooth surfaces, thus adapting them to the various commercial uses. (See further under Slates, p. 139, and in Chapter XI.)

Schistosity. — The foliation or cleavage in schists is referred to as *schistosity*, a characteristic feature of this group of rocks as described in Chapter II. In schists the mineral particles are larger than in slates, and the rocks cleave into layers (schistose structure) with more or less rough or wavy surfaces, the degree of smoothness being conditioned in large measure by the abundance of good cleavage-producing minerals, such as mica, hornblende, etc. Schistosity, a similar structure to slatiness, indicates more severe metamorphism than slatiness, although there occur all gradations between schists and slates.

Gneissic (gneissoid) structure. — All gneisses, regardless of origin, whether igneous or sedimentary, show a banded or gneissic structure, but they may or may not show parallel dimensional arrangement of the mineral particles necessary for rock cleavage or schistosity. Parallel or banded structure is original in some gneisses and has not developed subsequently from secondary causes. (See further under Gneiss, Chapter II, and under Building Stone, Chapter XI.)

ORIGIN OF FOLDS, FAULTS, JOINTS AND CLEAVAGE

Introduction. — When subjected to stresses of sufficient intensity, rocks are deformed either by fracturing or by flowing. Among the chief factors involved in the deformation are the character of the rocks, presence of moisture, and depth of burial, because pressure increases with depth. Based upon the character of the deformation of rocks when subjected to stresses, Van Hise has divided the outer crust of the earth into three zones:

I. An upper zone of fracture in which the rocks are deformed mainly by fracture. The ruptures are those of jointing, faulting, differential movement between the layers, fissility, and brecciation. The maximum thickness of this zone is placed by Van Hise at from 10,000 to 12,000 meters, but these limits have recently been extended by Adams to a depth of 11 miles or 17,600 meters for granite.¹

II. A middle zone of combined rock fracture and flowage, in which the pressure is only sufficiently great to cause some rocks to fracture, but enough to make others flow. This zone is estimated to have a thickness of possibly as much as 5000 meters.

III. A lower zone of flowage in which deformation is by granulation or recrystallization, no openings being produced, or at least none ex-

¹ Jour. Geol., XX, p. 97, 1912.

cept those of microscopic size because larger ones would be closed by pressure. Rock flowage results in a parallel dimensional arrangement of the rock constituents producing foliation, which is variously designated as cleavage (flow or true cleavage), banded structure, etc.

Gradational structures occur between fracture and flow. Folds, for example, may be developed by either flowage or fracture, or by both combined.

With this explanation we may consider a little further the origin of some of the structures discussed in the preceding pages.

Cause of folds.¹ — Folds are caused by diastrophism in sedimentary and igneous rocks. They have resulted, in most cases, from fracture and flowage. However, "not all folding requires fracture or flowage, nor does all fracture or flowage involve folding" (Leith). The forces which cause folding are usually orogenic disturbances and, on the whole, are compressional, although they may be partly or entirely tensional within the fold itself. Lateral compression acts with tangential thrust movements.

While not a matter of general agreement, the ultimate origin of the orogenic forces has probably been caused by shrinkage in volume of the earth's rock mass. Shrinkage of the earth, one of the principal causes of deformation, is probably "due to heat transfer from the interior outward," whether based on the nebular or planetesimal conception of earth genesis.

When folding takes place in the zone of fracture it is probably caused by the rocks slipping along planes of jointing, faulting, or cleavage. But when it occurs in the zone of flowage the rocks become practically plastic and the folding may be due either to the mineral particles gliding one upon the other or actually changing their individual shapes, or in part dissolving in points of higher pressure and recrystallizing at points of less pressure. Factors affecting the result are the degree of rigidity of the beds, rate of application and duration of the pressure, and depth below the surface.

All folds result from yielding to pressure, and field studies show that rocks have varying degrees of competence, so that in areas of folding the weaker beds have been controlled by that of the stronger or more competent beds. In a series of interbedded quartzite and shale the folding of the rigid, competent beds of quartzite might very well show the characteristics of the zone of fracture, while the associated weaker and incompetent beds of shale would, from development of cleavage, characterize the zone of flow. In such a series the rigid, competent beds of quartz-

¹ Leith, C. K., *Structural Geology*, 1923 (revised).

ite sometimes exhibit little or no folding, while the weaker, incompetent beds of shale are folded, the quartzite being in the zone of fracture and the shale in the zone of flow, as indicated by the development of cleavage in the latter. This principle is well exemplified in parts of the Valley region of Virginia, in which beds of limestone have been deformed (folded) by fracturing, while the associated beds of shale have been deformed by flow.

Cause of joints. — Joints are limited to the zone of fracture, and may occur in rocks of both disturbed and undisturbed regions, but while their horizontal distribution may be great, they are limited vertically by the depth of the zone of fracture, though some believe they may not extend to the full depth of that zone.

Among the causes to which joints are referred, are tension, compression, torsion, shearing, earthquakes, etc., but a discussion of all these is not contemplated here. Joints are caused by tension or by compression stresses, or by a combination of these, as in torsion, etc.

Two important classes of joints are those formed by stretching of the rocks or *tension joints*, and those formed by pressure or *compression joints*. For certain lines of structural geologic work, their discrimination is of importance.

Tension joints, whose formation indicates extension of surface. They may include: (1) Open joints, not modified by solution or weathering; (2) joints developed along crests of anticlines; (3) those formed during cooling of igneous rocks, a special case being that of the prismatic jointing in basalt; and (4) joints developed in drying and shrinkage of sediments, as for example mud cracks, etc.

Compression joints, whose formation indicates compression. They are more difficult to recognize. They may include: (1) Some joints showing slip surfaces; (2) joints which pass into overthrust faults or folds; (3) certain ones observed on limbs of folds, as shown by the way in which they follow directions of compressive shear; and (4) horizontal sheeted structure developed in granite, due probably in part at least to compression, etc.

Cause of cleavage. — The term cleavage has been defined on page 199, and it was stated there that secondary cleavage was of two kinds, fracture and flow cleavage. Both, however, are due to compressive forces, but fracture cleavage, including fissility, is probably more characteristic of the harder rocks, and slaty cleavage of the softer ones. Composition, and fineness of division of the mineral particles also affect the result.

Cause of fracture cleavage. — Fracture cleavage is developed in the zone of fracture, and is independent of the parallel dimensional arrangement of the minerals, but such parallel arrangement as is sometimes seen in chlorite and mica, may result from rubbing on fracture planes. If at the same time the cleavage planes are closely spaced it

may be difficult to distinguish from flow cleavage. Normally, fracture cleavage planes are more widely spaced than flow cleavage planes (described below), and moreover, may be developed in two or more intersecting sets.

Cause of flow cleavage.—Flow cleavage means parallel dimensional arrangement of the mineral particles, and results from differential pressure in the zone of flow, causing the rock to deform by flowage and not by fracture; it therefore involves a combination of physical and chemical changes. The processes which bring about the parallel arrangement of the mineral particles are: (1) *Crystallization and recrystallization* resulting in the flattening of old minerals and development of new ones in the planes of easiest relief, and (2) *rotation and granulation of the original minerals*, such as quartz and feldspar. Gliding along definite planes of some minerals, especially calcite, will also result in flattening of the mineral particles, and consequently in parallel arrangement.

STRUCTURES DUE TO EROSION

Under this head are discussed several structures, (1) unconformity and overlap, and (2) inliers and outliers, which owe their origin in most cases to erosion, although they may be the result in part at times of other causes, such as faulting and folding.

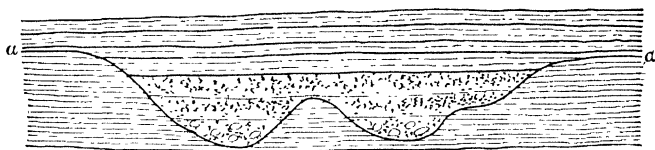

FIG. 108. — Section showing erosion unconformity *aa*, with concordant dips.

Unconformity and Overlap

Unconformity.—Strata that have been deposited in orderly sequence, so as to form a continuous succession of beds, and when disturbed have been similarly affected by movements, are said to be *conformable*, and the structure is known as *conformity* (Fig. 71). In such a succession of beds, each one has been regularly laid down upon the next preceding one.

In many places, however, this orderly succession of beds has been interrupted by cessation in deposition for a period of time, represented by a hiatus or break in the geological record, and marked by an erosion interval of more or less magnitude. There has been a loss of a part of the geological record. The formations are discordant and are said to be *unconformable*, the structure being called *unconformity* (Figs. 108 and 109).

Unconformities are of great importance in the interpretation of geological history. Thus in Fig. 109, the structure indicates that the conformable series of lower inclined beds was first deposited under water and afterwards raised, tilted, or folded into a land surface. After elevation above water into a land surface, the beds were subjected to a long period of erosion whereby they were reduced to a nearly common level, and again depressed beneath the water, when the second set of beds was deposited on them, and the whole finally elevated to form a land surface. The two sets of beds are discordant as shown in (1) dissimilarity of dip, (2) an erosion interval and therefore a hiatus or time break, and (3) in a coarse conglomerate bed forming the basal member of the upper conformable series of horizontal beds.

Discordance of dip is not to be interpreted in every case as indicating unconformity, for it results from various causes, such as faulting, folding, etc. Moreover, unconformities occur in horizontal beds in which the two series of bedded rocks exhibit similarity of dip, as shown in Fig. 108.

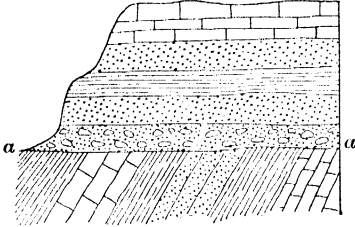

Fig. 109.—Section showing unconformity *aa*, with discordant dips.

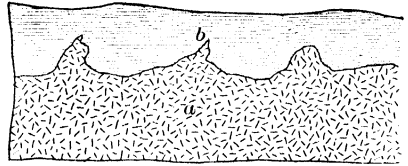

Fig. 110.—Igneous unconformity between (a) granite, and (b) sedimentary rocks.



Fig. 111.—Igneous unconformity, between extrusive lava sheets. Upper surface of sheet (a) marked by scoria, amygdules and gas cavities; upper surface of sheet (b) shows amygdaloidal texture.

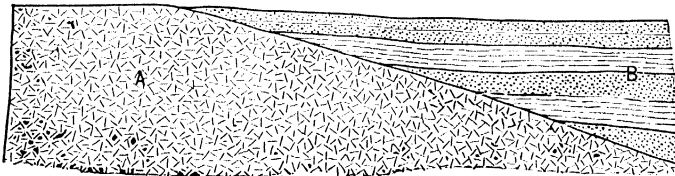

Fig. 112.—Section along contact of Piedmont crystalline rocks (A), and Coastal Plain sediments (B), showing overlap.

Unconformities are not limited to groups of stratified rocks, but are sometimes observed between stratified and igneous rocks (Fig. 110), and between stratified and metamorphic rocks.¹ The line of contact between two unconformable series of beds is sometimes a line of weakness and decay that causes trouble in underground work.

Overlap.—Overlap defines the relation between members of a conformable series of rocks, and is dependent on the existence of an unconformity. In a con-

¹ For a detailed discussion of the criteria of unconformity see Van Hise, U. S. Geol. Survey, 16th Ann. Rept., p. 1, 1896.

formable series overlap is shown when an upper bed extends beyond the limits of the one or ones below, so that the edges of the lower bed or beds are concealed. The structure indicates subsidence accompanied by deposition, and is well illustrated in the eastern United States in the overlapping of the beds of the Coastal Plain formations onto the older crystalline rocks of the Piedmont region (Fig. 112).

Overlap is of much practical importance in mining operations as well as in questions of water supply, and failure to recognize this structure has led in some places to disappointment and loss. Well-known cases of this kind, especially those relating to the exploitation of coal beds, are reported both from this country and abroad.

Inliers and Outliers

Inliers. — An inlier represents outcrops of rocks that are surrounded on all sides by geologically younger rocks. It is usually the result of erosion, and the structure is often observed in valleys or similar depressions. Thus in North Carolina and other southern states, isolated outcrops of granite belonging to the Piedmont crystal-

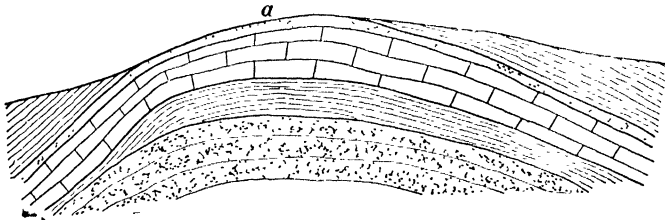

FIG. 113. — Section showing an inlier (*a*) formed at summit of an anticline by erosion.

line rocks are observed some distance east of the fall-line, chiefly along or near stream courses, lying well within the limits of the Coastal Plain, and surrounded by the younger rocks of this province.

Sometimes an inlier is observed on the crest of an eroded anticline (Fig. 113), and again as the result of faulting, as shown in Fig. 114.

Outliers. — An outlier is the converse of an inlier, and as the name implies represents an isolated portion of rock separated from the main mass and surrounded

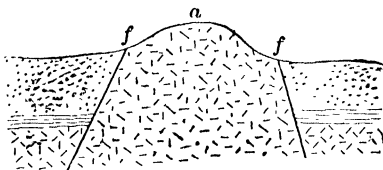

FIG. 114. — Section showing an inlier (*a*) formed by faulting. *f*, faults.

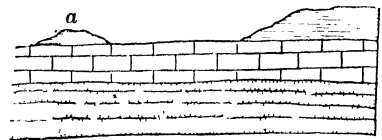

FIG. 115. — Section of outlier (*a*) formed by erosion.

by rocks that are geologically older (Figs. 115 and 116). Outliers are usually the result of denudation and are of frequent occurrence in areas of strong erosion. They frequently occur capping hills and ridges, and may owe their existence to either the resistant character of the rock composing them or to their geological

structure, or both. They may be separated from the parent mass by a long or short distance.

Outliers may sometimes be the direct result of faulting, as shown in Fig. 117. According to their mode of formation two principal classes of outliers may be recognized, (1) *erosion outliers*, the most common; and (2) *faulted outliers*.

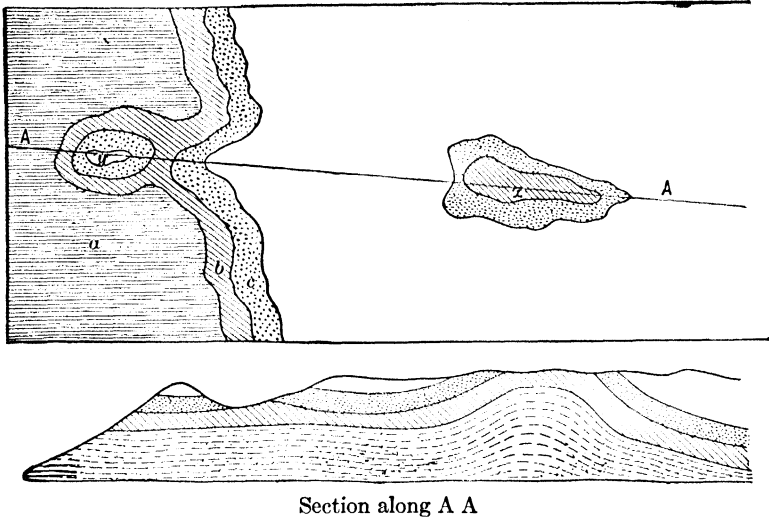

FIG. 116. — Outliers formed by erosion.

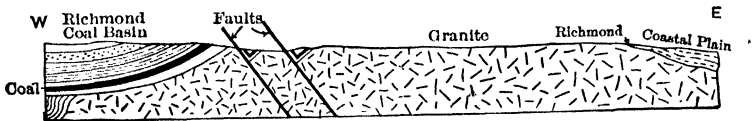

FIG. 117. — Outliers formed by faulting.

CONCRETIONS

Form and occurrence. — Concretions or nodules are bodies of foreign material, found mostly in sedimentary rocks, and in most cases probably of later origin than the material containing them. They are often nearly perfect spheres, or again flattish with elliptical outline, and in still other cases assume grotesque forms, causing many people to mistake them for fossilized animal remains. They often contain a nucleus which may be a fossil, piece of rock or other object. Their size varies from a fraction of an inch in diameter to several feet, but some contain a central cavity, and one form which is divided by radial cracks, filled with mineral

matter, is known as a *septarium*. Concretions are usually harder and more resistant than the inclosing rock, and so they often stand out in more or less strong relief on the weathered surface (Plate XIII, Fig. 2).

Origin. — While it is known that most concretions are probably of later age than the inclosing rock, still their exact mode of formation is not always clearly understood, although many of them represent a segregation of foreign matter around some nucleus.

Material forming concretions. — The materials forming concretions, and the kinds of rock they often occur in are: (1) Flint or chert in limestone (Plate XIII, Fig. 2) and chalk; (2) pyrite, in coal, shale and slate; (3) iron carbonate in clays (Plate XXVII, Fig. 1) and shales; (4) clay and lime carbonate in clays (Plate XXVII, Fig. 2); (5) cemented sand grains in sands; (6) gypsum in clays and shales; and (7) barite in some sands and clays; etc.

Practical considerations. — Concretions are rarely of economic value, but on the contrary are usually a source of trouble.

Iron carbonate concretions, when found in clays or shales, are sometimes used as a source of iron ore, if sufficiently abundant, and not too high in impurities.

Flint nodules occurring in some of the European chalk deposits, which have become rounded when washed out of the cliffs and rolled by wave action, are used in ball mills.

Flint concretions are undesirable in limestone that is to be used for structural work (Chapter XI) or in cement manufacture (Chapter XII). They interfere with the dressing and grinding of the stone.

In clays or shales which are to be used for brick or sewer-pipe manufacture, concretions will, unless removed or crushed, be the cause of various troubles, such as cracking, pimples, fused spots, etc. Gypsum nodules found in shales are never a commercial source of that material. Pyrite nodules in coal lower its market value, because they raise its sulphur content, while in slate they injure its durability and appearance.

METAMORPHISM OF ROCKS

Introduction. — Broadly speaking, metamorphism applies to any change in the constitution of any kind of rock. Under a given set of conditions, minerals tend to form in rocks under those conditions which remain permanent, that is, they tend to adapt themselves to their new environment. The adjustment, however, of a rock to new conditions takes place slowly, so that it may remain essentially under the same conditions for a long period of time.

The conditions under which rocks alter are numerous and varied, and may be those of ordinary pressure and temperature at or near the surface, or they may be those of very high temperature and pressure which exist at some depth below the surface. A rock mass may be subjected alternately to each of these conditions. Most changes in rocks take place under conditions that cannot be directly observed, but can only be inferred, such as all changes below a mile in depth. Rocks may undergo change near the surface and later, as the result of burial, be changed at greater depth; or they may undergo changes at great depth and subsequently be brought near the surface by erosion of the overlying rocks and there be changed again. Such modification means that one set of changes in a rock may be superimposed on another.

Definition. — In view of the above statements then metamorphism might be defined as any change in any rock, regardless of origin, and may be the result of chemical or physical agencies, or both. If such changes take place at or near the surface we call them *weathering*, but if they go on at some depth and involve densification, recrystallization, or change in mineral composition we call them *alteration* or metamorphism proper. The subject of *weathering* is treated in Chapter IV, so that the discussion here is restricted to the deep-seated changes in rocks — *alteration* — or *metamorphism proper*.

There are many degrees of metamorphism and they vary greatly in intensity. In some cases the rock has been so slightly changed that the original characters are still evident, whether of sedimentary or igneous origin, but in others the metamorphism has been so complete as to obscure all trace of the original character of the rock, so that it becomes conjectural as to what its original nature was. Such metamorphism in a rock may result in partial or complete change of texture, structure, or mineral composition. Thus, a sandstone may be changed to a quartzite, in which only a change of texture has been involved, while that of structure and mineral composition remain unaffected. It frequently happens, however, that a rock, after metamorphism, especially under conditions of deep burial, shows no change in chemical composition, but a profound one as to mineral composition and structure. Thus, a pyroxene-bearing rock, such as dolerite, might be transformed into hornblende schist, which would be both a structural and mineralogical change. Igneous rocks, such as granite, diorite, gabbro, etc., may be rendered gneissic without essential change either in chemical or mineral composition. A change of structure (foliation), however, in igneous rocks may not be the only one involved.



PLATE XXVII, FIG. 1. — Siderite concretions in clay, Anne Arundel County, Md. (Md. Geol. Survey, IV).



FIG. 2. — Lime carbonate concretions at Hopyard, Rappahannock River, Va.
(209)

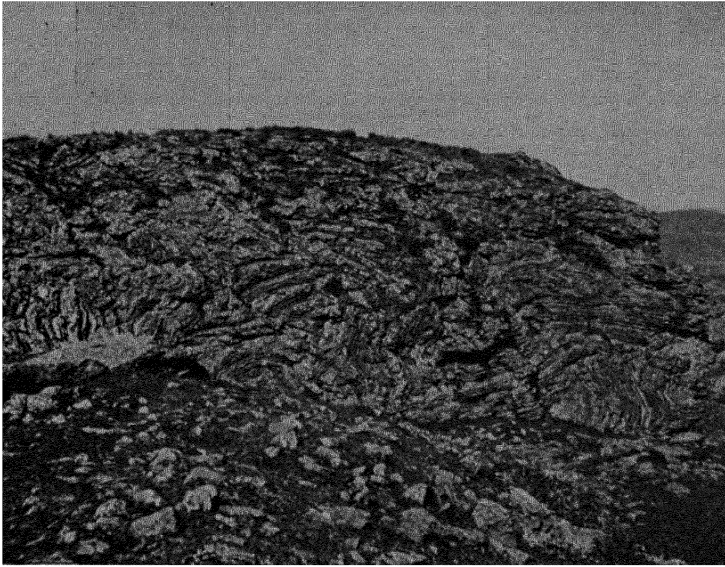

PLATE XXVIII, FIG. 1. — Much contorted and metamorphosed argillaceous and calcareous beds, filled with contact silicates, due to granite intrusion, Cirque d' Arbison, Pyrenees. (H. Ries, photo.)

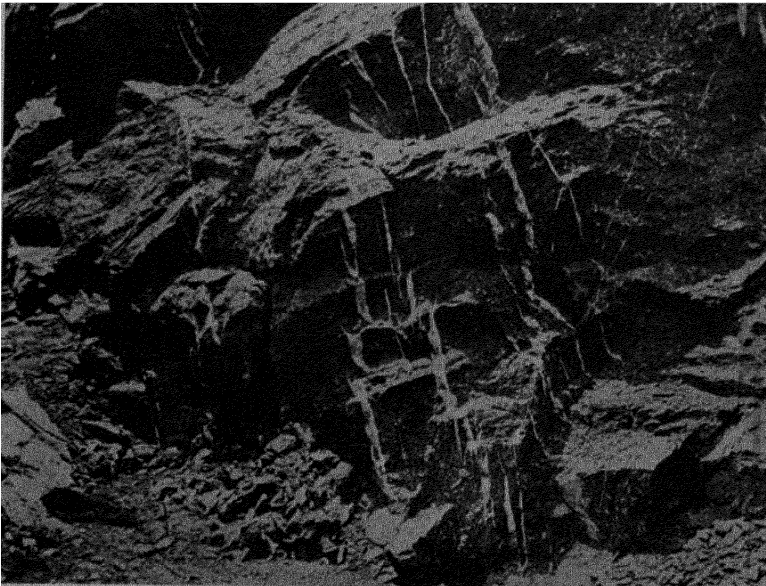

FIG. 2. — Fractures in limestone produced by folding and filled with calcite, Christiansburg, Va. (H. Ries, photo.)

Agents of metamorphism. — The principal agents of metamorphism are (1) mechanical movements of the earth's crust and pressure; (2) liquids and gases; and (3) heat. All of these are considered necessary to the complete metamorphism of a rock, but not necessarily to the same degree, since one of them may be predominant in producing the change in one case, and some other in another. We may consider these chief agencies of metamorphism separately below, in the order named.

Mechanical movements and pressure. — Downward pressure alone exerts little or no metamorphic effect because many sediments which have been deeply buried and subsequently uncovered by erosion show little evident change except consolidation. Earth movements, on the other hand, are very effective in producing changes in rock masses, as shown in the production of folds and the accompanying structures, such as joints, faults, and of foliation in some or all of the involved rocks. Shearing stresses are set up as a result of pressure, which result in differential movement of the rock constituents, as shown in the broken fragments that are often flattened and elongated in the direction of shear. The degree of change will depend upon the intensity of compression and the depth at which it operates. Earth movements when accompanied by heat and water effect important chemical changes, and frequently the production of new minerals.

Solutions (liquids and gases). — Of these water is the most abundant and therefore the most important. Whatever its source (whether meteoric or magmatic, Chapter XVII) may be, water is an effective agent of metamorphism, the rôle which it plays in producing rock changes being a chemical one, and it becomes more effective when accompanied by heat and pressure.

Water acts as a solvent upon nearly all rock-forming minerals, slowly transferring mineral matter from one point to another, which promotes recrystallization. It is partly taken up into the molecules of new compounds (minerals), such as staurolite, epidote, mica, etc., and it is necessary to their formation. It is further aided by the substances which it may carry in solution, such as the emanations (fluorine, boric acid, etc.) given off from intrusive magmas, and which can only account for the formation of such minerals as tourmaline, vesuvianite, etc.

Heat. — The heat involved in metamorphism may come from several different sources: (1) Interior of the earth, which increases with depth, (2) developed from earth movements, and (3) from the intrusion of molten magmas. Whatever the source, heat is a most potent agent of metamorphism, as shown by the pre-eminence of contact or local metamorphism discussed on page 214. Heat greatly augments the solvent action of solutions, and it promotes the formation of new chemical compounds.

Zones of metamorphism. — As already explained, the processes of change in rocks near the surface are quite different from those taking place at depth. Consequently, depth is regarded as an important geological factor in determining the character of the alteration. Based on depth we recognize two zones, viz.: (1) An upper one in which mineral compounds are broken down (*katamorphic zone*), and a lower one in which simple compounds are built over into more complex ones (*anamorphic zone*). The upper part of the first zone, which extends to the groundwater level (see Chapter IV) is the *belt of weathering*, and the lower part has been called by Van Hise the *belt of cementation*.

Katamorphic zone. — The limits of the zone of katamorphism are essentially those of the zone of fracture (p. 192), and extend from the surface to a depth ordinarily of 10,000 to 12,000 meters for the strongest rocks under quiescent conditions. The alterations that take place in the two belts (weathering and cementation) of this zone are strongly contrasted. The characteristic reactions of the belt of weathering are discussed in Chapter IV, and it suffices here to state in summary that it is especially characterized by solution, decrease of volume, and softening of the materials; the processes are destructive, resulting in degeneration. On the other hand, the belt of cementation is especially characterized by deposition, increase of volume, and induration of the materials; the processes are constructive and result in physical coherence. The materials dissolved from the belt of weathering are transferred in solution to the lower belt of cementation and there deposited. It must not be misunderstood that solution may and does go forward in the belt of cementation, but that solution and deposition are more nearly balanced in this belt.

Anamorphic zone. — The zone of anamorphism corresponds to the zone of flowage, in which there is great pressure in all directions. It is a zone of *reconstruction*, and is especially characterized by silication involving decarbonation, dehydration, and deoxidation; the minerals formed are numerous, of high specific gravity, and probably of complex structure. The reactions take place with decrease of volume, and usually little absorption of heat.

Kinds of metamorphism. — The various kinds of metamorphism that have been recognized, based on the dominant force, agent, or process involved in the alteration of a particular kind of rock are: (1) Thermal-metamorphism, which refers to heat; (2) hydro-metamorphism, which refers to the presence of water; (3) chemical metamorphism, which refers to the action of chemical forces; (4) static and pressure metamorphism, which refer to quiescent conditions; (5) dynamo-metamorphism, which refers to conditions of motion; (6) regional metamorphism, which refers to the extent of alteration; and (7) contact or local metamorphism, which refers to the proximity of an igneous rock.

It is probable that no one of these agents acting alone is of great importance, but that they are all involved, though in varying degrees in different cases. For convenience of discussion, we may divide metamorphism into: (1) *Contact or local metamorphism*, and (2) *general*



PLATE XXIX, FIG. 1. — Granite quarry, near Woodstock, Md., showing horizontal joints. (T. L. Watson, photo.)

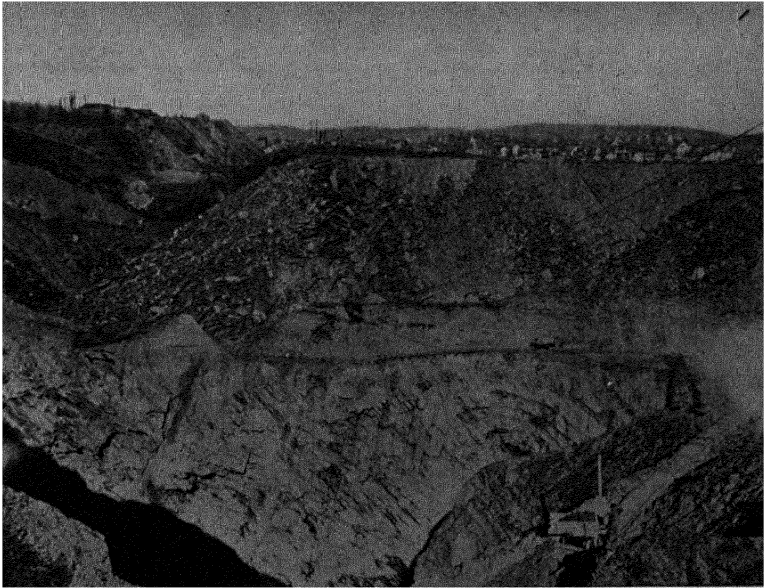

FIG. 2. — Slate quarry, Penrhyn, Pa., showing folded beds and cleavage. (H. Ries, photo.)

or *regional metamorphism*. These two kinds of metamorphism are generally recognized by most geologists, and especially the economic geologist, as having an important bearing on the formation of ore deposits.

Contact or Local Metamorphism

Introduction. — By contact metamorphism is meant the changes produced by intruding igneous masses in contact with other rocks which they invade. The invaded rock may be either sedimentary, igneous, or metamorphic, but the most pronounced changes are shown

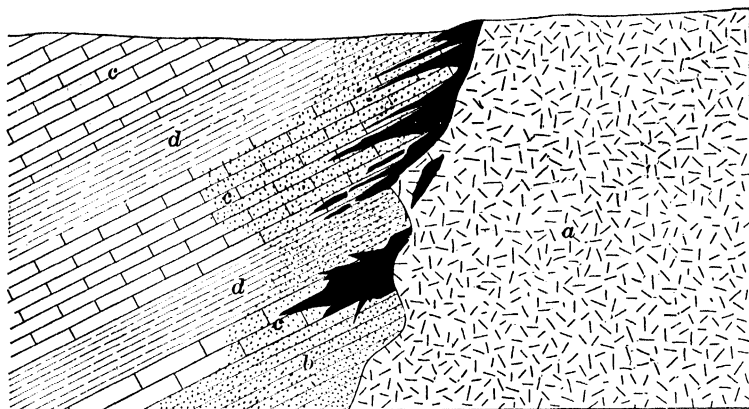

FIG. 118. — Section through a contact metamorphic zone; showing (a) intrusive rock; (b) quartzite; (c) limestone; (d) shale. Contact metamorphic zone shown in stippled area, including ore in black.

in sedimentary rocks, especially limestones. This is because the siliceous crystalline character and dense texture of the igneous and metamorphic rocks make them resist alteration.

Igneous rocks of volcanic character rarely cause pronounced metamorphism, save that of hardening and baking of the rock surface over which they flow, and even here the changes are best developed in sedimentary rocks.

The changes which result from contact metamorphism may affect both the intrusive rock and the intruded ones at or near their contact. Those developed in the intrusive body may be termed *endomorphie*, and those affecting the intruded rocks are called *exomorphie*.

Endomorphic changes. — The commonest endomorphic effects observed are: (1) Change in mineral composition, and (2) change in texture, the latter being the more common. The border changes in

chemical composition may be due to magmatic differentiation (p. 69), or to the presence of mineralizers (p. 66), which tend to be squeezed out toward the margin as the interior solidifies, and collect there. As a result we sometimes find tourmaline, as around the borders of granite masses, or the development of pegmatite. The textural change may be shown by finer grain due to chilling of the outer portion of the intrusive mass, or in other cases a porphyritic texture is developed.

Exomorphic changes. — These depend on: (1) Character of country or invaded rock; (2) size of intrusive; (3) character of vapors expelled by the intrusive during solidification; and (4) structural features and position of beds of country rock. The area in which the exomorphic changes occur is known as the *contact zone*, and is of variable width, being one or even two miles in some cases, but usually much smaller as well as irregular. Shales and slates are baked to a hard siliceous rock called "hornfels," while limestones are converted into marble. New minerals are developed, and these are especially abundant in limestone, where they are of both metallic and non-metallic character. Indeed the former are often in sufficient abundance to form ore-deposits (Chapter XVII).

One former theory was, that the minerals developed in the contact zone, represented re-arrangement of the materials already present in the country rock, but since the latter in its original form may be quite pure (some limestones), it seems clear that many of the contact zone minerals are made up of materials given off by the intrusive, a view now quite generally held. Characteristic contact silicates formed in limestone include garnet, epidote, wollastonite, and pyroxene. Garnet sometimes makes up the entire mass of the rock.

Contact-metamorphic effects on different kinds of rocks. — As previously remarked, the intensity and extent of contact metamorphism depends in part on the size and character of the intrusive rock, but, other things being equal, it is usually most pronounced in sedimentary rocks, such as limestones, clay shales, and slates, and to a less extent in sandstones. The effect produced on each of these is briefly stated below.

Limestones are especially susceptible to alteration along contacts with igneous intrusions. The pure limestones are changed into crystalline marbles through crystallization. The impure varieties containing such impurities as siliceous and argillaceous materials usually exhibit the most marked effects in development of contact metamorphic minerals, such as garnet, epidote, diopside, tremolite, vesuvianite, tourmaline, etc., among the silicate forms, and in many cases ore minerals, — a mixture of sulphides and oxides, — which latter are often present in sufficient quantity to yield valuable ore-deposits of the contact metamorphic type (see Chapter on Ore-Deposits). The limestone may be entirely changed into the lime-bearing silicate minerals, or it may be changed into a highly crystalline marble containing the silicate minerals irregularly grouped or distributed in bunches.

Shales and slates, especially of the clayey or argillaceous type, may be changed

to hard and dense rock having a conchoidal fracture, and of dark or black color, called *hornstone*; or, if of a light gray to greenish color, it is termed *adinole*. Frequently, however, the change is to a hard and compact, fine-grained rock, called *hornfels*, containing andalusite, staurolite, biotite, etc., in which all visible evidence of bedding may be lost. This metamorphism gradually diminishes with distance from the contact, the only evidence of change shown being the development of a knotty structure in the rock, which gradually fades into the unaltered rock beyond.

Sandstones, especially the pure quartzose varieties, are usually changed to quartzites at the contact.

Igneous and metamorphic rocks are, as a rule, less altered by contact metamorphism, but there are many exceptions to this statement and, in some cases, rather notable effects are produced.

General or Regional Metamorphism

Over many parts of the earth are extensive regions of rocks that have been more or less profoundly altered and which, because of great areal extent involved and the character in part of changes produced, cannot be ascribed to local or contact metamorphism. A typical region of widespread and profound alteration of rocks is the crystalline province of the eastern United States, but local or contact metamorphism within this province is by no means lacking. Another area is found in the Lake Superior region, in which occurs important iron-ore deposits (Chapter XVII). The principal metamorphic rocks composing such extensive regions are gneisses, crystalline schists, slates, etc. Alteration on such an extensive scale is known

as *general or regional metamorphism*, and applies to the reconstruction of rocks over extensive areas.

The principal effects of regional metamorphism are crystallization and recrystallization involving the formation of new minerals and the production of foliated structure, such as schistosity, gneissoid structure, slaty cleavage, etc. (discussed on pages 125, 198, 199), which result in the development of gneisses, schists, slates, etc. (See under Metamorphic Rocks in Chapter II.) Ordinarily the chemical composition of the rock is not much

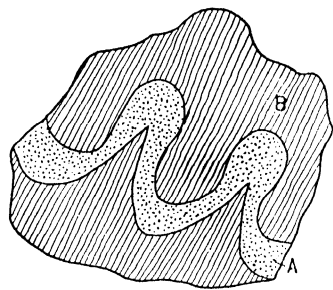

FIG. 119. — Slate showing fine cleavage lines, and layer of calcareous quartzite, showing crumpling of bedding planes. (After Dale).

affected by metamorphism, although the changes may result in the loss of some substances, especially the volatile ones, and the addition of others.

Under the conditions of regional metamorphism the original characters of the rocks are frequently completely obscured or destroyed, so that it becomes difficult, if not in some cases almost impossible, to state with certainty whether the original rock was a sedimentary or igneous one. These are changes which take place at depth below the surface under conditions of deep burial in the anamorphic zone, from long and continued action of earth movements and pressure; liquids and gases, especially water; and heat, which are discussed above (pages 211, 212). The rocks are subsequently exposed at the surface through erosion, and most of those now exposed over many parts of the earth are among the older rocks of the earth's crust.

TOPOGRAPHIC AND GEOLOGIC MAP AND SECTION

No attempt is made in this book to go into the methods of topographic and geologic surveying, since these are available in any one of several excellent texts.

Topographic (base) map. -- Some form of an accurate base is highly desirable and in most cases necessary for the mapping of the geology of any area that is being studied. The best basis for geological work is a topographic map of the type published by the U. S. Geological Survey. If the topography of the base map is inaccurate, the geological lines must necessarily be distorted.

The features represented on the topographic map of the U. S. Geological Survey are of three distinct kinds: (1) Inequalities of surface, called *relief*, as plains, plateaus, valleys, hills, and mountains; (2) distribution of water, called *drainage*, as streams, lakes, and swamps; and (3) the works of man, called *culture*, as roads, railroads, boundaries, villages, and cities.



The relief is indicated by contour lines, that is, lines of equal elevation. The interval between contour lines will vary according to the purposes for which the map is designed and the surface character of the area mapped, whether the relief is slight, moderate, or very strong. In general, with areal mapping on a scale of one inch equals a mile, convenient contour intervals may be 50 or 100 feet. Frequently, however, in the case of property and mine maps, the requirements necessitate a larger scale in order to include more detail when the contour interval may be made smaller, 10 or 20 feet.

Geologic map. -- A good geologic map, to be of practical use and value, should show the following features: (1) The boundaries and therefore areal distribution of the rock masses (formations) on the surface; (2) structural data, such as dip and strike of beds and of schistosity in schists and gneisses, structure axes, faults, zones of crushing, brecciation, etc.; (3) economic data, such as outcrops of ore bodies and ore-bearing formations, locations of mines, quarries, gravel pits, prospect pits, etc.; also mills, breakers, etc. Dip and strike of the ore bodies should be indicated and the outline and type of mineralization should be represented as far as possible. If the area mapped contains coal or oil, it is important to determine accurately the underground structure so that the depth to a particular bed may be shown and the underground structure so indicated on the map. (4) Accompanying structure sections which show the distribution of geologic formations at the surface, and their attitude and position below the surface.

The geologic maps prepared by the U. S. Geological Survey represent the geology shown, by colors and conventional signs printed on the topographic base map, the distribution of rock masses on the surface of the land and, by means of

structure sections, their underground relations, so far as known, and in such detail as the scale permits. The kinds of rock distinguished on the map are igneous (extrusive from intrusive), sedimentary, and metamorphic.

Conventions and symbols.—There should be uniformity as far as possible in the usage of conventional signs in the making of both topographic and geologic maps. For the preparation of geographic maps it is well to use the conventional signs adopted by the U. S. Geographic Board, which are published and for sale by the U. S. Geological Survey at Washington. In the preparation of geologic maps it is desirable that the usage of symbols and abbreviations by the U. S. Geological Survey be followed. Reference to the folios and other publications of the Federal Survey will make plain this usage.

Boundaries between rock formations, mapable units, should be indicated on the map by solid (unbroken) lines when accurately observed and located; and by broken lines or lines of fine dots when not accurately located. Faults may be represented by heavy solid lines when their exact position has been determined, and by a series of heavy broken lines and dots when not accurately determined. Veins, when accurately located, may be shown by a system of arrows; thus, , so oriented as to indicate the direction of strike. In case veins of different kinds occur in the area being mapped, it is desirable to distinguish between them, which can conveniently be done by arrows of different colors. Dikes may  be shown by very heavy solid or broken lines in color if preferred, according to whether they are accurately or doubtfully located.

Each formation is shown on the maps of the U. S. Geological Survey by a distinctive combination of color and pattern and is labeled by a special letter symbol.

“Patterns composed of parallel straight lines are used to represent sedimentary formations deposited in the sea, in lakes, or in other bodies of standing water. Patterns of dots and circles represent alluvial, glacial, and eolian formations. Patterns of triangles and rhombs are used for igneous formations. Metamorphic rocks of unknown origin are represented by short dashes irregularly placed; if the rock is schist the dashes may be arranged in wavy lines parallel to the structure planes. Suitable combination patterns are used for metamorphic formations known to be of sedimentary or of igneous origin. The patterns of each class are printed in various colors. With the patterns of parallel lines, colors are used to indicate age, a particular color being assigned to each system.

The symbols consist each of two or more letters. If the age of a formation is known the symbol includes the system symbol, which is a capital letter or monogram; otherwise the symbols are composed of small letters.”¹

Strike and dip are conveniently represented in a single symbol, thus, , in which the horizontal line open at both ends indicates direction of strike and the arrow that of dip. Measurements of dip and strike may be recorded on the

map in the following way:

$$\begin{array}{c} \text{N.10 E} \\ \hline \downarrow \\ 30 \end{array}$$

Sections.—In geologic mapping it is not enough to show cartographically the areal distribution of rock formations, but it is important, and in most cases necessary, to represent by sections along a particular direction or directions on the map the arrangement or structural relations of the rocks below the surface. A section exhibiting this arrangement of the rocks in the earth is called a *structure section*. The structural relations of rock masses may be observed in natural and artificial cuts, but the geologist is not entirely dependent upon these for his information concerning structure. If the manner of formation of the rocks and their relations on the surface are known, their relative positions beneath the surface can be inferred and

¹ See Geologic Atlas Folios issued by U. S. Geol. Survey.

sections can be drawn representing the structure. The patterns used for sections are those shown in Fig. 120.

Geologic maps are frequently accompanied by *columnar* (vertical) sections, which describe very briefly the formations that occur in the area; such as character of the

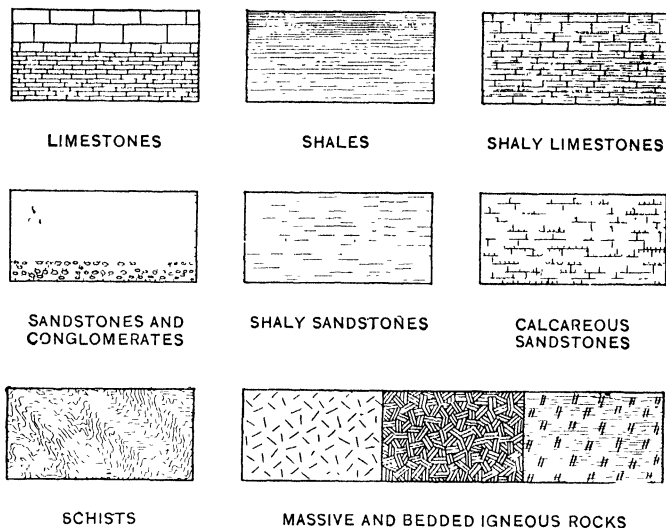

Fig. 120.—Symbols used in sections to represent different kinds of rocks.

rocks, thickness of the formations expressed in feet; and order or age of accumulation, the oldest being at the bottom and the youngest at the top.

Method of constructing geologic maps and sections.—In the construction of a geologic map, the geologist rarely finds a large number of closely-placed outcrops; on the contrary they are scattered over the country, sometimes near together, sometimes far apart. Each of these must be carefully located, the kind of rock noted, and the strike and dip measured wherever possible.

From the plotted outcrops the boundaries of the several formations are to be determined as accurately as possible. Where the geologic structure is very complex, and where solid rock outcrops are few, due to a widespread mantle of unconsolidated surface deposits, accurate mapping is sometimes difficult even to the expert.

In the location of such boundaries where the formations are not in actual contact, the geologist often makes use of topographic features. The contact of two formations may be a line of weakness, and its position indicated by a valley or other depression. Again, in some regions the nature of the vegetation covering different formations is quite characteristic, or occasionally residual soils may serve as a guide. On hillsides the difference in resistance to weathering may also yield characteristic results, a series of firm, durable beds giving steep slopes, while a less resistant series yields gentle ones.

In addition to natural exposures the geologist also makes use of all additional data, such as those obtainable from railway cuts, drilled wells, tunnels, mines, etc.

In constructing a geologic section, for the purpose of ascertaining the structural features of a region, it is preferable to draw this normal to the line of strike if the rocks are sedimentary.

Such a structure section is often desired by an engineer who is engaged in excavating or tunneling. He may have at his disposal a geologic map, already prepared, from which he can construct a geologic section with fair accuracy.

The first step in constructing a section showing underground structure along any given line is to draw a surface profile, and lay off upon it the intercepts of the different formations. The next step is to interpret the position and relationships of these rocks. To do this it is necessary to consider: (1) The position of the sedimentary strata, whether flat or folded; (2) faults; (3) igneous rock masses; (4) unconformities; and (5) basal metamorphic and igneous rocks.

1. If the sedimentary beds are horizontal, they are drawn simply as horizontal layers, one upon the other, and if the surface is perfectly level, a geologic map of such a region would show but one formation (erosion unconformity and faulting excepted). If additional formations are shown on the geologic map of an area of flat-lying strata, it is because they have been exposed by erosion. In such cases, then, the deeper the valley the older the beds exposed (if the beds are in their normal order of deposition), and on a map of such a region the different formations will often show a peculiar sinuous outline, with tongues extending up the valleys of the tributary streams. A somewhat similar disposition of formation boundaries would be noticed in an eroded region of slightly-folded rocks.

Many strata are more or less folded, and in order to represent the various anticlines (p. 151), synclines (p. 151), and monoclines (p. 152), into which the strata are folded, it is necessary to draw them so that the older beds dip under the younger ones. This is because of the fact that in sedimentary rocks the older ones were laid down first and the younger ones on top of them. An exception to the rule that in tilted beds the older dip under the younger, is found in the case of an overturned fold where, by reference to Fig. 76, it can be seen that in one limb of the fold the strata are inverted. This exception together with other irregularities in strike and dip are often shown by symbols (p. 210). The steepness of the dip, if not shown by these symbols, may be judged by the comparative widths of the different outcropping belts of a bed or formation, the wide areas of outcrop indicating low dips, and the narrow ones steep dips because a formation often maintains a uniform thickness throughout a small area.

Having determined the direction in which the beds dip it is necessary only to connect different parts of the same formation in order to determine the character of the folding. If, for example, a given bed is bordered on either side by beds of younger, but themselves of similar age, it signifies that the older bed dips in both directions under the younger ones and hence we have an anticline.

2. Faults, as mentioned on page 174, are indicated on the map by a solid or short dashed line. In drawing the section, it is carried along until the fault line is reached where it terminates abruptly and the construction is begun independently on the other side of the fault. We cannot tell from the geologic map what the dip of the fault plane is, or whether it represents a normal or reverse displacement. These can only be determined from the field evidence.¹

3. Of the various igneous rock masses, flows and sills show the same general relations on maps and sections as sedimentary rocks, provided they occur as members of a normal succession. Dikes, however, appear on the map as bands of color, cutting haphazardly across the other formations, and are drawn in the section as bands of uniform width with nearly vertical dips. The outcrops of a laccolith (p. 53), appear more rounded in outline, and evidence of its existence is afforded chiefly by the upturning of neighboring formations. It can be drawn as shown in Fig. 52. The larger intrusive masses, such as stocks, bosses (p. 55), and batholiths

¹ The Geologic Atlas Folios issued by the U. S. Geological Survey contain not only geologic maps, but also structure sections across the map, and should be referred to by the student or reader.

(p. 56), appear on the map as more or less irregular outcrops of igneous rock, the position and outline of which seem to have been wholly unaffected by the adjacent formations, and they are indicated on the section (Fig. 121) as having irregular boundary lines, with gradually downward increasing size.

4. Unconformities are usually indicated by the absence at some point on the map of one or more formations which should be present in the normal order of succession. Corroborative evidence may be change in dip and strike. Fig. 109 indicates an unconformity.

5. Mention might be made, lastly, of those metamorphic and igneous rocks, which form the floor upon which all sediments were laid. These, when known to be present, are represented in the section as masses underlying the oldest sediments indicated on the map. Their presence is known by their appearing at the surface where the younger rocks have been removed by erosion, or their becoming known through underground workings or borings.

List of References on Structural Features and Metamorphism of Rocks

1. Grabau, A. W., *A Text-book of Geology, Part I, General Geology*, Boston, 1920. (Heath & Co.) 1a. Chamberlin and Salisbury, *Geology*, Vols. I and II, Henry Holt & Co., N. Y., 1904.
2. Dana, James D., *Manual of Geology*, 4th edition, American Book Co., N. Y., 1895.
3. Farrell and Moses, *Practical Field Geology*, McGraw-Hill Book Co., N. Y., 1912.
4. Geikie, James, *Structural and Field Geology*, D. Van Nostrand Co., N. Y., 1905.
5. Geikie, A., *Text-book of Geology*, 4th edition, Vols. I and II, Macmillan & Co., Ltd., London, 1903.
6. Hayes, C. W., *Handbook for Field Geologists*, revised by Sidney Paige, John Wiley & Sons, N. Y., 1921.
7. Leith, C. K., *Rock Cleavage*, Bull. 239, U. S. Geological Survey, 1905.
8. Leith, C. K., *Structural Geology*, Henry Holt & Co., N. Y., revised edition, 1923.
9. Pirsson-Knopf, *Rocks and Rock Minerals*, 2nd edition, 1926, John Wiley & Sons, N. Y.
- 9a. Leith, C. K., and Mead, W. J., *Metamorphic Geology*, N. Y., 1915 (Henry Holt and Co.).
10. Reid, Davis, Lawson, and Ransome, *Report of the Committee on the Nomenclature of Faults*, Bull. Geol. Soc. Amer., Vol. 24, 1913, pp. 163-186.
11. Pirsson and Schuchert, *Text-book of Geology, Part I, Physical Geology*, John Wiley & Sons, N. Y., revised edition, 1929.
12. Willis, B. and Willis, R., *Geologic Structures*, 2nd edition, 1929, McGraw-Hill Book Co.
13. Van Hise, C. R., *A Treatise on Metamorphism*, U. S. Geol. Survey, Monograph XLVII, 1904.
14. Van Hise, C. R., *Principles of North American Pre-Cambrian Geology*, 16th Ann. Rept., U. S. Geol. Survey, Pt. I, 1894-1895, pp. 571-843.

CHAPTER IV

ROCK-WEATHERING AND SOILS

Introduction. — When exposed for a sufficient length of time to the atmosphere, all rocks undergo decay from disintegration and decomposition, and are ultimately converted superficially into a loose, incoherent mixture of sand, gravel, and clay, the upper few feet of which is called the *soil*. If the erosive action of water, wind or ice is not too excessive, a mantle of variable thickness of decayed rock material overlies the hard and fresh rock into which it usually passes gradually. The southern Appalachians furnish an excellent illustration of this, the rocks being very generally covered with a mantle of loose residual rock material of variable thickness (frequently exceeding 100 feet). This loose, decayed-rock mantle must often be removed before quarrying can be commenced.

The changes involved in the weathering of rocks are in part physical and in part chemical in nature, the latter representing a readjustment from unstable to stable compounds under prevailing surface conditions. The processes involved may be simple or complex, and are confined almost entirely to the belt of weathering (p. 212), or surface zone, which extends from the surface to the level of groundwater (Chapter VI). They are wholly atmospheric and are operative on all land surfaces above sea-level, becoming usually quite, if not entirely, inactive, at comparatively slight depths.

Importance of rock weathering. — Rock weathering is of fundamental importance from the purely scientific as well as from the economic standpoint. In the study of soils, building stone, and the superficial portions of ore-deposits, a knowledge of the principles of weathering is indispensable.

In all engineering surface projects, in the selection of stone for structural and decorative purposes, in mining and quarrying operations, and in problems of water supply, as well as in excavations of all kinds, the engineer is concerned either with the direct results of rock weathering or else its probabilities as affecting any stone used in constructional work

WEATHERING PROCESSES

Definition of weathering. — All physical and chemical changes produced in rocks, at or near the surface, by atmospheric agents, and which result in more or less complete disintegration and decomposition, are commonly grouped under the general term of *weathering*. The action of physical agents alone is called *disintegration*, which results in the rock breaking down into smaller particles without destroying their identity. On the other hand, the action of chemical agents destroys the identity of the mineral particles by breaking them up into new compounds, and is known as *decomposition*.

In most cases disintegration and decomposition are concurrent, but for a given locality one may predominate over the other. Thus, in the arctic regions, disintegration is the dominant process by which rock masses are broken down, while in tropical regions, decomposition becomes the important process. Again, the former predominates in the arid climate of the west, while the latter is the dominant factor in the east.

Mechanical Agents

The changes produced in rock masses by physical agents result in disintegration, and ultimately the rock crumbles into fine particles of the consistency of sand and powder, which may consist of fresh mineral grains. The principal mechanical agents involved in the disintegration of rocks are (1) temperature changes, (2) mechanical abrasion, and (3) growing organisms.

Temperature changes. — The disintegration of rocks through temperature changes may result from (1) unequal expansion and contraction of the component minerals, and (2) expansion caused by alternate freezing and thawing of interstitial water.

Expansion and contraction. — Most rocks are composed of an aggregate of minerals each one of which has a different rate of expansion. Unequal expansion and contraction of the individual minerals result both from diurnal and seasonal changes of temperature. In the crystalline rocks the mineral particles are crowded together closely and many of them expand unequally in different directions. When, therefore, the temperature rises the minerals crowd against each other with almost irresistible force, and when the temperature lowers they contract and draw farther apart from one another. The result of these alternating temperatures producing expansion and contraction is to weaken the rock, and the formation of small cracks into which

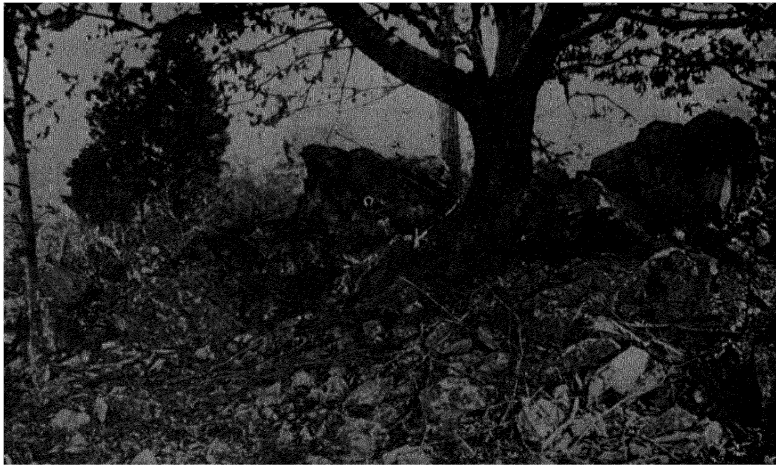

PLATE XXX, FIG. 1. — Quartzite broken by temperature changes, frost and plant roots. Monroe, N. Y. (H. Ries, photo.)

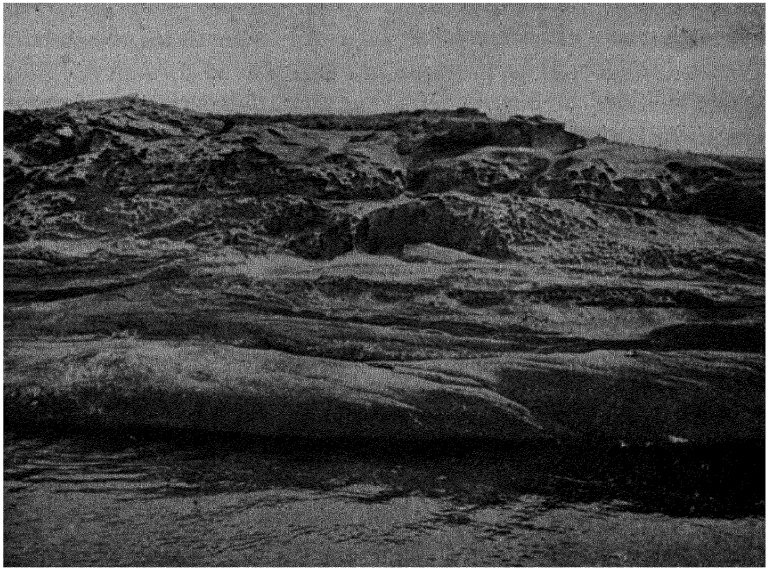

FIG. 2. — Concretionary sandstone, weathered by solution and wind action. Snake Island, near Nanaimo, B. C. (H. Ries, photo.)

water may percolate and chemical action set up, or into which roots may penetrate and further aid in disintegration.

The coefficient of cubical expansion for some of the common rock-forming minerals is given by Clarke as follows:

Quartz.....	.0000360	Calcite.....	.0000200
Orthoclase.....	.0000170	Garnet.....	.0000250
Hornblende.....	.0000284	Tourmaline.....	.0000220

Bartlett has determined experimentally the actual expansion of granite, marble, and sandstone to be as follows:

Granite.....	.00004825 inch per foot for each degree F.
Marble.....	.00005668 inch per foot for each degree F.
Sandstone.....	.00009532 inch per foot for each degree F.

While these figures indicate only a very small rate of expansion, if continued from season to season through a long period of time, the weakening effect produced will have an appreciable bearing upon the economic importance of the stone. Such action will finally result in opening invisible cracks and crevices in the rock, or, it may be, in pulling the stone away from the mortar, which will afford ready entrance for water and thereby pave the way for decay, and final disintegration of the stone must result.

The expansion of stone when heated is sometimes recognized by engineers, in placing elastic joints in long walls of masonry.

Expansion due to alternate freezing and thawing.— All rocks are more or less porous and are capable of absorbing varying amounts of water. In passing from the liquid to the solid state, water expands with a force equal to about 150 tons to the square foot. One cubic centimeter of water at 0° C. occupies 1.0908 cm. in the form of ice at 0° C., which is equivalent in expansion to about one-tenth of the original volume. The effects produced on rocks from the action of continued freezing and thawing when the stone is saturated with water are much greater than from expansion and contraction through diurnal temperature changes described above.

Water gains access into rocks through the openings and spaces of various kinds, namely, pores, bedding and foliation planes, and jointing and other fissile planes. The latter form of openings (structures) permits a freer circulation of water than the pore spaces in the rock, and at times the water may collect in these passages more rapidly than it can be carried away, so that if the temperature lowers to the freezing point it congeals into ice, which acts as a wedge to force the walls farther apart. The freezing of water, however, in these struc-

tures in building stone, except in some stratified and foliated rocks, is usually attended with less danger than from freezing of water in the pores.

In rocks whose pores are large in size as well as straight, the water of saturation may be expelled with comparative readiness, but when the cavities are of subcapillary size the water is retained with greater tenacity; hence, the danger from freezing in the latter becomes increasingly great. Ordinarily, then, the danger from freezing of water in rocks used for constructional purposes becomes increasingly great as the pores approach those of subcapillary size (see further in Chapter XI). It should be emphasized, however, that unless the pores of the rock are filled with water at the time of freezing and there is no chance for any to escape the ice formed does no harm.¹

The amount of water contained in the pores at a given time depends upon the quantity of water initially absorbed, the time that has elapsed since absorption, the condition of the atmosphere, the size and shape of the pores, and the position of the stone. It is only in exceptional cases that the stone in the wall of a building is saturated (Buckley).

Named in their order of importance, then, it is possible that the factors in estimating the danger from freezing and thawing are: (1) size of pore spaces, which controls the rate at which the interstitial water is expelled, (2) the amount of water contained in the pores at the time of freezing, and (3) the total amount of pore space.

Disintegrating effect of soluble salts. — In regions of limited rainfall, like parts of the southwestern United States, the waters usually contain abnormal quantities of soluble salts. When these salts crystallize in the pore spaces of the rocks they exert a disintegrating effect similar to that of frost or ice, hence such effects are frequently experienced in the West where alkalies are present in the soil. Both porous rocks and brick are disintegrated by this action. Carus-Wilson describes the case of a porous volcanic tuff into which sea water ascended by capillarity. On evaporating salt crystals were deposited which flaked off the stone.²

Effects of frost and temperature changes. — As already explained, small cracks may be started by temperature changes, and into these

¹ For tests of frost action on sand see Ferry, Proc. Am. Soc. Civ. Engrs., XLII, p. 1320, 1916. In order to see whether there was any danger of frost heaving sandy ground under the Yale bowl, a bottle filled with sand was frozen with different quantities of water in it. Not until the voids were 75 per cent filled was there enough swelling to crack the bottle.

² Nature, CVIII, p. 66, 1918.



PLATE XXXI, FIG. 1. — Talus of weathered schist, French Pyrenees. The rock has broken down to a soil which can be tilled, but has to be terraced to prevent erosion. (H. Ries, photo.)

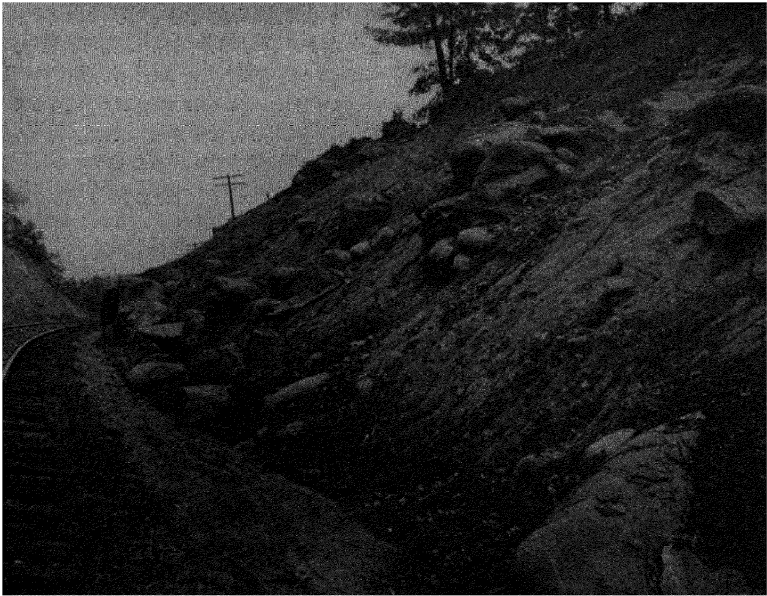

FIG. 2. — Diabase dike, Virginia. The weathering has broken the rock down to a mass of boulders and clay. (T. L. Watson, photo.)

as well as other fissures the frost works its way, breaking down the stone into a number of large and small angular fragments. If the rock surface is flat or gently sloping, the angular débris lies where it was formed (Plate XXX, Fig. 1), but if the disintegration takes place on a steep hillside, or the face of a cliff, the material falls to the bottom of the slope or cliff and builds up a talus pile (Plate IX, Fig. 2 and Fig. 63), which in time may assume large size (Plate XXXI, Fig. 1), and even eventually break down to a fertile soil.

The much-jointed character of the rocks in some mountain regions causes frequent and dangerous rock falls, as the water freezing in them pries off large and small pieces of rock.

Foliation planes in schist, and bedding planes in sandstone, are good examples of lines of weakness sought out by frost, so that rocks of this sort frequently scale off when set in a building on edge, instead of on the natural bed.

Mechanical abrasion.—Mechanical abrasion is one of the most important agents in the disintegration of rock masses. It is accomplished mainly by wind and running water working concurrently with the other agents of disintegration.

In many parts of the world, the wind does considerable work in removing the fine-grained products of rock decay or other sandy deposits. Not only does it remove this loose material, but often drives it with such force against rock surfaces as to wear them down by mechanical abrasion. The etching and engraving of glass by artificial sand blasts well illustrates the nature and potency of this agent. Many authors have put on record the work wrought by this agent. J. Walther has described the polishing effect of the wind-blown sand on the Egyptian monuments; M. Choisy noted similar action on the rocks by the blown sand of the Sahara; Gilbert has observed the peculiar wearing away from the erosive action of the wind of the blocks of sandstone and limestone in the western United States; Endlich has noted some interesting results wrought by wind action on rocks in Colorado; and Eggleston observed that the gravestones in many of the churchyards of New York City are worn nearly smooth and the inscriptions rendered almost illegible by this agent. Finally, as illustrative of the work done by wind-blown sand, mention may be made of telegraph poles that have been worn nearly through by this agent.

The work accomplished by this agent is naturally most effective in arid regions, which are generally characterized by an almost total absence of vegetation. Its effects, however, are oftentimes present in

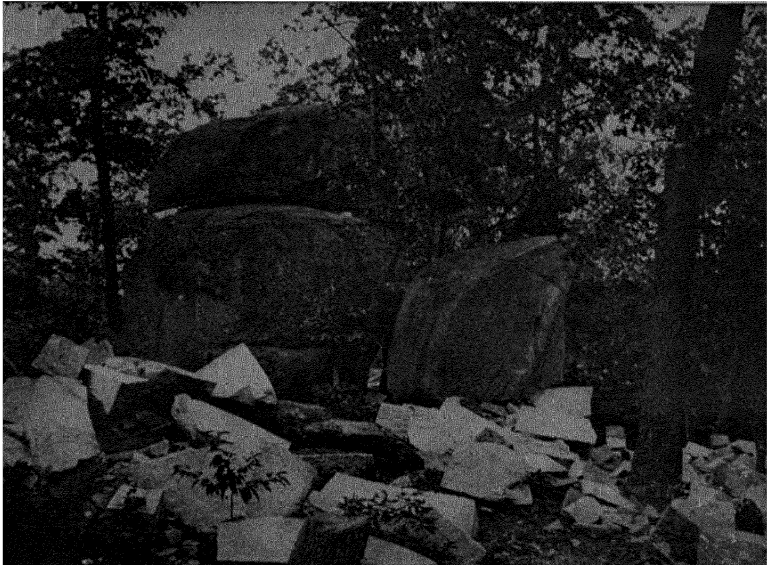

PLATE XXXII, FIG. 1. — Granite boulders produced by disintegration and decomposition, Faith, N. C. (T. L. Watson, photo.)

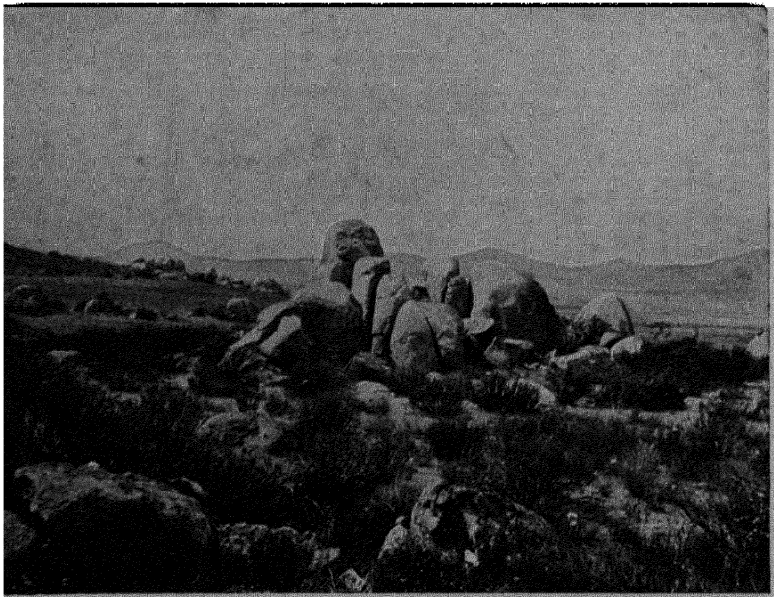

FIG. 2. — Granite boulders produced mainly by disintegration in an arid climate, Winchester, Cal. (H. Ries, photo.)

our humid Atlantic coast climate, where the beach sands are caught up and driven with much violence before the wind. In the case of one of the light-houses on Cape Cod, the impact of the wind-driven sand was so great on the heavy glass in the windows as to render some of them no longer transparent, and necessitating their removal in a few instances.

Naturally the action resulting from wind abrasion is a very slow one, but, after long lapses of time, and under constant blast, the effects are manifest. Those who have been exposed to sandstorms in the desert will readily testify to the cutting action of wind blown sand.

Growing organisms. — Both plants and animals aid to some extent in the breaking down of rock masses, through action that is partly physical and partly chemical. While they are not usually the principal agents involved in the processes of rock decay, yet they become at times important factors in such destruction. The chemical action resulting from these organisms is mainly that of deoxidation and solution.

An important function of plant growth is the retention of moisture, whereby the rock-surfaces are kept constantly damp, and thus solvent action by the water is promoted. Similarly chemical decay among rocks is promoted by the formation of vegetable mould (humus) derived from the decay of plants, by the retention of moisture, by furnishing carbon dioxide to the water, and by a leaching process which is reducing in action.

The physical action exercised by plants results principally from the force exerted by the penetration of their roots into cracks and crevices, which tend to wedge apart the rock, and, it may be, in the total dislodgment of varying size fragments from the parent ledges. This action sometimes results in partial detachment of parts of the masonry from the walls of buildings and other structures, where creeping vines are allowed to cover the structure. The small rootlets of a tree penetrating a crevice may produce little effect, but as these grow and expand they often exert a powerful force.

While plant growth may promote rock decay, it may also exercise a protective action. Where vegetation is abundant, the erosive action of wind and rain is retarded. Such protective influence is well shown in reclaiming lands over parts of France by planting trees on the extensive sand hills, in order to prevent further encroachment. Similar protection is afforded by the sage brush and other forms of plant growth over the sandy tracts of the western United States. In mountain districts, avalanches are sometimes prevented by plant growth. On buildings the main function of plant growth is to attract moisture to the wall.

Chemical Agents

Normal atmospheric air consists chiefly of a mechanical mixture of nitrogen and oxygen in the proportion of four volumes of nitrogen to one of oxygen. In addition to these, there are usually present small quantities of other substances, chief among which are water vapor and carbon dioxide. Of these oxygen and carbon dioxide are much the most important chemically active compounds, the most abundant constituent nitrogen being chemically inactive under normal atmospheric conditions.

Besides the gaseous solutions of oxygen and carbon dioxide, the water solutions usually contain variable amounts of different substances, especially the carbonates of the alkalies and the alkali earths, and acids, such as hydrochloric, sulphuric, nitric, etc., which are active agents in decomposing rocks.

The most important chemical reactions that take place in the belt of weathering as the result of the action of various agents are: (1) Hydration, (2) oxidation, (3) carbonation, and (4) solution. These are discussed below in the order named.

Hydration. — By hydration is meant the assumption of water which results in the production of hydrous minerals. Among the important hydrous minerals formed are many silicates, such as kaolinite, serpentine, talc, chlorite, zeolites, etc.; oxides, especially those of iron and aluminum, such as goethite, turgite, and limonite, diaspore and gibbsite; and of the sulphates, gypsum. The water for hydration is derived chiefly from the atmosphere and the reaction is one of the most extensive and important that takes place in the belt of weathering. A simple case of hydration is represented by the change of anhydrite to gypsum when the former is exposed to water, and has been the source of gypsum in many commercial deposits. Thus,

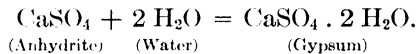

From the above explanation it will be understood that many deposits which show gypsum on the surface may pass into anhydrite with depth, and this fact has been noted at a number of localities.

Another common example of hydration is that involved in the change of pyrite to limonite as explained under **Oxidation** below, or in the change of feldspar to kaolinite. This latter change is brought out in the chemical equation given under **Carbonation** on a subsequent page.

By comparing analyses of fresh and decayed rock, it will be found

that an increase in water invariably occurs, the amount of water increasing with the stage of decay. By comparing the chemically combined water in the analysis of a fresh rock, and that shown in analysis of residual clay derived from it, the increase due to hydration is clearly seen. In rock decomposition, therefore, hydration is one of the main factors, and, when not accompanied by a loss of constituents through solution, it involves expansion of volume and great liberation of heat, becoming thereby a physical agent of decay. In simple hydration the volume increase ranges from a very small per cent to as high as 160 per cent, but commonly the increase in volume is less than 50 per cent (Van Hise).

Although hydration involves increase of volume, the rocks so affected do not always have room to expand. Engineers engaged in tunneling have sometimes noticed that apparently fresh rock when brought to the surface crumbles rapidly. This is because the rock, whose minerals are partly or wholly hydrated, was under strain while in the ground, and therefore disintegrates rapidly when released. This slaking has been observed by Merrill in the granites of the District of Columbia and by Derby in sedimentary rocks in the railway cuttings of Brazil. Hydration caused by percolating water may at times cause swelling and heaving ground in tunnels or mines.

Branner quotes the *Compte de la Hure* who gives it as his opinion that some of the hills of Brazil have actually increased in height through hydration. Merrill "has calculated that the transition of a granite rock into arable soil, provided the same took place without loss of material, must be attended by an increase in bulk amounting to 88 per cent." Concerning the disintegration of the District of Columbia rocks, Merrill says: "Granitic rocks in the District of Columbia have been shown by the author to have become disintegrated for a depth of many feet with a loss of but comparatively small quantities of their chemical constituents and with apparently but little change in their form of combination. . . . Aside from its state of disintegration, the newly formed soil differs from the massive rock mainly in that a part of its feldspathic and other silicate constituents have undergone a certain amount of hydration."

Dehydration, the opposite reaction of hydration, while not recognized as an important process in weathering may take place in regions of high temperature, such as in some of the surface hydrous iron compounds of the southern Appalachian soils.

Oxidation. — The process of oxidation is promoted by the presence of moisture and is usually accompanied by hydration. All rocks which carry iron in the form of sulphide (pyrite, marcasite, and pyrrhotite)



PLATE XXXII, FIG. 1. — Granite quarry, Manchester, Va. Shows sheeted structure of granite and covering of residual clay. (H. Ries, photo.)

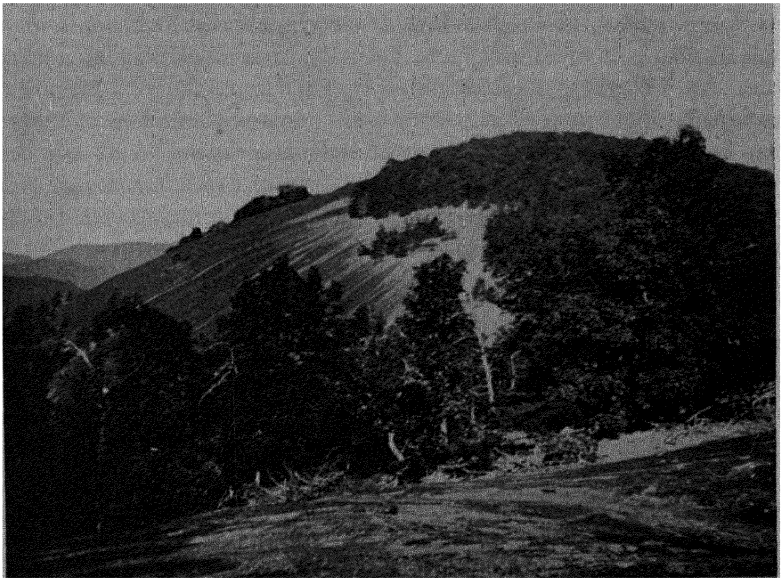
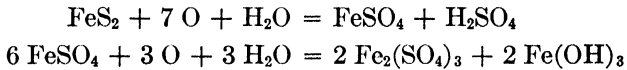

FIG. 2. — Stone Mountain, Wilkes County, N. C. A granite dome, which has resisted the weather better than the surrounding rocks. (T. L. Watson, photo.)

and as ferrous oxide in many silicates (pyroxene, amphibole, micas, and olivine) and carbonates, are oxidized in the belt of weathering. The process is also of great importance in the surface alteration of ore-deposits (see Chapter on Ore-Deposits).

The two following equations represent oxidation, and the second one in addition involves hydration:



The principal cause of weathering in these cases is largely the affinity of iron in the ferrous state for oxygen, which finally results in a chemical combination of the two, forming hydrated ferric oxide. The bright red and yellow colors of the residual products of rocks con-

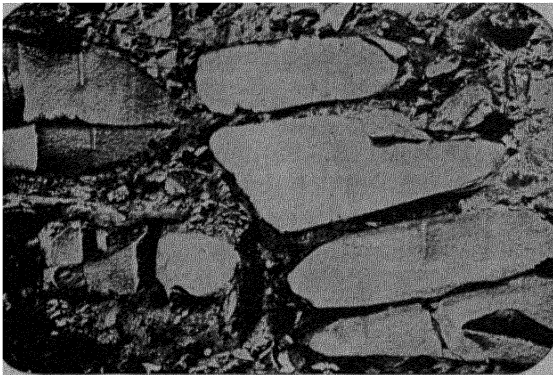

FIG. 122. — Granite boulders produced by weathering. The material surrounding them is decomposed rock. (T. L. Watson, photo.)

taining these minerals are due to the formation of iron oxides by oxidation. The red and yellow soils derived from the deeply-weathered crystalline rocks of the Piedmont province in the southern Appalachians furnish an excellent illustration of the oxidation of iron compounds to ferric oxide. The early stages of oxidation accompanied by hydration may frequently be observed in the "sap" portions of granite and other siliceous crystalline rocks used for building stone containing biotite or other ferromagnesian minerals, in the slight discoloration from liberated iron oxide of the iron-bearing minerals.

Another frequent and familiar example of oxidation is that of the

iron sulphides (pyrite, marcasite, and pyrrhotite), which are common constituents of many rocks. The iron becomes oxidized to the hydrated sesquioxide form (limonite, turgite, or goethite) with the liberation of sulph-acids which, eventually, through oxidation, form sulphuric acid, and which if in sufficient amount immediately becomes a free destroyer of the rock in which the mineral liberating it occurs. The first stage in the oxidation of the sulphides is the formation of the corresponding sulphates. When formed in building stones, these sulphates sometimes cause an unsightly scum on the surface of the building (see Chapter XI).

Oxidation may be accompanied by either decrease or increase in volume. Probably decrease in volume usually attends the oxidation of carbonates and sulphides, but oxidation of silicates not involving a loss from solution may be accompanied by increase in volume.

The oxidation of sulphides is a most important process in the weathering of many ore-deposits (Chapter XVII), for the reason that the sulphates of the metals thus formed are carried in solution to lower levels, where, under favorable conditions, they may be reprecipitated as sulphides.

Deoxidation. — Deoxidation, the reverse of oxidation, is a less frequent reaction in the belt of weathering than oxidation. When carrying organic matter in solution water becomes a reducing agent, and ferric iron is reduced to the ferrous condition, which in the presence of carbon dioxide unites to form ferrous carbonate (siderite). From this source and by this process ferrous carbonate may be derived for the material of chalybeate (iron) springs, and the iron-carbonate deposits (black-band ore and clay ironstone) so often associated with coal beds. Frequent illustration of the reaction is found in the bleaching of red soils to gray or white ones, and in the local bleaching of some ferruginous sands and sandstones. By a similar process ferrous sulphates may be converted into sulphides.

Carbonation. — Carbonation, the union of carbonic acid with bases to form carbonates, takes place on a vast scale in the belt of weathering, and is one of the dominant reactions. It consists chiefly in the substitution of carbonic for silicic acid in the silicates. It has been demonstrated experimentally that carbon dioxide in aqueous solution attacks many minerals, such as the feldspars, hornblende, olivine, serpentine, muscovite, biotite,¹ etc., among the silicates, under ordinary

¹ The presence of carbon dioxide in water is not always necessary to cause the decay of these minerals.

This dissolved mineral matter in the belt of weathering may be disposed of in one of several ways: (1) It may be delivered in part to the oceans by means of surface streams, (2) much of it may be carried lower down by the downward percolating waters into the belt of cementation and there precipitated and deposited, and (3) it may be partly precipitated in the belt of weathering as in the formation of cave deposits, and those of the oxides of iron, aluminum, and manganese. The process of secondary enrichment of such importance in many ore-deposits (Chapter XVII) is a phase of this process.

Only a very few minerals are readily soluble in pure water, but chemically-pure water does not exist in nature, and when carrying in solution certain materials, such as carbon dioxide, organic matter, etc., the solvent power of water is greatly increased.

As early as 1848 the Rogers brothers showed the power of pure water to appreciably dissolve many of the commonly occurring silicates, and that within less than ten minutes the action of carbonated water on the same minerals was recognizable.

T. Mellard Reade estimates that the amount of salts annually removed in solution from a square mile of the earth's surface is 96 tons, divided as follows: Calcium carbonate 50 tons, calcium sulphate 20 tons, sodium chloride 8 tons, silica 7 tons, alkaline carbonates and sulphates 6 tons, magnesium carbonate 4 tons, and oxide of iron 1 ton.

In order that some idea may be had of the total amount of solids removed in solution by some of the larger rivers the following table taken from Russell may be cited (see further under Chapter V):

	Tons per year.
Rhine	5,816,805
Rhone	8,290,464
Danube	22,521,434
Thames	613,930
Nile	16,950,000
Croton	66,795
Hudson	438,000
Mississippi	112,832,171

Of all stone ordinarily used for building purposes, limestone suffers most from solution, its solubility being given in the ratio of 1 to 1000 parts in water charged with carbonic acid. This becomes the more apparent when it has been shown that the total solids calculated for European and American river waters is 0.1888 of which 0.088765 part per thousand is calcium carbonate. These figures show that for normal rivers calcium carbonate is approximately one-half of the total solids. The cementing material of some sandstones (calcareous) is dissolved by atmospheric water, causing the rock to crumble into loose sand.

On the other hand, the calcium carbonate of some impure limestones becomes so completely removed by solution, that only a porous skeleton of clayey and siliceous impurities is left. The *rottenstone* used for polishing purposes is an example of this.

The weathering of rocks by solution begins at the surface and also penetrates the rock along joint planes (Plate XXXV, Fig. 1, and Plate LX, Fig. 1).

Summary of chemical decay.— A study of the chemical changes involved in the weathering of siliceous crystalline rocks, by comparing analyses in the usual way of the fresh and correspondingly decayed rock, as shown by Merrill from his own work and that of others, may be summarized as follows:

1. Hydration is an important factor, the quantity of water increasing as the stage of decomposition advances, and in the early stages of weathering it may be the most important factor.

2. The formation of ferric oxide retained as a pigment in the insoluble residual decay through oxidation of ferrous compounds.

3. There is in every case a loss in silica, a greater proportional loss in lime, magnesia, and the alkalies (soda and potash), and a proportional increase in alumina and sometimes iron oxide, resulting on the whole in a decided loss of materials through solution.

4. So far as is indicated by available analyses the total loss of constituents in siliceous crystalline rocks seldom exceeds 60 per cent for the entire rock. In calcareous rocks the loss through solution may amount to 99 per cent in extreme cases.

Chemical study of the various kinds of igneous rocks shows the total losses produced by decomposition, calculated from chemical analyses of the fresh and correspondingly decayed rock, to be as follows:

TOTAL PERCENTAGE LOSSES ACCOMPANYING THE DECAY OF IGNEOUS ROCKS

Rock.	Locality.	Per cent loss.	Authority.
Biotite granite.	District of Columbia.	13.79	Merrill, G. P.
Biotite granite.	Elberton, Ga.	7.92	Watson, Thos. L.
Biotite granite.	Oglesby, Ga.	7.71	Watson, Thos. L.
Biotite granite.	Lexington, Ga.	14.56	Watson, Thos. L.
Biotite granite.	Appling, Ga.	15.84	Watson, Thos. L.
Biotite granite.	Newman, Ga.	38.45	Watson, Thos. L.
Biotite granite.	Oglesby, Ga.	44.72	Watson, Thos. L.
Biotite granite.	Greenville, Ga.	71.81	Watson, Thos. L.
Porphyritic biotite granite.	Camak, Ga.	34.04	Watson, Thos. L.
Porphyritic biotite granite-gneiss.	Coweta, Ga.	35.07	Watson, Thos. L.
Biotite granite-gneiss.	Lithonia, Ga.	26.69	Watson, Thos. L.
Biotite granite-gneiss.	North Garden, Va.	44.67	Merrill, G. P.
Nepheline syenite.	Fouche Mtn. region, Ark.	55.28	Merrill, G. P.
Phonolite.	Assig, Bohemia.	10.26	Lemberg and Merrill.
Diabase.	Medford, Mass.	14.93	Merrill, G. P.
Diabase.	Chatham, Va.	70.31	Watson, Thos. L.
Basalt.	Bohemia.	43.96	Ebelman and Merrill.
Basalt.	Haute Loire district, France	60.12	Ebelman and Merrill.
Diorite.	North Garden, Va.	37.51	Merrill.
Andesite.	Grenada, Windward Islands.	63.09	Harrison and Merrill.
Alnoite.	Herkimer County, N. Y.	26.89	Smyth, C. H., Jr.
Soapstone.	Albermarle County, Va.	52.46	Merrill, G. P.
Soapstone.	Fairfax County, Va.	77.95	Merrill, G. P.

Residual clay and sand.—As a result of the rock being broken down by weathering there forms, as already stated, a mantle of incoherent material, which if clayey in its nature is termed a *residual clay*; if sandy a *residual sand*. If decomposition has been active the product is usually clayey, but if disintegration has been the dominant weathering agent, a sandy material is more likely to result. The character and extent of residual clays are discussed in Chapter XIII.

The following analyses give the composition of three fresh rocks and the residual clays derived from them, but it should be pointed out that one cannot tell from the composition of the clay, what the parent rock was.

ANALYSES OF FRESH ROCKS AND RESIDUAL CLAYS

Constituents.	Gneiss. ¹		Diabase. ²		Limestone. ³		
	Fresh.	Decomposed.	Fresh.	Decomposed.	Fresh.	Decomposed.	
SiO ₂	60.69	45.31	47.90	41.60	7.41	57.57	
Al ₂ O ₃	16.89	26.55	15.60	37.20	1.91	20.44	
Fe ₂ O ₃	9.06	12.18	3.69	3.21	0.98	7.93	
			FeO	8.41	0.30		
CaO.....	4.44	9.99	0.23	28.29	0.51	
MgO.....	1.06	0.40	8.11	0.02	18.17	1.21	
K ₂ O.....	4.25	1.10	0.23	1.08	4.91	
Na ₂ O.....	2.82	0.22	2.05	0.07	0.09	0.23	
CO ₂	41.57	0.38	
P ₂ O ₅	0.25	0.47	0.03	0.10	
Loss on ignition.....	0.62	13.75	H ₂ O	2.34	13.54	H ₂ O 0.57	6.69

¹ From Virginia, G. P. Merrill. ² Penokee district, Mich., Irving and Van Hise. ³ J. S. Diller, authority.



PLATE XXXIV, FIG. 1. — Diabase, showing boulders produced by weathering, surrounded by concentric shells of decayed rock. (T. L. Watson, photo.)



FIG. 2. — Same as Fig. 1, but showing one of the boulders in more detail. (241)

Mineral resistance. — All minerals do not show the same degree of resistance to weathering agents; therefore, other things being equal, that rock will yield most readily which contains the greater quantity of less resistant minerals. Sulphides yield more readily than carbonates, and these in turn weather more easily than silicates.

From a general study of weathering, Buckman (Ref. 2) concludes that the order of probable solubility of the following minerals when exposed under similar conditions is: Nepheline, leucite, olivine, apatite, augite, hornblende, talc, serpentine, epidote, plagioclase, orthoclase, biotite,¹ muscovite, quartz (least soluble).

As a further result of his studies, Buckman formulated what he called the *Laws of Rock Resistance*, which are as follows:

1. The more basic a rock becomes the more rapid is decomposition; and the more acid, the less rapid.
2. An increase of soda and potash accelerates chemical decomposition: (a) increase of soda over potash decreases relative resistance; (b) increase of potash over soda increases relative resistance.
3. The more magnesium and calcium present in a rock, the more rapid is chemical decomposition: (a) increase of calcium over magnesium decreases resistance; (b) increase of magnesium over calcium increases resistance.
4. Increase of iron in a rock lessens resistance.
5. Increase of aluminium checks decomposition.
6. Silica causes less rapid chemical decay.

Relation of Structure to Weathering

A dense, massive rock, even though made up of minerals of comparatively low resistance, will withstand the attack of weathering agents better than the same kind of rock traversed by fractures of different kinds. A small fissure will be easily discovered by the agents of decay, and persistent fissures may sometimes open up a pathway for the weathering agents to a considerable depth. In some mines, for example, the ore may be weathered to a depth of 500 or 600 feet at one point, and only 100 feet at another, the greater depth in the former case being due to the fact that joint planes or fault fissures formed channels of access for the surface waters.

Any weak spots in a rock weather back more readily (Plate XXX, Fig. 2). In many limestones, we find layers of siliceous or clayey impurities interbedded with the more strongly calcareous ones. When the surface waters find their way down joints, or over the surface, the more soluble layers are eaten away, while the impure ones, being less soluble, remain in relief.

In tunneling and mining, streaks of soft, weathered rock are sometimes met. These, in some cases, represent weathering of the rock

¹ There are cases where biotite seems to weather more readily than orthoclase, but on the whole it seems better to place it higher up in the series.



PLATE XXXV, Fig. 1. — Limestone "chimneys," separated by hollows caused by solution along vertical joint planes. (T. L. Watson, photo.)

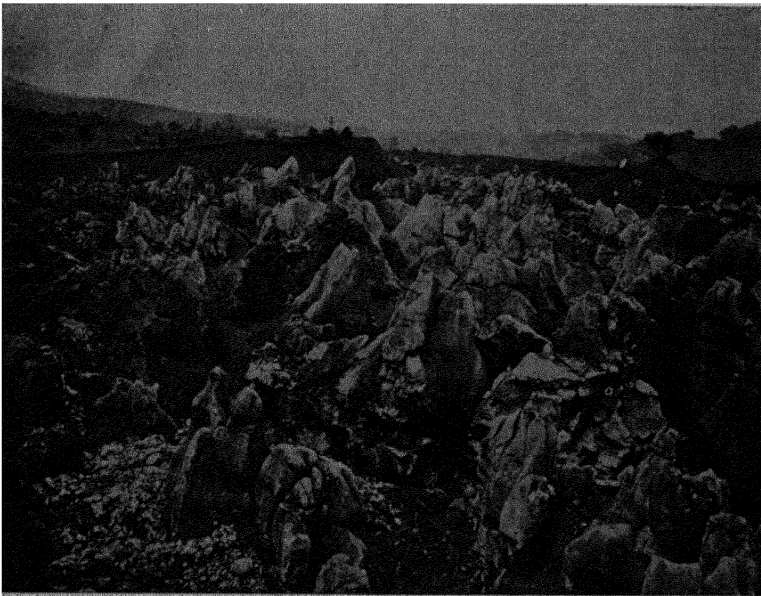

FIG. 2. — Pinnacled surface of limestone bed rock, after the residual clay has been removed. Limonite pits, Ivanhoe, Va. (H. Ries, photo.)

along some fissure, or in other instances they may be weathered dikes which have been less resistant than the wall rock (Chapter II).

On the surface the position of an ore vein, or dike, may be represented by a trench or a ridge, depending on whether it is more or less resistant than the country rock.

WEATHERING OF DIFFERENT ROCKS

Siliceous Crystalline (Igneous) Rocks

Igneous rocks like granite suffer most in the early stages of weathering from disintegration caused chiefly by changes of temperature, although granulation from disintegration is accompanied by some chemical action, especially hydration. This has ample verification in the comparison of analyses of the fresh and partially decayed rock, in the usually very small percentage of silt and clay in the partially decayed product as shown in mechanical analyses, and in slight discoloration of the decayed rock by iron oxides set free from the iron-bearing minerals through oxidation. The incipient stage of weathering of feldspathic rocks may usually be observed in exposed ledges by the whiteness and

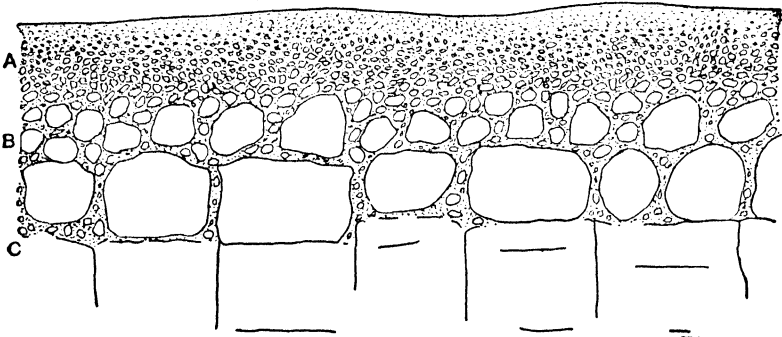

FIG. 122. — Section showing formation of residual clay from granite. (A) residual clay; (B) zone of clay and partly decayed rock fragments; (C) unweathered granite.

opacity of the feldspars, the rock having undergone kaolinization from hydration. The amount of water increases rapidly as decomposition advances.

In the more advanced stages of weathering, carbonation, oxidation, and solution promoted through atmospheric waters become dominant factors in the process. As a result of these changes, disintegration and decomposition, the rock is finally reduced to sand and clay, more or

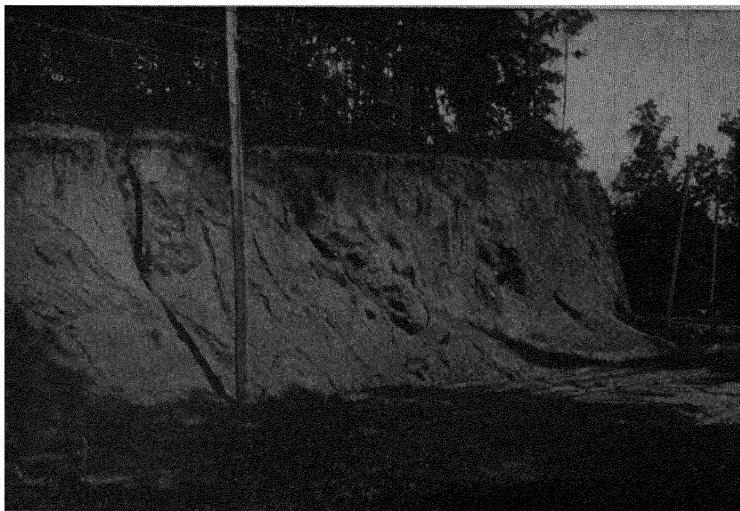

PLATE XXXVI, Fig. 1. — Residual clay derived from schist, but showing no traces of the structure of the parent rock. (T. L. Watson, photo.)

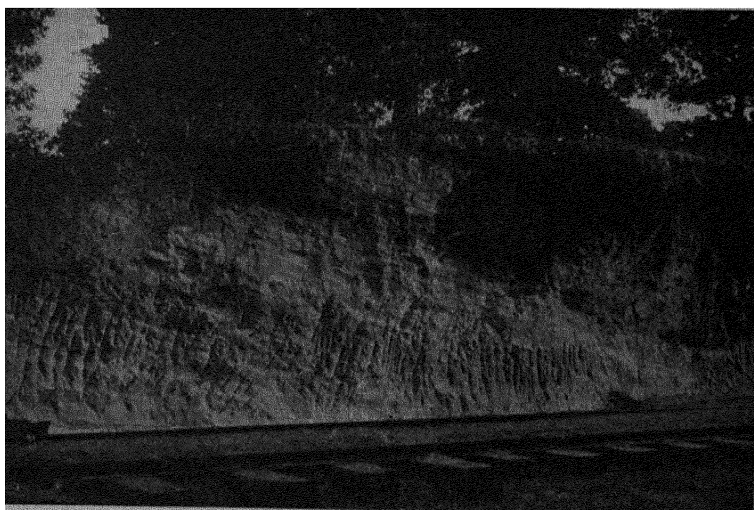

FIG. 2. — Residual clay derived from gneiss. The banded structure of the parent rock is preserved, and dips to the right. The vertical grooves are pick marks. (T. L. Watson, photo.)

less discolored by iron oxides set free through decomposition of iron-bearing minerals, such as biotite, hornblende, etc.

Unaltered, massive igneous rocks are generally traversed by joints, which are easy lines for the percolation of surface waters, that move downward along the vertical joints and laterally along the horizontal joints (Fig. 122), producing decay of the rock, extending inward from the joint surfaces.

An interesting form of weathering frequently observed in igneous rocks is illustrated in Fig. 122 and Plate XXXIV which show diabase boulders consisting peripherally of concentric shells, which break off one after another in passing from the surface toward the center. This form of weathering has resulted from the more rapid decay on the edges and corners than on the flat sides of the jointed blocks, the blocks being gradually rounded and formed into boulder-like masses of varying size. These boulder-like blocks are sometimes found on the surface, occurring singly or in groups (Plate XXXI, Fig. 2, and Plate XXXII).

In the advanced stage of weathering (decomposition) of metamorphic foliated rocks, such as gneiss and schist, the original structure of the fresh rock is frequently perfectly preserved in the decayed product (Plate XXXVI, Fig. 2).

Sedimentary Rocks

The sedimentary rocks, as explained in Chapter II, are derived from pre-existing rocks regardless of origin, and are composed therefore of their disintegrated and decomposed products which have become consolidated. It is natural therefore that such rocks should weather as a rule through changes that are more physical than chemical in nature than the igneous rocks. An exception to this statement is noted in the purely calcareous rocks. Generally speaking then we may say that with the exception of the purely calcareous rocks, sedimentary rocks, such as sandstones, shales, and argillites, weather through processes that are largely mechanical.

Sandstones.—Sandstones vary greatly not only in texture and degree of compactness, but in composition and cementing material as well. Most sandstones, however, are composed chiefly of quartz grains, one of the most resistant of minerals to chemical agents, and it suffers chiefly from mechanical breaking up. Those sandstones containing calcareous and ferruginous cements usually crumble and fall away to sand through solution of the cement (Plate XXX, Fig. 2) by atmospheric waters. On the other hand, those sandstones whose bond

is silica are exceedingly refractory to chemical agents and suffer through the effect of physical agents (disintegration, Plate XXX, Fig. 1). On account of their porosity which is sometimes appreciable sandstones often are capable of absorbing considerable, but variable, amounts of water, and in climates where freezing temperatures are reached, they may suffer greatly from frost action. "It is to their great absorption power that is due the large amount of disintegration and foliation seen in the softer sandstones, as the Triassic of the eastern United States and the sub-Carboniferous of Ohio" (Merrill.) (See further under sandstones in Chapter on Building Stone.)

Argillaceous rocks (shales and slates).— These are indurated aluminous or clay rocks, the individual particles of which are extremely small in size and have been derived from weathering of pre-existing rocks. They are, as a rule, therefore, refractory rocks to purely chemical agents, which, except in the calcareous varieties, break down from weathering largely through physical processes (Fig. 124). They yield clays chiefly from the original rock chiefly in the degree of hydration and the state of oxidation of the iron. The deep blue-black argillites of Harford County, Maryland, which, according to Merrill, contain considerable quantities of undecomposed silicates, weather, however, largely through chemical change, as shown in a percentage loss of the entire rock of 40.83 per cent through solution. He says:

"The first physical indication of decay is shown by a softening of the slate, so that it may be readily scratched by the thumb nail, and an assumption of a soapy or greasy feeling, the entire mass finally passing over to the deep red-brown unctuous clay, sufficiently rich in iron to serve as a low-grade ochre, for paints."

Calcareous rocks (limestones and dolomites).— The calcareous rocks, especially the fine crystalline or non-crystalline compact and homogeneous limestones, weather almost entirely through solution effect, for they possess a minimum capacity for absorbing water, and are, therefore, liable to little or no injury from freezing. This has ample verification in analyses of the fresh and decayed limestone, in which a total loss for the entire rock by removal of constituents in solution amounts to as much as 99 per cent. Further confirmation is shown in field study, where vertical sections of limestone and its overlying

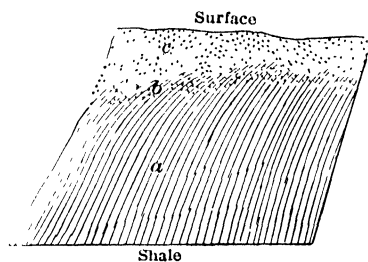

FIG. 124. — Section showing residual clay derived from shale.

mantle of residual decay are sharply defined from each other (Fig. 125). In some districts this clay contains limonite nodules, and when it is removed to obtain these, the underlying limestone exhibits a curious pinnacled surface (Plate XXXV, Fig. 2). This is readily manifested again in the gravestones made of limestone, in which the inscriptions

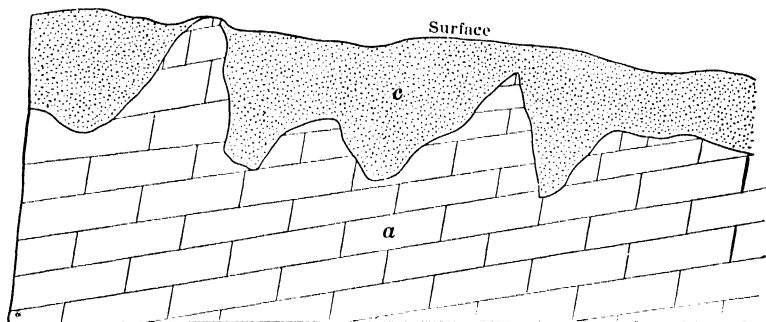

FIG. 125. — Section showing residual clay derived from limestone. Note the sharp line of contact between clay and parent rock, as well as irregular surface of latter.

are rendered illegible in many cases within a short period of years (see limestones and marbles in Chapter on Building Stone).

Calcic limestones yield more readily to the solvent effect of atmospheric waters than magnesian or dolomitic limestones, and when of coarsely crystalline texture, as in southeastern New York, the crystalline dolomite weathers through granulation, producing at the base of slopes a heap of dolomitic sand.

Gypsum. — Since gypsum forms rock masses of large size, often outcropping at the surface, its weathering qualities should be referred to. Like limestone, gypsum is soluble in surface waters, but not as readily. The weathered surface of a gypsum deposit may therefore show the same pinnacled structure and underground solution channels as are found in limestone areas.¹ If anhydrite is present, this will, under the influence of surface waters, alter to gypsum, the change being accompanied by an increase in volume. In some gypsum quarries, solution channels, filled with residual clay and surface dirt, have occasionally been mistaken for fault zones by the quarrymen.

Soils

Having discussed the weathering processes by which rocks are disintegrated and decomposed into a loose mantle of varying thickness of unconsolidated rock material, a few words may be said regarding the more important characteristics of the superficial portion of the mantle to which the name *soil* is ordinarily applied.

¹ For caves in gypsum see, for example, Okla. Geol. Survey, Bull. 11, 1913.

Definition. — The soil may be considered as the superficial, unconsolidated mantle of disintegrated and decomposed rock material, which, when acted upon by organic agencies, and mixed with varying amounts of organic matter, may furnish conditions necessary for the growth of plants (Coffey). In its broadest sense, the term soil has been used by geologists to include all of the mantle of rock decay, but by agriculturists the term is used to include the first few inches of the surface portion of the rock mantle, or the depth to which most of the small forms of vegetation have penetrated, and which passes by insensible gradation into the subsoil, which in turn merges with depth into the underlying decayed rock (in the case of residual materials).

Formation of soils. — Since soils have been formed by weathering processes the agents involved are wholly atmospheric, and, as already shown, the more soluble portions of the rock may be removed under conditions of chemical decay (decomposition) either partly or entirely in solution. The less soluble or more indestructible portions of the rock remain to form the mantle of unconsolidated rock material, the superficial portions of which may support plant life and is ordinarily mixed with a small amount of organic matter (humus). Some soils may be formed largely through the action of physical agents when little or no loss through solution may be shown.

While all soils have been derived from the disintegration and decomposition of rocks, it must be understood that not all of them have been formed from weathering of the rocks which they overlie. On the contrary, there are large areas of soils which owe their origin not to the decay of the underlying rocks, but represent the transported and deposited products of rock decay by either (1) water, (2) wind, or (3) glacial ice.

In other words the weathered rock material formed in one locality and from a given kind of rock may be removed from the place of formation and deposited in another locality of wholly different rock. As a result of transportation, the materials from many different kinds of rocks become mixed and the soils are both heterogeneous and complex as to mineral composition.

Classification of soils. — According to whether soils have been formed in place, or have been removed from their original place of formation, we may group them into (1) *sedentary* or *residual* soils, and (2) *transported* soils. These two primary groups may be further subdivided on the basis of the agencies involved in transportation or original formation. On this basis Merrill makes the following classification:

Subdivisions of the Regolith

The regolith	{	Sedentary	{	Residual deposits	Residuary gravels, sands and clays, wacke, laterite, terra rossa, etc.
			{	Cumulose deposits	Peat, muck, and swamp soils, in part.
	{	Transported	{	Colluvial deposits	Talus and cliff débris, material of avalanches.
			{	Alluvial deposits (including aqueo-glacial)	Modern alluvium, marsh and swamp (paludal) deposits, the Champlain clays, loess, and adobe in part.
			{	Aeolian deposits	Wind-blown material, sand dunes, adobe and loess, in part.
		{	Glacial deposits	Morainal material, drumlins, eskers, osars, etc.	

Sedentary soils. — These include all deposits derived by the processes of rock-weathering or from organic accumulation in place. They include (1) *residual* deposits, derived from the decay of the immediately underlying rocks; and (2) *cumulose* deposits, which have formed in place from the accumulation of organic matter

with ordinarily small amounts of rock waste, such as many of the peat and muck deposits in ponds and lakes.

Varietal names, based on the kind of rock from which they have been derived, may be given to residual soils; thus, *granite soil*, *limestone soil*, etc.

Transported soils.—These may be grouped into (1) colluvial, (2) alluvial, (3) aeolian, and (4) glacial, according to the agent involved in transportation. Colluvial deposits include the heterogeneous masses of rock waste resulting from the transporting action of gravity, such as talus, cliff, and avalanche accumulations, etc. Alluvial deposits have been formed through the agency of running water, and are usually well assorted, and therefore bedded or stratified. Aeolian deposits, as described in Chapter II, owe their origin to wind action, while the glacial deposits are the result mainly of ice action with or without that of water (Chapter X).

According to texture, soils may be divided into sand, sandy loam, loam, clay loam, and clay. A loam is usually defined as a mixture of sand and clay with some organic matter.

Composition of Soils

Soils are composed of mineral and organic matter, with usually the former predominating, although some peat and muck soils may contain as much as 75 per cent or more of organic matter. Probably the average in organic matter in most soils is less than 3 or 4 per cent.

Mineral matter.—This varies both in physical character and chemical composition. Physically the soil particles vary in size, shape, weight, and color. The chief inorganic constituents in most soils are sand, silt, and clay, although gravel and larger pieces of rock may be present. According to the U. S. Bureau of Soils, they are graded as follows: All mineral particles from 2 mm. to 0.5 mm. in diameter are classed as sands; silt includes particles within the limits of 0.05 and 0.005 mm.; and all particles less than 0.005 mm. are classed as clay. Of these clay exerts the most important influence in determining the character of the soil.

Chemically soils vary according to the kind and proportion of the various minerals of which they are composed, and they may be as variable as the rocks from which they have been derived, on which their mineralogical nature largely depends. Soils contain a great variety of minerals, probably all the common rock-forming ones in many cases, and any mineral commonly occurring in rocks may be found in soils, regardless of the origin of the particular soil. Unless the processes involved in soil formation are entirely mechanical, there is a tendency, as already explained, for the more soluble constituents of the rock to be leached out in the change to soil, which increases the relatively insoluble constituents, such as quartz. The most striking contrast between the composition of the parent rock and its derived soil is best shown in the purer limestones, which weather by solution.

Silica in the form of free quartz and various silicates, alumina as hydrous silicates, and iron as hydrated oxides, make up from 80 per cent to 90 per cent of the superficial portions of most deposits (Merrill). New minerals may be formed.

Organic matter.—The organic matter in soils consists of the remains of both plants and animals in various forms and stages of decomposition, about which very little is definitely known. Existing in the form of humus, the organic material in soils exerts an important influence upon the growth of plants. Muck and peat, marsh and swamp, and meadow types of soils are characterized by unusually large percentages of organic matter.

Soil Areas¹

For the purposes of soil classification the U. S. Bureau of Soils divides the United States into thirteen subdivisions, seven of which, lying east of the Great Plains, are called *soil provinces*, and six, including the Great Plains and the country to the west,

¹ Summarized from Bull. No. 96, U. S. Bureau of Soils, 1913.

are known as *soil regions*. A soil province is defined as an area having the same general physiographic expression, the soils in which have been produced by the same forces, and throughout which each rock or soil material yields to equal forces equal results. A soil region is more inclusive, and embraces an area the parts of which may on further study resolve themselves into soil provinces. Soil provinces and soil regions are essentially geographic features. They are differentiated on the basis of geographic features rather than on soil character.

The soils occurring in a province are grouped on the basis of certain characteristics of the soils themselves, each group constituting a *soil series*. A soil series is defined as a group of soils having the same range in color, the same character of subsoil, particularly as regards color and structure, broadly the same type of relief and drainage, and a common or similar origin. A soil class includes all soils having the same texture, such as sands, clays, loams, etc. A soil class is not limited in its occurrence to a soil province, but the same class occurs in all the provinces or regions.

The soil unit or the soil individual is the soil type; that is, a soil which throughout the area of its occurrence has the same texture, color, structure, character of subsoil, general topography, process of derivation, and usually derivation from the same material.

The soil province is named in accordance with some generally accepted terminology for the area represented or according to the process by which its soil material was formed. A soil series is named from some town, village, county, or natural feature existing in the area when it was first encountered. The class name is wholly descriptive.

Taking the soils as a whole, so far as they have been classified into types, the dominant soils of the United States are the silt loams, with the other classes following in this order: Loams, fine sandy loams, clay loams, sandy loams, clays, sands, and fine sands.

List of References on Rock-Weathering and Soils

1. Buckley, E. R., The Properties of Building Stones and the Methods of Determining their Value, Jour. Geol., 1900, Vol. VIII, pp. 160-185, 333-358, 526-567.
2. Buckman, H. O., Chemical and Physical Processes involved in Formation of Residual Clay, Trans. Amer. Ceramic Society, XIII, p. 336, 1911.
3. Hilgard, E. W., Soils, The Macmillan Company, N. Y., 1907, 593 pages.
4. Merrill, G. P., The Physical, Chemical, and Economic Properties of Building Stones, Maryland Geol. Survey, 1898, Vol. II, pp. 47-123.
5. Merrill, G. P., Stones for Building and Decoration, John Wiley & Sons, N. Y., 1903, 3d edition, 551 pages.
6. Merrill, G. P., Rocks, Rock-Weathering, and Soils, The Macmillan Co., N. Y., 1906, 400 pages.
7. Van Hise, C. R., A Treatise on Metamorphism, Mon. XLVII, U. S. Geol. Survey, 1904, 1286 pages.
8. Watson, T. L., Ga. Geol. Surv., Bull. 9-A, 1902, and Geol. Soc. Amer., Bull. XII: 93, 1901.
9. Emerson-Smith, Agricultural Geology, New York, 1928. Wiley & Sons.

For soils, see the publications of the Bureau of Soils, U. S. Dept. of Agriculture, Washington, D. C., and of the various State Agricultural Experiment Stations.

CHAPTER V

SURFACE WATERS (RIVERS)

Introduction. — The engineer in many branches of his work is brought face to face with the work of rivers past or present, and consequently needs to be familiar not only with many phases of the work of running water, but especially with the deposits that have been built up by streams. The living streams are related not alone to one kind of engineering work, but to many.

River improvement, surface water supply, hydro-electric power plants, railroad construction, and irrigation are all connected with or affected by the surface flow of water as will be presently explained.

Stating the case in general, by way of introduction we may say that a part of the rain water which falls on the surface gathers together to form streams, often of navigable size. These streams which are of varying volume, velocity and size are active agents of erosion; they carry away more or less of the eroded material, and deposit it again under favorable conditions.

To discuss in a bald and theoretic manner the way in which they perform their work may be of scientific interest, but unless we couple with this a statement of its bearing on engineering work, the discussion loses much of its practical significance.

STREAM FLOW

Rainfall and run-off. — The amount of rain which normally falls in any given region varies in different parts of the country, as explained in Chapter VI, and only a portion of it runs off on the surface either directly or indirectly, the balance being disposed of partly by evaporation and partly by seepage into the ground (see further in Chapter VI).

That portion which flows off the surface of the land in the form of visible streams is known as the *run-off*.

Factors controlling run-off. — The amount of run-off is affected by: (1) Amount and intensity of precipitation; (2) slope; (3) character and condition of soil; (4) vegetation; and (5) wind. The effects of these factors are as follows:

1. A heavy shower may give an abundant run-off, but a light one

may be absorbed to a considerable extent by the soil, before much run-off takes place. The run-off will also be greater during a steady rain, because in such event the soil, unless very dry and porous, becomes so saturated that it cannot absorb any more water, and the entire precipitation finds its way to the streams. So too, if a given quantity of rain falls in a short time, more of it will run off, than if the same amount were precipitated slowly, and the soil had a better chance to absorb it. A frozen soil may cause similar results. Again, if a warm rain falls on snow, the latter not only prevents its filtering into the soil, but the melting of the snow adds to the volume of the streams. The reverse, however, is sometimes found to occur, as when a heavy snow fall absorbs the rain, and lets it drain off gradually. Melting snows are said to rarely affect large streams, but the same is not true of smaller ones, especially in hilly or mountainous regions.

2. Water will drain off more rapidly on a steep slope than on a gentle one. Newell states that a rainfall giving as high as 30 to 40 per cent run-off on the steep sides of a mountain range may not produce more than 3 or 4 per cent on the lower levels or gently rolling plains.

3. Porous soils absorb more rain than dense ones, but even a porous one which is water soaked or frozen will permit rapid surface drainage.

4. Vegetation, especially forest growth, is a strong deterrent of the surface drainage, and exerts a beneficial effect, because it retains the moisture and feeds it more slowly to the streams.¹ Where forests have been removed from the watershed of a river, or the vegetation destroyed in other ways, the rainfall drains off rapidly, and the stream may be subject to great fluctuation.

5. Much of the water which remains on the surface escapes by evaporation, but the rate of this is influenced by several factors such as the dryness of the atmosphere, temperature, and vegetation.

Ratio of run-off to rainfall. — For many purposes, irrigation in particular, it is desirable to know the ratio of run-off to rainfall, but unfortunately no rule can be made to apply to all parts of the country.

On some watersheds² of the eastern and more humid regions of the United States, having a rainfall which is relatively constant in quantity and time, there appears to be a somewhat consistent ratio between rainfall and run-off. But in the arid west no such constant ratio appears to exist.

¹ Chittenden, H. H., Relation of forests to stream flow. Trans. Amer. Soc. Civ. Engrs., 1908, and Eng. News, Oct., 1908.

² A *watershed* of a stream includes all the area whose drainage runs into that stream.

Run-off from different watersheds. — The table given below¹ gives the run-off from a number of different watersheds.

MEAN ANNUAL RUN-OFF FOR VARIOUS WATERSHEDS IN THE UNITED STATES

River.	Point of Measurement.	Drainage area, square miles.	Period.	Run-off in depth in inches on drainage area.
Kern.....	Bakersfield, Cal.....	2,340	1896-1905	4.36
San Joaquin.....	Herndon, Cal.....	1,640	1896-1901	20.47
Kings.....	Sanger, Cal.....	1,740	1897-1906	20.38
Sacramento.....	Red Bluff, Cal.....	4,300	1902-1906	24.06
Umatilla.....	Umatilla, Ore.....	2,130	Nov. 1, 1900, to Dec. 31, 1900	3.94
Willamette.....	Albany, Ore.....	4,860	Jan. 1, 1899, to Dec. 31, 1908	46.62
Boise.....	Boise, Idaho.....	2,610	1895-1904	15.60
Green.....	Green River, Wyo.....	7,450	May 1, 1896, to Oct., 31, 1906	4.81
Laramie.....	Uva, Wyo.....	3,180	May, 1895, to Oct., 1903	1.10
Red.....	Grand Forks, N. Dak..	25,100	Sept., 1902, to Sept., 1908	2.08
Rio Grande.....	Rio Grande, N. Mex..	14,000	Jan. 1, 1896, to Dec. 31, 1905	1.46
Animas.....	Durango, Colo.....	812	July, 1895, to Dec., 1905	14.86
South Platte.....	Denver, Colo.....	3,840	Jan. 1, 1896, to Nov. 30, 1906	1.44
Green.....	Greenriver, Utah.....	38,200	Jan., 1895, to Dec., 1908	3.17
Logan.....	Logan, Utah.....	218	1896-1900 1904-1906	21.18
Carson.....	Empire, Nev.....	988	Nov., 1900, to Dec., 1906	6.25
Truckee.....	Vista, Nev.....	1,520	Sept., 1899, to Dec., 1906	9.18
Humbolt.....	Orleans, Nev.....	13,800	Jan., 1897, to Dec., 1906	0.25

¹ Compiled by Newell and Murphy, Irrigation Engineering, from U. S. Geol. Survey records.

MEAN ANNUAL RUN-OFF FOR VARIOUS WATERSHEDS IN THE UNITED STATES
—(Continued)

River.	Point of Measurement.	Drainage area, square miles.	Period.	Run-off in depth in inches on drainage area.
Colorado.....	Yuma, Ariz.....	225,000	Jan., 1902, to Dec., 1906	1.15
St. Croix.....	St. Croix Falls, Wis..	6,370	1902-1904	10.60
Menominee.....	Iron Mountain, Mich..	2,420	Sept., 1902, to Sept., 1906	18.92
Illinois.....	Peoria, Ill.....	13,200	Apr. 1, 1903, to Jan. 30, 1906	14.11
Maumee.....	Waterville, Ohio.....	6,110	Dec., 1898, to Jan., 1902	13.61
Scioto.....	Columbus, Ohio.....	1,050	1889 to July, 1906	10.43
Duck.....	Columbia, Tenn.....	1,260	Nov. 1, 1904, to Dec. 31, 1908	18.87
Tennessee.....	Chattanooga, Tenn. .	21,400	1899-1908	23.63
Tombigbee.....	Columbus, Miss.....	4,440	1905-1908	15.48
Black Warrior...	Cordova, Ala.....	1,900	1900-1908	19.37
Alabama.....	Selma, Ala.....	15,400	1900-1908	24.01
Savannah.....	Augusta, Ga.....	7,300	1899-1908	22.29
Catawba.....	Rock Hill, S. C.	2,990	1895-1903	25.21
Tar.....	Tarboro, N. C.....	2,290	1896-1900	13.89
Roanoke.....	Randolph, Va.....	3,080	1901-1905	18.86
Potomac.....	Pt. of Rocks, Va.....	9,650	1895-1906	14.40
Oswego.....	Oswego, N. Y.	5,000	1897-1901	11.69
Delaware.....	Port Jervis, N. Y.....	3,250	1904-1908	22.20
Susquehanna.....	Binghamton, N. Y.....	2,400	1901-1906	28.88
Hudson.....	Mechanicsville, N. Y. .	4,500	1891-1900	22.95
Mohawk.....	Dunsbach Ferry, N. Y.	3,440	1898-1907	23.28

DISCHARGE OF VARIOUS RIVERS

River.	Discharge in Cubic Feet per Second.			Ratio of Minimum to Maximum.	Extreme Range between High and Low Water.	Remarks.	
	Minimum.	Maximum.	Annual Mean.				
Columbia.....	48,500	1,390,000	67,000	1 to 28.7	Measured at Dalles.	
Mississippi at St. Paul.....	1,500	117,000	1 to 23.4	19.7		
Mississippi at St. Louis.....	30,000	1,200,000	225,000	1 to 40.0	42.5		
Mississippi at Cairo.....	45,000	1,507,000	1 to 33.5	54.0		
Mississippi at Vicksburg.....	1,617,000	52.5		
Mississippi at New Orleans.....	65,000	1,740,000	1 to 26.8	21.4		
Missouri at Sioux City.....	7,000	650,000	1 to 92.8	19.0		
Missouri at mouth.....	15,000	900,000	100,000	1 to 60.0	35.0		
Niagara.....	175,000	280,000	219,850	1 to 1.49		
Ohio at Pittsburgh.....	1,400	439,000	1 to 313.5	35.6		
Ohio, just below Kanawha River.....	5,600	63.5		
Ohio, just below Kentucky River.....	6,900	59.4		
Rio Grande at El Paso.....	16,600	1,500		In dry seasons flow all subsurface.
St. Lawrence.....	185,000	330,000	251,900	1 to 1.78		
Tennessee at Chattanooga.....	3,700	468,000	1 to 126	58.6		

In comparing the run-offs from different watersheds, all the influencing factors must be considered, otherwise serious errors may result. If deductions are to be made from such comparisons, it is important not only to compare areas containing similar conditions, but having approximately the same size. Such deductions can not take the place of direct measurements.

Stream formation. — As the rain falls on the surface, that portion which runs off, becomes rapidly concentrated along definite lines due to inequalities of the surface, thus developing a series of rivulets, which in turn converge to form brooks, and these to form large streams or rivers. The total quantity of water conveyed to the sea being very large, it is estimated¹ that rivers carry about 6500 cubic miles of water to the ocean annually.

This is conveyed by rivers of varying size and length. Some are mere brooks, others are mighty streams, occasionally flowing along with irresistible force. They are not only more numerous in regions of abundant rainfall, but have a larger number of branches.

Those which flow throughout the year are known as *permanent* streams, while those which flow during but a part of the year are *temporary* or *intermittent streams*, and many of those in arid regions are of the latter class. Streams become permanent for all parts of their courses sunk below the level of the upper surface of groundwater, when they are independent of the run-off of showers (see further under Chapter VI). Each stream performs similar work, but that done by it differs in degree and constancy.

¹ Chamberlin and Salisbury, *Geology*, I.

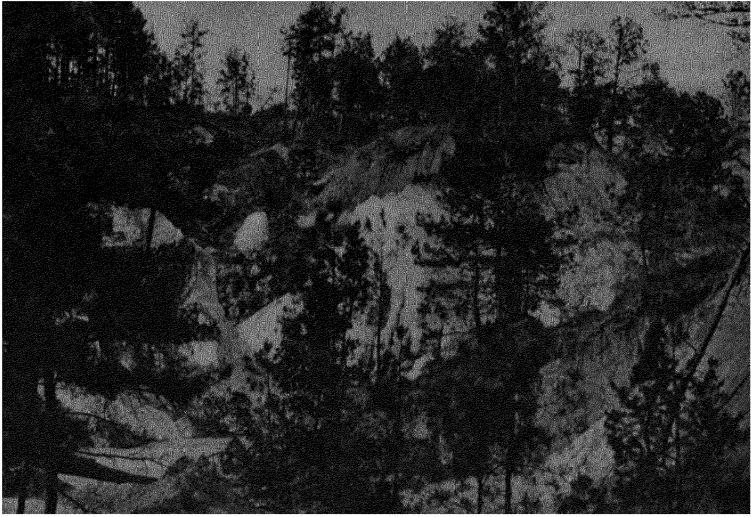

PLATE XXXVII, FIG. 1. — Hillside gullied by erosion, Lyell gullies, near Milledgeville, Ga. (T. L. Watson, photo.)



FIG. 2. — Gravelly character of material carried by swiftly flowing stream. (T. L. Watson, photo.)

The water which is held by the soil and slowly drained into the streams is of great benefit to navigation, since it keeps up the supply, at a time when there may be little or no surface run-off. One large river with its tributaries may therefore drain a very large area, which is called its *basin*.

Some rivers show great irregularity of flow, having a large volume during spring and early summer, and running almost dry in autumn. But, whatever the size of a river, its behavior is governed by certain laws, so that either a large or a small stream may exhibit the same sinuosities, bars, eddies, or floods.

In the case of navigable rivers, it is necessary to maintain a free, unobstructed channel, and since much of the work done by the current of a stream is injurious to the permanence of such conditions, it is of the highest importance for an engineer engaged in river improvement to understand the nature of the work performed by river currents, so that if necessary he can control and regulate it. Indeed, the work of river improvement is one of the most important branches of civil engineering.

In studying a river with the view to improving it for navigation, or using it for water power, irrigation, or water supply, the collection of data regarding rainfall, Plate XXXVIII, Figs. 1 to 4 are of interest in that they show the difference in behavior of typical rivers of the eastern humid region of the United States and the western arid portion. The height of the black lines illustrates the relative quantity of water expressed in cubic feet per second, or *second feet*, occurring throughout the year.

The diagram shows that the greater flow of the Susquehanna River at Harrisburg, Pa., occurs in the spring, followed by a summer drought, especially in late August or early September. On the Yadkin River at Salisbury, N. C., on the contrary, the greatest flow is due to short quick floods in late summer and early autumn, and came probably from heavy storms on the mountains.

Interesting comparison is afforded by the diagram of the Gila River at Buttes, Ariz., which shows a relatively small steady flow in the early part of the year, followed by erratic floods due to cloudbursts on the drainage basin. Strongly contrasted with this is the large and comparatively uniform flood in the Green River at Blake, Ariz., which is typical of streams coming from the snow-clad mountains, whose melting snows supply water as the summer heat melts them.¹

Measurement of water.— This may be done with two different objects in view: (1) measurement of supply, and (2) measurement of duty requirement.

“Measurement of supply is for the purpose of determining the quantity of water available for irrigation, power development and domestic use. It includes the measurement of run-off from the various streams and to a limited degree also the determination of underground flow

¹ Newell and Murphy, *Principles of Irrigation Engineering*, 1913.

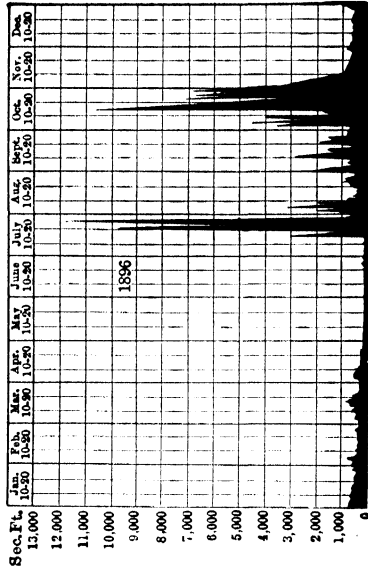
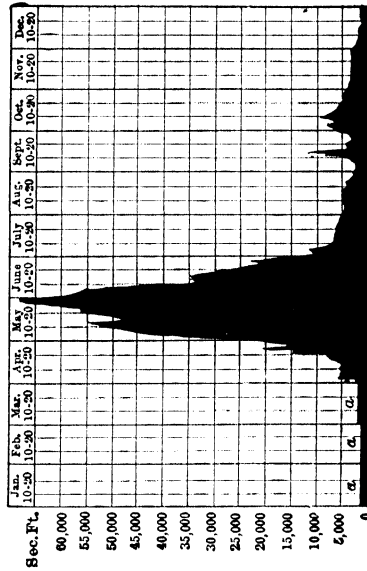

FIG. 3.



a Approximate

FIG. 4.

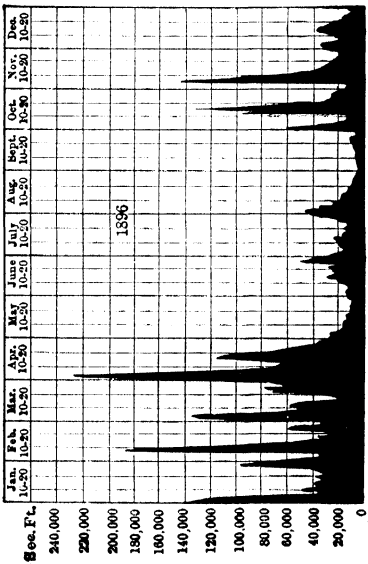

FIG. 1.

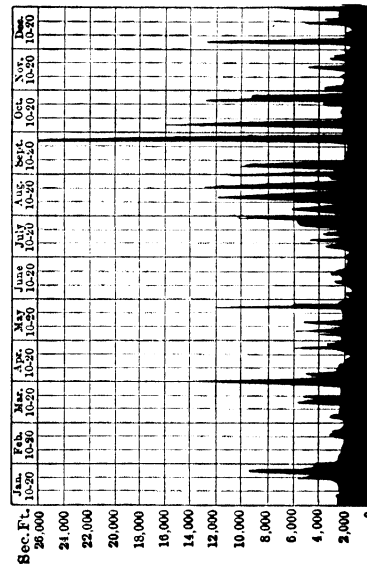

FIG. 2.

PLATE XXXVIII, Diagrams showing volume of discharge: FIG. 1. — Susquehanna River, Harrisburg, Pa., 1896. FIG. 2. — Yadkin River, Salisbury, N. C., 1898. FIG. 3. — Gila River, Buttes, Ariz. FIG. 4. — Green River, Blake, Utah, 1897. (After Newell and Murphy, Irrigation Engineering.)

which may be made available for use through pumping or artesian flow. Measurement of duty requirement includes the determination of the amount used for irrigation, power development and other purposes. Both of the above classes of measurements are necessary in an enterprise involving the use of water; the first to determine the amount available and the second to determine the extent of an enterprise which a given supply will furnish." (Newell and Murphy.)

Stream measurement. — This is accomplished by measuring the total quantity of water passing a given point in a stream, and from this determining the run-off from the watershed.

Unit of measurement. — The two classes used represent quantity and rate of flow respectively. Units of quantity are the gallon, cubic foot and acre foot. The first two may be employed to express the quantity of water stored or used for domestic purposes, but the last is more commonly used in engineering estimates of irrigation work. The *acre foot* is the amount of water required to cover 1 acre, 1 foot deep, and is equal to 43,560 cubic feet.

The rate of flow is the quantity of water flowing through a pipe or channel in a given unit of time, usually a second. The *miner's inch* and the *second foot* are the common units. A *miner's inch* represents the quantity of water which flows through an opening 1 inch square under a given head, usually 4 inches. A *second foot* can be defined as the delivery of 1 cubic foot per second of time. This is a more definite unit of measurement than the miner's inch.

Second feet per square mile is the average number of cubic feet of water flowing per second from each square mile of area drained, it being assumed that the run-off is evenly distributed.

Run-off in inches is the depth to which the drainage area would be covered if all the water flowing from it in a given period were conserved and uniformly distributed over the surface.

Convenient equivalents. — The following is a list of convenient equivalents for use in hydraulic computations:

- 1 second-foot equals 7.48 United States gallons per second; equals 448.8 gallons per minute; equals 646,272 gallons for one day.
- 1 second-foot equals 6.23 British imperial gallons per second.
- 1 second-foot for one year covers 1 square mile 1.131 feet or 13.572 inches deep.
- 1 second-foot for one year equals 31,536,000 cubic feet.
- 1 second-foot equals about 1 acre-inch per hour.
- 1 second-foot for one day covers 1 square mile 0.03719 inch deep.
- 1 second-foot for one 30-day month covers 1 square mile 1.116 inches deep.
- 1 second-foot for one day equals 1.983 acre-feet.
- 1 second-foot for one 30-day month equals 59.50 acre-feet.
- 100 United States gallons per minute equals 0.223 second-foot.
- 100 United States gallons per minute for one day equals 0.442 acre-foot.

- 1,000,000 United States gallons per day equals 1.55 second-feet.
 1,000,000 United States gallons equals 3.07 acre-feet.
 1,000,000 cubic feet equals 22.95 acre-feet.
 1 acre-foot equals 325,850 gallons.
 1 inch deep on 1 square mile equals 2,323,200 cubic feet.
 1 inch deep on 1 square mile equals 0.0737 second-foot per year.
 1 foot equals 0.3048 meter.
 1 mile equals 1.60935 kilometers.
 1 acre equals 0.4047 hectare.
 1 acre equals 43,560 square feet.
 1 acre equals 209 feet square, nearly.
 1 square mile equals 2.59 square kilometers.
 1 cubic foot equals 0.0283 cubic meter.
 1 cubic foot equals 7.48 gallons.
 1 cubic foot of water weighs 62.5 pounds.
 1 cubic meter per minute equals 0.5886 second-foot.
 1 horse-power equals 550 foot-pounds per second.
 1 horse-power equals 76 kilogram-meters per second.
 1 horse-power equals 746 watts.
 1 horse-power equals 1 second-foot falling 8.80 feet.
 1½ horse-power equals about 1 kilowatt.

To calculate water-power quickly: $\frac{\text{Sec.-ft.} \times \text{fall in feet}}{11} = \text{net horse-power on}$
 water wheel realizing 80 per cent of theoretical power.

WORK PERFORMED BY RIVERS AND ITS ECONOMIC APPLICATION

The work performed by rivers is of three kinds, as follows:

1. *Work of erosion*, which is mainly of a mechanical nature, but in part is chemical. Through it the river carves its channel of variable size in either hard or soft rocks. The process is usually slow, except in soft materials, when under favorable conditions the process may be rapid and destructive.
2. *Transportation*, by means of which the stream removes more or less effectively the material derived from erosion, and the material supplied to it in other ways.
3. *Deposition*, or the dropping of the material which it has carried in variable quantity for different distances.

One problem of the engineer who has to deal with the work of running water is to see that the river performs these several functions at the proper time and in the proper place. The discussion of the latter will be kept separate so far as is possible, although this cannot always be done.

Work of Erosion

Erosion. — The work of erosion performed by rivers may be mechanical (*corrasion*), and chemical (*corrosion*). Both may be going on at the same time, but the former is usually the more important of the two.

Corrasion. — Water free from sediment does but little erosive work, unless it is flowing swiftly over unconsolidated material like sand, or loose soil, but when running over hard rock, even though its velocity is high, the water alone has little wearing effect.

A heavy rainstorm falling on the soil of a hillside will sometimes wash out a large gully in a short time¹ (Plate XXXVII, Fig. 1), and neglect to prevent or stop this results in the removal of much material from the surface in some areas, and deterioration in land values (Refs. 4 and 6). In all cases the damage is serious whether it involves the erosion of farm lands or railway embankments. Earth dams built of residual clay (*q.v.*) are also liable to injury from this cause.

In contrast to this we have the case of the swift, but sediment-free Niagara River flowing over hard lichen-covered rocks, and yet not having enough erosive power to remove the green vegetable growth.

The corrasive work of a stream is performed chiefly with the aid of the sediment which it carries. This consists of mineral matter ranging all the way from fine clay to coarse stones in different streams, the grains acting like cutting tools. A sluggish stream carries only fine sediment, while a mountain torrent carries or rolls along stones of large size (Plate XXXVII, Fig. 2).

It can be easily seen that the amount of mechanical wear which a stream accomplishes depends on the character of the rock, stream velocity, and load of sediment. Both the sediment carried in suspension and that rolled along the bottom will wear the stream channel. A swift sediment-laden stream cuts its channel with comparative rapidity, but at a different rate in different kinds of rock, and assuming the sides and bottom of the channel to be of equal resistance does its main work of cutting, vertically. A slow stream cuts more actively laterally, and does not deepen its valley much. As a result of this the sluggish stream is likely to develop flats.

Corrosion. — The work of solution or corrosion performed by a river is usually of secondary importance, except in limestone areas. All river waters contain dissolved mineral matter, but it is probable that most of this is contributed to the river by underground waters. Some mineral matter, however, is dissolved from the sides and bottom of the river channel, especially where the latter is of soluble rock like limestone, and the water is somewhat acid in character.

Factors governing rate of erosion. — The main factors affecting the erosive power of a river are slope, character and structure of rock, and climate.

¹ See Keyes, *Science*, Feb. 22, 1918; also Smith, W. D., *Tropical Geology and Engineering*, *Philippine Jour. Sci.*, XVIII, No. 3, March, 1921.

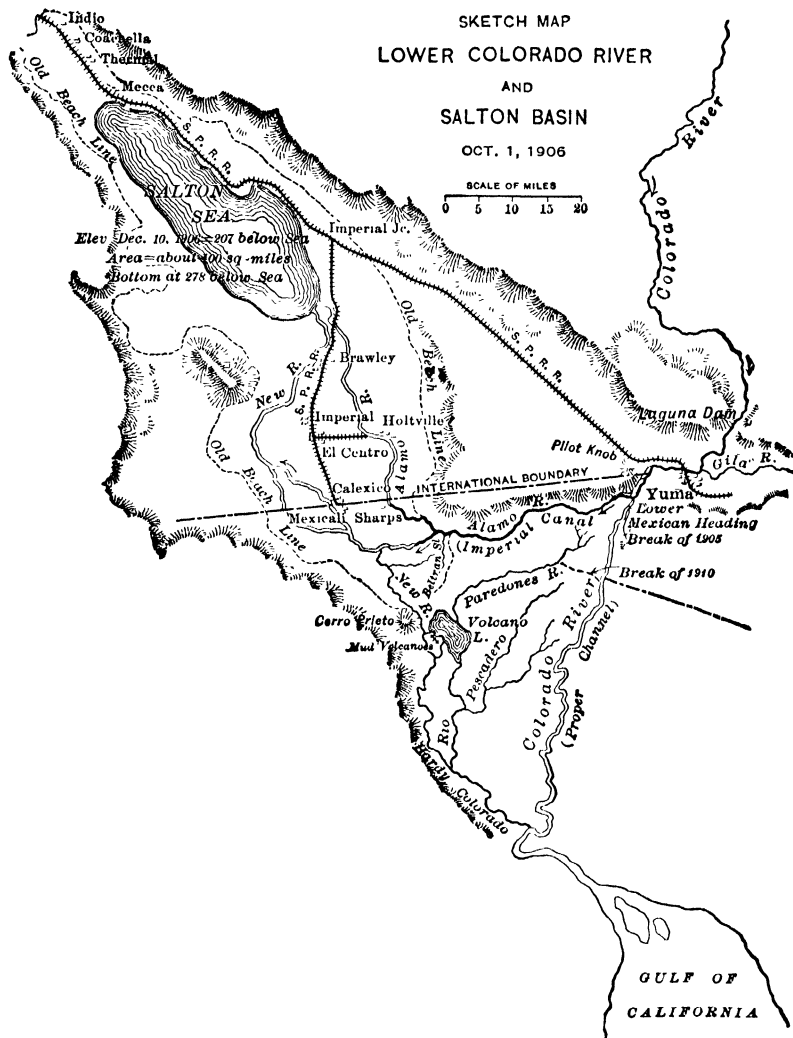

FIG. 126. — Map of Salton Sink and Imperial Valley, California. Shows points at which river broke through its banks. (From Thomas and Watt, Improvement of Rivers.)

The steeper the grade, the higher the velocity, and the greater the transporting power of the river; hence, other things being equal, the larger the amount of erosion it is capable of accomplishing.

Hard and firm rocks resist erosion more than loose and unconsolidated ones. Some years ago when the Colorado River broke through its banks and flowed down into the Imperial Valley (Fig. 126), the

rapidity and depth of erosion accomplished by the New River flowing over sandy beds was astonishing. "Near the town of Imperial early in 1906, the river was flowing in a shallow depression, but by August a chasm had been cut there to a depth of 80 feet and with a width of 1200 feet" (Thomas and Watt).¹

But even very hard rock may be worn with comparative rapidity if it is traversed by a swift stream transporting resistant and sharp angular grains. Cases of this are frequently seen in sluiceways lined with vitrified brick, and used for carrying off sand, ore tailings, or granulated slag.

Stratified rocks, especially thinly-bedded ones, and much-jointed rocks, are more easily eroded than massive ones, and if the beds are tilted they succumb more readily than if they are horizontal.

In dealing with the improvement and regulation of navigable rivers the engineer is concerned with the erosion of soft rather than with hard material, and frequently has to guard against strong scouring action of streams during flood periods. One case illustrative of this, was that of a bridge constructed across the Saskatchewan River in Canada. Fifty-foot piles were driven into the sandy bottom of the river to serve as supports for the piers. Shortly after their completion the June floods scoured out the bottom to such an extent that the piles were carried away. They were replaced by eighty-foot piles, the river bottom covered with matting, on which was dumped riprap, and then they remained.

Depth of erosion. — A stream at first cuts vertically, that is downward, and if no other natural agents, such as weathering, were cooperating with it, the valley would in the beginning have vertical walls, with the stream completely covering the bottom of the valley.

Cutting thus downward, a stream will tend to erode its valley until it reaches sea-level, or the level of some other body of water into which it flows. This lowest sea level to which running water will usually wear a land surface is known as the *base level*. Some large rivers, like the Mississippi, carve their channels somewhat lower than sea level. A *temporary* base level is established in those streams emptying into inland bodies of water (lakes) which are elevated above sea level. From what has just been said, it must not be understood that the entire length of the stream reaches base level at the same time, since for a long period, only the lower part of its grade may be cut down to this plane. On the contrary, the profile of a stream which has reached base level in the lower portion of its course, is that of a parabolic curve.

The head of the valley gradually works inland, and continues to

¹ See also Cory, H. T., *The Imperial Valley and Salton Sink, San Francisco, 1915.*

grow by headward erosion until it reaches a point "where erosion towards the valley in question is equal to erosion in the opposite direction." (Chamberlin and Salisbury.) But while the stream is deepening its valley, the latter is also being widened at a variable rate by weathering and side wash. Particles of soil and rock are dislodged from the valley sides by the weathering agents, and carried down into the stream either by gravity or rain wash. Some of the material may be fine enough to be removed at once by the stream, but other portions may not be carried away until a flood comes.

After a stream has reached its base level, it begins to cut laterally, thereby broadening its valley, and in the valley thus broadened the stream *meanders* or swings from side to side (Plate XXXIX, Fig. 1).

Where several streams have cut down to base level, and begun to meander, the divides separating their valleys are gradually worn away, and the land surface reduced to an almost featureless plain, at or near sea level, known as a *penplain* (see further, p. 288).

Character of meandering streams.—Meandering streams usually have a low velocity, and are easily deflected, so that if the bank is more easily eroded at one point than at another, it is sure to be cut into. If now the stream is directed against one point in the bank, it cuts in there, and the current, striking this bank obliquely, is deflected toward the opposite bank, and develops a curve there (Plate XL). This action, once started, continues, resulting in the concave bank being eroded more and more and the curves or meanders becoming continually more accentuated.

There is also a marked difference in the velocity of the current along the two banks of the bend. Thus it may be 5 feet per second close to the concave shore and only 1 foot per second on the convex one. This will naturally result in the dropping of sediment on the convex side, and crowding the current farther towards the concave shore (Plate XXXIX, Fig. 2).

As the result of such shifting of the Mississippi River at Memphis, in a period of fifteen years, the left bank had increased its area 106 acres, with a maximum increase in width of 2300 feet, and parts of the former channel silted up 45 feet in one year. The change of the flow necessitated protection of the right bank for some distance.



FIG. 127. — River curve indicating place of greatest erosion, on bend. (Thomas and Watt.)

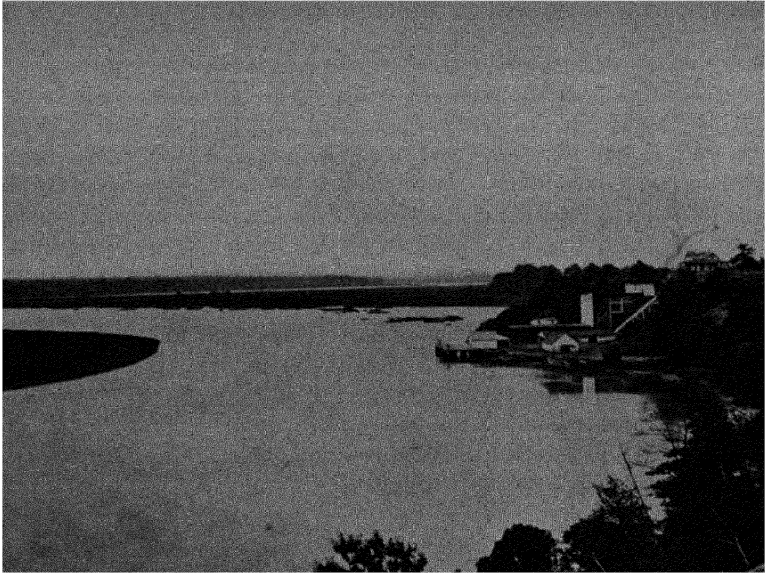

PLATE XXXIX, FIG. 1. — Patuxent River, Maryland. A river flowing nearly at base level. Note the sediment depositing on convex side of bends and supporting marsh growth. (H. Ries, photo.)

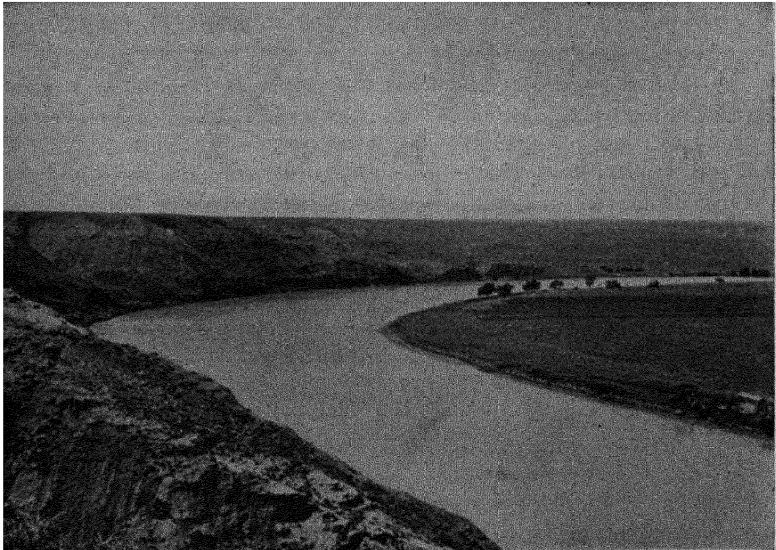

FIG. 2. — Saskatchewan River, near Medicine Hat, Alberta. On concave side of curve, river has undermined cliffs, while on convex side, deposition has taken place. (H. Ries, photo.)

The extreme curvatures of river channels thus developed are termed *ox-bows* (Plate XL). When portions of adjoining curves almost touch, the river may become straightened by artificial or natural means, and a *cut-off* be formed (Plate XL). The former consists in excavating a channel to connect neighboring parts of adjoining ox-bows, as in the case of the Dutch Gap on James River, below Richmond, Va. The latter may be accomplished in two ways: (1) Either by extreme development of the curves the strip of land between two adjoining ones may become so thin as to break through, or (2) during periods of flood, when the river covers most of the flood plain, the main current, in preference to following the regular channel, may flow across the neck of land (Plate XL), and cut a new channel, which the river will then follow during normal periods. If the abandoned channel curve becomes separated from the main stream by sediment, and contains stagnant water it is called an *ox-bow* lake (Plate XL). Such lakes are common along the middle and lower courses of the Mississippi River.

Shoals, bends, and crossings. — To the engineer the behavior of rivers flowing on an alluvial plain is a matter of some importance, especially if he is engaged in their regulation and improvement. From his viewpoint the river often consists of a series of bends, connected by straight reaches. The main current or volume of flow follows the concave shore, until a straight part of the channel is reached, when it crosses over gradually to the beginning of the next bend. This is known as a *crossing* (Plate XL). Deep water is found along the concave bank, the deepest spot being usually below the point of sharpest curvature. On approaching the crossing, the flow spreads out, and as there is here a wider cross section as well as an absence of eddies the sediment settles.

The wider the channel the greater the slackening, and the larger the amount of sediment deposited. Crossings therefore are found at low water to be shallow and of uncertain depths. In their widest parts the sediment may build up into bars or islands. Occasionally the straight reaches of a river being narrow, keep free from sediment, as the volume of water scours them, so that they retain their same cross section from year to year.

Scour. — During flood periods much sediment is dropped in the crossings, and when the river falls again to a low stage it makes an effort to remove it. It can do this, however, but incompletely, since a higher velocity is required to pick the particle of sediment up than is necessary to transport it.

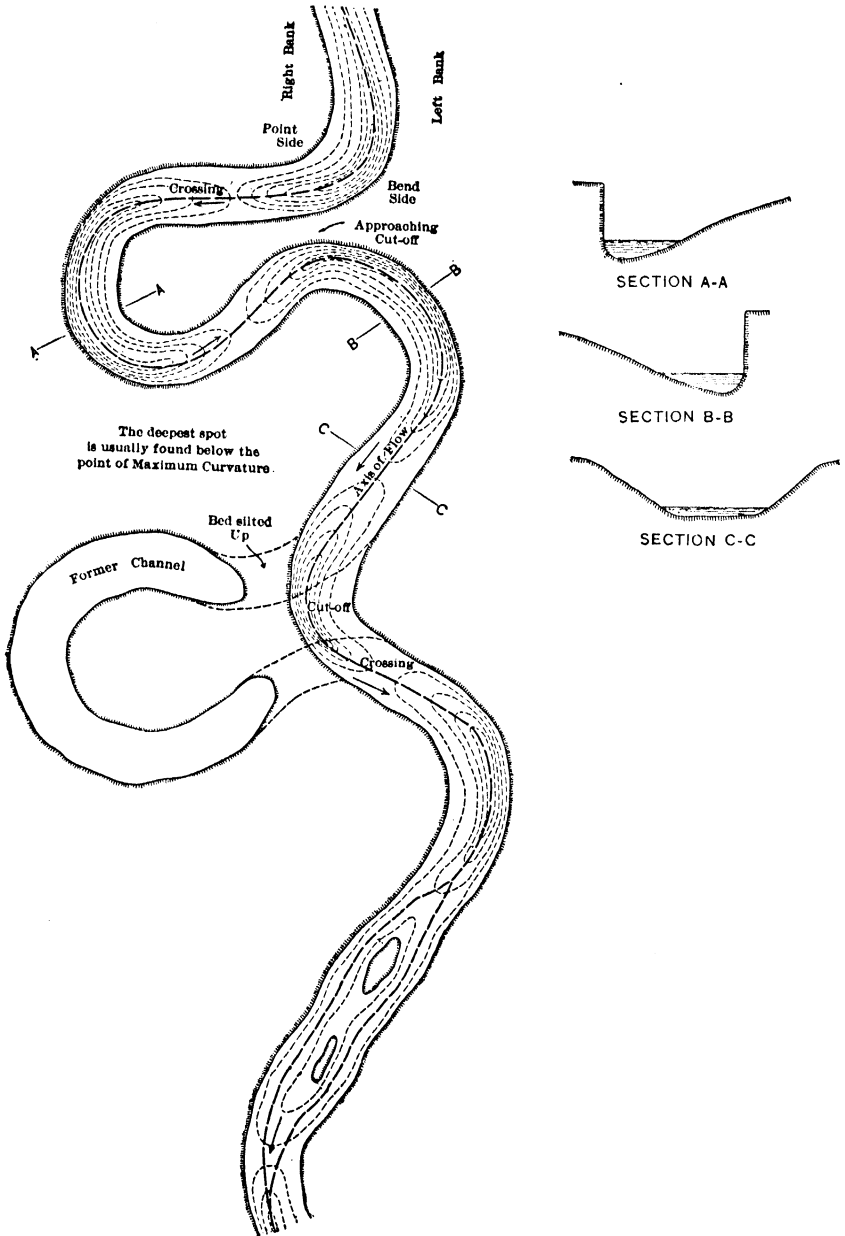

PLATE XL. — Plan and sections showing typical features of a meandering river.
(After Thomas and Watt.)

With gravel shoals the current must be fast enough to roll the pebbles down the slope. With sand shoals, "the function of the flow over the bottom sets up a series of small eddies transverse to the current, and these in turn throw up sand ripples or ridges perhaps an inch or two in height, with a short down-stream slope and a long up-stream one, against which the water beats, disturbing the particles and carrying them down stream (Ref. 15)."

The material which the falling river has to remove is of varying compactness. If such material has settled it may have become so compacted as to resist the scouring action of the current, and even deflect it. The scouring process is a slow one, and if the river falls rapidly, the bar may become an obstruction to navigation, before there has been enough time to permit its removal by natural processes.

The effect of scour varies as the square of the velocity, and is dependent on the depth of flow. A river with a discharge 10 feet deep and 4 feet per second velocity, pressing on its bed with a weight of 625 pounds per square foot (10 feet of water at $62\frac{1}{2}$ pounds per foot), will have a much stronger scouring power than a brook of equal velocity only 1 foot deep, which would exert a pressure of only $62\frac{1}{2}$ pounds per square foot.

Eddies and currents. — These are most strongly developed during periods of flood, and at such times the main channel in both the bends, and even part way down the crossings is strongly agitated by swirls and currents, of which the "boils" or vertical eddies are the most peculiar. These produce an upthrow of water to the surface, causing it to boil as the water does over a great spring.

It is stated that on the Mississippi during floods "these boils at times spread half way across the river, and may reach a height at their

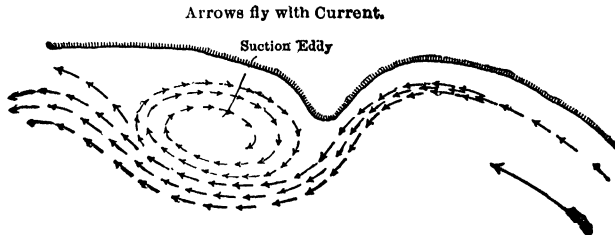

FIG. 128. — Sketch of a suction eddy. (After Thomas and Watt.)

center of some 5 feet above the normal surface of the flow. The resulting disturbance of the water is tremendous and very dangerous to boats, especially when towing; indeed more than one case is known

where craft have been caught and sunk by these sudden cross currents." (Ref. 15.)

Two other types of eddies are those known as *suction* and *pressure* eddies. The former (Fig. 128) are said to be due to the pressure in a caving bank of a hard stratum, which is eroded slowly and which gradually forms a "false point" projecting into and deflecting the current. These suction eddies may be several hundred feet wide and long. A pressure eddy is commonly caused by a sudden change in direction of

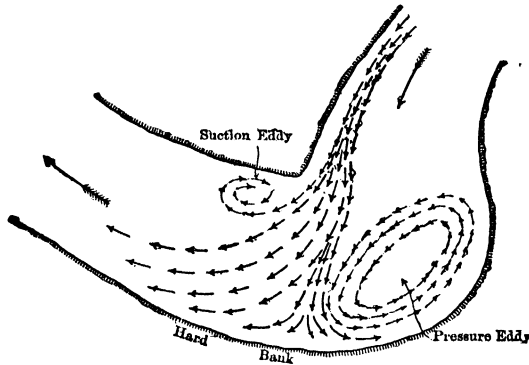

FIG. 129. — Sketch of a pressure eddy. (After Thomas and Watt.)

the current (Fig. 129). There is usually a suction eddy on the opposite bank.

Erosion of banks. — The erosion of river banks is the primary cause of caving or slipping. It may be due to: (1) Water eating into the base of the bank; (2) the presence of an easily eroded layer of sand at the base of the bank, whose removal robs the latter of its support; and (3) the sudden fall of the river leaving a saturated bed unable to support the overlying load of the bank. Erosion is most active on the concave bank, or where there are eddies, and in either case goes on chiefly during periods of high water.

Figure 130*a-c* shows the successive stages of bank erosion. Figure 127 shows the action of the current on a bend. Figure 130*a* represents the initial condition of the bank. Figure 130*b* shows erosion in progress, with some caved material forming a temporary protection, which is soon washed away. In Figure 130*c* the bank has been cut back to a vertical surface, just before breaking. Needless to say saturation of the bank by rain water will hasten its collapse. Figure 130*d* shows a basal layer of sand whose saturation and outflow leaves the bank un-

supported. Figure 130e shows the profile which is likely to develop in the presence of hard rock or tough clay.

Protection against such erosion may be had by grading the bank to a flat slope, and covering its surface to high-water mark by non-erodable materials, or by breaking the attack of the water by spur revetments or spur dikes, or guarding the toe with a longitudinal dike of stone or piles. Railway embankments constructed along rapidly flowing streams are not infrequently undermined unless properly protected.

Ice may also play a part in the erosion of a stream channel. If the banks are of soft material, floating ice rubbing into them will remove more or less of the sand or clay. Or again ice that has become attached to the shore when the river freezes over may, when torn loose by the spring floods, detach material from the banks.

Levees. — When a river overtops its banks during periods of flood, and spreads over the flood plain, the sediment is deposited most actively on that part of the plain adjoining the river channel. As a result of this, low alluvial ridges or *natural levees* are built up, which may be a few or many feet in width.

In many regions the height of these natural levees has been increased by artificial means, high embankments being sometimes constructed to protect the alluvial plain from overflow during periods of flood. The most extensive example of levee work in the United States is that of the Mississippi and its tributaries below Cairo.¹

Irregular hardness of river bed. — It is a well-known fact that the grade or slope of a river channel is not always free from irregularities. On the

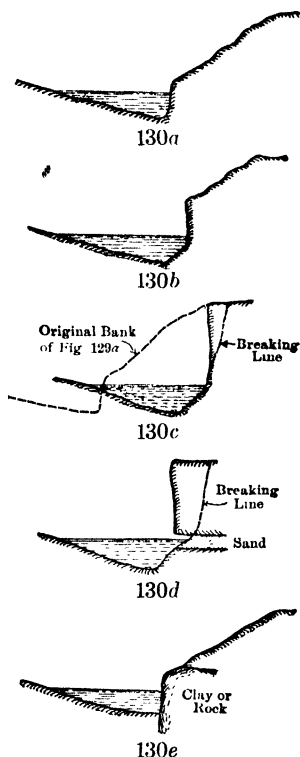

FIG. 130. — Sections showing successive stages of bank erosion. (a) Initial condition of bank; (b) erosion in progress; (c) bank cut back to vertical; (d) saturated basal sand layer, whose outflow leaves bank unsupported; (e) profile developed with hard rock or tough clay. (From Thomas and Watt, *Improvement of Rivers.*)

¹ For an excellent treatment of the subject of levee construction and maintenance see Thomas and Watt. *Improvement of Rivers*, 2d ed., pt. I, p. 243, 1913.

contrary it may show irregularities resulting in the development of rapids, falls, etc.

Falls and rapids. — These are caused by irregularities in the hardness of the rock in the river channel, and form where streams pass from a more resistant to a less resistant rock (Plates XLI, Fig. 1, and XLV, Fig. 2).

Thus, if we have a hard stratum outcropping in the bed of a stream, with softer beds below it, the greater wear of the latter develops sufficient inequality of bed to produce rapids. With progressing erosion and increasing steepness of the stream bed, the rapids change to *falls*. Continued erosion of the soft layer undermines the hard one, and the falls migrate upstream, and although this movement is slow, plotted surveys extending over a series of years often show it clearly. If, however, the resistant rock is vertical (Plate XLI, Fig. 1) and strikes across the stream, the falls may remain stationary until the hard layer is removed by erosion.

A waterfall may be formed in stratified rocks by the presence of hard beds interstratified with softer ones, or in other cases the development of the fall may be due to the existence of a hard dike or sill of igneous rock. Waterfalls may originate in other ways, but the above-mentioned causes are the commonest.

To the engineer the existence of falls and rapids is of importance, because the drop of the stream in a short distance permits its utilization for power purposes, and hydro-electric plants are being constructed at many localities where such powers can be profitably developed.

Waterfalls and rapids, on the other hand, frequently break the navigable continuity of a stream, and have to be passed in different ways. Falls can be passed sometimes by a series of locks, while rapids if not too steep, can be overcome by blasting out the rock ledges in the stream bed, thus making a navigable channel. This was done for example on the Danube River in lower Hungary.¹

Potholes. — In eddies and also at the foot of cascades where the water has a swirling motion, the stones lying on the bottom are whirled around, and excavate cylindrical holes known as potholes, which are often well preserved in the solid rock. They vary in depth and diameter, some being of large size.

Work of Transportation

Transportation of sediment. — A river may transport mineral matter in suspension or in solution. The sediment moved mechanically by a river is either carried in suspension or rolled along the bottom.

¹ See Thomas and Watt, *Improvement of Rivers*, I.



PLATE XLI, FIG. 1. — Waterfalls over vertically dipping limestone beds. (Tomasopo Canyon, Mex.) (H. Ries, photo.)



FIG. 2. — Basalt flow overlying stream gravels, central France. (H. Ries, photo.)

The transporting power of a stream depends on its velocity, and is expressed by the equation

$$T \propto V^6$$

in which T equals the transporting power and V , the velocity. If then the velocity is doubled, the transporting power is increased 64 times. But the velocity depends on grade, volume and load. That is, the steeper the slope the greater the velocity; the greater the volume of flow for a given slope, the higher the velocity. Increased load tends to diminish the velocity. The last is shown by the fact that the velocity of a muddy stream is not as high as when the same stream is free from mud.

Amount of sediment transported.—The quantity of sediment transported by different rivers varies, owing partly to the variable quantity of debris supplied to different streams, and partly to their varying velocity. A swift stream flowing from a lake may even carry very little sediment, because the latter acts as a settling basin to separate the sediment from the water before it leaves it.

In the same stream the quantity of sediment carried will vary with the volume and velocity of the stream during different periods. Indeed, the quantity of sediment per cubic foot of water may not be the same in all parts of the stream's channel. Consequently, in making observations on the amount of sediment in a river, it is important to take samples of the water from different depths, and at different points of the section. The following tables are of interest in this connection.

PERCENTAGE OF MATERIAL CARRIED IN SUSPENSION BY VARIOUS RIVERS¹

River.	Drainage area in square miles.	Mean annual discharge (in cubic feet) per second.	Total tons annually.	Ratio of sediment to water by weight.	Height in feet of column of sediment with a base of one square mile.	Thickness of sediment in inches if spread over drainage area.
Potomac.....	11,043	20,160	5,557,250	1:3,575	4.0	0.00433
Mississippi.....	1,244,000	610,000	406,250,000	1:1,500	241.4	0.00223
Rio Grande.....	30,000	1,700	3,830,000	1:291	2.8	0.00116
Uruguay.....	150,000	150,000	14,782,500	1:10,000	10.6	0.00085
Rhone.....	34,800	65,850	36,000,000	1:1,775	31.1	0.01075
Po.....	27,100	62,200	67,000,000	1:900	59.0	0.01139
Danube.....	320,300	315,200	108,000,000	1:2,880	93.2	0.00354
Nile.....	1,100,000	113,000	54,000,000	1:2,056	38.8	0.00042
Irrawaddy.....	125,000	475,000	291,430,000	1:1,610	209.0	0.02005
Mean.....	334,693	201,468	109,649,972	1:2,731	76.65	0.00614

¹ Babb, Science, XXI, p. 343, 1893.

SEDIMENT TRANSPORTED BY VARIOUS RIVERS

River.	Grammes per cubic meter.			Grains per gallon.			Total cubic yards discharged per annum.
	Min.	Max.	Mean.	Min.	Max.	Mean.	
Arkansas.							26,000,000
Danube.	100	1100	283	6	64	16	78,500,000
Mississippi, Cairo to Gulf of Mexico.	200	2560	800	11	150	46	518,500,000
Missouri.	530	5640		31	330		413,000,000
Nile.	48	1500	313	3	87	18	47,800,000
Rhone.			870			51	27,500,000

Relation of size of particles to current velocity.—Experiments made to determine the relation between the size of particles transported and current velocity give rather uncertain results because of local conditions, such as the volume of discharge.

A river with a fall of one foot per mile can transport a large amount of heavy sediment, while a brook with similar fall can hardly carry silt. It has been noticed also, that while a current of given velocity may carry silt in suspension, a somewhat higher speed is required to erode the same material, and start it moving.

Du Buat¹ gives the following ratios between size of materials and velocities:

	Feet per second.
Potter's clay.	0 26
Sand, deposited by clay	0 54
Large, angular sand	0 71
Gravel, size of peas	0 53
Gravel, size of beans	1 07
Round pebbles, large as thumb.	2 13
Angular flint stone, of size of hen's eggs	3 20

The velocities, sufficient to move gravel of different sizes on the Loire River, were found to be:

	Feet per second.
Gravel 0.04 in diameter.	1 64
Gravel 0.16 in diameter.	3 28
Gravel 0.39 in diameter.	4 92
Gravel 0.69 in diameter.	6 56

It is probable that higher velocities than those given by Du Buat would be required in each case to move the respective sizes.

In irrigation canals leading from the Nile it was found that a velocity of 2 feet or less per second caused suspended silt to settle; 2.3 feet per second caused no deposit; while from 4 to 5 feet per second produced scour. A rate of 3¼ feet per second seemed to prevent both

¹ Quoted by Thomas and Watt.

deposit and scour. According to Buckley, material in place will usually resist the following velocities per second: Sandy soil, from 1 to $2\frac{1}{2}$ feet; ordinary clay, 3 feet; compact clay, from 5 to 6 feet; gravel and pebbles, from 5 to 6 feet.

Relation of sediment to cross-section and slope. — The principles involved in the transportation of sediment by rivers make the chief law, which governs their behavior.

The burden of sediment may vary from mile to mile, but it usually remains in exact proportion of the water required to carry it. A stream may therefore deposit at one point and scour at another; or acceleration of the current in a given stretch along its course may initiate scour, where previously deposition occurred.

“There should be in every part of a river a combined proportion between the discharge, the velocity, and the cross-section of the bed, or the amount of erosion affected by the stream” (Ref. 15). When a river rises in flood, therefore, it should deposit or scour the channel to the extent necessary to permit the passage of the water and its load of sediment. This exact condition is not always attained.

Various factors prevent the stream from reaching a condition of exact equilibrium. Among these are: (1) Local disturbances due to spurs of rock or clay; (2) variations in rapidity of rise and fall; (3) time elapsing between floods; and (4) effect of local rains, etc.

Measurements in low water show, however, that where considerable time has elapsed after a flood, the bends, where the water runs slowly in the low season, tend to silt up in proportion as the shoals, where the water runs fast, tends to erode. As a case in point, measurements taken on the Brazos River in Texas, over a distance of a few miles, comprising several bends and shoals, showed that the comparative areas of the bend and of the shoals sections did not differ by more than 10 per cent.

Change of shape of cross-section. — Since in some rivers the channel may shift from one side to the other, due to deflecting causes of different kinds, it follows that scour may be going on one year at a point where deposition was going on the previous year. The cross-section of the stream bed may consequently vary appreciably from year to year.

Slope of streams. — As already stated the valley slope determines the stream's velocity, and other things being equal we have greater erosion with higher velocity. In general, a river has the steepest slope nearest its head, and least slope at its mouth, but aside from this there may be many local irregularities; and since a rise in the river causes increased velocity and slope, its bed and banks may change.

Tributaries exert an important local influence on a river's slope. If a tributary brings in much sediment, the main stream may receive more load than it can transport, and the sediment is deposited downstream, steepening the river bed in that direction, but reducing it above. "As a result deposits occur and the bed of the river is raised until equilibrium is again reached between velocity and sediment. A sediment-free tributary adds to the volume of the main stream, and it begins to scour until it has its full load of sediment. This results in the slope becoming less than above the confluence of the two streams."

"According to this there should be found corresponding differences of slope at the junctions of the Mississippi, the Missouri, and the Ohio rivers. The upper Mississippi, compared with the Missouri, is comparatively clear, while the volume of sediment of the latter is enormous. The former river, before joining its muddy tributary, should have the lesser slope; after the two streams have mingled the proportion of sediment to the volume of the water is reduced for the one and increased for the other; the slope should therefore become a mean proportioned to the sediments and volumes, and should become less than that of the Missouri, and greater than that of the Mississippi, before their confluence. As the combined flow of the two rivers approaches the Ohio, the sediment becomes reduced by grinding, and the slope becomes less. When the Ohio is reached the former conditions are reversed; the tributary is somewhat the clearer, and the main river somewhat the more muddy. Above their confluence, therefore, the slope of the Ohio should be less and the slope of the Mississippi greater; after their junction the proportion of sediment to volume is lessened for the Mississippi and increased for the Ohio; the resulting slope should therefore be less than that of the Mississippi and greater than that of the Ohio before their junction. Such conditions actually exist." The slope of a river often indicates the character of the material which forms the bed (Ref. 15).

Transportation in solution.—All rivers carry mineral matter in solution, the nature or composition of which varies (p. 296). This material is obtained chiefly from spring waters which have seeped through the soil or rocks before entering the river, or some of it may have been derived by the river water from the rocks over which it flowed.

Whatever the source of this material, the quantity carried by large rivers (p. 238) is enormous. Most of this dissolved material is delivered to the ocean, but a smaller portion is taken to lakes which have no outlet.

The nature and quantity of this dissolved load seriously affects the uses to which river water can be put.

Work of Deposition

A river, carrying sediment mechanically, begins to deposit it when the current is checked. The deposition may occur: (1) In the river channel, (2) on the land bordering its course, and (3) at its mouth or beyond.

Channel deposits. — It has already been pointed out that a stream flowing in soft material may scour its channel at one time and fill it up at another, the former often occurring during periods of flood and the latter during the normal water stage. Many streams, too, which in the upper part of their course have considerable transporting power because of higher velocity, which in turn is caused by steeper slope, will, on reaching the lower part of their course, slacken their speed, and therefore lose some of their transporting power and deposit some of the load. Because of this the channels of many streams are being silted up near their mouths.

The Sacramento River in California affords a most interesting case of a river channel becoming silted up largely by artificial cause. (Ref. 3*b*).

In earlier years, sea-going vessels were able to reach the city of Sacramento, on the river of that name.

With the beginning of the hydraulic mining of the gold-bearing gravel deposits on the western slopes of the Sierras, a great quantity of sediment was washed down into the Feather and Yuba Rivers, tributaries of the Sacramento, and even into the latter stream.

The material deposited decreased in coarseness with increased distance from the source.

The effects of this sedimentation were several: (1) It silted up the river channels so that they were too small to promptly carry off the waters during periods of flood. (2) As a result of conditions mentioned under (1), the river overflowed its banks, and border lands not hitherto covered, became inundated during high water, thus endangering agricultural interests; (3) navigation was seriously interfered with, and (4) during flood periods much of the sediment deposited in the river channel was moved on down into the San Francisco Bay system.

This trouble resulted in the passage of a law prohibiting hydraulic mining, unless catch basins were constructed to stop the sediment from being washed into the rivers.

This has had the effect of preventing the overloading of the streams with sediment, and they have begun to erode their channels. Levees have been constructed to prevent flooding of the neighboring lands, and by-passes have been excavated to carry off excess water during floods.

As an example of the effect of sedimentation, the following figures of the tidal range at Sacramento are interesting:

1849	3 feet
1880	0 feet
1913 following reappearance of current scouring	1.5 feet

It has been estimated that since the beginning of hydraulic mining, 1555 million cubic yards of tailings have been moved, and that to this should be added 800 million cubic yards due to other causes which encouraged erosion in the water shed of the Sacramento and its tributaries, these causes including improper cultivation of the ground, overgrazing and gulying of ditches along steep roads.

About 1146 million cubic yards of this have been deposited in the San Francisco Bay system between 1849 and 1914, shoaling the waters of the bays and reducing their area. This has also diminished the volume of the tidal prism and hence reduced the strength of the ebb tide flowing through the Golden Gate.

Gilbert estimated about 1915 that in the following 50 years the débris now deposited on the shoals in the bays will be increased about 67 per cent.

Aggrading streams. — Rivers which build up their valley bottoms by deposition are said to be *aggrading*. The aggraded material is often built up unevenly, but may sometimes be very deep, the deposits in some old valleys being as much as 1000 feet thick. Some rivers like the Colorado are eroding in one part of their course and aggrading in another. An aggrading stream may be generally recognized by its low slope, broad bottom lands, meandering course, and river bluffs, widely separated. Fords across such streams are likely to be soft, crossing difficult, and the bluffs sometimes of soft material not well suited for bridge piers.

Alluvial plains. — As already pointed out, a stream that has cut down to base level or grade, begins to erode laterally, widening its valley, and developing a curving or meandering course. The stream itself does not occupy the entire width of the valley and is bordered by a flat of varying width. During periods of flood the river overflows this flat, and as the velocity of the stream is reduced over the overflowed flat it may deposit much of its load of sediment on such areas. From time to time this is added to, and the surface thus built up or aggraded constitutes an *alluvial plain* (Plate XLII, Fig. 1).

With further development of the valley the flood plain extends farther up stream, while at the same time its older parts may grow wider due to lateral erosion of the river. In some cases a flood plain may be formed by deposition alone, as when a stream becomes overloaded while its valley is still narrow.

Flood plains may also be caused by either natural or artificial obstructions. A case of the former would be where a stream flows over

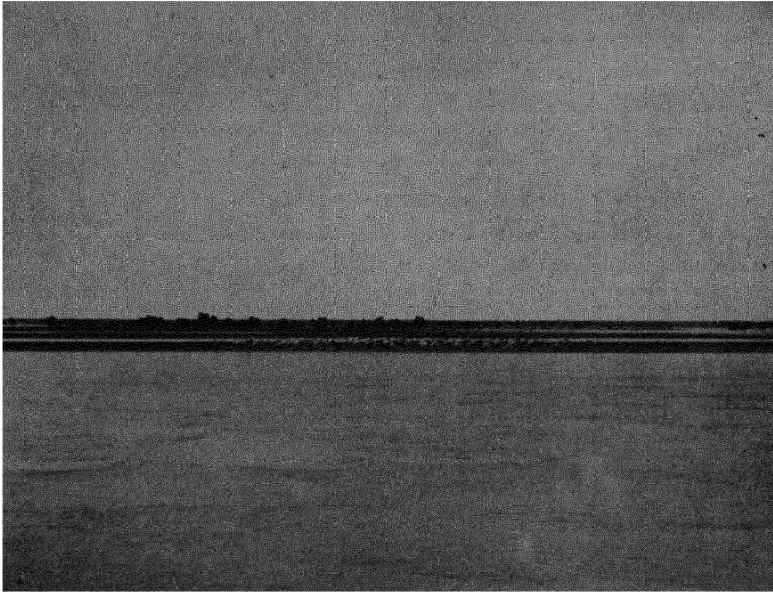

PLATE XLII, FIG. 1. — A flood plain. View along Danube River in Servia.
(H. Ries, photo.)

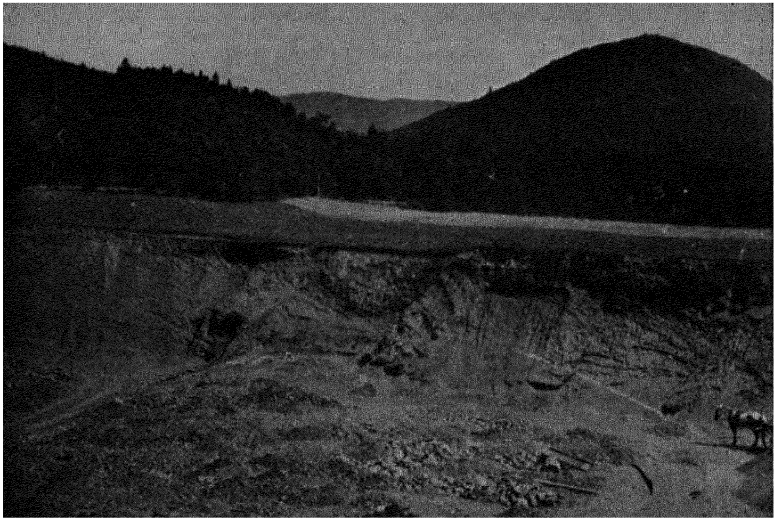

FIG. 2. — Section of ancient delta, Fishkill, N. Y. (H. Ries, photo.)

resistant ledges, which act much like dams, checking the current above them, and favoring the deposition of sediment. An artificial barrier or dam would produce similar results.

In some cases flood plains attain remarkable size, and extend upstream for great distances. The flood plain of the Mississippi has a width ranging from more than 20 miles at Helena, Ark., to about 80 miles near Greenville, Miss.¹

Deltas. — When a sediment-laden stream enters a body of quiet water, its current is checked, and much of the material which it carries will be dropped at once (Plate XLIII). The finer material may be carried farther from the mouth of the river before it settles. Such deposits are termed *deltas*, and their extensive development at the mouths of some navigable rivers calls for considerable attention from the engineer engaged in river improvement, requiring the devising of satisfactory means for maintaining an open safe channel way across the delta to the sea. The cause of this trouble will be better appreciated after the formation of the delta has been described.

The top of the delta deposit is comparatively flat, or to be more exact, the surface slopes gently seaward so long as the river current is as deep as the standing water into which it is discharging, but beyond this the delta surface has a depositional slope. The result is the construction of a delta platform with a relatively flat top, and frontal slope of varying inclination.

As deposition continues, the delta platform is built up (aggraded), and at the same time its margin is extended seaward. The landward margin is gradually built up above sea level, and this land portion is also gradually extended outward.

In the beginning the main flow of the stream across the aggraded delta platform will be more or less in line with the main channel of the river above its mouth, but the current will shift somewhat to left and right, and yet since these shifting currents are of lower velocity than the main one, there will be a tendency for the sediment to build up on either side of the main channel forming natural levees. The main stream then finds itself flowing in a natural trench which it gradually extends seaward, but at the same time is filling up by further deposition. Its capacity to hold the flow of the main stream thus becomes reduced, and the latter finally breaks through the levee at some point, the greater portion of the flow following a new channel, which passes through the same changes as the first one did. The main stream then, if left to itself, will shift from one part of the delta plain to another.

¹ Mississippi River Commission, 1887.

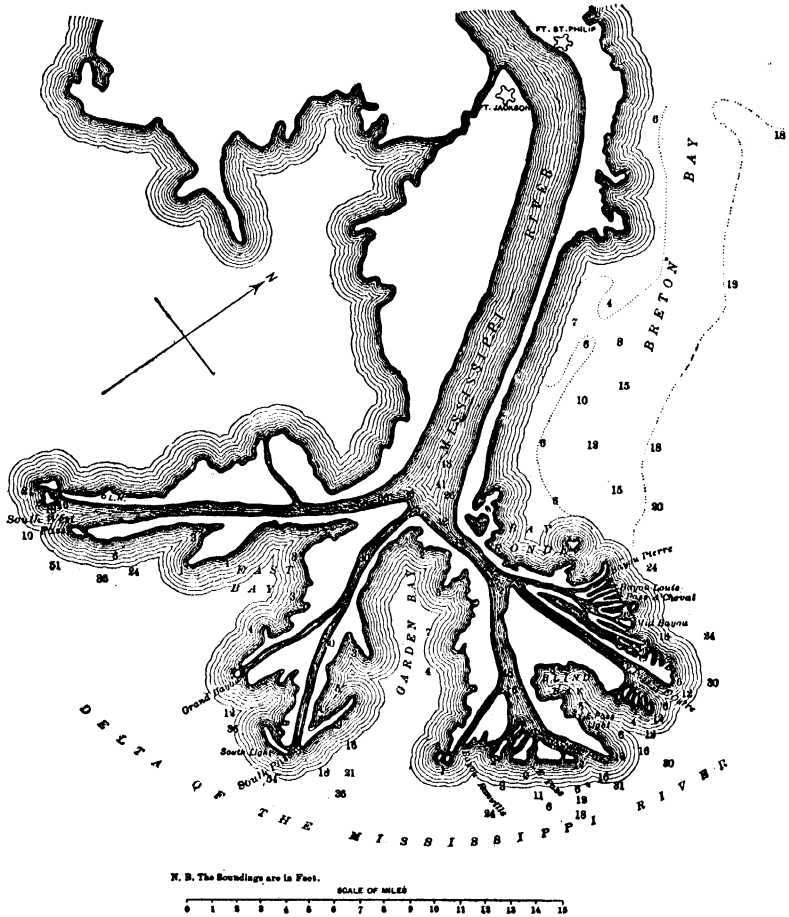

PLATE XLIII. — Plan of Mississippi delta. (From Thomas and Watt, Improvement of Rivers.)

The problem of the engineer, therefore, is to maintain one of these channel ways in a navigable condition out to sea. This may be done for example by "prolonging one of the delta channels by parallel jetties out to the bar, so that the prolonged current, being concentrated across the bar, may scour a deeper channel, and carry its burden of sediment into deeper water further out.

"One of the minor outlets should be selected for improvement, if its delta channel is adequate, or can easily be made adequate for the requirements of navigation; and the discharge of the other outlets should not be interfered with. The advance of the delta at one of the minor outlets is slower, and the distance out to the bar is less, and consequently the jetty works are less costly; whilst an increased discharge, produced by impeding the flow through the other outlets, would also increase the volume of sediment, and therefore quicken the rate of advance of the delta, and hasten the necessity of prolonging the jetties.

"The success of the jetty system depends on a rapid deepening of the sea in front; on the fineness and lightness of the sediment brought down; and on the existence of a littoral current, its velocity, and the depth to which it extends. Any erosive action of winds and waves along the shores of the deltas is favorable to the system, and also any reduction in the density of the sea water, such as may be found in an inland sea.

"If the sea bottom is flat, if a large proportion of the sediment is dense so that it is carried along the bed of the river or close to it; if the outlet faces the prevalent winds; and if no littoral current exists; it is possible that an improvement of the outlet may not be practicable. Then recourse must be had to a side canal, starting off from the river some distance up, and entering the sea beyond the influence of the alluvium of the river.

"The bars in front of the outlets of tideless rivers being formed by the deposit from the river, vary in form according to the nature of the sediment brought down. When the material is composed of particles of very variable density, it is gradually sifted as the velocity of the current decreases, and gives a flat sea slope to the bar. When on the contrary most of the material is heavy, the bar has a flat river slope, as in the first case, formed by the gradual arrest of the sediment rolled along the bottom; but as little of the material is carried beyond the crest of the bar, the sea slope is steep.

"The jetty system does not constitute a permanent improvement, for, sooner or later, in proportion as the physical conditions are unfavorable or the reverse, a bar is formed further out, and a prolongation of the jetties becomes necessary."¹

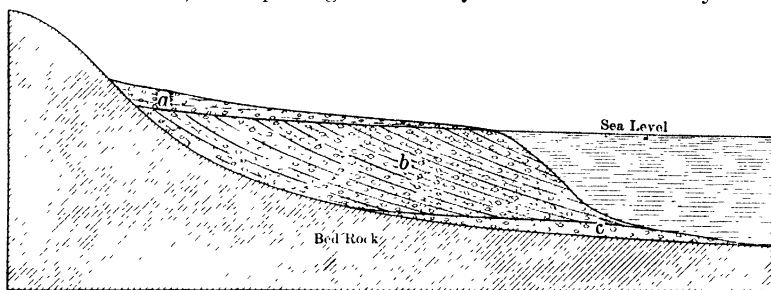

FIG. 131.—Section of delta showing: (a) top-set beds; (b) fore-set beds; (c) bottom-set beds.

Structure of deltas. — In plan deltas are somewhat triangular resembling the Greek letter Δ .

¹ Thomas and Watt, I, p. 311, 1913.

In section the structure is as shown in Fig. 131. Here we see a series of inclined layers, the *fore-set* beds, which accumulated as the sediment rolled down the steep frontal slope of the delta. The finer material carried farther out constitutes the *bottom-set* beds, and these are gradually covered by the fore-set layers as the delta is built seaward. At the same time material is being laid down in horizontal layers on top of the delta, forming the *top-set* beds.

Conditions favorable to delta formation. — All streams do not build deltas. Their absence may be due to lack of sediment, or to waves and shore currents which carry off the sediment as soon as the streams deliver it. A third cause for the apparent failure of delta formation may be the great depth of the water into which the stream discharges, in which case it might take the sediment a long time to build up sufficiently to shallow the water.

Tidal seas then are usually opposed to delta formation, although they are sometimes formed as at the mouth of the Yukon; at the Mackenzie, with three feet tidal fall; the Niger, with four feet; the Hoang-Ho, with eight feet; and the Brahmaputra and Ganges, with sixteen feet.¹

Lakes, bays, gulfs, and inland seas, where wave action and tidal currents are likely to be weak, are favorable for delta formation. Deltas are absent usually, or formed only at the heads of bays, along coasts that have been recently depressed, as in the Atlantic Coast region at present.

Extent of deltas. — The deltas of large rivers are sometimes of vast extent, and are advancing seaward at a rapid rate.

The Mississippi delta, which has a length of over 200 miles and an area of over 12,000 square miles, is said to be advancing into the Gulf of Mexico at a rate of about 300 feet per year. Its depth at New Orleans is estimated at from 700 to 1000 feet.² The Yukon delta has a sea margin of 70 miles, and a length of 100 miles. The Hoang-Ho delta heads about 300 miles from the coast, and has a seaward border of about 400 miles.³

Of historic as well as practical interest is the fact that some towns which were formerly sea-ports are now inland cities, because of delta growth. Thus Adria, formerly a port which gave its name to the Adriatic Sea, is now located 14 miles inland, because of the outgrowth of the Po delta. The latter is said to have advanced about 50 feet

¹ Chamberlin and Salisbury, I, p. 202, 1905; Davis, Physical Geography, p. 294.

² Humphrey and Abbott, Physics and Hydraulics of the Mississippi River; Corthell, National Geographic Magazine, VIII, p. 351, 1892.

³ Dana, Manual of Geology, 4th ed., p. 198.

per year, but more lately the growth has been more rapid due to artificial embankments.¹

Fossil deltas. — Subsequent to the formation of a delta, the waters of the lake or sea in which it originated may be drained off, either due to the cutting down of the lake outlets, removal of the retaining dam (such as a glacier), or elevation of the land, as in the case of the sea or an estuary. These old deltas are often readily recognized by their flat tops, lobate fronts, and characteristic structure.

Along the Hudson River valley in New York state many splendid fossil deltas (Plate XLII, Fig. 2) are found. Others are seen along the old shore lines of the Great Lakes in the north central states, etc.

The fossil deltas often serve as important sources of sand or gravel for structural work, filter beds, etc. In railroad construction they are sometimes drawn upon for material to make fills across valleys. The flat tops of the old deltas often serve as splendid sites for towns, shops or factories.

River terraces. — Many streams are bordered by natural benches or terraces (Plate XLIV, Fig. 1), which are usually somewhat narrow, but may often have considerable length parallel with the river. One or several of these terraces are often present, and form benches on one side of the stream valley, or there may be corresponding ones at the same level on the opposite side, although this is not always the case. In some cases these terraces are so level and well developed as to make the layman suspicious of their origin by natural processes. Terraces are of two kinds, *flood plain* terraces and *rock terraces*.

Flood-plain terraces. — The origin of these was described on an earlier page. To the statement there made should be added that a flood-plain terrace may be chiefly of solid rock, of unconsolidated sediment, or of rock covered by a variable thickness of flood-plain deposit. The material when unconsolidated varies from sandy clay to gravel and large stones.

As a river cuts its channel deeper it may no longer cover the flood-plain terrace in period of flood, but sometimes develops new terraces at successively lower levels. This cutting down of the stream might be due to different causes.

The material underlying flood-plain terraces is often drawn upon for filling or for structural sand. When sufficiently fine-grained and clayey it serves as a source of brick-making earth. The terrace material is at times also sufficiently permeable but retentive to hold ground-water for shallow wells.

¹ Geikie, Textbook of Geology, 3rd. ed., p. 402.

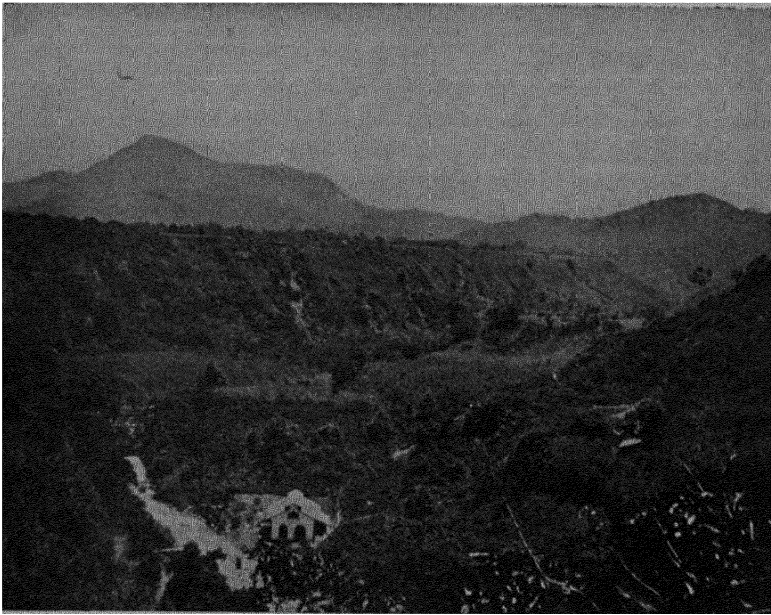

PLATE XLIV, FIG. 1. — High river terrace, Orizaba, Mexico. (H. Ries, photo.)

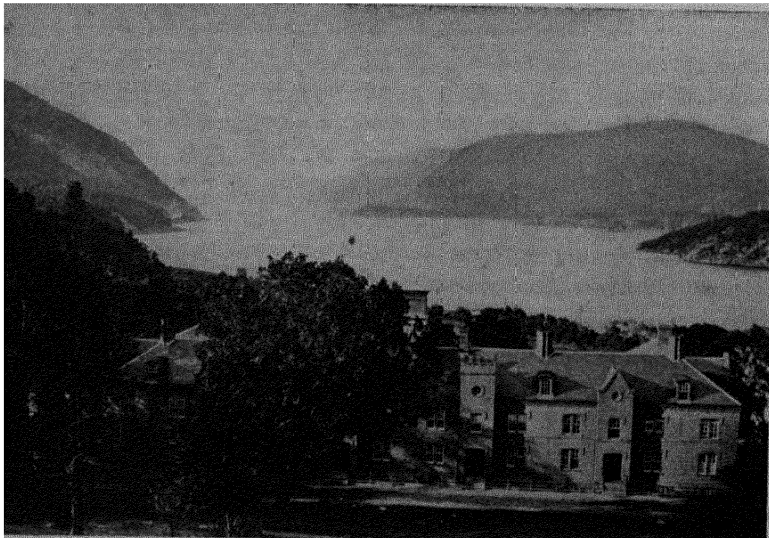

FIG. 2. — View of Hudson River valley, looking north from West Point, N. Y. The river here flows through a deep gorge that has been depressed below sea level, and partly filled by sediment and glacial drift. (H. Ries, photo.)
(286)

Outlets of rivers. — The outlets of rivers are of three general types:¹ (1) Those which discharge directly or indirectly into seas where the range of tide and the violence of the storms are limited, such as the Danube, the Nile, the Mississippi, certain rivers flowing into the Baltic, etc.; (2) those which discharge through estuaries, such as the Thames, the Seine, and the St. Lawrence; (3) those which discharge directly into oceans and are exposed to all the changes produced by sand drift, tidal effects, etc., such as most of the rivers of the Atlantic and Pacific coasts of the United States. Of these three types the third is perhaps the most difficult to improve.

Bars at mouth of rivers. — Bars, sometimes constituting a trouble or even menace to navigation, are found at the mouths of nearly all rivers. They may be formed in several ways:

1. In the case of sediment-bearing rivers like the Mississippi, Nile, Amazon, etc., or rivers entering lakes or inland seas, the checking of the current on entering still water causes it to drop its load resulting in the formation of a bar.

2. Where a river enters a lagoon or bay of a tidal sea, the bar may be formed by wind and waves driving sediment across the mouth (see Bars, under Ocean Waves and Currents, Chapter VIII), and the river channel is kept open by tidal currents.

3. The formation of a bar across the mouth of a tidal estuary may be due to eddies and still water produced by ebb and flood currents at the entrance, or to littoral or shore currents which drift material across the mouth of the estuary.

DRAINAGE FORMS AND MODIFICATIONS

Development of valleys and tributaries. --- A valley usually has its beginning in a gully formed by rain-wash. This serves as a line of concentration for more surface water during successive storms, and so becomes enlarged, being washed out deeper each time. At the same time it may be lengthened by headward growth (erosion) and widened by rain-wash from the sides. Irregularities of slope are likely to produce sinuosities in the stream, which are the beginnings retained by the valley when it has developed more. Since the water flowing down the slopes of a gully follows lines of depression, so branch gullies originate from similar inequalities of slope or hardness of rocks, and these tributaries develop in the same manner as the main stream. Tributaries as a rule join their main stream with the acute angle up-stream.

Although a valley may develop up-stream, that is headward, it will continue until it reaches a point where erosion from the opposite direction counterbalances it. If, however, erosion on opposite sides of a divide is unequal, the latter will slowly move towards the side of less rapid erosion.

¹ Thomas and Watt, I, p. 309, 1913

If on a new land surface we have a series of somewhat parallel gullies developed, these will tend to concentrate the drainage. A gully widens by water entering from the sides, and lengthens by wash at its upper end. Every gully, however, does not develop into a stream valley, for if one deepens and widens more rapidly than a neighboring one, the latter may become absorbed or eliminated by the destruction of the ridge between them. Moreover, those gullies which develop headward more rapidly will send out tributaries, and cut off the up-slope supply of those which did not work headward as fast.

If on a new land surface we have developed a series of somewhat parallel valleys, they will occupy a series of trenches, separated by elevations as yet not much dissected by erosion, although a few tributaries may have developed. As the stronger streams deepen and widen their valleys these inter-stream areas become narrower. At the same time the tributaries increase in number and intersect the inter-stream areas, cutting them into a series of cross ridges. By a continuation of this process these ridges separating the valleys become obliterated by erosion and weathering, resulting in reducing the land surface to a nearly common level and in the development of a *penplain*.¹

If a drainage system develops on a series of rocks of unequal hardness, the hardest rocks will resist erosion most, so that they remain as ridges even after the soft rocks have been leveled down.

If a stream crosses a tilted bed of hard rock lying between softer ones, the valley will widen more both above and below the hard bed than it does where the stream crosses it. If the hard beds are vertical, so that their outcrop does not shift as erosion proceeds, a *narrows* is developed.

The formation of gullies may begin without much regard to the degree of hardness of the rocks, but with further development the relation of streams to rock structure often becomes emphasized. Thus a stream flowing over a soft, less resistant rock, deepens its valley more rapidly than one flowing over hard rock. More rapid erosion also takes place when a stream flows across rocks of unequal hardness, than over rocks which are all hard.

As time goes on the streams show a tendency to follow the softer formations, so that the harder ones become divides, and there is thus an adjustment of the streams to rock structure. Joint planes, because they are lines of weakness, may also exert a guiding influence on stream drainage.

Piracy.— Neighboring streams do not always develop with equal rapidity, because of unequal conditions, such as difference in slope,

¹ If a penplain surface is uplifted, the meandering stream flowing across it cuts downward again and becomes an *intrenched meander*.

character of rock, size of streams, etc. One stream gains the advantage over the other by more rapid development through headward erosion, so that the more able-bodied stream constantly pushes the divide into the territory of its weaker neighbor, and its headwaters finally cut into the upper reaches of the other. Thus the head of the second stream or even one of its tributaries becomes diverted into the channel of the first. This is known as *piracy*.

As shown in Fig. 132, Beaverdam Creek once flowed across the Blue Ridge, which at Snickers Gap is of hard rock. The stream was

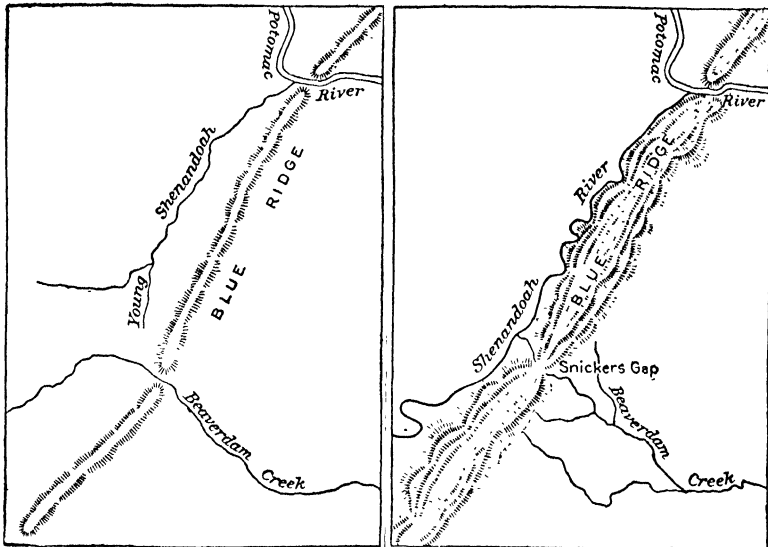

FIG. 132. — Stream piracy. (After Willis.)

unable to deepen its bed across the hard rock of the ridge as rapidly as the larger Potomac lowered its channel across similar rock. The result was that the head of a tributary of the Potomac worked back and tapped Beaverdam Creek. By this process the water gap (at Snickers Gap) became a wind gap.

Young and old topography. — Narrow and steep-sided valleys cut in a land area of a humid region are said to be *young*, and the territory traversed by them is in its *topographic youth*. Young streams are usually swift, they cut vertically rather than horizontally, and their grade is often interrupted by rapids and falls. At this stage the stream has acquired but few tributaries. Valleys approaching base level develop flats. As these flats widen, and the tributaries increase in number and

size, the valley slopes become gentle, and the topography is said to be *mature*. In Plate XLV, Fig. 1, we see a young valley tributary to a mature one.

Old streams usually have a low grade, and a sluggish current. They erode during floods, and deposit their load and fill their channels at other times. Meandering is a characteristic feature of old streams, as illustrated in the Mississippi.

Formation of canyons. — A high altitude is favorable to the development of swiftly-flowing streams and deep valleys, and if the conditions promoting widening are absent, the valley will be narrow. In arid climates the conditions are usually favorable to the development

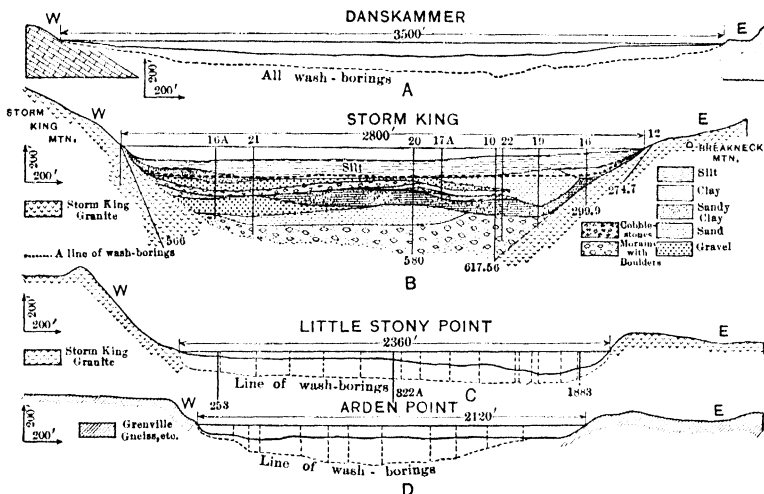

FIG. 133. — Sections across the Hudson River Valley. A, the Danskammer crossing; B, the Storm King crossing; C, the Little Stony Point crossing; D, Arden Point crossing. (After Kemp, Amer. Jour. Science.)

of deep narrow valleys or *canyons*. Firm rock is also a condition favoring their growth. The Colorado canyon is one of the finest examples of its kind known. A small canyon is usually termed a *gorge* (Plates XLV and XI).

Buried channels. — The drainage systems of a region are sometimes seriously disturbed by natural processes. Thus lava flows may obliterate the river valleys of an area, and necessitate the establishment of new ones, but of more practical importance to the engineer perhaps, because of extensive areas affected, is the displacement of drainage by glacial action. Prior to the advance of the continental ice

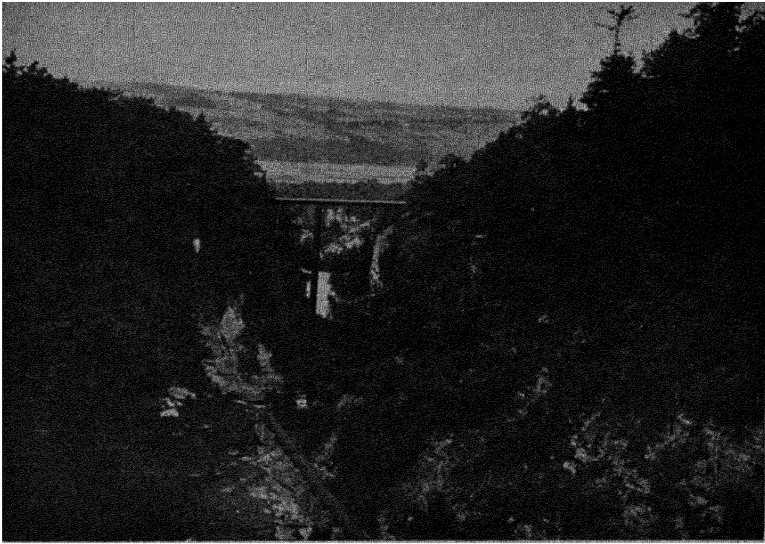

PLATE XLV, FIG. 1. — View looking west down Fall Creek gorge, Ithaca, N. Y. A post-Glacial gorge cut in shales. In the distance is seen the valley at the head of Cayuga Lake; a mature valley with gently sloping sides, and filled in by drift and delta deposits to a depth of over 400 feet.

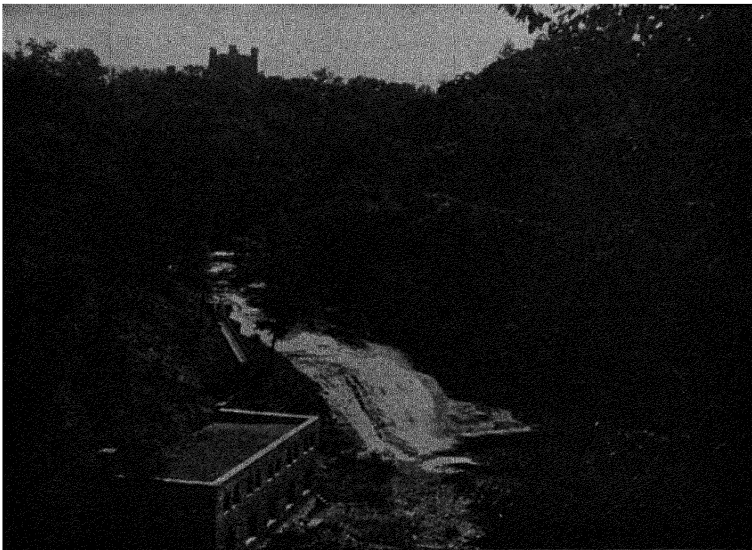

FIG. 2. — View looking east up Fall Creek gorge, Ithaca, N. Y. Falls flowing over horizontal strata.

sheet in recent geologic times, there were well-established drainage systems. In many cases the pre-Glacial river valleys were completely filled with glacial drift, so that after the ice withdrew these rivers had to cut new valleys. In some cases these new (post-Glacial) valleys were cut in the drift filling of the old or pre-Glacial valley (Fig. 191), in others the river has cut a gorge in the rock at one side of the buried channel (Plate XLV, Figs. 1 and 2), and in still other cases a part of the present valley is excavated in the glacial filling and a part in the solid rock.

These buried channels are not always known to the engineer, and when encountered, as they sometimes are, in tunneling operations, they may be a source of both surprise and trouble. Several buried channels were encountered in the construction of the Catskill aqueduct for New York City, and are referred to in Chapter X.

A remarkable case of a partly buried valley is that of the Hudson River. In recent geologic times the land of the Atlantic coast stood much higher, so that the Hudson River carved a deep gorge, whose continuation can be traced by a trench on the sea bottom some distance beyond New York bay. Similar valleys carved in the submerged continental shelf bordering the Atlantic Coastal Plain have been traced opposite the present mouths of several of the pre-Glacial streams of the eastern United States. Subsequently the land was depressed lower than it is now and the Hudson River gorge was filled by clay and sand brought down by the river, and in part by glacial drift (Fig. 133). This was followed by a slight re-elevation, bringing the estuary clays about 200 feet above present sea level in the Highlands. When it became necessary recently to carry the new aqueduct under the Hudson (Plate XLIV, Fig. 2) by means of an inverted siphon, the engineers found it necessary to go nearly 1000 feet below the river level in order to cross in the rock bottom.

FLOODS, RESERVOIRS AND DAM FOUNDATIONS¹

Floods and their regulation. — A river which is irregular in its discharges may cause trouble: First, by having a deficiency of water for navigation, power or other purposes in dry weather, and second, by discharging an excess during another period, the volume being dangerous to navigation and injurious to property.

The prevention of damage by floods is a subject to which engineers and others have given considerable thought, and on which much money has been expended, sometimes with but little reward.

The causes of disastrous floods are: (1) Excessive rainfall; (2) rapid

¹ See further, p. 349.

melting of accumulated snow; (3) failure of reservoirs; (4) formation and failure of ice jams; and (5) the breaking of levees. These may act singly or jointly, and the great problem is the prevention of flood damage by causes (1) and (2).

As stated by Thomas and Watt,¹ "Nature has indicated one satisfactory method of improving the navigability of water courses, in the lakes which lie at the foot of mountainous regions and from which rivers flow. By them the length of the navigable season is increased and the damage from floods is decreased, and the lesson taught is that where artificial lakes or reservoirs can be constructed near the sources of streams, the waters falling in the various basins leading to these reservoirs may be usefully stored up. Not only will the excess of water thus be held back while that entering lower down is making its escape, thereby preventing a flood, but it may be drawn out as required by the necessities of navigation and to its great benefit.

The best example of natural reservoirs known in the world is the chain of Great Lakes, which exercises a complete control over the St. Lawrence River.²

Since the natural method of control seems to work, an artificial method, by the construction of artificial reservoirs, on the tributaries of a large main stream, suggests itself, and while it appears practicable in the case of small rivers, the cost involved seems to many to prohibit its application to large river systems.

A commission which was appointed by the city of Pittsburgh to look into the matter of reducing floods on the Allegheny and Monongahela rivers, recommended building seventeen reservoirs in the water shed above the city at an expense of \$20,000,000. Such reservoirs it was claimed would not only take up the surface water during floods, but in time of drought the water in them could be let out to raise the level of the river the necessary amount.

One of the most disastrous floods in recent years was that of the Ohio Valley in March, 1913,³ which caused over \$200,000,000 damage. This flood was not an isolated one for the Ohio River has overflowed its banks at some points every year since 1873.

To have controlled these floods by reservoirs would involve holding back tremendous volumes of water. Taking the floods at Cincinnati, for example, it is found that to have kept the highest flood on record at that city below the danger line, would have necessitated holding back above Cincinnati 226,000 million cubic feet of water, representing the dangerous crest or top of the flood. The capacity of the forty-three reservoir sites above Pittsburgh, suggested by the Pittsburgh Flood Commission, is 80,500 million cubic feet, while preliminary surveys made by the U. S. Geological Survey in the Kanawha River drainage basin showed seventeen reservoir sites with 280,000 million cubic feet capacity. However, there are other tributaries of the Ohio River, and to control these would require a very large storage capacity.

¹ Improvement of Rivers, I, p. 281, 1913.

² For an excellent discussion on this subject see Reservoir Sites in Wyoming and Colorado, by H. S. Chittenden, House Doc. 141, 55th Congress, 2nd Session, 1898.

³ U. S. Geol. Survey Wat. Sup. Paper, 334, 1913.

Ice gorges. — In some streams the ice, when it breaks up, becomes piled against some obstruction such as a shoal or bar and forms a temporary dam. Such a dam may obstruct the stream flow to a considerable extent, so that when the pressure of the water behind the dam causes it to burst, a serious flood may result. In some cases the ice dam bursts and naturally passes down-stream, only to become lodged again at another point below.¹

It seems difficult to prevent floods due to ice gorges on streams, and it is sometimes almost impossible to keep an open channel in winter. Explosives are occasionally used, but the stream often becomes blocked for many miles. About the only remedy to be applied is to remove, as far as possible, the causes stopping the movement of ice.

Silting up of reservoirs. — Many rivers carry a considerable amount of suspended matter, which settles out in the reservoirs, the result being that in a comparatively few years the storage capacity is greatly reduced. Much trouble from this has been experienced in some of the western states.²

Dam foundations. — In dam construction it is essential that the foundations be sufficiently strong to bear the weight of the dam and also sufficiently tight to prevent seepage under or around the structure.

Many dam failures are due to neglect to thoroughly investigate the character of the foundations, for soundings and borings should be carefully made before finally locating any dams or locks.

Care should be taken not to mistake boulders for bed rock. The need of these precautions is not only to insure the safety of the dam, but also to save expense, for it is often very costly to patch up defective foundations after the work is once started.³

Bed-rock foundations. — In some cases the bed rock outcrops at the surface, or has but slight covering over it on the stream bottom.

Care should be taken to ascertain its tightness and continuity. Limestones may have solution channels,⁴ which permit underflow, and these should be filled up, or else, if of shallow nature, the bed rock should be removed until it is solid. Sandstones may have interbedded shale layers, which become softened by percolating water, causing the foundation rock to slip. Porous sandstones may also permit leakage.⁵

¹ See for example case of Susquehanna River Flood, Pa., U. S. Geol. Surv., Wat. Sup. Paper 147, p. 25, 1904.

² Eng. News, XLIII, p. 135, 1900; U. S. Geol. Surv., Wat. Sup. Pap., XL, p. 36, 1900. Eng. News-Rec., XCI, p. 380, 1923 (Austin, Tex., reservoir); Eng. and Contract., LII, p. 294, 1919 (Zuni reservoir); Eng. News. Rec., LXXIX, p. 169, 1917 (Calif. reservoirs); House Doc. 791, 63d Congr., 2d sess., p. 117, 1914 (San Carlos reservoir).

³ See also Lapworth, Min. of Proc. Inst. Civ. Eng., CLXXIII, p. 298, 1908; Saville, Eng. News Rec., LXXVI, p. 1229, 1916; Berkey, N. Y. St. Mus. Bull. 146, 1911; Du Toit, S. Afr. Soc. Civ. Engrs., 1922.

⁴ Wat. Sup. Pap., 580-A (Carlsbad, N. Mex., reservoir).

⁵ Proc. Amer. Soc. Civ. Engrs., XLVIII, Sep. 1922 (Lees Ferry dam).

Some stratified rocks are so seamed by joint planes, especially near the surface, as to give cause for concern on account of danger from seepage. Among the igneous rocks, the porous volcanics, and especially tuffs and agglomerates, are sometimes liable to be very porous and need grouting (see page 59).

It must not be assumed from what has been said above that the types of rock mentioned always cause trouble, but these cases are cited simply to show the need of precaution.

Where solid rock is struck, it should be bored to a sufficient depth to prove that it is not a thin layer, such as a lava flow resting on other material (Plate XLI, Fig. 2), or an overhanging ledge of a buried stream channel. Moreover, it must not be assumed that because bed rock is found at a given level on one side of a river, that it will be found at a similar level on the other side. Valleys along the contact of two formations may, as explained on page 219, be a line of weakness and solubility. Intrenched meanders cut in limestone may have an underground solution channel connecting the two ends of a curve, so that some of the flow follows this short cut.

Unconsolidated material. — This may consist of gravel, sand or clay, either alone, or interbedded or intermixed. These materials if found in the valleys may represent river deposits, lake deposits or glacial deposits. If the last, the material might be either modified drift (Chapter X) consisting of indifferently bedded sand or gravel, or it may be till (Chapter X), a heterogeneous mixture of boulders, clay and sand.

Unconsolidated materials should be carefully tested for dam foundation work, for although they may consist of dense, water-tight material on top, there may be permeable beds or lenses below.

Gravel foundations usually permit seepage. With sand, or clay and sand mixed, there is danger of seepage or undermining from above, and danger of erosion on the down-stream side of the dam. Sheet piling is commonly used to protect it on the up-stream side. Coarse and fine sand mixed seem to have a greater bearing power than sand and clay. Clay is not a very common foundation for structures in rivers, but when present may vary from the compacted silt of abandoned river channels to the hard clay which will stand a strong current almost unaffected. This last variety of clay is rare in river work, but is excellent for foundations, as it is water tight and usually of high bearing power. With the softer variety of clay it is not safe to trust much to the bearing power of the material unless it has been shown by tests to be reliable in this respect. Even when confined by sheet piling (as should always be done on those sides of the structure where there is any possibility of the material spreading under concentrated load), such clay is

liable to flow gradually and produce displacement of the masonry under the varying pressure of the water thrust, and during construction the weight of the banks will often force up the material in the excavation for the floor, as the weight becomes unbalanced by the operations. (Thomas and Watt.)

COMPOSITION OF RIVER WATER

In addition to suspended and also colloidal matter, which may consist of silica, iron oxide or alumina, river water may contain dissolved gases such as carbon dioxide, and various dissolved solids. These expressed in ionic form include iron, calcium, sodium, aluminum, magnesium, potassium, hydrogen, carbonate radicle (CO_3), bicarbonate radicle (HCO_3), sulphate radicle (SO_3), nitrate radicle (NO_3), and chlorine.

This dissolved mineral matter may be derived from: (1) Spring water, which is the chief source; (2) solvent action of the river water on its banks, or on the grains of sediment which it carries; (3) rain wash; and (4) artificial sources as factories, sewers, etc. The last may cause considerable contamination by discharging both mineral and organic substances into the river.

The composition of river water is of considerable importance for several reasons, which follow:

1. To be used for drinking purposes the water should be hygienically pure and free from contamination, and for this reason much attention is now given to the condition of watersheds whose drainage is drawn upon for municipal supplies.

2. For different manufacturing purposes the water should be free from certain deleterious substances.

3. If desired for steaming purposes, any substances present in sufficient quantity to cause scale, foaming, or other troubles are not desired. Railroads must need give considerable attention to the composition of the water for engines used along the route.

4. In the West waters with a high percentage of soluble salts have sometimes caused damage to bridges and other piers or abutments. Where a porous stone was used, the water soaked into its pores during high water. As the submerged rocks dried out when the river fell, the crystals of soluble salts formed in the pores. Reiterations of this sometimes cause a disintegration of the rock, similar in action to the sulphate of soda test, described under Building Stone in Chapter XI.

The waters of the arid region contain a much larger quantity of salts in solution than those of the more humid regions.

Water used for irrigation should not contain any considerable quantity of soluble salts, as these are injurious to growing crops. The total quantity of soluble salts or alkali permissible cannot be stated, as it depends on the character of the salts, natural condition of soil, amount of water used for irrigation, and efficiency of underground drainage to prevent alkali crusts.

Statement of analyses.¹ — The usual statement of water analyses is a somewhat firmly established though incorrect mode of procedure. If, for example, a water is found to contain sodium, potassium, calcium,

¹ This topic is a condensation of a statement by F. W. Clarke, U. S. Geol. Survey Bull. 695, p. 60, 1920.

magnesium, chlorine, and the radicles of sulphuric and carbonic acids, and these are combined into salts, at least twelve such compounds must be assumed, and there is no definite law by which their relative proportions can be calculated. A combination, however, is usually assumed, and each chemist allots the several acids to the several bases according to his individual judgment. The twelve possible salts rarely appear in the final statement; all the chlorine may be assigned to the sodium, and all the sulphuric acid to the lime. We cannot be sure that the chosen combinations are correct.

With regard to whether the radicles are combined or not, the prevalent opinion, among physical chemists at least, is, that in dilute solutions the salts are dissociated into their ions, and that with the latter only we can legitimately deal. On this basis all water analyses can be rationally compared. There are, however, still some difficulties, such as whether silica is present in colloidal form or as the silicic ion SiO_3 ; and whether ferric oxide and alumina are present as such, or in the ions of their salts. The iron may represent ferrous carbonate, alumina may be the equivalent of alum; but as a rule the quantities are small, and for convenience these substances are regarded as colloidal oxides and so tabulated. If we consider an analysis as representing the composition of the anhydrous inorganic matter which is left when a water has been evaporated to dryness, the difficulty as regards iron disappears, for ferrous carbonate is then oxidized and ferric oxide remains. The same is true of bicarbonates of calcium and magnesium which can only exist in solution and not in the anhydrous residue. If, in a given water, notable quantities of lime, magnesia, and carbonic acid are found, bicarbonic ions must be present, for without them the bases could not be dissolved; but after evaporation only the normal salts remain. Sodium and potassium bicarbonates are not so readily broken down; but even with them it is better to compare the monocarbonates so as to secure uniformity of statement.

Another variable requiring consideration is that due to solution. A given solution may be very dilute at one time, and much more concentrated at another, but the mineral content of the water may be the same in both cases. The ocean water for example has 3.5 per cent saline matter, while the Black Sea has a little more than half as much, but the salts yielded by each on evaporation are almost identical. Occasionally it may be desirable to compare waters directly, but in other cases it is more convenient to study the composition of the solid residues in percentage terms. The following case illustrates the various methods of statement. In the first column the results are given in

oxides, etc., as in a mineral analysis, and in grains to the imperial gallon. In the second column they are stated in terms of salts, and in grains to the imperial gallon. In the second column they are stated in terms of salts, and in parts per million of the water taken. In the third column the composition of the residue is given in radicles or ions, and in percentages of the total anhydrous inorganic solids.

ANALYSIS OF WATER STATED IN DIFFERENT FORMS

Oxides.	Grains per imperial gallon.	Salt.	Parts per million.	Radicles or ions.	Per cent.
SiO ₂	0.891	CaSO ₄	457.7	SiO ₂	1.26
SO ₃	32.601	MgSO ₄	236.0	SO ₄	55.28
CO ₂	4.554	K ₂ SO ₄	9.4	CO ₃	8.78
Cl.....	2.681	Na ₂ SO ₄	62.5	Cl.....	3.79
Na ₂ O.....	11.463	NaCl.....	63.2	Na.....	12.02
K ₂ O.....	0.355	Na ₂ CO ₃	156.9	K.....	0.41
CaO.....	13.117	Na ₂ SiO ₃	21.9	Ca.....	13.24
MgO.....	5.530	(FeAl) ₂ O ₃	2.7	Mg.....	4.69
(FeAl) ₂ O ₃	0.189	Mn ₂ O ₃	2.7	R ₂ O ₃	0.53
Mn ₂ O ₃	0.189	Ignition.....	34.2		100.00
Ignition.....	2.397	Excess SiO ₂	1.3	Ignition omitted.	
			1048.5	Salinity, 1014 parts per million.	
Less O = Cl.....	0.604				
	73.967				
	73.363				

The *salinity* in this case means that one million parts of this water contain in solution 1014 parts of anhydrous, inorganic, solid matter.

Relation of river water to rock formation.—The amount of dissolved mineral matter in the natural surface waters will depend chiefly on the nature and texture of the rock formations in contact with the water, on climatic conditions, and on the amount of vegetation.

It is a well-known fact that two streams flowing over different kinds of rocks may show a difference in composition, and also that a stream, for example, flowing for a part of its course over a limestone formation, and then later receiving, let us say, tributaries which rise in and flow from a schist area, will show a difference in composition in different parts of its course (Ref. 11).

Small streams are most affected by local conditions, and illustrate the greatest differences in composition, while large rivers usually show closer resemblance to each other.

A most interesting case of variation is seen in that of the Cache la

Poudre River in Colorado.¹ This flows first through a rocky canyon over schist and granite boulders, and thence over the plains. It is then diverted into ditches and reservoirs for irrigation, and finally empties into the Platte.

The analyses reduced to ionic form and expressed in percentages of the anhydrous residue are as follows:

ANALYSES OF WATER FROM CACHE LA POUDBRE RIVER

	I.	II.	III.	IV.	V.
CO ₂	31.91	33.68	7 34	10 34	8 78
SO ₄	9.07	23.36	59.99	54 33	55 28
Cl.....	4 03	1.10	2 52	3 19	3 79
Ca.....	14.53	22 58	12 31	15 00	13.24
Sr.....		0 19			
Mg.....	2 93	5.53	6 65	5 00	4.69
Na.....	10.80	5 12	9 84	10 00	12 02
K.....	2 72	1.66	0 34	0 46	0 41
SiO ₂	23 50	6 49	0 94	1 42	1 26
R ₂ O ₃	0 51	0.29	0 07	0 17	0 53
Salinity, parts per million.....	100.00 37	100 00 137	100 00 1571	100 00 958	100 00 1011

I. Cache la Poudre River above the north fork. II. Same, water from faucet in laboratory at Fort Collins; III. Same, 2 miles above Greeley; V. Platte River below mouth of the Cache la Poudre.

The first represents pure mountain water, relatively high in carbonates and rich in silica. At the end of the series the waters are rich in sulphates and low in silica. The change is due to use of water for irrigation and dissolving of constituents from an originally arid soil.

In the California rivers it was found that those in the eastern portion of the state receive but little mineral matter from the resistant granite formations of the Sierras, but that the coastal rivers, draining areas underlain chiefly by loose sedimentary deposits, have a much higher mineral content.

The climatic factor is important as affecting the mode of weathering. In arid and semi-arid regions, disintegration processes predominate, while in humid regions decomposition is usually the dominant process, so that the soluble constituents formed are rapidly removed. However, in arid regions, there may be an accumulation of soluble matter in the soil so that when rainfall comes, the streams carry a high amount of dissolved matter.

In the case of the California rivers it was found that the average mineral content of those in the semi-arid regions is roughly four times that of the humid regions. Differences in percentage composition of

¹ Headden, Bull. Colo. Agric. Exper. Sta. No. 82, 1903, p. 56, and Clarke, U. S. Geol. Survey Bull. 491, p. 60, 1912.

the anhydrous residues show that the waters in semi-arid regions contain about two-thirds the proportionate amount of silica, less calcium, four-fifths as much carbonates, and twice as much sulphates, as the waters of the humid regions.¹

In arid regions, where the rainfall is low, and the streams are more or less concentrated by evaporation, the water may contain so much dissolved salts as to be undrinkable.

River waters of United States.—The following table gives the composition of a number of river waters, and one is struck by their variation in dissolved matter. This difference is not surprising when we consider the source of the dissolved materials.

ANALYSES OF SOLID MATTER IN RIVER WATERS

	I.	II.	III.	IV.	V.	VI.	VII.	VIII.	IX.	X.	XI.
CO ₂	41.66	44.43	28.15	35.45	13.69	47.22	36.02	24.93	32.53	25.29	51.65
SO ₄	5.19	11.17	12.78	15.84	44.85	4.43	8.67	4.90	11.18	10.31	1.05
Cl.....	1.51	2.41	8.78	3.96	4.95	2.14	2.81	6.34	2.79	5.48	0.48
NO ₃				0.79	0.70	1.86	0.37	0.43	0.76	1.12
Ca.....	20.08	20.67	17.14	20.79	18.58	22.85	17.10	8.50	16.52	11.43	22.94
Mg.....	4.52	6.44	4.18	3.76	3.56	5.86	3.66	2.59	3.17	1.77	4.09
Na.....	3.2	4.87	6.16	6.53	6.11	3.86	7.20	10.09	8.78	11.59	5.14
K.....	0.72		tr	1.78	1.08	1.00	1.34	1.87	3.18	3.22	1.75
SiO ₂	23.12	10.01	18.14	10.9	6.35	10.71	21.98	37.47	20.33	28.99	9.40
Al ₂ O ₃			1.34								2.01
Fe ₂ O ₃			3.33	0.20	0.15	0.07	0.85	2.88	0.76	0.80	1.49
Salinity, parts per million....	160	148	108	130	140	89	73	76	59	195

	XII.	XIII.	XIV.	XV.	XVI.	XVII.	XVIII.	XIX.	XX.	XXI.
CO ₂	30.23	38.42	21.51	11.47	24.13	13.70	37.55	2.65	1.54	30.14
SO ₄	20.50	16.30	19.55	42.59	32.77	16.94	14.62	60.69	43.73	12.21
Cl.....	4.10	5.82	16.10	4.12	3.15	34.61	3.77	4.89	22.56	5.79
NO ₃	0.81	1.67	0.82	2.32	0.53					0.48
Ca.....	17.16	18.24	16.10	15.47	15.05	5.62	20.24	12.78	13.43	11.45
Mg.....	5.72	7.76	3.46	2.84	4.37	1.88	5.13	3.76	3.62	5.59
Na.....	8.091	6.98	11.04	8.12	10.68	26.07	9.57	14.50	14.02	9.78
K.....	1.521		2.09	1.42			0.60	0.28	0.77	1.68
SiO ₂	11.44	4.65	9.09	10.82	8.98	0.98	8.19	0.45		19.12
Al ₂ O ₃						0.20	0.33		0.33	3.35
Fe ₂ O ₃	0.43	0.16	0.24	0.90	0.34					0.41
Salinity parts, per million....	202	267	87	81	426	2323	148	2134	2384	118.5

I. St. Lawrence at Pointe des Cascades, near Vaudreuil, above Montreal; II. St. Lawrence opposite Montreal; III. Merrimac River above Concord, N. H.; IV. Hudson River at Hudson, N. Y. Mean of 36 weekly composites; V. Potomac River at Cumberland, Md. Shows effect of drainage from coal mines; VI. Shenandoah River, at Millville, W. Va. Shows influence of limestone country; VII. James River, Richmond, Va.; VIII. Neuse River at Raleigh, N. C.; IX. Cahaba River, near Birmingham, Ala.; X. Pearl River, near Jackson, Miss.; XI. Mississippi River, Brainerd, Minn. Low in sulphates and chlorides; XII. Mississippi River, Memphis, Tenn. Shows higher sulphates and chlorides. These come chiefly from western tributaries, although some of the chlorides may be due to contamination; XIII. Illinois River, near Kampsville, Ill.; XIV. Allegheny River at Kittanning, Pa.; XV. Monongahela at Elizabeth, Pa.; XVI. North Platte River at North Platte, Neb.; XVII. Saline River above New Cambria, Kans. Poor in carbonates but rich in sodium and chlorine; XVIII. Arkansas River, Cañon City, Colo.; XIX. Arkansas River, Rockyford, Colo. No. XVIII is flowing over crystalline rocks, but XIX has been flowing over shales that are both pyritic and gypsiferous. Note the higher salinity also; XX. Pecos River, New Mexico. High salinity, predominance of alkaline sulphates and chlorides, and deficiency of carbonates of lime; XXI. Sacramento River, above Sacramento, Cal.

¹ Clarke, *l.c.*

The preceding table will serve to show how the composition of natural waters may vary.

Chlorine. — Chlorine, which is a constituent of common salt, is present in nearly all natural waters.

It is derived originally from mineral-salt deposits and finely-divided salt spray from the sea, the latter being carried with dust particles by the wind and precipitated with the rain; or, if not thus derived, it may represent the leaching by spring waters of saliferous soils or rocks.

Salt found in waters not coming from these sources comes from domestic drainage and shows that the water is either polluted now or was polluted and has since been purified.

A comparison therefore of the salt content of any water under examination with the normal chlorine content for that region will indicate the extent of past or present pollution.

Jackson¹ states that the "amount of salt in a water is a valuable indication of pollution because of the following facts: (1) The animal body expels the same amount of salt that it absorbs, (2) this salt is unchangeable in the soil and is very soluble in water; (3) it must eventually form a part of the drainage and become mixed with the general run-off of the region in which it is expelled. The average amount of salt entering the drainage of any particular district is so constant for each inhabitant that it has been claimed that the number of people living on a drainage area may be determined with a fair degree of accuracy from the average run-off and the excess of chlorine over the normal."

All salt in natural unpolluted waters farther inland than Ohio comes from mineral deposits. The salt winds from the sea have no effect beyond this state, but unfortunately west of this state a large proportion of the natural waters are more or less affected by the salt deposits. The underground salt seems to spread over a broad area and exerts not only a wide but a variable influence over most of the waters. In these inland states, while the 'normal chlorine' would be practically zero the value of the determination of chlorine is in most cases vitiated by the variable quantity of salt from mineral sources.

Determinations of chlorine in samples of water taken above and below a city which runs its drainage into the stream examined may give the extent of pollution due to the city sewage, but the waters so far analyzed in the inland states give indications that the question of *normal* chlorine does not to any great extent enter into sanitary problems.

Clarke (Ref. 3) in referring to A. W. Palmer's² work mentions the Chicago drainage canal as a good example of pollution. This empties into the Desplaines River and thence passes through the Illinois River into the Mississippi. The annual averages for 1900, representing the Illinois River, are given below and show a decrease in chlorine as we go down-stream.

¹ W. S. Pap. 144, p. 9, 1905.

² Chemical Survey of the Waters of Illinois, 1897 to 1902, Univ. of Ill., 1903.

	Total dissolved solids, parts per million.	Chlorine.	
		Parts per million.	Per cent.
Illinois River:			
At Morris.....	235.3	23.1	9.82
At Ottawa.....	269.4	21.4	7.94
At La Salle.....	245.4	18.7	7.62
At Averyville.....	245.2	17.5	7.14
At Havana.....	236.3	14.8	6.27
At Kampsville.....	234.3	14.0	5.98
At Grafton.....	232.6	13.1	5.63
Mississippi River at Grafton.....	150.1	3.1	2.06

Carbonates in water. — The effect of carbonates in water is discussed on p. 347, and need not be repeated here; suffice it to state that the degree of hardness may vary with the volume of discharge of the

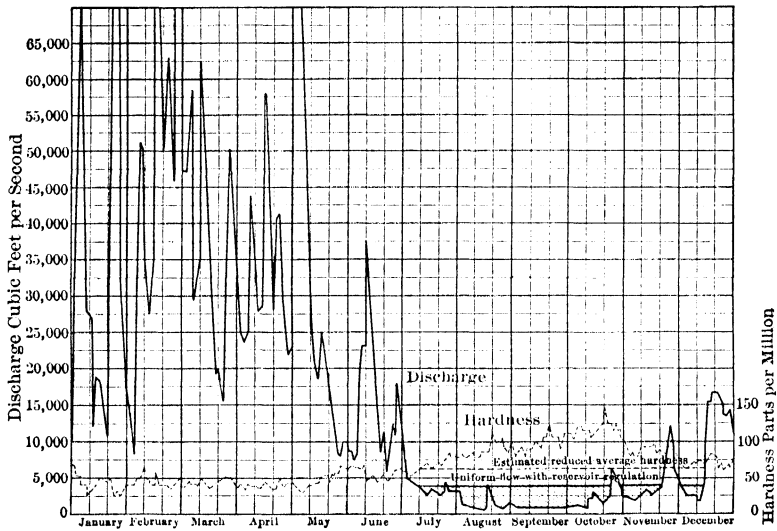

Fig. 134. — Chart showing variation in hardness of Allegheny River water during a year (Pittsburgh Flood Commission report).

stream. Thus in Fig. 134 it will be seen that the hardness expressed in parts per million is considerably less during high water than during low water.

Sulphuric acid waters. — Rivers in coal-mining districts, for example, may be distinctly acid in character, due to sulphuric acid brought from decomposing pyrite, by drainage from the mines.

Thus the Allegheny and Monongahela rivers of western Pennsylvania receive a large amount of coal-mine drainage. It is stated (Ref. 6) that there are 450 mines in the Allegheny basin, and 560 in the Monongahela basin, 150 of which are in West Virginia.

Although considerable mine drainage empties into the Allegheny, especially from the Kiskimetas, the water of the main stream in its

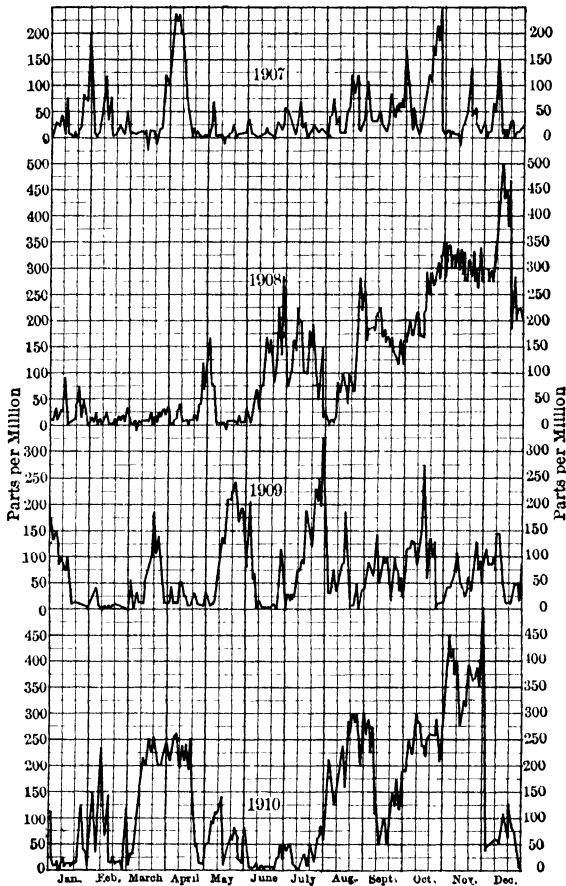

FIG. 135. — Chart showing variation in acidity of Monongahela River water during different years (Pittsburgh Flood Commission report).

lower course has been practically always alkaline. The Monongahela, on the other hand, owing to its smaller discharge (only about one-third the Allegheny at low water), but with greater mining developments in its basin, is highly acid (Fig. 135).

The river men are familiar with this fact and bring the water for their boilers on flat boats from the Allegheny River. The greatest contribution to the acidity of the Monongahela, is the Youghiogheny, as is shown by the following figures.

Monongahela at Clairton	0.45 grains SO_3 per U. S. gallon.
Youghiogheny at Versailles	7.91 grains SO_3 per U. S. gallon.
Monongahela at McKeesport	2.03 grains SO_3 per U. S. gallon.

The acidity of the river is so strong as to exert a corrosive action on boilers, and to shorten the life of exposed iron and steel parts of boats, and canal locks; indeed it is said that three-eighths inch plates have been eaten to a knife edge in one year's time.

References on Rivers

1. Chamberlin and Salisbury, *Geology*, 2 ed., Vol. I, p. 54, 1905. (Holt and Co.)
2. Chittenden, *Amer. Soc. Civ. Engrs., Trans.*, 1908, and *Eng. News*, Oct., 1908. (Relation of forests to stream flow.)
3. Clarke, U. S. Geol. Survey, *Bull.* 695, pp. 65, 88, 1912. (Many analyses.)
 - 3a. Collins, U. S. Geol. Survey, *Water Sup. Pap.* 496, 1923. (Public Water Supplies.)
 - 3b. Gilbert, U. S. Geol. Survey, *Prof. Pap.* 105, 1917. (Sacramento River, Calif.)
 - 3c. (Transportation of débris by running water.) *Ibid.*, 86, 1914.
4. Glenn, U. S. Geol. Survey, *Prof. Pap.* 72, 1911. (Denudation and erosion in Southern Appalachians.)
5. Greeley, *Jour. W. Soc. Engrs.*, XVIII, No. 7, p. 662, 1913. (Rainfall and run-off with reference to sewers.)
6. Heinz and others, *Report of Flood Commission of Pittsburgh, Pa.*, 1912. (Contains excellent bibliography.)
7. Jackson, U. S. Geol. Survey, *Water Sup. Pap.* 144, 1905. (Normal chlorine in N. Y. and New Eng. rivers.)
8. Leighton, U. S. Geol. Survey, *Wat. Sup. Pap.* 79, 1903. (Relation between normal and polluted waters, eastern U. S.)
9. McGee, U. S. Dept. Agric., *Bur. Soils, Bull.* 71, 1911. (Soil erosion.)
10. Newell and Murphy, *Principles of Irrigation Engineering*, 1913, New York. (McGraw Hill Pub. Co.)
11. Palmer, U. S. Geol. Survey, *Bull.* 479, 1911. (Geochemical interpretation of water analyses.)
12. Rafter, U. S. Geol. Survey, *Wat. Sup. Pap.* 80, 1903. (Relation of rainfall to run-off.)
13. Russell, *Rivers of North America*, 1898, New York. (G. P. Putnam's Sons.)
14. Stabler, *Eng. News*, LX, p. 356, 1908. (Interpretation of mineral analysis of water.)
15. Thomas and Watt, *Improvement of Rivers*, 2 vols., 2nd ed., 1913, New York. (Wiley & Sons.)

See also numerous Water Supply and Irrigation Papers published by U. S. Geological Survey, many of which relate to stream gaging.

CHAPTER VI

SUBSURFACE WATERS

Introduction. — It is a well-known fact that the rocks of the earth's crust, as determined by borings and mining operations, contain more or less water. The occurrence, distribution, and movement of this water are of interest to the engineer for several reasons: (1) Subsurface water often serves as a source of water supply, and (2) it frequently affects engineering operations, such as tunneling, dam and reservoir foundations, stability of embankments, etc.

Sources of Subsurface water. — The water found in the rocks may be of three different kinds, viz., *magmatic*, *connate*, and *meteoric*. The first and third sometimes reach the surface as springs, but only the third (meteoric) is of great importance as a source of subsurface water supply, and, therefore, the other two can be briefly disposed of first.

Magmatic water is that which is given off by igneous rock during the process of cooling and consolidation (Chapter XVII). It comes from unknown, variable depths, and is important because it has played an active rôle as a transporting and depositing agent of ore minerals. Such water is occasionally encountered in mine and tunnel workings,¹ and may reach the surface as hot springs. It is not to be regarded as a source of subsurface water supply, but sometimes on account of its high mineral content is of medicinal value.

At Boise, Ida., water which may come from such a source is piped through the town and used for heating and washing.

Connate water is water which is indigenous to the rocks containing it, such as original sea water in a sedimentary rock or magmatic water in an igneous rock. It is occasionally tapped by bored wells.

Meteoric water represents that part of the rain water including melting snow which has soaked into the rocks. It is vastly more important than the other two kinds.

Quantity of rainfall. — Few areas of the United States are entirely free from rainfall, and in some regions it is considerable, averaging from 20 to 70 inches in that portion lying east of the Mississippi (Fig. 136).

To state it in more detail: On the Mississippi Delta below New Orleans, and along the Gulf Coast to Tallahassee, Fla., the precipita-

¹ Comstock Lode, Virginia City, Nev.

tion is 60 inches or even more annually, while a similar amount falls on the coast and in the higher mountains of North Carolina, as well as in the Adirondacks and White Mountains.

In the Gulf and South Atlantic states it is between 50 and 60 inches; in New England, the Central-Atlantic States, and Ohio, between 40

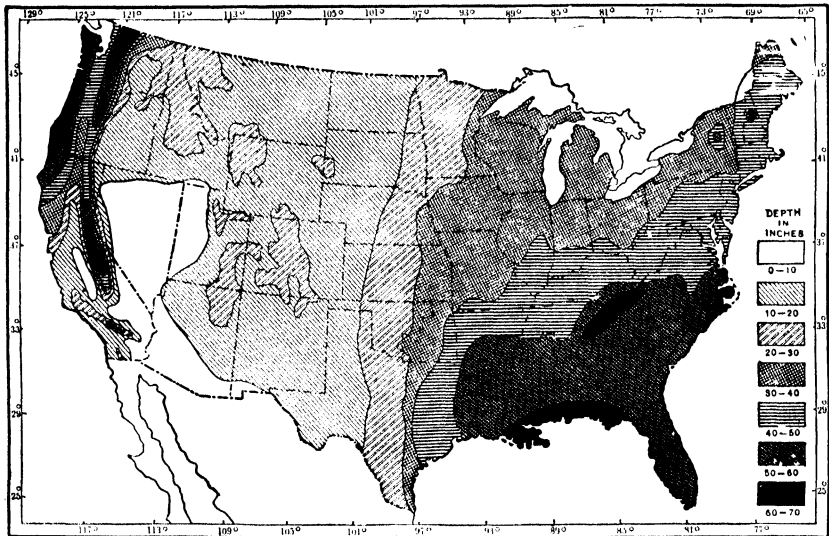

Fig. 136. — Map showing mean annual rainfall of the United States. (After Fuller, Domestic Water Supplies.)

and 50 inches; in the Upper Mississippi Valley and Great Lakes, 30 to 40 inches; in northwestern Iowa and most of Minnesota, 20 to 30 inches. A belt extending north and south through eastern Kansas shows 20 inches precipitation, while in the Black Hills and higher mountains of the Rockies it is 20 to 30 inches. The Great Basin shows only 2 to 3 inches, but the Pacific Coast 70 to 150 inches.

Disposal of meteoric water. — The rain water falling upon the surface may be disposed of by evaporation, run-off, or seepage. The average precipitation of the land is estimated to be about 40 inches per year.

The proportion of rainfall at any given locality, which is disposed of in the ways mentioned above, depends on: (1) Topography; (2) rate of rainfall; (3) porosity of the soil or rock; (4) amount of water already held in soil at time of precipitation of the rain or snow; (5)

the amount of vegetation on the surface; and (6) dryness of the atmosphere.

Evaporation. — This is small while precipitation is going on, but if water or snow remains on the surface, much of it may evaporate especially in clear, dry weather. However, the proportion of rainfall that returns to the air by evaporation varies greatly under different conditions, and will be affected by temperature, wind velocity, character of vegetation, and nature of soil.

It is less in a cool climate with light breezes than in a hot one with strong winds. It goes on more rapidly in cleared areas than in forested ones, and is greater from clayey than from sandy soils.

In the Virginia Coastal Plain, for example, evaporation amounts to more than 50 per cent of the rainfall (see also Ref. 9 for experiments).

Run-off. — Only a small portion of the rain is directly disposed of in this manner, for even though the volume of a stream is large, much of the water in it may have first soaked into the ground, and then rejoined the river by seepage from its banks.

Vegetation and temperature seem to be the chief factors controlling run-off. This has been shown by Hoyt¹ who demonstrates that the winter run-off in Vermont is 92 per cent of the rainfall, and in Virginia 63 per cent, but that the summer run-off is practically the same for the two states.

A high run-off is to be looked for if the ground is saturated with water or frozen, or if the downpour of rain is sudden.

Absorption. — The greater part of the rainfall may be absorbed by the ground, the quantity thus taken up being sometimes as much as 80 per cent in the East and 90 or 95 per cent in the West (Fuller).

This absorption may be directly from the rainfall, or indirectly from the rivers, although in most cases the water in the ground moves towards the streams.

Movement in both directions may take place at different points in a river's course, for in a region of heavy rainfall the water will move towards the river, while in an arid country in another part of a stream's course, it is more likely to seep from the river into the ground. The seepage of water from drainage or irrigation canals into the bordering fields is an illustration of this.³

The chief factors which regulate the absorption of water by the ground are: (1) Surface slope; (2) rate of precipitation; (3) air temperature; and (4) soil texture.

¹ See also U. S. Geol. Survey, Wat. Sup. Pap. 181, 1906, for experiments.

² Trans. Amer. Soc. Civ. Eng., LIX, p. 431.

³ See also Thomas and Watt, Improvement of Rivers, II, p. 389, 1913.

If the slope is steep the water drains off before the soil can absorb it. Less may be absorbed during a heavy shower than during a gentle rainfall, because each type of soil has a certain rate of absorption, and if the water is supplied more rapidly than it can be taken up, the excess runs off.

A high temperature decreases the surface tension of water, and hence it can be more rapidly taken into the soil pores. Sandy soils soak up water more rapidly than clayey ones because they have larger pores.

Subsurface Water

When the water is absorbed by the ground (Ref. 9) some of it is held in the pores of the soil near the surface, but most of it moves downward into the deeper layers of the regolith¹ which it saturates, and some of it percolates still further into the pores, joints, fissures or other openings of the bed rock, wherever it can penetrate.

The upper limit of this saturated zone is known as the *water table*. The water of the saturated zone may be called *groundwater* or *phreatic water* (Ref. 9). This water which is under hydrostatic pressure serves as a source of supply for springs and wells.

The groundwater may extend to different depths in different localities, but on an average the porosity of the rocks decreases as the depth increases. Most of the water in crystalline rocks is found within 300 feet

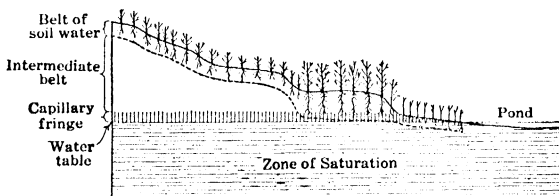

FIG. 137. — Diagrammatic section showing the three belts of the zone of aeration, and the saturated zone beneath. (After Meinzer, U. S. Geol. Survey, Wat. Sup. Pap. 489, 1923.)

of the surface (Ref. 9). Porous rocks which yield water freely have been found at as great a depth as 6000 feet, but most wells drilled deeper than 2000 feet yield little water. Some exceptions are found in Aus-

¹ The term regolith is applied to the mantle of unconsolidated material, which covers the bed rock in most regions.

tralia where there are a number of flowing wells obtaining water from depths of 3000 and 4000 feet.

Extending from the water table to the surface is the *zone of aëration* (Fig. 137), in which the ground is usually only partly filled with water, which for the most part is held only by molecular attraction. This water is therefore sometimes referred to as *suspended subsurface water* or *vadose water*.

The aëration zone may be further subdivided into (1) an upper belt of *soil water*, (2) an *intermediate belt*, and (3) a lower belt, the *capillary fringe* lying immediately above the water table and containing water drawn up from the zone of saturation by capillary action. The zone of aëration may vary in thickness from zero feet under swamps, up to 1000 feet in some arid regions. In most humid portions of the United States it is less than 100 feet thick.

Groundwater

Water table. — The upper limit of the groundwater or *water table* (Fig. 138) agrees somewhat closely with the configuration of the land surface, but is farther from it under the hills and nearer to it under the valleys, indeed it may even reach the surface under some depressions giving rise to springs and swampy conditions (Fig. 138).

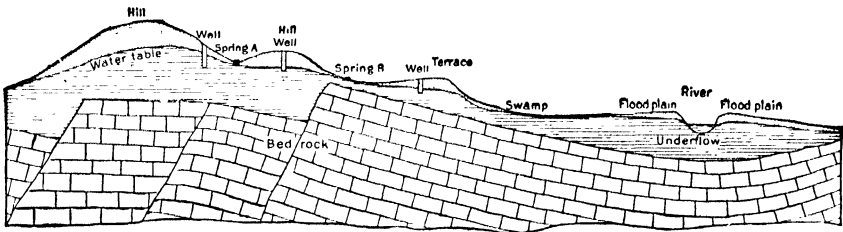

FIG. 138. — Section showing relation of water table to surface irregularities. (After Slichter. From Fuller, Domestic Water Supplies.)

The water table will show the least slope in porous sands, and the steepest slope in clays, so that in the latter it may follow the contour of the surface very closely. Under a flat expanse on a high terrace, for example, the water table may lie close to the surface, whereas near the scarp or front of that terrace it may be 50 feet below the surface.

Its depth below the surface is quite variable, being but a few feet in moist climates, and often several hundred feet in arid regions, but in any given area the water table may fluctuate due to different causes mentioned later.

In solid rocks there is no continuous zone of groundwater such as is found in the regolith, but the water filling joint fissures may rise to the same general level.

Movement of groundwater. — The groundwater tends to move in the direction of the steepest slope of the water table, consequently its flow will roughly parallel that of the surface drainage (Fig. 139).

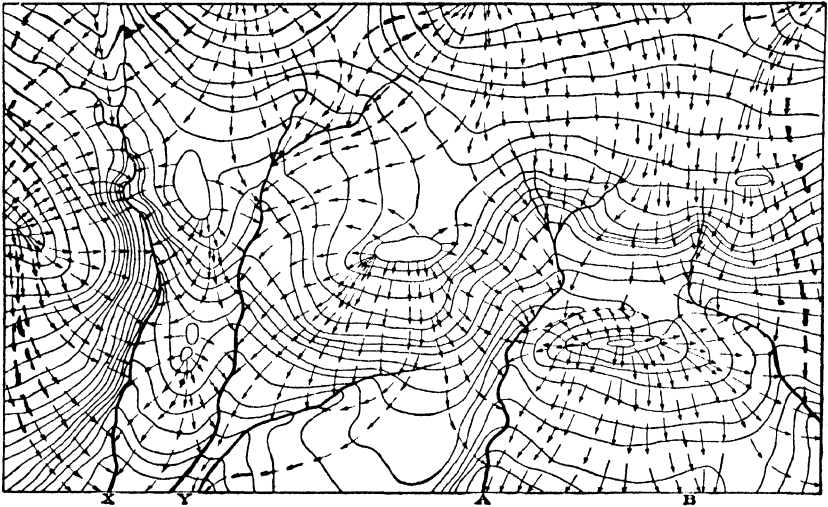

FIG. 139. — Map showing position of water table by contours (continuous lines), lines of motion of groundwater (arrows), and surface streams. (After Slichter, from Fuller, Domestic Water Supplies.)

It thus flows down towards the valleys, where it often seeps into the channel of the stream occupying the depression, thereby augmenting its volume.

In some valleys carved in bed rock the surface stream flows in a channel cut in a filling of glacial drift or stream deposits, and then some of the groundwater may form an underflow in this porous material, beneath the stream channel, but not always exactly coincident with it.

Instances are known where this underflow is separated from the surface stream by more or less impermeable clay or silt layers which prevent the groundwater from uniting with the river water. We thus

have at times the case of a surface stream of impure water, and below it an underflow of very good water. The latter can be drawn upon for a water supply, while the former is unsafe to use.¹

The magnitude of the underflow depends on (Ref. 9): (1) The average gradient of the river valley; (2) the depth, width, and composition of the beds underlying the stream; and (3) the fineness of the material.

Another type of underflow is found in some regions, where the valley floor along the foot of a mountain range is underlain by open gravel and sand deposited by swiftly-moving streams from the canyons or valleys in the foothills (Fig. 140). As these streams emerge from the hills, they flow over the surface for a short distance, and then sink rapidly into the sand and gravel, through which they travel as underground water.

Instances of the disappearance of mountain streams are common in the arid regions of the West. Many other cases are found along the Coast Range in California, and indeed they are sometimes noticed in other regions.

Causes of fluctuation of water table. — These may be of natural or artificial character. Natural causes are rainfall, floods, sympathetic tides, thermometric and barometric changes. Artificial causes are dams and pumping.

¹ See Final Report of Chief Engineer, E. S. Nettleton: Ex. Doc. 41, Pt. II, Fifty-second Congress, first session, p. 35; also Trans. Am. Soc. Civ. Eng., Vol. XXX, 1893, pp. 293-329.

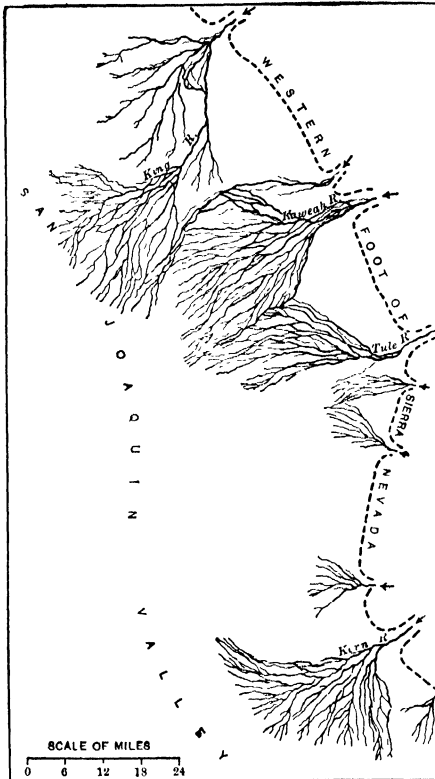

FIG. 140. — Map showing the deltas or fans of disappearing streams as they leave their mountain canyons. (After Slichter, U. S. Geol. Survey, Water Supply Paper, 67.)

Natural causes. — It is a well-known fact that the level of the water table rises during periods of rainfall and sinks during time of drought, the reason for this being self evident, but these changes are not sudden, for it takes the soil a sensible period to absorb the rainfall and transmit it. Consequently the period of lowest or highest groundwater may lag behind that of maximum or minimum rainfall.

The water table on either side of a river normally slopes towards the stream, but if the river rises during flood, the level of the water table may be changed.

“ If the normal level of a river is raised until it stands only a short distance below the surface of adjoining fields, it tends to change the groundwater level to an extent that may affect the neighboring fields. Experience has shown that in light soils the surface of the pool can stand about $2\frac{1}{2}$ feet and in heavy soils about 3 feet below the general level of the fields without causing injury. Small floods, provided they do not overtop the banks, do not affect this limit, as they usually pass off without affecting the groundwater level for more than a short time.”¹

The effect of sympathetic tides is perhaps less easily understood, although the action has frequently been noticed. Thus the water level in some wells in the neighborhood of the seashore seems to oscillate in harmony with the tides, rising with high tide and falling with low tide.²

That this vibration is in sympathy with the tides there can be no doubt, because of the facts just mentioned, and the effect has been noticed in wells from 200 to 300 feet deep, but is usually more noticeable close to the shore than some distance from it.

It is explained by supposing that there is probably a yielding clay layer, which acts as a diaphragm, and responds to the loading and unloading caused by flood and ebb tides.

Along Chesapeake Bay and its tributaries there are many wells which show tidal sympathy, some flowing only at and just after high water.³

While a clay bed often separates the salt from the fresh water, there are cases where the two are connected, and strong pumping on a well near shore may draw in some salt water.

The changes in a well level due to varying thermometric and barometric conditions have been noted at many points. Indeed, the air pressure shows a strong influence, permitting some wells

¹ Thomas and Watt, *Improvement of Rivers*, II, p. 389, 1913.

² Veatch, U. S. Prof. Pap. 44, p. 72, 1906.

³ Sanford, Va. Geol. Surv., Bull. IV, 1913.

to flow during low barometer, but halting the current with high barometer.

In very shallow wells changes in air temperature affect the surface tension of the water. Cold increases the surface tension; hence if some of the groundwater is near enough to the surface (within a few feet) to feel the change, it rises into the partly saturated soil above the water table under the capillary attraction of the soil particles, thus lowering the level of the water in the wells (Sanford).

Artificial causes. — It has been previously stated that the water table slopes towards the valleys, and that the groundwater flows towards them, seeping into the stream channel.

If now a dam is erected across the stream channel, thus ponding the water, the water table will not sink lower than the surface of the pond or reservoir, and the spring discharge from the groundwater may be lessened, due to decreased gradient of the water table (Fig. 141).

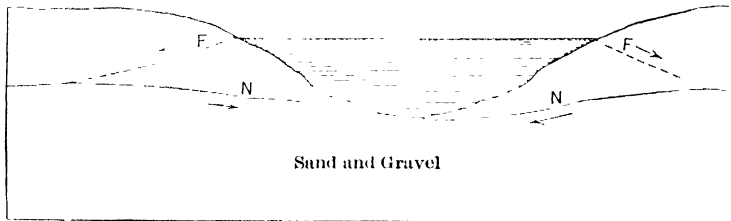

FIG. 141. - Section illustrating conditions governing movement of water away from streams or lakes. N, Normal position of water table; F, position of water table during floods. (From Fuller, Domestic Water Supplies.)

With such conditions the crest flow of the dam may be less than the normal flow of the stream before the dam was erected. Indeed, the dam may be raised to a sufficient height to cause a flow from the reservoir into the groundwater zone.

An interesting case of this was discovered by the engineers of the Brooklyn, N. Y., waterworks at the Hempstead reservoir. Here it was found that the discharge was 5,600,000 gallons per day when the water was maintained at a depth of 14.35 feet, and 8,000,000 gallons when it stood at 4 feet.¹

Leakage from irrigation ditches may cause the water table under a canal to rise (Fig. 143b).

Strong pumping will lower the level of the water table in the ground surrounding a well (Fig. 142), and if the latter is near the sea, brackish

¹ Veatch, U. S. Geol. Survey, Prof. Pap. 44, p. 59, 1906.

or salt water is sometimes drawn in. Pumping water from mines also often affects the level of the water table in the surrounding ground.

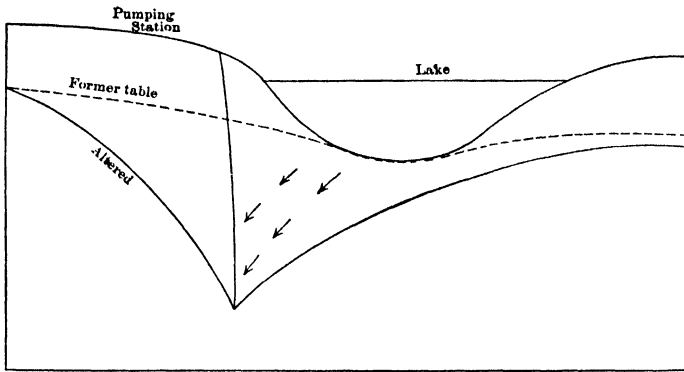

FIG. 142. — Section showing lowering of water table by pumping. (After Veatch, U. S. Geol. Survey, Prof. Pap. 44, p. 72, 1906.)

Digging ditches (Fig. 143a) for drainage and the construction of artificial cuts for railways and highways will cause a local deepening of the water table, if they are cut below the top of the groundwater zone.

Perched water tables. — Above the main water table small bodies of water are sometimes found, which owe their presence to local beds, or basins of clay, or other impervious material. These then hold a supply of water, and their upper limit is referred to as a *perched water table* (Fig. 144). They occasionally serve as sources of supply for shallow wells in a district where the main water table lies so deep as to be reached only by driven wells.¹

It will be seen from the foregoing that in those areas where a perched water table exists, there will be two zones of aëration, one above the main water table and another above the perched one. Figs. 144 and 145 illustrate cases of perched water tables.

Springs

A *spring* may be defined as a natural outflow of water from the ground at a single point, and from a rather definite opening. A *seepage* differs from a spring in that there is no definite opening.

Springs (including seepages) show a wide variation in topographic location. Many emerge in the beds or banks of streams, but their outflow is not always conspicuous. Others issue from the bottom of

¹ Va. Geol. Surv., Bull. IV, 1913; U. S. Geol. Surv., pp. 44, 1906.

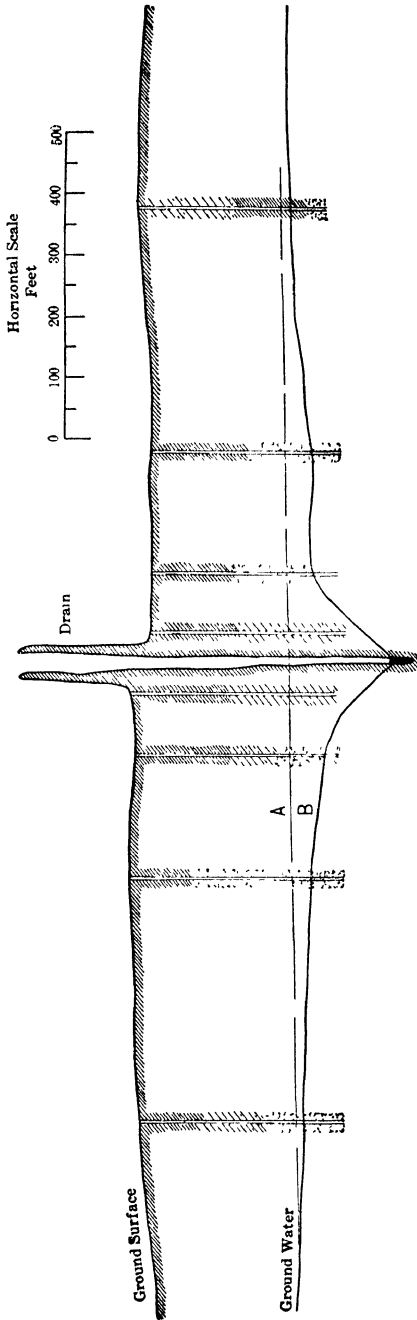

FIG. 143 a. — Section showing lowering of water table by drainage ditches.

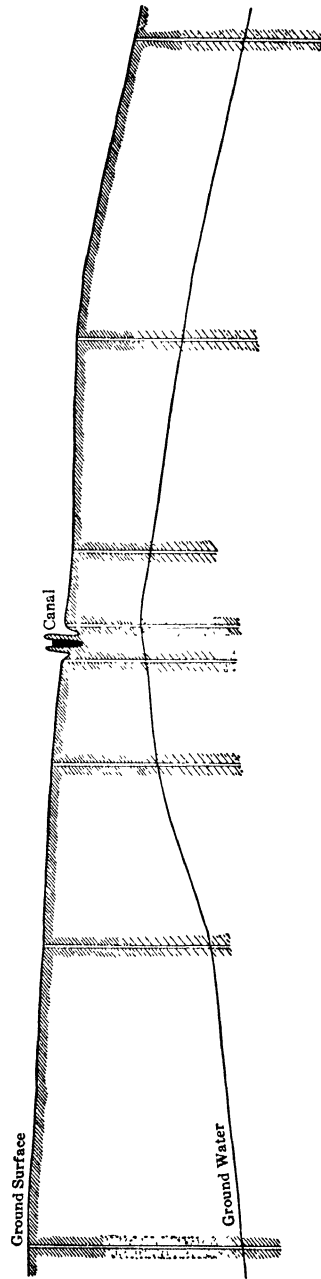

FIG. 143 b. Section showing local rise in water table due to leakage from irrigation canal.

lakes, at the base of bluffs, from the mountain side or even on flat plains.

Their volume of flow is as variable as their location. Those which flow continuously are termed *perennial*, while those which flow only after rains are called *intermittent*.

Spring water may be cold, in which case it is probably of meteoric origin, or it may be hot,¹ and then possibly in

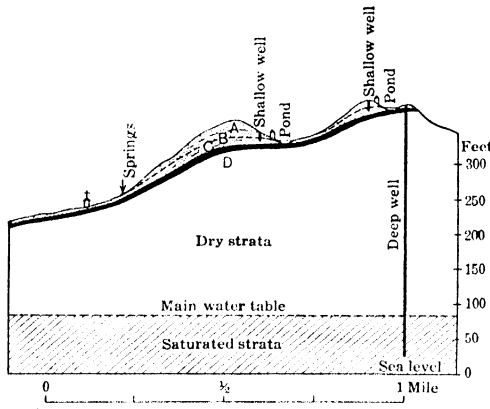

FIG. 144. — Section on Long Island, N. Y., showing a body of perched water. A, unsaturated strata; B, perched water table; C, saturated strata; D, nearly impermeable till. (After Veatch, U. S. Geol. Surv., Prof. Pap. 44, 1906.)

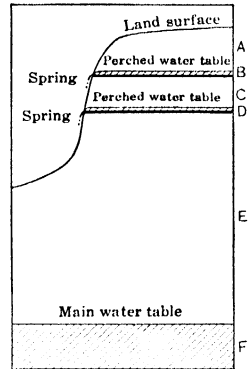

FIG. 145. — Section at Kapapala ranch, Kaw district, Island of Hawaii, showing three zones of aeration, A, C, E, alternating with three zones of saturation, B, D, F. (From Meinzer, U. S. Geol. Surv., Wat. Sup. Pap. 489, 1923.)

some cases is of magmatic origin, or in others represents surface water that has become heated by contact with a mass of uncooled igneous rocks, after which it has risen towards the surface again.

Classification of springs. — The following classification of springs has been suggested by Bryan (Ref. 2).

I. Springs of deep-seated origin. Supplied by juvenile or connate water admixed with deeper meteoric water. Show no seasonal fluctuation nor hydrostatic head. They include waters usually hot and more or less strongly mineralized.

A. Volcanic springs associated with volcanoes and commonly hot.

¹ Descriptions of hot springs may be found in U. S. Geol. Surv. Wat. Sup. Papers 277, 423, 467. Also U. S. Geol. Atl. Fol. 215; Jour. Geol., 1922, p. 425; Econ. Geol. VIII, p. 235.

B. Fissure springs due to fractures extending into the deeper parts of the earth's crust.

II. Waters mainly meteoric moving as groundwater under hydrostatic head. May fluctuate in flow with rainfall. The following subtypes are recognized.

A. Depression springs (Fig. 146) due to the land surface cutting the water table in porous rocks. Topographic location variable. Outflow usually a seepage.

B. Contact springs (Fig. 146) emerging from a porous rock overlying an impervious one. Flow of water due to gravity, and discharge

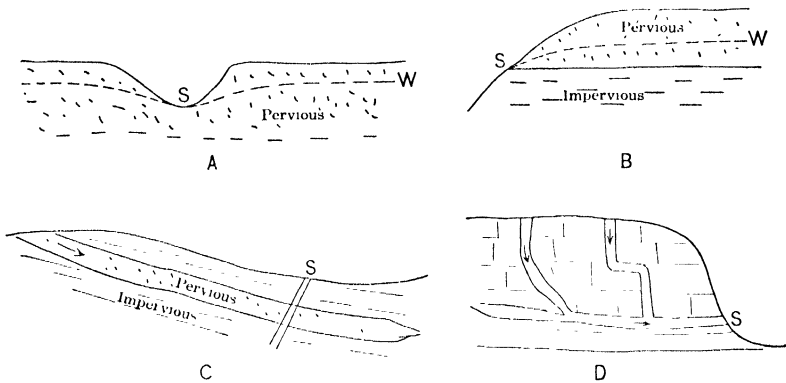

Fig. 146. - Sections illustrating: *A*, depression spring; *B*, contact spring; *C*, artesian spring; and *D*, tubular spring. *S* = spring; *W* = water table.

of water along upper edge of the impervious rock often in the nature of a seepage. The water-tight rock may be a cemented layer in sand, a bed of clay, or hard sandstone, etc.

C. Artesian springs, caused by presence of pervious beds, between impervious materials. It is essential that the porous bed outcrop so as to catch the rain water, and furthermore that it be inclined. Sedimentary rocks, alternating lava flows, tuffs, and gravel or clays may supply the requisite conditions. In some cases the porous bed may be crossed by a fault or joint fracture along which the water rises towards the surface (Fig. 146).

D. Springs in impervious rock, the water moving through openings of secondary origin. Two subtypes are:

1. Tubular springs, in which the water follows more or less tubular openings, such as solution channels in limestone (Fig. 146). The

yield of these may be large and steady. The waters of tubular springs though of variable composition are mostly hard (p. 347), because they commonly issue from limestone.

2. Fracture springs, whose origin is due to water collecting in and flowing from fractures such as joints, planes of bedding, cleavage, or schistosity, or even fault fractures.¹ The flow of such springs is not as a rule large.²

Yield of springs. — The yield of springs including seepages is quite variable. Most of them have a limited discharge and in periods of drought or little rainfall they may dry up.

Sanford in referring to the Virginia Coastal Plain says that "many of the springs fail in every dry summer, and many yield less water after several months of drought, and many show slight difference in volume. These differences represent differences in the magnitude of the fluctuations of the water table.

"Near the edges of high terraces wells go deep for water, and the height of the water in the wells changes but little during the year; springs flowing from the scarps of these terraces have much more uniform flow than those in hollows on terraces away from scarps, where wells are shallow and are full in the spring and dry in the fall. Still there are springs having immediate shallow sources that flow the year through with little reported change in volume. Some such springs evidently are supplied by water that comes through a confined channel so small in proportion to its length that fluctuations of groundwater level are minimized. Springs flowing from crevices in granite in hollows of high terraces are of this class; other springs which show little change in volume though having apparently shallow covers are fed by the water that comes from under a terrace above the one that seems to supply them."

The following figures are of interest as showing the occasionally large discharge of some springs.

Silver Springs, Fla., 368,000 gallons per minute.

Comal Spring, Tex., 147,200 gallons per minute.

Warm Spring, Ore., 116,500 gallons per minute.

Giant Springs, Great Falls, Mont., 400,000,000 gallons per 24 hours.

Crystal Spring, Roanoke, Va., 5,000,000 gallons per 24 hours.

Development of springs. — The quantity of water obtainable from springs may be increased by: (1) Digging trenches or other excavations which will conduct the flow of several seepages or springs into one pool

¹ For springs rising along faults see U. S. Geol. Surv., Wat. Sup. Paps. 277, 365, 423, and 467.

² Some exceptionally large ones occur along Snake River, Idaho, where the collective discharges of springs from basalt in a 40 mile stretch was 5000 cu. ft. per second in 1918 or 2,776,890,000,000 gallons per 24 hours.

or channel and thus prevent loss; (2) enlarging the outlet of the spring; or (3) running one or more tunnels into a hillside in order to intersect the water table and thus not only increase the supply but concentrate the flow towards a single point.

Spring waters while often used as a source of water supply may be at times rather easily polluted, and hence their quality should be carefully investigated. If the water filters from sand or gravel it is usually free from pollution, unless cesspools or buildings are located on the hillsides above the spring. In tubular springs, on the other hand, the water does not pass through any filtering medium and pollution may be carried for a long distance.

Drainage by Wells

Types of drainage. — There are in many regions land areas, sometimes of large size, which are so poorly drained that they cannot be cultivated.¹

Such tracts in the United States, for example, include swamps occupying depressions of the glacial drift in many of our northern states; swampy, flood-plain areas along the larger rivers and the Coastal Plain; and swampy upland areas between streams.

Those lying close to sea level cannot in many cases be made self draining. Others can be freed of their excess of water by: (1) Ditches leading into some stream; (2) tile pipe laid below the surface; and (3) wells.

Drainage by wells consists in putting down a hole in such position that it will take the drainage of the swamp or pond and conduct it to some porous bed of gravel or sand, or into some rock cavern below

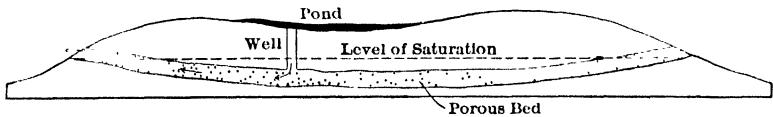

FIG. 147. — Conditions illustrating the drainage of wells into a saturated stratum of lower head. (After Fuller, U. S. Geol. Survey, Water Sup. Pap. 258, 1911.)

(Figs. 147, 148). This method while effective when applicable cannot be used everywhere.

Where swampiness or ponds are due to the water table of the region extending to the surface, drainage by wells is hardly feasible; but where the conditions are due to an impervious layer which holds water

¹ Fuller, Water Sup. Pap. 258, p. 6, 1911.

on the surface, or to a perched water table, then it is often possible to sink a well down to a porous bed or to the main water table and carry off the surface water.

Of the unconsolidated surface deposits sand and gravel form the most efficient drainage material. Clay although very porous is so fine-grained that the water passes through it but slowly. Till, being

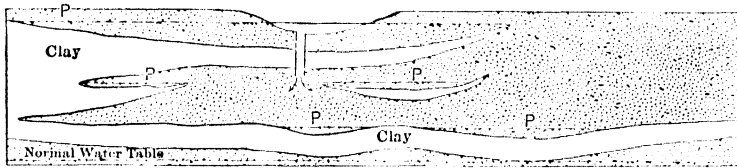

FIG. 148. — Conditions encountered by wells sunk through perched water tables. (After Fuller, U. S. Geol. Survey, Water Sup. Pap. 258, 1911.)

composed of a heterogeneous mixture of clay, sand, pebbles, and boulders of glacial origin, may vary in its porosity, but is usually fairly porous.

Consolidated rocks vary in their porosity. Sand and gravel are said to retain porosities of from 10 to 15 per cent even after consolidation, and while they are thus capable of holding considerable water, it does not flow into them as readily as into uncemented materials. Fuller states that drainage into sandstones is said to have been successful

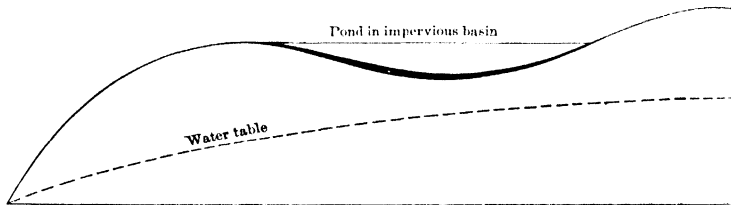

FIG. 149. — Pond held in impervious basin above the water table. (After Fuller, U. S. Geol. Survey, Water Sup. Pap. 258, 1911.)

in Michigan, and that several wells in St. Paul and Minneapolis carry refuse into the porous St. Peter sandstone. Limestones will take up considerable water in joint and stratification planes, and if they contain solution channels their drainage capacity is still greater.

Application of drainage by wells. — In the drift-covered area of the northern states, especially in Indiana, Minnesota, Wisconsin, and Michigan, there are numerous marshes, which can be successfully drained by wells if situated on higher ground. In Michigan the individual

tracts thus drained vary from 10 to 60 acres. Those undrained areas lying on low ground are not, as a rule, amenable to drainage by wells.

Many of the ponds in the states mentioned above can, however, be drained by wells. This has been done by driving the well either into beds of sand and gravel in the drift or into the St. Peter sandstone. In Georgia and Florida the limestone often serves as a drainage sump. At Quitman, Ga., a well is said to have drained off 1,500,000 gallons from a pond in a few hours. The same use is made of limestone in parts of Virginia, Kentucky, Tennessee, Indiana, and other states. Cellars have been drained by wells at Minneapolis, St. Paul, Hampton, Blooming Prairie, Bricelyn, Geneva, and other places in Minnesota. Industrial wastes are also disposed of in this way at some localities. In Kentucky, Georgia, Florida, and other states sewage is occasionally poured into them, and Fuller states that public or private sewage wells are in operation at Georgetown, Ky., and at Orlando, Ocala, Live Oak, Gainesville, and Lake City, Fla.

Pollution by drainage wells. — Polluted water flowing into sands and gravels will probably not do any harm beyond a few hundred feet, but in limestone passages the contaminating materials may be carried a long distance.

The use therefore of drainage wells for carrying off sewage or industrial wastes is often exceedingly dangerous, and should in the opinion of many be prevented by legislation, especially in those areas where it is likely to contaminate water supplies.

Artesian Water

Definitions. — The term artesian water is unfortunately not used always to designate the same type of subsurface water accumulation. It may be well therefore to define exactly this and several other terms, following the usage of the United States Geological Survey.

Artesian water is groundwater that is under sufficient pressure to rise above the zone of saturation. *Artesian well* is a well that taps artesian water. *Aquifer* is a rock or formation that is water-bearing. *Artesian aquifer* is one containing artesian water. *Artesian basin* is a geologic structural feature or features containing water under artesian pressure.

Hydrostatic pressure of groundwater is usually due to the weight of water at higher levels in the same zone of saturation (Meinzer), but the pressure in a given aquifer differs from point to point, decreasing in direction of movement.

Hydrostatic level or *static level* of water, at a given point in an aquifer, is that level passing through the top of a column of water that can be supported by the hydrostatic pressure of the water at that point. It is the level to which water will rise in a well under its full pressure head.

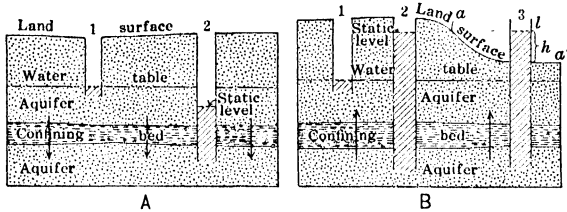

FIG. 150. — Sections showing hydrostatic pressure in aquifers and wells. In *A* the lower aquifer has subnormal head; its piezometric surface is below the upper surface of the zone of saturation, the resultant hydrostatic pressure on the confining bed is downward, and the bed may be called a negative confining bed. Both wells are non-artesian. The water in the upper aquifer is semiperched — it belongs to the same zone of saturation as the lower aquifer. In *B* the lower aquifer has artesian head, its piezometric surface is above the upper surface of the zone of saturation and in some places above the land surface, the resultant hydrostatic pressure on the confining bed is upward, and the bed may be called a positive confining bed. No. 1 is a non-artesian well, No. 2 a subartesian well, and No. 3 a flowing well. The static level of the water in the lower aquifer at the intake of well No. 3 is at l , and its pressure head with reference to the land surface is the vertical distance h . aa' is an area of artesian flow. (After Meinzer, U. S. Geol. Surv., Wat. Sup. Pap. 494.)

Piezometric surface of an aquifer is an imaginary surface that everywhere coincides with the static level of the water in the aquifer. An aquifer may have more than one piezometric surface, if the water from different depths in the aquifer rises to different levels.

An *isopiestic line* of an aquifer is a contour of the piezometric surface of the aquifer.

The *pressure head* of water at a given point in an aquifer is its hydrostatic pressure expressed as the height of a column of water that can be supported by the pressure. If we say that at the surface the pressure head is 25 feet, it means that the pressure is sufficient to lift the water in a tightly cased well to a level 25 feet above the surface.

An *artesian flowing well* is one whose water is lifted by hydrostatic pressure above the land surface at the well.

An *area of artesian flow* is a land or water surface which lies below a piezometric surface, or, in other words, an area in which the water of

some underlying aquifer is under sufficient pressure to rise above the surface.

Groundwater is said to have *artesian, normal, or subnormal pressure* or *pressure head*, according as its static level is above the upper surface of the zone of saturation, at this surface, or below it. (Fig. 150.)

Spaces in rocks. — Artesian water contained in rocks may be held in interstices of diverse size, origin, and shape.¹ These spaces may be either of original or secondary character, as follows:

Original interstices consisting of (1) spaces of variable size between the grains of sedimentary rock; (2) spaces in igneous rocks, including interstices between the grains, and lava vesicles.

Secondary interstices include (1) joints, faults, breccia or other openings due to dynamic disturbances; (2) solution openings, and (3) openings of minor importance produced by weathering, recrystallization, etc.

These cavities vary greatly in size, from supercapillary to subcapillary.

A *capillary* interstice with respect to water, is one which is small enough for water to be held in it at a considerable height above the level at which it is held by hydrostatic pressure. A *supercapillary* space is so large that water will not be held in it far above the level at which it is held by hydrostatic pressure. A *subcapillary* interstice is theoretically so small that, at least in some parts, the attraction of the molecules of its walls extends through the entire space which it occupies. (Meinzer.)

Water capacity of rocks. — In view of the variable character of the water-holding cavities it is somewhat difficult to estimate accurately the water capacity of a rock. Moreover any one kind of rock, such as a sandstone, may show wide variation in porosity.

The porosity of different materials (Ref. 9) ranges from 1 to 50 per cent. Porosities of greater than 40 per cent are rare except in soils and unsettled deposits. A porosity of greater than 20 per cent may be regarded as high, 5 to 20 per cent as medium, and under 5 per cent as low.²

There is so much variation in porosity of rocks of the same kind that specific data are of little general value.

This fact may be more readily appreciated, when one considers that in a sedimentary rock, for example, the porosity may depend on: (1) Shape and arrangement of constituent particles; (2) degree of assortment of particles; (3) amount of cementing and compacting since deposition; (4) removal of mineral matter by solution; and (5) fracturing of rock.

¹ Fuller, U. S. Geol. Surv., Wat. Sup. Pap. 319, 1908.

² For methods of determining porosity see Meinzer, U. S. Geol. Surv., Wat. Sup. Pap. 489, p. 11, 1923.

Amount of groundwater. — The amount of water in the earth's crust is of great interest to those seeking deep supplies, as well as to those interested in the circulation of underground water in its relation to mining. Probably no other question is so frequently asked in the field as that in regard to the water zone which most people suppose to exist somewhere below the surface and which they invariably believe will always be found if a well only "goes deep enough" (Fuller).

Distinction should be made between *free* water which occupies fractures, pores, and other openings in rocks, and *chemically combined* water which forms a part of some minerals. Also *free* water should be distinguished from *available* water, for certain materials like clay are capable of holding much water but give up only a small quantity of it. As Fuller remarks a rock may hold 35 or 40 per cent of water and yet yield almost none to a pump.

In estimating the total amount of free water in the earth's crust, Fuller emphasizes the most important factors in the problem to be (a) porosity, (b) thickness of sediments, and (c) saturation.

The porosity of rocks varies widely as shown in the following table.

POROSITY OF ROCKS¹

Rock.	Authority.	Number of tests.	Minimum.	Maximum.	Average or mean.	Remarks.
Granite, schist, and gneiss	Buckley	14	0.019	0.56	0.16	Wisconsin rocks only.
Granite, schist, and gneiss	Merrill	22	0.37	1.85	1.2	
Gabbro	Merrill	1	0.84	
Diabase	Merrill	2	0.90	1.13	1.01	
Obsidian	Delesse	1	0.52	Specific gravity not given.
Sandstone	Buckley	16	4.81	28.28	15.89	Mainly brownstones.
Sandstone	Merrill	3.46	22.8	10.22	
Quartzite	Merrill	1	0.8	
Quartzite	Geikie	0.21	Specific gravity not given.
Slate and shale	Delesse	2	0.49	7.55	3.95	
Limestone, marble, and dolomite.	Buckley	11	0.53	13.36	4.85	Wisconsin rocks only.
Chalk	Geikie	53	Specific gravity not given.
Oolite	Merrill	8	3.28	12.44	7.18	Indiana stone only.
Gypsum	Geikie	1.32	3.96	2.64	Specific gravity not given.
Sand (uniform)	King	Many	26	44.7	35	Theoretical porosity; actual results similar.
Sand (mixture)	King	Many	35	40	38	
Clay	King	Many	44	47	45	
Clay	Geikie	53	Specific gravity not given.
Soils	U. S. Dept. Agr.	Many	45	65	55	Common range.

¹ Fuller, Water Supply and Irrigation Paper No. 160, U. S. Geol. Survey, 1906, p. 61.

Summarizing the porosity, Fuller gives the following values to the different kinds of rock. Sandstones, 15 per cent; shales, 4 per cent; limestones, 5 per cent; and crystalline rocks, 0.2 per cent.

After a discussion of the saturation factors, the same author sums up the results as follows:

Average percentage of the theoretical capacity of stratified rocks actually taken up by water. 37

Average percentage, etc., of igneous rocks actually taken up by water. 50

The average thickness of the sedimentary rocks is taken as 2600 feet, and that portion of the crystalline rocks in which water can occur as 15,375 feet.

These various factors affecting the computation of the volume of underground water are tabulated below:

FACTORS IN COMPUTATION OF VOLUME OF UNDERGROUND WATERS

Rocks.	Thickness, feet.	Porosity, per cent.	Saturation factor, per cent.	Volume occupied by water, per cent.
Sandstone	1,040	15 0	37	{ 5 25 { 1 48 { 1 75
Shale	1,300	4 0		
Limestone	260	5 0		
Crystalline rocks ¹	15,375	0 2	50	.1

¹ Average per cent of rock occupied by water, 0.52.

On the basis of these factors Fuller estimates the total free water held in the earth's crust to be "equivalent to a uniform sheet over the entire surface with a depth of little less than 100 feet (96 feet)."¹

Previous estimates of the amount of subsurface water by others are: Delesse,² 1,175,089 million cubic meters or 1,530,000 million cubic yards, equivalent to a sheet of water over 7500 feet thick surrounding the earth. Slichter³ computed the amount to be equivalent to a uniform sheet of from 3000 to 3500 feet in thickness. Van Hise⁴ estimates the amount to be sufficient to cover the earth's surface to a depth of 69 meters or 226 feet. Chamberlin and Salisbury,⁵ assuming the average porosity to be 2½ per cent, estimate the amount of subsurface water to be equivalent to a layer 800 feet deep over its entire surface, and of an assumed porosity of 5 per cent, a layer 1600 feet deep.

Permeability and water-yielding capacity. -- The hydraulic permeability of a rock is its capacity for transmitting water under pressure. (Ref. 9.)

The permeability of a rock will be influenced by gravity which is operative only in large cavities and adhesion which is effective only in small openings. Consequently the capacity of a rock to transmit water under pressure will depend on the size of its pores.

But even if the water capacity of a rock be great, all of the water will not be available for recovery through wells. We may consequently distinguish two kinds of free water in rocks: (1) *Available* or *gravity groundwater* and (2) *unavailable* or *attached groundwater*.

Two terms used to express these conditions are: (1) *Specific yield* which refers to the percentage of total volume of the rock occupied by gravity ground water in a saturated rock, and (2) *specific retention* which refers to the percentage of rock volume occupied by attached ground water.

¹ Fuller, Water Supply and Irrigation Paper No. 160, U. S. Geol. Survey, 1906.

² Bull. Geol. Soc. France, 2d ser., XIX, 1861-62.

³ Wat. Supply Paper, No. 67, 1902.

⁴ U. S. Geol. Surv., Mon. 47, 1904.

⁵ Chamberlin and Salisbury, Geology, Vol. I, p. 206.

Thus if 100 cubic feet of rock when drained yields 8 cubic feet of water its specific yield is 8 per cent. If after draining it retains 13 cubic feet the specific retention is 13 per cent.

It is obvious that the quantity of water which a rock yields depends on its specific yield and not on its porosity. The specific yield of a gravel may nearly equal its porosity, while the specific yield of a clay may be nearly zero.

Water is naturally yielded more rapidly by coarse than by fine materials.¹

Two interesting and contrasted cases may be quoted from Fuller (Ref. 3).

Granite will on the average hold about .3 quart of water per cubic foot in the pore spaces between its grains. Within a radius of 500 feet from a 300-foot well the quantity of water stored would be approximately 17,600,000 gallons. The pore spaces are however so small that hardly a drop of this would be yielded to wells, that which is obtained coming from joints (Fuller.)

As contrasted with this we may take a sandstone of open character having 25 per cent pore space between the grains. About three-fifths of this water would be yielded to wells, or about 4.5 quarts per cubic foot, and a bed 10 feet thick covering one acre would hold 490,000 gallons (Fuller).

Rate of movement of subsurface water (Ref. 9).— The rate of movement is influenced by the size and arrangement of the grains of the rock. Thus in the case of fine rounded grains the pores are of capillary size, and the frictional resistance to the movement of the water is great.

In coarse sands, the spaces being larger, the water can move more freely. With mixed grains we have intermediate conditions. A coarse sand is said to transmit water one hundred times more freely than a fine sand, and clay, although having a high absorptive capacity, has a transmission rate of practically zero.

The rate of movement is also controlled by frictional resistance and difference in elevation between two given points in the course which the water is following.

On the south shore of Long Island measured velocities in the Coastal Plain deposits range from 15 inches to 12 feet per day.²

¹ For methods of determining specific yield see Meinzer, U. S. Geol. Surv., Wat. Sup. Pap. 489, p. 67, 1923.

² Slichter, U. S. Geol. Survey, Wat. Sup. Pap. 140, p. 67, 1905.

Requisite conditions of artesian flow.— The requisite conditions of artesian flow may be stated as follows: (1) Adequate source of water supply; (2) a retaining agent offering more resistance to the passage of water than the well opening; and (3) an adequate source of pressure.

That portion of the surface where the water-bearing bed receives its supply is known as the *collecting area*. It may be near to, or far from, the well, and of either small or great extent.

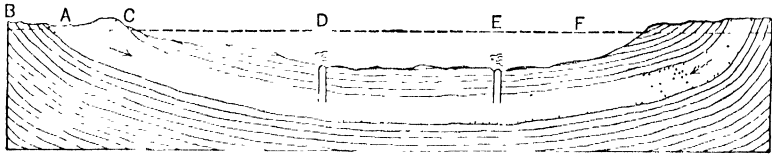

FIG. 151. — Section of an artesian basin. A, porous stratum; B, C, impervious beds below and above A, acting as confining strata; F, height of water level in porous beds A, or, in other words, height in reservoir or fountain head; D, E, flowing wells springing from the porous water-filled bed A. (From Fuller, U. S. Geol. Survey, Bull. 319, 1908.)

The old idea was that the conditions necessary for the accumulation of a supply of artesian water were those shown in Fig. 151, and while it may gather under these conditions they do not by any means represent the only favorable type of structure.

Artesian Water in Stratified Rocks

The simplest and most favorable structure for artesian accumulation is that which is sometimes found in stratified rocks. Thus we may have inclined beds of permeable rock capped by a bed of impermeable or but slightly permeable character (Fig. 151).

Water seeping into the outcrop of the water-bearing layers on the surface may flow down them either in pores, or in the pores and joints together, and accumulate in this underground reservoir in sufficient quantities to yield an abundant supply.

Several simple cases of this type of accumulation are shown in Figs. 151, 153, 159, and 160. In all of these the water follows the water-bearing bed and accumulates in it under pressure.

If now a well is sunk to the aquifer, the water rises in the tube and flows out at the surface, provided there is enough head, the latter being

governed primarily by the difference in elevation between point of intake and mouth of well.

Some porous stratified rocks like the St. Peters sandstone of the central states may underlie thousands of square miles, and show widespread porosity. Others may show lateral gradations and hence vary from coarse to fine and even low porosity.

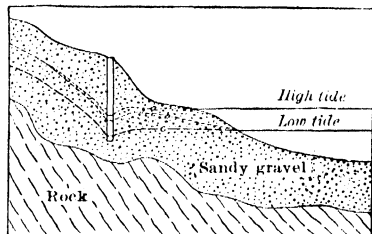

FIG. 152. — Section showing relation of tide to level of water table. (After Ellis.)

Gravels and conglomerates. — Gravel is the best kind of formation to yield water not only on account of its high porosity but also because of the large size of its interstices. Meinzer states that in the United States it supplies most of the strong

wells and furnishes more water to wells than all other materials taken together. A well only a foot in diameter ending in a good bed of gravel may supply more than 1000 gallons per minute.

Clean gravel is deposited chiefly by large swift streams. It is common in the outwash plains from glaciers, and many thick deposits are found in the intermontane valleys of the western states.

Most of the water supply for the city of Brooklyn, N. Y., was formerly obtained from the gravel outwash plains of the continental glacier on Long Island.

In the San Bernardino valley of California a group of three wells, all less than 2000 feet deep, in 1892 gave 4000 gallons per minute each.

Gravels may of course vary in texture, and some may be more or less cemented.

Hard conglomerates are often so cemented as to yield water only from the joints.

Sands and sandstones. — These rocks rank next to gravel in importance as sources of subsurface water. They are sometimes of considerable thickness and underlie many hundreds of square miles.

Among the artesian systems of this class may be mentioned the Atlantic Coastal Plain province, the region of the High Plains east of the Rocky Mountains, and the Upper Mississippi Valley.

A sand or sandstone formation is often more continuous and widespread than a bed of gravel or conglomerate, but compares unfavorably with gravel in having smaller interstices and therefore conducting less

water as well as giving it up less readily to wells. It may have the further disadvantage of containing smaller particles of sediment which are more readily carried into wells. Grain size is therefore of importance and uniformity of texture is equally so. A very fine-grained sand or

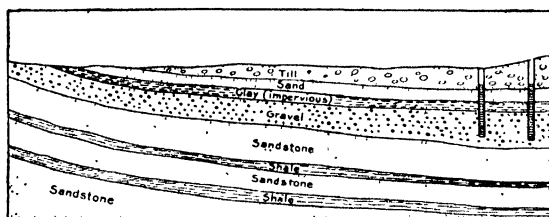

FIG. 153. — Section in water-bearing gravel with intake too low to cause water to rise to the surface. (After Ellis.)

sandstone, or one containing clay between the grains, would not make a good aquifer.

A good sandstone well may yield several hundred gallons per minute.

Limestones. — Limestones are not such important sources of artesian water as sandstones, but may yield a supply under three sets of conditions.

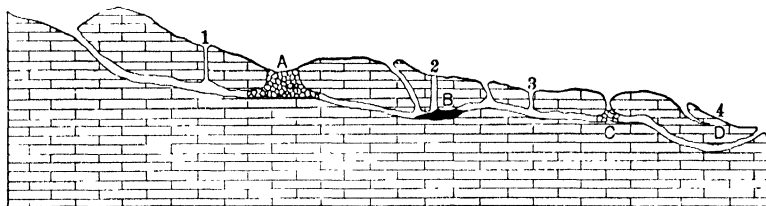

FIG. 154. — Section illustrating conditions of flow from solution passages in limestone. A, brecciated zone (due to caving of roof), serving as confining agent to waters reached by well 1; B, silt deposit filling passage and acting as confining agent to waters reached by well 2; C, surface debris clogging channel and confining waters reached by well 3; D, pinching out of solution crevice resulting in confinement of waters reached by well 4. (After Fuller, U. S. Geol. Survey, Bull. 319, 1908.)

1. When limestone beds are included between shales or other impervious rocks, the water may accumulate in them along the joint and stratification planes. This type of occurrence is known, for example, in southwestern Ohio, Indiana, Iowa, and parts of Texas. A modification of this is the occurrence of jointed limestone under a capping of glacial

drift, so that the water absorbed by the latter percolates into the limestone.

2. If a series of solution channels extend through a limestone from a higher to lower level, the water will follow them. If, however, these become clogged at some point, as by silt, or by a collapse of the roof, the water backs up behind the obstruction, and a well driven down into the cavity filled with water may yield a flow (Fig. 152). At Lawrenceburg, Ky., a supply of water is obtained from channels and caverns in the Lexington limestone, the daily supply from four wells being given as 400,000 gallons.¹

3. Some of the younger limestone formations are very porous and may have abundant interstices. The older ones are usually so dense as to have little or no original pore space.

There is a certain amount of uncertainty regarding a supply of water from limestone. One well may get water, while another one drilled near by may yield none, because it has missed the solution channels.

Aside from serving as a source of artesian water, limestones may contain tubular springs, and according to Meinzer there are 15 to 20 known in the United States which yield more than 100 cubic feet per second. Some are also known in Western Canada.

Clay. — This material on account of its very fine texture and abundance of colloidal matter is of no value as a source of artesian water. It occasionally yields water to dug wells if these happen to strike gravelly or sandy lenses in the material.

Shale. — This is a poor water bearer because of its dense character, and any water obtained from wells must come from joints or bedding planes.

Glacial drift. — Glacial deposits consist of sand, gravel, silt, clay, or a mixture of these. The first two not only have a high water capacity, but permit a rather free percolation of water, and under favorable circumstances may yield flowing wells. Clays and silts are less productive.

When artesian water is found in glacial drift it is usually because pockets of sand or gravel are surrounded by less permeable material, as clay, but owing to the changeable character of the drift when traced from point to point, it is rare to find the individual water-bearing materials extending for any great distance. Many small artesian basins are, however, often thickly scattered over an area, and in Michigan, for example, there are hundreds of them.

¹ Matson, U. S. Geol. Surv. Wat. Sup. Pap. 233, 1909.

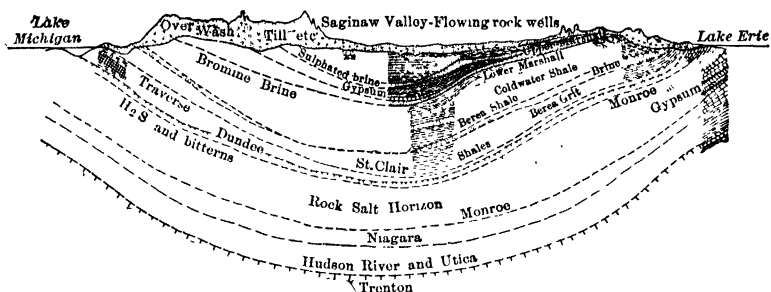

FIG. 155. — Section across Michigan, showing cover of glacial drift yielding flowing wells. (After Lane.)

Wells in glacial drift are often shallow, usually 50 to 150 feet, and the intake is often not far from the well and but slightly elevated above it. Neighboring wells may interfere to a marked degree.

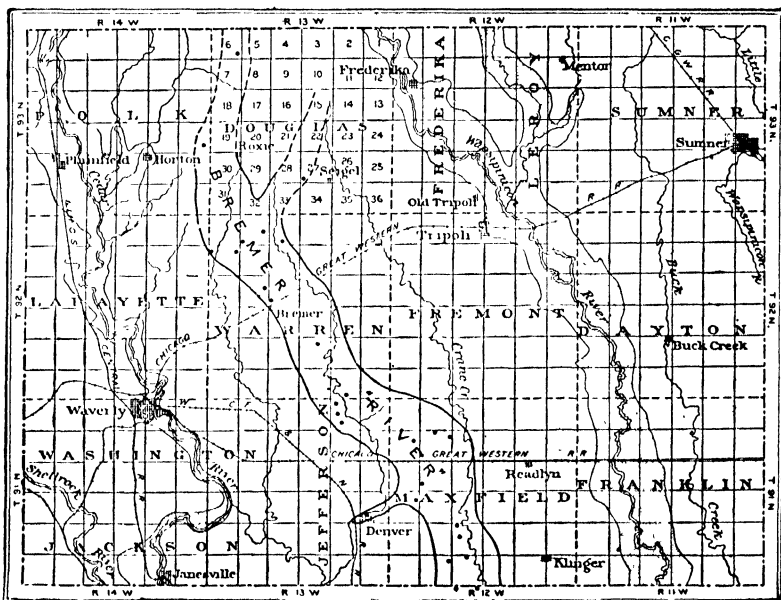

FIG. 156. — Map of artesian field of Wapsipicon River, Iowa, and of buried channel of Bremer River. (Ia. Geol. Survey.)

Some communities of moderate size obtain their water supply from a series of wells driven in the glacial drift, and yet it is not safe to assume that the volume of flow will be the same in two drift-covered regions of equal rainfall. This is because the structure of the drift in the two areas

may be totally unlike. In some drift-covered regions pre-glacial river valleys (Fig. 156) are filled with drift, and a variable but good supply of water can usually be obtained from this filling.

Till is of low porosity and low specific yield, and even dug wells in it are not as a rule very productive.

Artesian Water in Crystalline Rocks

It is believed by many that very little water is to be obtained from granite and similar rocks, because they are very dense and solid, and hence appear to offer few cavities for the accumulation of water.

This assumption is no doubt due to the fact that but little drilling for water in these rocks was attempted until recent years, and hence the possibilities of subterranean accumulation in them were not understood.

Engineers, however, who have had occasion to tunnel through such materials and encountered strong flows of water, have no doubt come to the conclusion that crystalline rocks are far from dry. But one

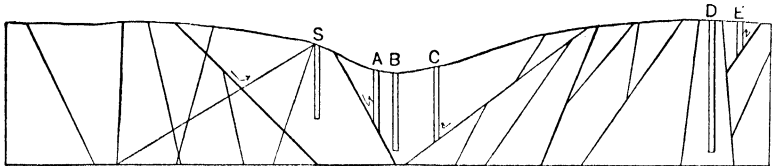

FIG. 157. — Section illustrating artesian conditions in jointed crystalline rocks without surface covering. A, C, flowing wells fed by joints; B, intermediate well of greater depth between A and C, but with no water; D, deep well not encountering joints; E, pump well adjacent to D, obtaining water at shallow depths; S, dry hole adjacent to a spring, showing why wells near springs may fail to obtain water. (From Fuller, U. S. Geol. Survey, Bull. 319.)

feature that has no doubt impressed itself on those who have sought an artesian supply in the crystalline rocks, is that one well may be a success while a near-by one is a complete failure.

The rocks included under this type are igneous ones such as granite, diabase, basalt, rhyolite, etc., or metamorphic rocks such as gneiss, schist, and slate. These vary mineralogically and even structurally, but they agree in the absence of definite stratification planes, and in having low porosity, often less than one per cent. They may however be traversed by numerous joints, or in some metamorphic rocks by planes of schistosity, and it is in such fractures that practically all the water accumulates. (Fig. 157.) The joints may be horizontal, vertical, or irregular, and are more abundant near the surface than deeper down.

The water filters in usually along the steep joints, and may collect in these or the horizontal ones. Since, however, most joints are rather narrow, the amount of water likely to be held in joint fissures is very moderate, and wells yielding as much as 90 gallons per minute are the exception rather than the rule.

Joints in crystalline rocks are usually very irregular, and hence the success of a well is largely a matter of chance (see Fig. 157). That is, it depends on whether the drill hole strikes a water-bearing joint.

Some wells may strike several water-bearing joints and thus get an increased flow, but this may be lost if the hole is driven still deeper and strikes an open crack in which the water is lost.

F. G. Clapp¹ endeavored to obtain some data on the success of wells in crystalline rocks. He found, for example, that in the case of wells drilled in Maine granites, 87 per cent were successful, but that out of 72 producing wells, only 3 yielded over 50 gallons of water per minute. His figures also show that by far the greater number of wells drilled in granite to a depth of over 50 feet do not exceed 100 feet.

The data also show that out of 40 wells drilled to a depth of between 50 and 100 feet, 95 per cent were successful, but the percentage of successful wells decreased with depth.

Ellis has also tabulated the records of a number of wells drilled in different kinds of crystalline rocks in Connecticut, the results of which are given in the following table:

YIELD OF WELLS IN VARIOUS TYPES OF CRYSTALLINE ROCKS IN CONNECTICUT

Material.	Depth of surface covering.		Depth in rock.		Total depth.		Yield.	
	No. of records.	Feet.	No. of records.	Feet.	No. of records.	Feet.	No. of records	Gal. per min.
Granite	45	20 6	45	100 5	54	122 5	35	13.0
Gneiss	69	16 3	70	112 6	73	131 4	50	12.3
Quartzite-schist	3	32 5	3	411 0	3	443 5	3	7.25
Schist other than quartzite	23	13 7	23	96 0	23	109 7	16	13 9
Granodiorite	15	24 1	16	138 5	19	156 6	13	33.0
Phyllite (slate)	5	14 4	5	80 2	5	93.8	5	very poor

While this table shows that the granodiorite in Connecticut yields more water than granite, gneiss, or common schist, it cannot be assumed that the same kind of crystalline rocks will be the most important source of water in other regions.

¹ U. S. Geol. Survey, Water Sup. Pap. 223.

Clapp concludes that contrary to the popular belief that the quantity of water will increase with depth, experience has shown that there is a far greater chance for success in wells shallower than 100 feet, while below 200 feet the chance for success decreases rapidly.

Sanford (Ref. 55) gives the data for 33 wells in the Richmond, Va., area of which six have a depth of 250 feet or less, while the others

range from 250 to 900 feet.

He says: "(1) Of the deep wells in crystalline rocks 2 were dry or gave too little water to be of use; 7 gave, estimated or measured, 5 to 25 gallons; 16, from 26 to 100; 4, from 101 to 200; and 2, over 200 gallons per minute. Or, 5 gave 5 gallons or less, making the proportion of commercially successful wells over 80 per cent. (2) Of the 22 more successful wells, 15 or nearly 70 per cent went less than 500 feet into 'granite' and 1 went less than 200 feet. (3) Of the 17 wells yielding 50 gallons per minute, or over, 6 were on high ground, 6 on

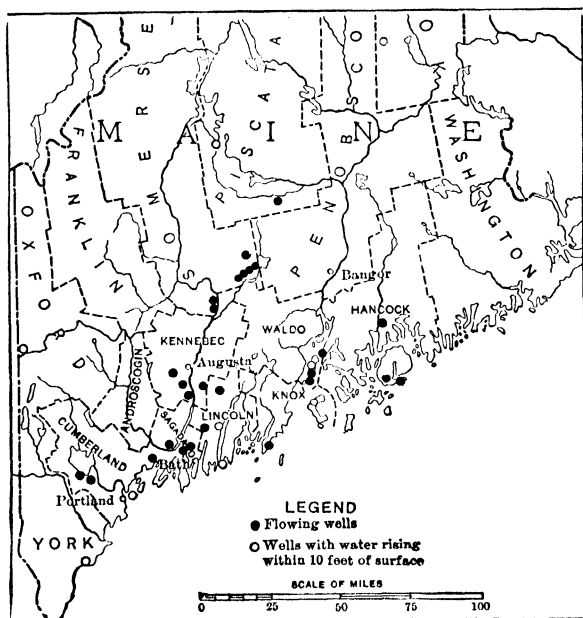

FIG. 158. — Section illustrating conditions of flow from vesicular trap. A, vesicular zone feeding well 1. (From Fuller, U. S. Geol. Survey, Bull. 319, 1908.)

low ground, and 5 on hillsides, showing that yields bear little relation to the situation of wells."

Many wells sunk in crystalline rocks are not flowing at the surface, for the head is usually slight. The water, however, in most cases is of excellent quality, but those sunk close to the seashore may become contaminated by an inflow of salt water.

Among the volcanic rocks, basalt is an important aquifer, especially in the northwestern states (Ref. 9) and Hawaiian Islands.¹ The water is contained in large joint openings and other cavities, as well as in zones of vesicular lava and fragmental material. All basalts, however, do not

¹ Stearns and others, U. S. Geol. Surv., Wat. Sup. Pap. 616, 1930; Palmer, Rept. Honolulu Sewer and Water Commission for 1927.

yield an abundant water supply, those of the Lake Superior region and the eastern United States for example being of this type, because they are much older geologically and hence considerably metamorphosed.

The more siliceous volcanics have fewer large openings, and are less favorable as sources of artesian water.

Schists may carry some water in small openings, but on account of their relatively soft character, the water-bearing fractures are apt to become closed at rather shallow depths. Slate is also an unsatisfactory aquifer, although it has served as a source of water supply occasionally as at Manhattan, Nev.,¹ in Maine,² and Connecticut.³

Factors Affecting Artesian Water Supplies

As has been noted by Meinzer (Ref. 9) a geologic section serves as an important clue to the groundwater conditions of a locality. The character, thickness, succession, and structure of the underlying formations give the most important data as to the existing aquifers and depths at which they can be tapped. Well records are especially valuable in a study of groundwater conditions.⁴

Several aquifers in same section. — In any extensive series of stratified rocks the same kind of rock at different depths below the surface

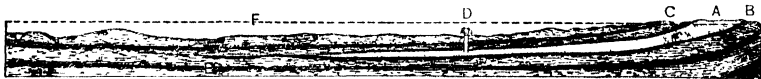

FIG. 159. — Section illustrating the thinning out of a porous water-bearing bed. A, inclosed between impervious beds, B and C, thus furnishing the necessary conditions for an artesian fountain D. (After Chamberlin.)

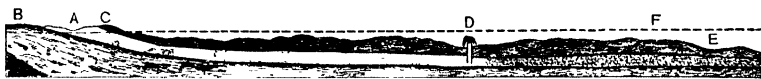

FIG. 160. — Section illustrating the transition of a porous water-bearing bed, A, into a close-textured, impervious one. Being inclosed between the impervious beds, B and C, it furnishes the conditions for an artesian fountain at D. (After Chamberlin.)

may be found occurring more than once, and so it happens that in an artesian province we may find more than one water-bearing sandstone,

¹ U. S. Geol. Surv., Wat. Sup. Pap. 423.

² Ibid. No. 223 and 258.

³ Ibid. No. 167 and 232.

⁴ For a detailed discussion of the methods of correlating well sections, examination of well samples, and effect of structure on artesian water accumulation see Meinzer, Wat. Sup. Pap. 489, p. 159 *et seq.*

or both sandstones and limestones may be found in the section, all of them yielding water.

It should be remembered, however, that the water from these different beds is by no means always of the same quality. One may yield good water, while that from another bed above or below may be highly mineralized and unfit for use.

Thus at Cedar Rapids and McGregor, Ia., the first wells drilled encountered salty and corrosive waters in the Cambrian sandstones, consequently, wells drilled later in these towns were stopped before they reached the horizons at which the poor waters were obtained.¹

If a well is not properly cased, or the casing becomes pitted by corrosion, water from several different beds will flow into the same well. This sometimes accounts for a good water turning bad after the well has been in operation for a time.

Irregularities of artesian supply. — The pressure of a well will depend on the difference in level between the point of intake and the mouth of the well, the friction between water and rock, and porosity. The volume of flow will depend on pressure, quantity of supply, and freedom of movement of the water through the rock pores.

In any aquifer there may be dry areas, because of locally, dense spots, and hence a well drilled to these will be a failure. Or, a porous sandstone may grade into an impervious shale, so that if two wells are sunk to the same bed, the one striking the sandy portion will yield a flow, while that penetrating the shaly part will give none.

The exhaustion of wells may be caused by: (1) Exhaustion of water in reservoir, because it is drawn up faster than it is replenished; (2) clogging of the pores of the rock by silt or clay; (3) interference by neighboring wells; and (4) improper casing, which either allows the well to cave in or permits the water to leak away into porous strata nearer the surface.

The artesian wells of Denver, Colo., are often referred to as an interesting case of exhaustion. A few years after the discovery of this basin in 1884 there were about 400 wells sunk in an area about 40 by 5 miles. No general decrease was noted up to 1886, but between 1888 and 1890 there was a continuous decrease in the flow of the city wells, and by the end of the latter year many of them had to be pumped while others in the area were abandoned.

The cause of the exhaustion was not considered to be insufficient rainfall, but rather the low porosity and consequent low-transmission power of the aquifer.

¹ Ia. Geol. Survey, XXI, 1912, p. 150.

Interference. — It is sometimes noticed that the drilling of additional wells in a region affects the head or yield of those already in operation. This is very likely to happen if the water-bearing bed is thin, and if the water does not flow into the bed fast enough to replace that drawn out. Sanford in describing the artesian water supply of the Virginia Coastal Plain says: "At Colonial Beach the first artesian wells found water at a depth of about 200 feet that rose fully 20 feet above tide level, or above the surface at the highest points in town. Possibly 200 wells have been drilled in an area $1\frac{1}{2}$ miles long and half a mile wide. No restrictions have been put on flow and a few of the wells are pumped heavily. As a result the head of the water in the 200-foot sand has been so reduced that most of the wells in the center of the town do not flow at the surface, and many at lower elevations flow only at high tide. The sinking of one well on the water front has stopped the flow of a neighboring well on ground a few feet higher. Many of the wells were poorly cased and there is probably much leakage under ground. That this loss of head is purely local is shown by the high heads of wells tapping essentially the same horizon at points a mile or two from town."

Yield of Wells. — No general statement can be made regarding the yield of wells in stratified rocks, since it varies so for different wells tapping the same formation. It has been noted, however, that with beds of the same porosity it varies with the pressure at the point of discharge.

Thus it has been noticed in Iowa, that some of the deep wells of the valley towns have a relatively larger yield than those of the upland towns, due to the difference in elevation with relation to the intake. An experiment bearing on this point is the case of a well at Hitchcock, Texas.¹ Here the discharge was 8022 gallons when the point of discharge was 25.35 feet above the curb, and 95,000 gallons when it was .76 feet above.

Pumps and air lifts cause a similar increase in flow.

Wells in glacial till and in many igneous and metamorphic rocks commonly yield but a few gallons per minute. A large proportion of medium-diameter wells drilled to a considerable depth into sandstone, limestone, or basalt supply 25 to 100 gallons per minute, but many from such rocks yield several hundred gallons, and a few even yield over 1000 gallons.

If in clean gravel at least a few feet thick, a yield of 100 to several hundred gallons per minute can often be looked for, and a few supply

¹ U. S. Geol. Surv., Wat. Sup. Pap. 293, p. 126, 1912.

more than 1000 gallons. A mixture of fine material with the gravel will decrease the yield materially.

It is probable that a majority of the wells in the United States yield less than 10 gallons per minute, and the discharge of shallow wells commonly fluctuates in sympathy with seasonal fluctuations of the water table (Ref. 11).

Source of water in aquifers. — Most of the water obtained from artesian wells in stratified rocks is of surface origin. In some, however, there is found saline water which may have become imprisoned between the grains of sediment when these were deposited on the sea bottom (connate water).

Fuller says:¹ "If marine beds are lifted above sea level while still in an unconsolidated condition, much of this water will drain out, except when the beds are so warped in the process as to form troughs or when drainage is prevented by the presence of overlying impervious beds."

Some wells near Wilmington, N. C., afford cases of included water in beds not yet uplifted, for flowing wells yielding salt water have been obtained at a number of points. The pressure here comes from meteoric waters which enter at the outcrop near the inner edge of the Coastal Plain sediments, and as the salt water is pumped out, fresh water takes its place.²

Depth of aquifer. — A water-bearing stratum dips away from the outcrop with a uniform or varying dip. In some districts wells penetrate the aquifer at not more than 100 or 200 feet depth, while in other districts drillers sometimes go to a depth of 2000 or 3000 feet to obtain a supply of water.

In Australia a number of exceptionally deep wells have been drilled, which obtain water from depths of 3000 to 4700 feet. The deepest yields 600,000 gallons daily (Ref. 9).

Irregularities in the Behavior of Wells

Both dug and deep-drilled wells often show variations in head, flow and clearness, which puzzle many persons, although they are easy of explanation.

Fluctuations of head. — The fluctuation in head of wells may be due to rainfall, melting of snow, freezing and thawing, and atmospheric pressure. All of these causes affect the supply of water penetrating the soil, and apply to dug wells. The atmospheric pressure will also affect deep wells, and some that require pumping during fair weather flow freely during storms.

¹ U. S. Geol. Survey, Bull. 319, p. 18.

² Water Sup. and Irr. Pap., 160, p. 96.

Roiliness of well water. — Well water is usually clear, but sometimes becomes milky on the approach of a storm, which is due to small amounts of silt or clay or iron oxide if the color suspended in the water is yellow or red.

Blowing wells. — This phenomenon, which is noticed in both drilled and dug wells, is due to a current of air which issues from them. It is sometimes strong and very noticeable.

Breathing wells. — Blowing usually alternates with sucking, and wells which show both expulsion and drawing in of air are called breathing wells, but the indraft is often overlooked because it is not as conspicuous as the outdraft. In moist climates

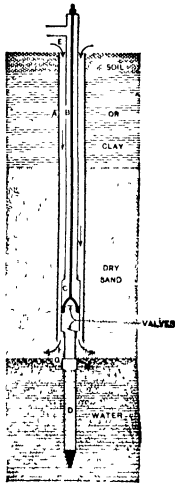

FIG. 161. — Conditions governing freezing in a cased well with escape of air at bottom. (After Sanford. From Fuller, Domestic Water Supplies.)

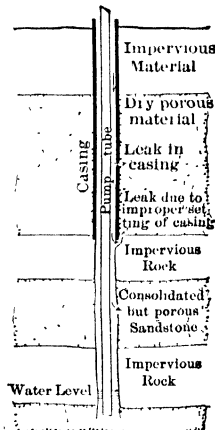

FIG. 162. — Conditions governing freezing in wells with leaky casings and porous walls. (Fuller.)

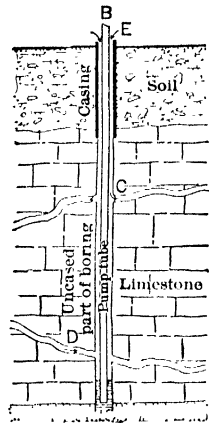

FIG. 163. — Conditions governing freezing in limestone wells. (From Fuller, Domestic Water Supplies.)

blowing is commonly strongest before storms, and sucking in clearing weather, and thus they show a relation to barometric pressure.

Freezing of wells. — In the northern states especially, much trouble may be caused by the freezing of both dug and drilled wells, more particularly the deeper drilled ones. Indeed some wells in the North are kept from freezing only with great difficulty.¹

In open wells cold air can enter and freezing may occur, but in covered dug wells there is usually little trouble unless the water level is near the surface, and the same is true of the simpler type of driven wells with single continuous casing or double tubes, which are carried below the groundwater level. (Fuller.)

¹ Fuller, Water Sup. Pap. 258, 1911, p. 23.

Most of the wells subject to freezing are the drilled or double-tube wells, in which the inner pump tube is carried below the outer casing, and stops in some porous stratum, and the wells drilled in limestone or other rocks containing open solution passages.

In Fig. 161 the cold air entering at *E* can flow downward and enter the dry sand at *F*. If any water is left in the valves at *C* it is frozen, and, moreover, the entrance of cold air may eventually freeze the water in the sand around *G* and *D*.

A second case is shown in Fig. 162. Here the cold air can enter not only at *E* but from some other point, and will follow along the solution channel *D*.

According to Fuller the wells of Maine, for example, many of which are in granites, slates, shales, and other hard rocks free from openings, give no trouble by freezing. On the other hand, in Minnesota, North Dakota, and Nebraska many wells penetrate porous deposits or cavernous limestones and freeze every winter. Even in Pennsylvania freezing sometimes occurs in oil wells at a depth of several thousand feet.

Cause of preceding phenomena. — It seems quite evident that fluctuations of head and flow, breathing, freezing, etc., are all referable to a single cause, i.e., barometric pressure.

Thus freezing, indraft, depressed water level, decreased discharge, and clear water appear to accompany a high barometer; in other words, increased atmospheric pressure.

Thawing, blowing, increased head, and milkiness all accompany a low barometer or decreased atmospheric pressure.

To illustrate: If the barometric pressure is low, the water may flow from the well more rapidly, and the increased velocity of flow may carry clay or silt out of the pores of the rock causing roiliness of the water. During high barometer in cold weather the cold air is forced down the well hole and produces freezing. The remedy for this is to seal up the top of the well and prevent the ingress of air as much as possible. In limestone where solution channels afford a by-pass to the cold air, the well may need packing from top to bottom.

Groundwater Provinces

Groundwater supplies are found in many parts of the United States but owing to the diversified character of the water-bearing materials and variations in geologic structure, the manner of occurrence of the water is not always the same.

In an earlier edition the authors subdivided the United States into ten groundwater provinces, but the great increase in our knowledge of groundwater distribution makes it desirable to recognize twenty-one provinces as recently suggested by Meinzer (Ref. 9). This classification is based on the presence of one important group of aquifers in a subdivision or province, or where more than one of the principal group of aquifers occur, on the coextension of two of the most important groups as a means of delineating the province. (W. S. 427, Bibliography of publications of U. S. G. S., relating to groundwater).



PLATE XLVI. — Map of United States showing groundwater provinces. (After Meinzer, U. S. Geol. Surv., Wat. Sup. Pap. 489, 1923.)

The provinces recognized are as follows (Pl. XLVI):

A. *Atlantic Coastal Plain province.* — Water is obtained in rather large quantities from Cretaceous, Tertiary, and Quaternary strata, which are chiefly sand and gravel interstratified with clayey beds. Very large supplies are obtained from alluvial gravels in the Mississippi Valley and adjacent areas. The province includes extensive areas of artesian flow, and the groundwater ranges from low to high in mineral content.

B. *Northeastern Drift province.* — The groundwater supplies are obtained chiefly from the glacial drift. The glacial till yields small supplies to many springs and shallow wells. The outwash gravels (Chap. X) yield large supplies notably on Long Island. Many drilled wells extending into bed rock give small supplies, chiefly from joints in crystalline rocks and Triassic sandstones. The groundwater is generally soft and otherwise low in mineral matter.

C. *Piedmont province.* — There are many shallow dug wells supplied from surface deposits or from the upper decomposed portions of the bed rock. Many drilled wells of moderate depth obtain water from joints in the crystalline rocks, and some wells in the Triassic sandstone yield rather large supplies. The waters are generally low in mineral matter.

D. *Blue Ridge-Appalachian Valley province.* — This is a region of rugged topography with numerous springs which generally yield good water from the Paleozoic strata, pre-Cambrian crystalline rocks, or post-Cambrian intrusives. The water supply comes chiefly from springs, spring-fed streams, or shallow wells.

E. *South Central Paleozoic province.* — The groundwater conditions are in general somewhat unsatisfactory, the chief sources of supply being Paleozoic sandstones and limestones. Throughout a considerable part of the province the Paleozoic rock supplies are meager and of poor quality, while the deep Paleozoic waters are highly mineralized. In many of the valleys large supplies are obtained from glacial outwash and other alluvial sands and gravels.

F. *North Central Drift-Paleozoic province.* — Most of the groundwater supply is obtained from the glacial drift. Numerous drilled wells obtain abundant water from glacial outwash deposits or from gravel interbedded with till. The water from the glacial drift in this province is generally hard but otherwise good. In many small areas the drift gives rise to flowing wells, but many drilled wells end also in Paleozoic sandstone or limestone, and receive ample supplies of water. The deeper Paleozoic waters are generally highly mineralized and in many places worthless, but the shallower ones are commonly of satisfactory quality, except that they are hard. In many valleys the Paleozoic aquifers yield flowing wells.

G. *Wisconsin Paleozoic province.* — In this province most of the water supply is obtained from wells of moderate depth drilled into Cambrian or Ordovician sandstones or limestones. These as a rule yield ample supplies of hard but otherwise good water. In many of the valleys artesian flows are obtained from Paleozoic aquifers. The region is devoid of water-bearing drift except in the valleys, where there are water-bearing outwash gravels.

H. *Superior Drift-Crystalline province.* — Most parts of this province yield satisfactory water supplies from the glacial drift, but where the latter is thin, water supplies are generally scarce because the underlying rocks are metamorphic or igneous. Both the drift and rock waters range from soft waters of low mineralization in Wis-

consin, to highly mineralized ones — sometimes unfit for use — in the western and northwestern parts of the province.

I. *Dakota Drift-Cretaceous province.* — Important sources of supply are the glacial drift and the Dakota sandstone. The drift contains numerous wells which yield water that is hard but otherwise good, and available in nearly all parts of the province. The Dakota sandstone is an important aquifer, and yields many strong flowing wells, a number of which are over 1000 feet deep. While the Dakota water is

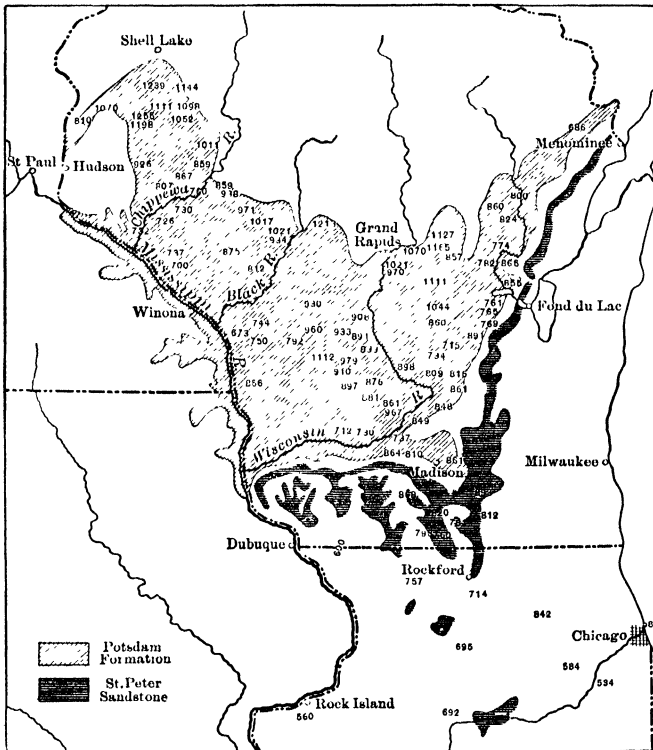

FIG. 164. — Wisconsin outcrop of Potsdam and St. Peter sandstones. Figures indicate height in feet above mean sea level. (After Slichter, U. S. Geol. Survey, Water Supply Bulletin, No. 67.)

highly mineralized it is nevertheless used for domestic purposes. The water from most parts of the formation is hard, but some wells yield soft water, which however is rich in sodium sulphate and sodium chloride.

J. *Black Hills Cretaceous province.* — The conditions in this province are rather unfavorable for shallow water. The Dakota sandstone is the chief aquifer, underlying most of the region except the Black Hills. The wells are usually deep. In the Black Hills proper some water is obtained from a variety of rocks.

K. *Great Plains-Pliocene province*. — The principal aquifers are Tertiary sands and gravels, and the Dakota sandstone. The sands and gravels are very satisfactory, yielding over large areas considerable quantities of good water from shallow wells. The Dakota sandstone underlies the entire province and gives various areas

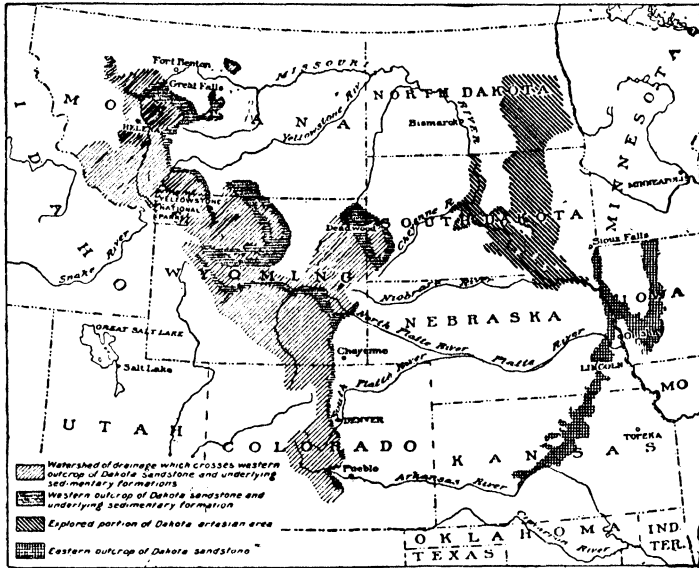

FIG. 165. — Darton's map of catchment area of the Dakota sandstone and the Dakota artesian basin. (After Slichter, U. S. Geol. Survey, Water Supply Paper, 67.)

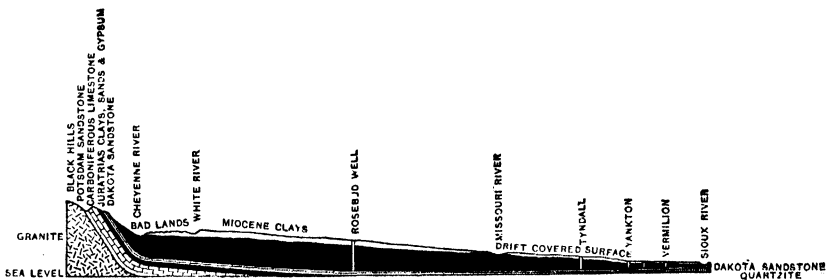

FIG. 166. — Section from Black Hills to eastern South Dakota, showing structure of artesian basin. (After Darton.)

of artesian flow. Under much of the province it lies too deep to be a practical source of water. Where the Tertiary formations are absent and the Dakota lies too deep, as in eastern Colorado, it is hard to get water. Many valleys contain Quaternary gravels, yielding much water.

L. *Great Plains Pliocene-Paleozoic province.* — The chief aquifers are Tertiary and Quaternary sands and gravels, which are as favorable sources of supply as those in the preceding province. Underneath the Tertiary throughout the province are Permian or Triassic red beds. These yield not much water, and that is highly mineralized. If therefore the Tertiary is absent water conditions are poor.

M. *Trans-Pecos Paleozoic province.* — The bed rock consists of Carboniferous and Triassic formations. In most of the province the supply of groundwater is meager and highly mineralized. In the Pecos Valley, however, the Carboniferous limestone and sandstone yield abundant supplies to flowing wells. The water is very hard but is all right for irrigation, live stock, and domestic uses. Locally there are overlying Quaternary water-bearing gravels.

N. *Northwestern Drift-Eocene-Cretaceous province.* — Groundwater is obtained from the glacial drift and the underlying Eocene and Upper Cretaceous. Where drift is absent, wells have to be sunk to the underlying formations and meet with variable success. In the western part of the area the sandstones of the Cretaceous generally yield water, but the shales are unproductive.

O. *Montana Eocene-Cretaceous province.* — Fairly good water in quantities adequate for domestic and live stock supplies, and generally also adequate for small municipal supplies, is obtained from lenses of sand and gravel in the Eocene and Late Cretaceous rocks. These beds rest on the Pierre shale which yields little or no water, so when the beds above the Pierre are absent the water supply is very poor.

P. *Southern Rocky Mountain province.* — This is underlain chiefly by crystalline rocks. The water supplies come chiefly from springs and spring-fed streams or melted snow, or from very shallow wells near the streams.

Q. *Montana-Arizona plateau province.* — This is mostly an arid to semi-arid plateau region, underlain by Paleozoic-Tertiary sediments, which have been warped enough to show a relation between rock structure and water occurrence. The water supplies are not plentiful nor very satisfactory. Locally there may be a Dakota sandstone aquifer and Quaternary water-bearing gravels.

R. *Northern Rocky Mountain province.* — A great variety of rocks of complicated and diverse structure underlie this province. The water, as in other mountain regions, comes chiefly from mountain springs and streams. Much water for wells is available in the sand and gravel filling the stream valleys, and of alluvial or glacial origin. Some water is obtained from wells drilled into bed rock.

S. *Columbia Plateau Lava province.* — The chief aquifers are the widespread Tertiary and Quaternary lava beds and interbedded or associated deposits of Tertiary sand and gravel. In general the lava yields abundant supplies of good water, and also gives rise to many large springs especially along Snake River in Idaho. Locally the lava and interbedded sands give flowing wells. Much of the lava however is so permeable and the relief of the region so great that in many places the water table is too far below the surface to be reached except by very deep wells. In some parts of the province glacial outwash deposits and ordinary stream deposits are also important as sources of water.

T. *Southwestern Bolson province.* — The chief source of groundwater supply in this arid province is the alluvial sand and gravel deposits of the valleys between the mountains. These water-bearing beds are important sources of supply for domestic uses, mining, live stock, irrigation and even municipal supply. In the elevated marginal parts of the valleys the water table may be very deep, while in the valley

bottoms which are underlain by clayey and alkaline beds the water may be limited and poor in quality, but under the intermediate levels large supplies of good water are generally found. This province includes the Valley of southern California and the Great Valley of California, in both of which water from the valley-fill is extensively used for irrigation. There is here some artesian flow but most of the water has to be pumped. In the mountain areas there are springs, small streams, and shallow wells.

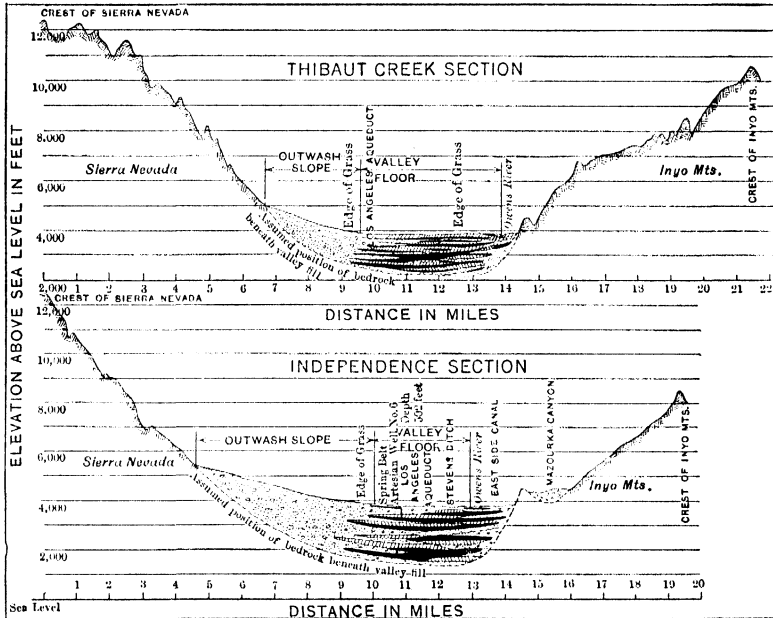

FIG. 167. — Sections across Owens Valley, Calif., showing unconsolidated beds in which the groundwater accumulates. (After Lee, Water Sup. Pap. 259, 1912.)

U. *Pacific Mountain province*. — This is a province of heterogeneous character. It consists chiefly of high mountains with some intermontane valleys. The precipitation is heavy. The water supply is obtained chiefly from numerous streams, but there are many shallow wells in the crystalline rocks of the Sierra Nevada and other parts of the province. The lowlands in the northern part of the province are underlain by glacial drift which yields water freely. The Tertiary beds of Oregon and Washington would probably also yield much water.

Composition of Groundwaters ¹

Introduction. — All groundwaters contain a greater or less quantity of suspended or dissolved matter, derived in part from rocks and soil.

¹ See further regarding composition of water in Chapter V.

The former may consist of clay, leaves, or bacteria; the latter of mineral substances, obtained in part from the rocks or soils through which the water percolates, its solvent power being increased by the presence of organic acids derived from the soils or other acids obtained from the air.

The water may thus obtain soda and potash from feldspars; calcium and magnesium from limestones, etc.; or iron oxide, alumina, and silica from different minerals of the soils or rocks.

But the quantity of mineral matter which the groundwater dissolves will depend also on the grain area exposed, the underground pressure and the rate at which the water is moving through the rocks.

As a result we find that groundwaters differ greatly in the kind and amount of mineral matter which they carry in solution, and upon this depends the usefulness of the water for one purpose or another.

It was formerly customary to state the water analyses in terms of hypothetical compounds that were thought to be present in solution. But at present, in conformity with the ionic theory, it is assumed and known that the mineral matter of dilute solutions exists mainly as free radicles, with the exception of silica.

The amount of mineral matter in solution is usually expressed in parts per million.¹

Relation of rock material to dissolved matter. --- Since many sands and gravels consist chiefly of silica, they may show only a few parts per million of dissolved mineral matter, although in desert sands and gravels the amount of alkaline and calcareous material may be large. Some sands and gravels may contain soluble mineral grains or other soluble impurities, which succumb to the attacks of the water filtering through them.

Fine-grained materials, like clay, expose considerable surface to solution, and the waters in them may be much more strongly mineralized than those in sand and gravel; indeed, some are so alkaline or calcareous as to be unfit for boiler use.

Waters in both sandstones and slates are somewhat more mineralized than those materials mentioned above, probably because they contain more cementing material than sands and clays, but the crystalline rocks contain still less, because the water circulates mainly in

¹ One liter of water weighs 1,000,000 milligrams, and therefore 1 milligram or .001 gram of solids per liter of water is equivalent to one part per million. To get grains per United States gallon, from parts per million, divide by 17.1, or from grams per liter, by 0.0171.

joint planes, and hence has comparatively little solution surface to work on.

Limestones give more soluble matter than any of the other rocks, as the carbonate of lime is rather easily soluble, and the waters from the softer ones often carry hydrogen sulphide.

Effect of mineral ingredients. — It is not within the province of this book to go into a detailed discussion of the chemistry of groundwaters, but a few of the more important points may be briefly touched upon.

Hardness. — This is due to sulphates and bicarbonates of calcium and magnesium. If the first type of compound predominates the hardness is permanent, but if the latter, it is temporary and can be broken up by boiling the water. It is said that if a water has 250 parts per million of hardness producing constituents, it is unfit for washing, but even harder water is still potable.

Boiler scale. — Many waters which are satisfactory for drinking purposes are unfit for boilers, since the mineral compounds are deposited as the water evaporates. Such deposits are poor heat conductors, and if allowed to collect may cause an explosion. The scale includes suspended silica, iron, and aluminum oxides or hydroxides and calcium or magnesium sulphates or carbonates.

The requirements of water for boiler use cannot be the same in all regions as waters vary. The strictest demands are found in New England where the railroads require water containing less than 4 grains of mineral matter per gallon, and grade this as excellent. From 4 to 8 grains per gallon is considered good; from 8 to 12 grains per gallon, fair; and above 12 grains per gallon, unfit for boilers. In some regions the waters are so mineralized that the last would be considered good or usable.

Corrosion. — Some waters corrode or pit boiler iron due to the free acids which they contain. This is especially true of waters draining from coal mines, since the alteration of pyrite in the coal yields sulphuric acid. Hydrogen sulphide, dissolved oxygen, and free carbon dioxide also exert a corrosive effect.

In some cases the acids may be freed in the boiler by decomposition of salts which were in solution.

Potable water. — The ordinary mineral ingredients of water, such as calcium, magnesium, silica, iron oxide, etc., are usually harmless in the quantities commonly present, but any constituent which is abundant enough to taste is bad.

It is said that water containing two parts per million of iron oxide is distasteful to some, and may even stain bowls and cloths.

Exposure to the air, or decrease of pressure, causes precipitation of the iron and consequent turbidity. Such waters often favor the growth of *Crenothrix* (a low form of plant life). This forms tufts and layers in pipes and well casings, sometimes clogging them. It is not of itself a cause of disease, but gives the water an unsightly appearance, and causes rusty stains.

Four or five parts of hydrogen sulphide give an unpleasant taste, and corrode well strainers and metal fittings. About 250 parts per million of chlorides will give water a salty taste.

The presence of abnormal amounts of chlorine in waters which have travelled but a short distance from the surface, or receive drainage from cesspools or barns, etc., is indicative of pollution, but the test is of less importance in deep artesian waters, as the chlorides may be soluble ingredients of the rocks traversed.

In regions where the chloride content runs as low as 5 or 10 parts in normal waters, unaffected by animal pollution, the chlorides are frequently taken as a measure of contamination. In southwestern Ohio, for example, the chloride content of the artesian water is naturally high, and wells near together may differ 200 or 300 per cent, owing to difference in the composition of the materials from which they draw their respective supplies.

Nitrites indicate the presence of decomposing organic matter, and nitrates, of such material already decomposed.

Suspended matter. — The suspended matter found in surface waters may be of animal, vegetable, or mineral character. That which is very fine-grained can be carried into the pores of the soil and rocks, but unless these openings are fairly large, the suspended matter even if fine is not likely to be carried for a great distance.

Suspended animal and vegetable matter is not so common in well waters, but finely-divided sand and clay are not rare.

For industrial purposes, where the water is used for washing or comes in contact with food materials, suspended matter is objectionable, for it is likely to stain or spot the product. If the suspended animal or vegetable matter is liable to decomposition or partial solution it is even more objectionable, even in small amounts (10 to 20 parts per million) than are equal quantities of mineral matter.

Color. — The color of water is due mainly to dissolved vegetable matter, and where it is to be used for bleaching, dyeing or paper making, any discoloration is undesirable. Color causes serious objection only when the vegetable matter in solution exceeds 20 or 30 parts per million.

Miscellaneous Effect of Subsurface Waters

Subsurface water is thought of primarily as a source of water supply, and while this is not unnatural, still it often does other work which may be a source of considerable trouble to the engineer.

Among these we may mention the relation of groundwater to landslides, tunneling operations, dam foundations, reservoir sites, railway embankments, and limestone caves and sinks. Some of these will be taken up and cases cited.

Clay slides. — Clay shows a great tendency to slide when it becomes water-soaked, the whole mass slaking down and flowing like so much tar. Large masses along river banks or in the face of artificial cuts are thus sometimes set loose and flow down to a lower level. The trouble is sometimes precipitated in excavations, by working the clay with a steep face instead of removing it in steps.

This subject is treated in more detail in Chapter VII.

Dam and reservoir foundations.¹ — In the construction of dams for reservoirs, it is essential that the foundations shall not only be solid but also water-tight in order to prevent the flow of water around the ends of the dam or underneath it.

In some cases bed rock lies so deep that the dam must be built on unconsolidated material like clay or sand. If this is not water-tight — and sand or gravel is apt to be permeable — the water either from the reservoir or ground may filter through at the sides of, or beneath, the dam, in gradually increasing quantities, so that eventually the structure is liable to give way, if proper precautions have not been taken. Dam failures due to this cause are not so uncommon.²

The breaking of a dam or reservoir wall is sometimes caused by the giving way of the foundation rock. This may happen if shale or clay layers are present in the rock on which the dam rests.

In the case of a dam in Pennsylvania it is said that the rock consisted mainly of sandstone beds from 1 to 3 feet thick which dipped down stream. Between these were some shaly layers 2 to 4 inches thick into which the water percolated, causing them to soften and slake. This permitted some movement of the foundation rock, which brought about the breaking of the dam.

¹ Another case is that of the reservoir at Nashville, Tenn.

The hill on which the reservoir stands is composed of thinly-bedded and much-jointed limestone between which are layers of shale from

¹ See further Ref. 65, and also under this topic in Chapter V.

² See Eng. Record, Apr. 14, 1912 (Oswego, N. Y.); Jan. 13, 1912 (Janesville, Wis.); Nov. 30, 1912 (Port Angeles, Wash.).

one-half to several inches in thickness. The rocks of the hill dip quite uniformly 3 to 4 degrees, the dip being about north 25 degrees west (Fig. 168). At the point where the first break occurred there is a small fold in the rock, causing a dip of 8 degrees in the opposite direction. The wall was built on this dipping rock. Lying between the rock beds on which the wall stands are several beds of clay, the thickest of which is 10 inches, and is 4 feet below the base of the wall. This and the other clay layers had become soft due to seepage, and

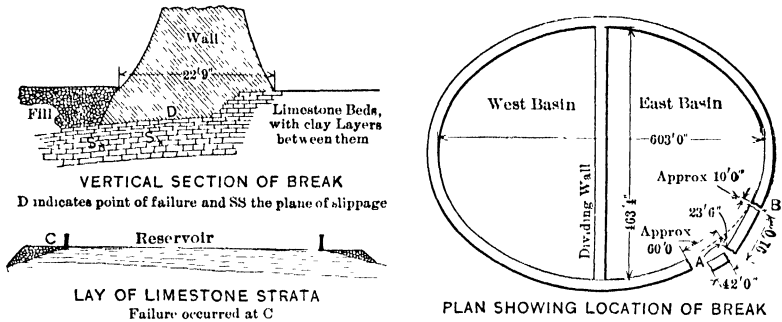

FIG. 168. — Plan and section of Nashville reservoir, showing cause of break. (After Purdue, Eng. Rec., LXVI, p. 539.)

under the weight of the wall and the pressure of the water the rock beds broke loose along the joints of the limestone and slipped off over the slickened surface of the clay layers.

Leakage around or under a dam might be due to several causes, such as porous beds in glacial drift, porous rock, solution cavities and joint fissures.

It is well known that deposits of glacial drift are rarely homogeneous, and that in masses of comparatively tight till there may be lenses or beds of permeable sand or gravel. If then the masonry of a dam rests in solid compact till, there may be little danger of leakage, but if sand deposits are present below or at the side of the dam, seepage of water is possible. This fact was given serious consideration by the engineers in locating reservoir sites for the Catskill water-supply system.¹

In many western states where volcanic rocks are abundant the porosity of the rocks is a feature that has to be given serious consideration. The porosity may be due to either amygdaloidal cavities in

¹ Berkey, N. Y. State Museum, Bull. 146.

lavas, or it may be due to the spaces between the grains and fragments of the rock.

A specially interesting case was encountered on the Clackamas River in Oregon where the rock was a very porous volcanic agglomerate, and it was found necessary to close it up in some way. Some idea of its porosity may be gained from the fact, that when grout was forced down a 50-foot pipe under 200 pounds pressure, it flowed across a 6-foot interval to another borehole, rushed up this and spurted 30 feet into the air.¹

No less serious sometimes is the construction of a dam in a limestone formation, for in some of these the rock is literally honeycombed by solution channels formed by underground waters.²

At Johnson City, Tenn., a reservoir was constructed on a hill of limestone, capped with residual clay. As usual the underlying limestone surface was very uneven, and under one corner of the reservoir there was a deep cavern in the bedrock filled with clay. "As the reservoir filled with water, the clay of the cavern settled, causing a rent in the floor on one side of the reservoir. The escaping water did not flow over the surface of the hill slope, but through a cavern and out into a railroad cut in the limestone on the hillside."³

Limestone sink holes and caverns. — Water percolating into limestones along joints and bedding planes often enlarges these by solution of the calcium carbonate. The point of entrance sometimes becomes expanded to an opening of considerable size (sink hole) into which surface drainage and occasionally streams disappear. So too the underground passages become enlarged by solution so that the limestone may contain a network of tunnels and caverns.

If these underground channelways become obstructed the water may stand in them, and is occasionally tapped by wells (p. 330). At other times they serve as drainage ways for surface refuse (p. 321). Occasionally their presence may be little thought of until the roof collapses.

A case of the damage caused by these solution channels was observed at Staunton, Va. Here a steep and large fissure which had been dissolved in the limestone extended beneath the town, the top of it being bridged over by a tightly-packed mass of residual clay. The fissure contained water, and its presence, but possibly not its extent, could

¹ See also case of Zuni River dam, Eng. News, LXIV, p. 203, 1910.

² See case of Hale's Bar on Tennessee River, Res. of Tenn., II, No. 3, Mar., 1912.

³ Res. of Tenn., III, No. 2, Apr., 1913.

have been known from the fact that the water from it was pumped up through a well and used for making ice.

Suddenly the clay bridge caved in for some distance, with the result that portions of several streets and other objects were engulfed (Plate XLVII).

The curious but absurd theory advanced by some was that as long as the fissure remained full of water, the latter held up the clay bridge, but that the removal of this support by pumping had allowed the cover to collapse.

If the water in the fissure had been in contact with the clay, it would have slaked it down instead of supporting it, and the real cause of the damage was the breaking of a sewer.

The water from the latter at the point of rupture in the sewer softened the clay so that it no longer held in place. The clay falling into the cavernous opening below served as a dam to the subterranean stream which was moreover augmented in volume by the water from the sewer. This, together with the damming, naturally caused the stream in the fissure to rise. In rising more soil fell in, and the stream, being more or less completely dammed, rose to the clay cover and caused still further caving.

Railway embankments. — Instability of bed is frequently noticed where the road is laid on clay formations, and is often caused by spring waters which soften the clay and cause it to slide.

Foundation work. — Groundwater is often encountered in excavations for foundations, especially in low-lying land where the water table rises close to the surface. At other times subterranean channels are cut into, which give considerable trouble, until confined. These latter are not by any means to be looked for only in limestone formations.

Tunneling operations. — In the construction of tunnels strong flows of groundwater are sometimes encountered. These are usually of meteoric origin, and are commonly cold, although sometimes warm or even hot. This water may travel downward from the surface along joint or stratification planes, fault zones or solution channels. In other cases it may seep in from a porous rock such as sandstone. Small inflows are not uncommon, but large ones are less often met with. Many interesting cases of this nature are on record.¹ (See further under Faulting and Folding, Chap. III.)

¹ See: Eng. News, Aug. 25, 1872. (Busk-Ivanhoe tunnel, Colo.); Vernon Harcourt, Proc. Inst. Civ. Engrs., CXXI, p. 305. (Severn tunnel); Davies, Trans. Amer. Soc. Civ. Engrs., LXXX, p. 594, 1916. (Astoria tunnel); Davis, Irrigation



PLATE XLVII, FIG. 1. — Street in Staunton, Va., showing sewer pipe whose break started the caving, and holes formed in pavement.

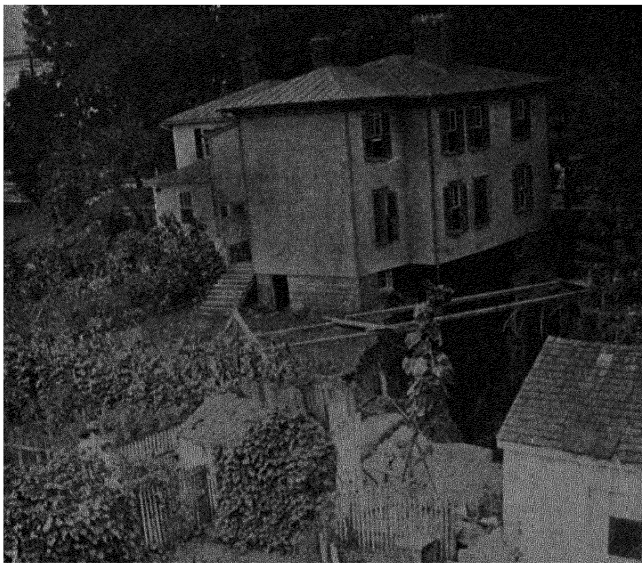

PLATE XLVII, FIG. 2. — View looking along line of limestone cavern, Staunton, Va., showing some of the damage caused by the clay roof of cavern collapsing.

References on Subsurface Waters

The following abbreviations are used in the references given below: W.S.P. = U. S. Geological Survey, Water Supply Papers; P.P. = U. S. Geological Survey Professional Papers; Bull. = U. S. Geological Survey Bulletins; Fol. = U. S. Geological Survey, Geologic Atlas Folios.

General. — 1. Bowman, W.S.P. 257. (Well drilling methods.) 2. Bryan, Jour. Geol., XXVII, p. 52, 1919. (Classification of springs.) 3. Fuller, Jour. New. Eng. Water Works Assoc., XXVII, No. 2. (Quantitative estimation of groundwater supplies.) 4. Fuller, Domestic Water Supplies for the Farm, New York, 1912. (Wiley and Sons.) 5. Fuller and others, Bull. 264, 1905. (Deep borings.) 6. Johnson, W.S.P. 112, 1905. (Laws governing subsurface waters.) 7. Keilhack, Lehrbuch der Grundwasser und Quellenkunde, Berlin, 1912. (Gebr. Bornträger.) 8. Lapworth, Assoc. Water Engineers, England, June, 1911. (Geology dam trenches.) 9. Meinzer, W.S.P. 489, 1923. (Groundwater in United States. Excellent.) 10. Meinzer, W.S.P. 494, 1923. (Outline groundwater hydrology and definitions.) 11. Military Geology. Chapter on Water Supply. New Haven, 1918. (Yale University Press.) 12. Woodward, Geology of Water Supply, London, 1912.

Areal. — 13. *Alabama.* Smith, Ala. Geol. Surv., 1907. W.S.P. 114. Fol. 175. 14. *Arizona.* W.S.P. 104, 136, 320, 375, 380, 425, 450. Fol. 111, 112. Bull. 352, 435. Ariz. Exper. Sta. Bull. 64. 15. *Arkansas.* W.S.P. 110, 114, 145, 399. Fol. 122, 140. P.P. 46. 16. *California.* W.S.P. 89, 112, 137, 138, 139, 142, 219, 222, 225, 278, 294, 345, 375, 398, 400, 429, 446, 450, 468, 495. Fol. 66, 138, 163, 193. Calif. Conservation Commission, Rep. 1912, p. 335. 17. *Colorado.* W.S.P. 9, 184, 240. Fol. 36, 58, 68, 71, 135, 153, 186, 198, 203. P.P. 32, 52. Bull. 265, 350, 531. 18. *Connecticut.* W.S.P. 110, 114, 232, 374, 397, 449, 466, 477. 19. *Delaware.* W.S.P. 106, 114. Fol. 137, 162, 211. Bull. 138. 20. *District of Columbia.* W.S.P. 114. Fol. 70, 152. Bull. 138. 21. *Florida.* Fla. Geol. Surv., Bull. 1, 1908. W.S.P. 114, 319. 22. *Georgia.* Ga. Geol. Surv., Bull. 15. W.S.P. 67, 114, 116, 341. Bull.

Works, 1917, p. 78. (Gunnison tunnel); Schardt, H., Rapport sur les venues d'eau rencontrées dans le tunnel du Simplon du Cote d'Iselle, 1902. Corbax, Lausanne; C. Schmidt, Die Geologie des Simplongebirges und des Simplon tunnels, Rektorats-Programm der Universität Basel für die Jahre 1906 u. 1907; Brunton, Tunneling. (Describes a number of large tunnels); Berkey, N. Y. State Mus., Bull. 146, p. 142, 1911. (Artesian flows in Catskill aqueduct.)

- 138, 164. 23. *Idaho*. W.S.P. 53, 54, 78. Fol. 45, 103, 104. Bull. 199.
24. *Illinois*. Ill. Geol. Surv. Bull. 5. W.S.P. 114, 164. Fol. 67, 81,
105, 145, 185, 188, 195, 200, 208, 213. Bull. 438, 506. 25. *Indiana*.
W.S.P. 21, 26, 113, 114, 245, 254. Fol. 67, 105. 26. *Iowa*. Iowa Geol.
Surv., XXI, 1912. W.S.P. 114, 145, 293. Fol. 145, 156, 200. 27.
Kansas. Kans. Univ. Geol. Surv., Bull. 1. W.S.P. 6, 140, 153, 258,
273, 345. Fol. 148, 159, 206, 212. P.P. 32. Bull. 238. 28. *Kentucky*.
W.S.P. 114, 164, 233. Fol. 184, 233. 29. *Louisiana*. W.S.P. 101, 114.
P.P. 46. 30. *Massachusetts*. W.S.P. 110, 114, 145. 31. *Maryland*.
Md. Geol. Surv. X, 1918. W.S.P. 110, 114. Fol. 13, 23, 136, 137, 152,
160, 179, 182, 204, 211. Bull. 138. 32. *Michigan*. W.S.P. 30, 31, 114,
182, 183. Fol. 155, 205, 206. 33. *Minnesota*. W.S.P. 114, 256. Fol.
117, 201, 210. 34. *Mississippi*. W.S.P. 114, 159. 35. *Missouri*.
W.S.P. 114, 145, 195. Fol. 148, 206. Bull. 438. 36. *Montana*. W.S.P.
221, 345, 400, 518. Fol. 55, 128. 37. *Nebraska*. W.S.P. 12, 70, 215,
425. Fol. 85, 87, 88, 108, 156, 184, 215, 216. P.P. 17, 32. 38. *Nevada*.
W.S.P. 365, 375, 423, 425, 450, 467. Bull. 530. 39. *New Hampshire*.
W.S.P. 114, 145. 40. *New Jersey*. W.S.P. 106, 114. Fol. 137, 157,
161, 162, 167, 191, 211. Bull. 138. 41. *New Mexico*. W.S.P. 123,
158, 188, 260, 275, 343, 345, 380, 422, 425. Fol. 157, 199, 207, 214.
Bull. 435, 618. 42. *New York*. W.S.P. 110, 114. Fol. 145, 157, 169,
172, 190. P.P. 44. 43. *North Carolina*. W.S.P. 114. Fol. 80, 124,
147, 151. Bull. 138. N. C. Geol. and Econ. Surv. Vol. III. 44.
North Dakota. W.S.P. 575. Fol. 117, 168, 181. *Ohio*. W.S.P. 91,
114, 259. Fol. 157, 184, 197. 45. *Oklahoma*. W.S.P. 148, 345. Fol.
122, 132, 154. Bull. 641, 691. 46. *Oregon*. W.S.P. 53, 54, 78, 220,
231. Fol. 78, 103. Bull. 252. 47. *Pennsylvania*. W.S.P. 106, 110,
114. Fol. 102, 121, 123, 144, 146, 157, 160, 162, 167, 170, 172, 174, 179,
189, 211. Bull. 138, 300, 531. 48. *Rhode Island*. W.S.P. 114. 49.
South Carolina. W.S.P. 114. Fol. 147. Bull. 138. 50. *South Da-*
kota. W.S.P. 34, 90, 227, 428, 627. Fol. 85, 96, 97, 100, 107, 108, 113,
114, 127, 128, 156, 164, 165, 209. P.P. 32, 65. Bull. 575, 627. 51.
Tennessee. W.S.P. 114, 164. Fol. 124, 151. Tenn. Geol. Surv. Bull.
26, 1921. 52. *Texas*. Tex. Univ. Min. Surv. Bull. 9. W.S.P. 154,
183, 190, 191, 194, 276, 317, 335, 343, 375. Fol. 42, 64, 76, 166, 194.
53. *Utah*. W.S.P. 157, 199, 217, 277, 333, 380. P.P. 56. Bull. 541,
628. 54. *Vermont*. W.S.P. 110. 55. *Virginia*. Va. Geol. Surv.,
Bull. 5. W.S.P. 114, 258. Fol. 13, 22, 80, 136. Bull. 138. 56.
Washington. W.S.P. 53, 54, 55, 111, 118, 316, 425. Fol. 86, 106.
Bull. 108. 57. *West Virginia*. W.S.P. 110, 114, 179. Fol. 160, 179,

184. 58. *Wisconsin*. Wis. Geol. and Nat. Hist. Surv., Bull. 35. Bull. Univ. Wis. 106. W.S.P. 114, 145. Fol. 140, 145. Bull. 32. 59. *Wyoming*. W.S.P. 70, 425. Fol. 107, 108, 127, 128, 141, 142, 150, 173. P.P. 32, 51, 53, 56, 65. Bull. 285, 364, 425, 471, 543, 621, 641, 656.

CHAPTER VII

LANDSLIDES AND LAND SUBSIDENCE

Definition. — Under this term are included all downward and often sudden movements of surface clay, sand, gravel, and even solid rock.

The movement is in response to gravity, and is often aided by the fact that the material has become water-soaked and is very mobile.

Landslides are frequently referred to in a casual manner in geological text books, and their destructive effects are sometimes commented on, but it is doubtful if their full importance as a factor in applied geology is always realized; moreover, in the minds of many their occurrence is commonly associated with mountain districts.

The slow creep of soil down the hillside, the sudden rush of rock or unconsolidated material down the mountain slope, or the slide of soft mud below the water surface, all interfere from time to time more or less seriously with engineering operations, and consequently it is of importance for the engineer to know something about them.

Although the presence of water in the rocks and soils is often a powerful factor in initiating a landslide, still in some cases earthquake shocks have played an important rôle in dislodging the masses of moving material.

Classification of Landslides

Professor Heim of Switzerland who has given the subject of landslides most careful study has suggested the following classification which does not translate very satisfactorily into English.

Landslides (Bergstürze).	Movements involving detritus (Schuttbewegungen).	I. Soil slips (Schuttrutschungen).
		II. Earth slides of greater magnitude than I (Schuttstürze).
	Movements involving solid rock (Felsbewegungen).	III. Rock slips (Felschlipfe).
		IV. Rock falls (Felsstürze).
	V. Compound slides, with respect to character and movements of materials. (Gemischte und zusammengesetzte.)	
	VI. Unclassified and special cases.	

The several types will be taken up, and examples of each given as far as possible, together with a statement of the trouble they have caused.

Type I. — This type includes those slow, downward movements of soil or other unconsolidated material, and is commonly referred to as *creep*. It may originate on any slope except one of very low angle, and involves not only soft clay and sand, but also the angular rock fragments of talus slopes.

Where steeply-dipping rocks crop out on a hillside, the upper portions of the layers are sometimes bent over by the general down-slope movement of surface material, so as to give the impression that the dip is in the opposite direction from what it really is.¹

These slow, creeping slides, while not as disastrous in causing loss of life, as rapid ones, nevertheless often give much trouble.

Thus a railway track laid across a talus slope has to be re-aligned from time to time because the slow movement of the soil or talus material displaces it. For example, near Field, B. C., on the main line of the Canadian Pacific Railway, the track is laid across the lower edge of a large talus heap on the eastern side of Mount Stephen. This slide is slowly creeping down necessitating more or less frequent straightening of the track. The same thing often happens where railroads cross clay slopes, but here the case is sometimes aggravated by the clay swelling when it absorbs water.

Tunnels or mine shafts penetrating material of this sort, are also likely to be thrown out of line, or even squeezed together.

Drinker (Ref. 3) in his classic work on Tunneling states that there have been many cases of landslides by which parts of railroads located along mountain-slopes have been displaced, and that sometimes tunnels have been affected, one of the most noted examples being that of the Mühlthal tunnel on the Brenner Railroad in Europe (Fig. 169). The rock was an argillaceous schist, requiring blasting, and where the slide occurred the tunnel was very near the surface. "During the building it was observed that the hillside had been shaken, and finally it became necessary to break through the side walls, and sink shafts down some 20 feet to solid rock all along the damaged section, and a heavy retaining wall was then built up."

The foundations of buildings built on a creeping surface may be similarly affected.

Type II. — The slides of this type differ from Type I in being of greater magnitude, but mainly in the more sudden and violent char-

¹ See U. S. Geol. Survey, Prof. Paper 56, Plate VII, p. 60, 1907, for a good case.

acter of the slide which may be either rock or soil. The angle of slope is not necessarily steep, or the point of starting necessarily high above the surrounding country.

Common examples of this type are the frequent dirt and rock slides that move down the slopes in some mountain regions, cleaning out all the vegetation in their path and leaving a bare scar on the mountain side.

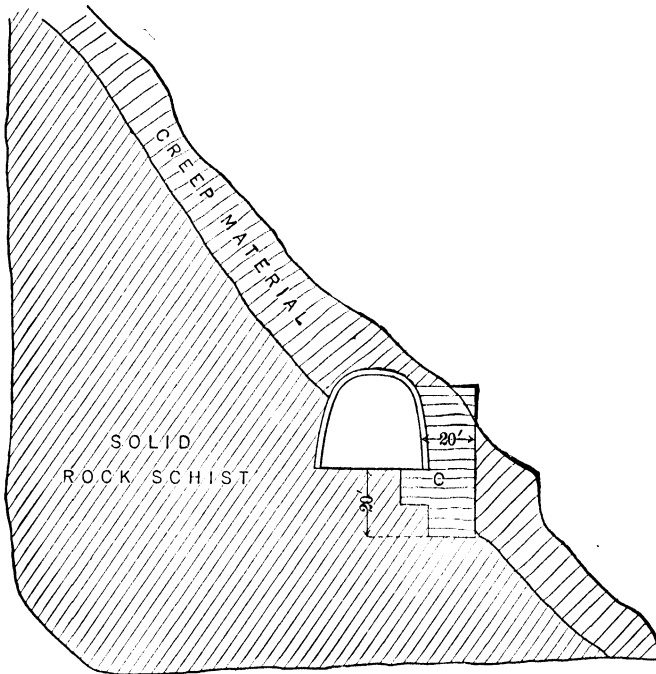

FIG. 169. — Section showing position of Mühlthal tunnel and creep material on Brenner Railroad. (After Drinker, Tunneling.)

Such a mass may cling to the mountain slope for a long time until loosened by frost, or softened and soaked with rain water, when it comes down suddenly and without warning.

Clay slides, sometimes of considerable magnitude, are not uncommon, and occasionally occur below surfaces of slight relief, as, for example, some low-lying river terraces. Since such movements are quite common, a few words may be said regarding the variation which they show as to nature and cause. Newland (Ref. 18) suggests the following types:

1. Flows, often exhibited by clays or silts that have become so water soaked as to be rendered mobile (Plate XLVIII, Fig. 1). The

mass may slide over lower-lying wet layers, or on a smooth rock surface.

2. Slumping, which refers to the local, more or less sudden downward movement of a mass of slightly moist clay. The movement is intermittent, and the slide may form a mound-shaped mass at the bottom of the slope. The detachment and downward movement of one mass may be followed after an interval by others. Where the slumping takes place in clay the moving mass may be more or less deformed, but in more solid rock, block-like masses break off which, for the most part, retain their shape, so that the slide slope is composed of a succession of tilted blocks.

3. Clay slides due to the squeezing out of a wet substratum, which becomes so softened by soaking that it gives way under the pressure of the overlying mass, causing the latter to slide.

4. Subsidence from unbalanced pressure on a confined liquid substratum, leading to reciprocal upward movement at a distance. Cases of this according to Newland (18) have occurred in the Hudson River Valley.

Cases of slides. — The following cases will serve to illustrate some of the points mentioned under Type II.

A good case of a flow slide is that which occurred on the Lièvre River, north of Buckingham, Quebec (Fig. 170). Here there was a clay terrace resting on gneiss and granite. The clay had become so thoroughly water-soaked after several days' rain, that an area of about 100 acres slid into the river. But so great was the pressure that the clay was pushed entirely across the stream, which had a width at this point of six chains, and masses of it were deposited on the east bank to a height of from 20 to 30 feet.¹ In addition a tongue of the clay moved up stream and displaced a crib-work dam, pushing it at least 100 feet.

This is not an uncommon phenomenon in valleys where clay terraces rise above the river level, and many of them have occurred, for example, in the Hudson River Valley of New York State.

While slides of this sort are likely to occur when the clay becomes water-soaked, still their descent is sometimes hastened by any cause which steepens the face of the bank. Thus the undercutting of a clay deposit by a stream, or any artificial excavation which gives a steep face, leaves the bank without proper support and invites a slide.

Some years ago, the brick pits at Haverstraw, N. Y., were worked towards the city, leaving a steep and high face, which resulted in a

¹ Can. Geol. Survey, Ann. Rept., Vol. XV, Part AA, p. 136, 1904.

portion of one of the streets and a number of houses sliding into the excavation.

Engineers in making railway cuts through clayey material sometimes overlook the tendency of the clay to slide, which is sure to occur if the angle of the embankment is too steep.

Shales which slake down easily are apt to slide almost as readily as clay, and where towns are located on terraces underlain by such materials, some means should be taken to retard the slipping of the

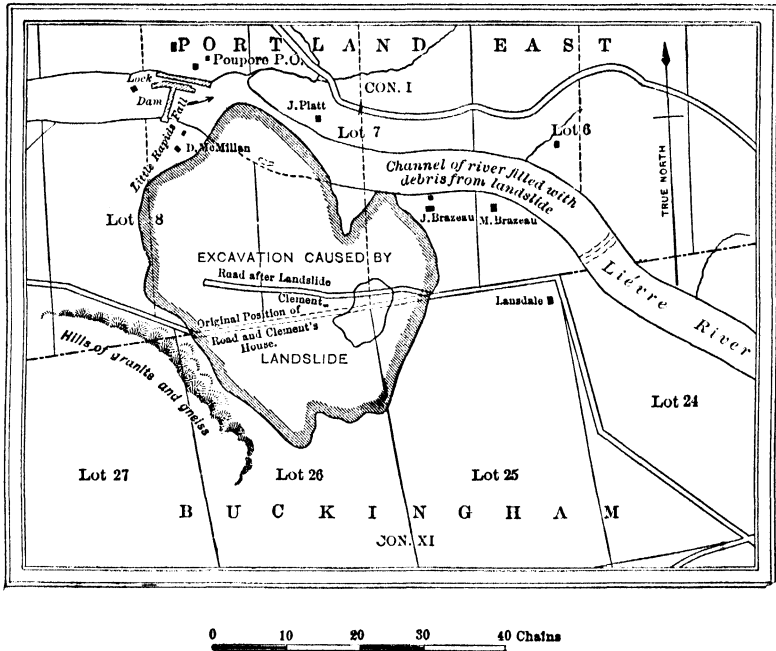

FIG. 170. — Map of slide on Lièvre River, Que. (After Ells, Can. Geol. Survey, XV, Pt. AA, 1904.)

banks, for if it goes on unrestrictedly, the face of the cliff often slowly but surely recedes.

The Panama canal has furnished fine examples of clay slides (Ref. 4, 16).

The rocks underlying the table land cut through by the canal consist of soft sediments with interbedded tuffs and lava flows. Cutting through these are several massive intrusions of basaltic rock forming Gold Hill and Contractors Hill. On either side of them and extending

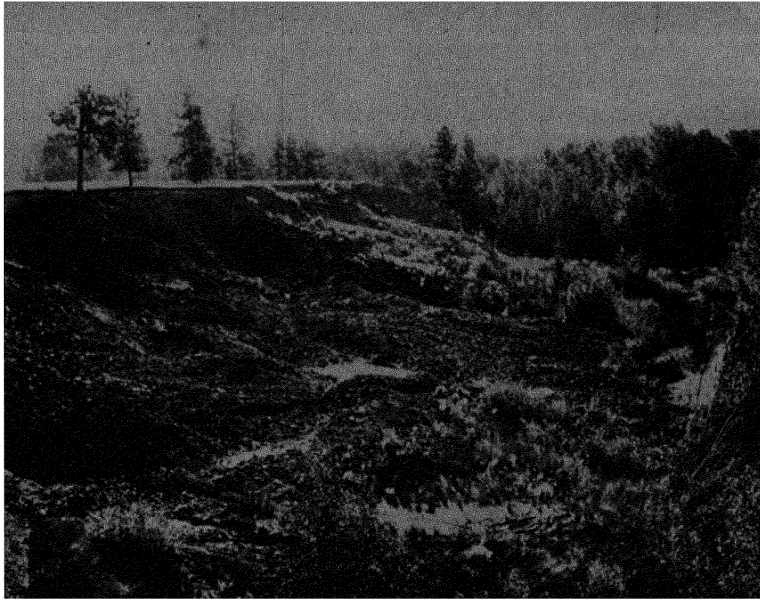
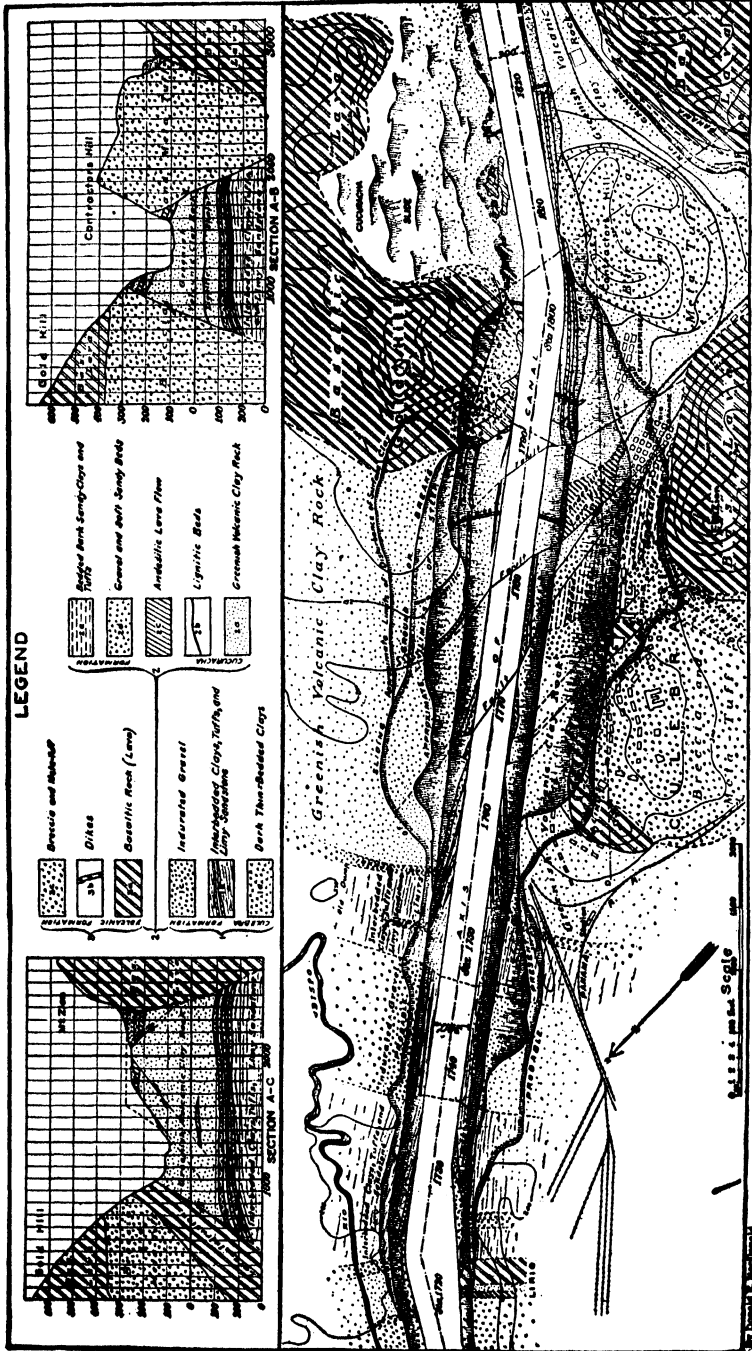

PLATE XLVIII, FIG. 1. — Slide of clay caused partly by undermining action of stream, and partly by clay becoming water-soaked. (H. Ries, photo.)



FIG. 2. — View of Turtle Mountain, Frank, Alberta, showing place from which rock fell, and a portion of slide in foreground. (H. Ries, photo.)



down to the base of the cut is a slightly indurated clay rock (Cucuracha formation). There are also local red clay beds and sandy lenses. The formation is much faulted and altered, and slippery due to chloritic material. When water soaked it slides easily. The canal excavation naturally left this water soaked clay unsupported so that extensive sliding developed and continued for some time (Plate XLIX).

Near Lake City, Colo., a mass of mud derived from cliffs of decomposed volcanic rock formed the Slungullion mud flow (Ref. 12), which rushed down a steep grade for a distance of 6 miles, making a dam across Slungullion river, so that a lake two miles long was formed.

The landslide barriers forming lakes, as above, sometimes give way, the rush of water causing devastation in the valley below.

In some cases a slide is precipitated by a soft, porous bed at the bottom of a cliff giving way. Thus in the Cascade Mountains in northern Washington (Ref. 21) the conditions favorable for landslides exist in places where the Columbia lava, in sheets 400 or 500 feet or more thick, rests on clays and sands, or on deposits of volcanic lapilli, and the series has been eroded so as to form steep escarpments. These conditions exist along the great northward-facing escarpment of Clealum Ridge, and on the western margins of the sloping tablelands known as Lookout and Table Mountains. (Fig. 171.) Numerous

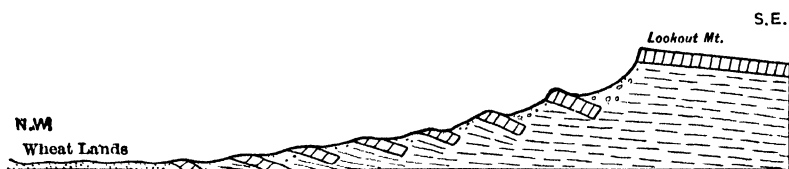

FIG. 171. — Ideal profile of landslides on the northern side of Lookout Mountain, Wash. (After Russell, U. S. Geol. Survey, 20th Ann. Rept., Pt. II.)

other localities along the western border of the Columbia lava, from Table Mountain northward to beyond the mouth of Okanogan River, mainly on the east side of the Columbia, furnish similarly favorable conditions for landslides, and hundreds have occurred.

The fact that the escarpments referred to are formed of the edges of nearly horizontal or but slightly inclined layers of hard basalt which are traversed by joints at right angles to the planes of bedding, and also the occurrence of layers of soft rocks beneath the hard cliff forming layers, furnish conditions unusually favorable for landslides.

Slides of unconsolidated material in fills. — All slides of type II are not confined to natural deposits. In many cases a fill put in to bridge a depression, or a large pile of dump material, may become water-soaked and slide, as in the case of Bigelow Boulevard in Pittsburg, Pa. (Ref. 22), or at Burdine, Ky. (Ref. 13). Road embankments on slopes sometimes behave similarly, especially if of clayey character, or if composed of rock fragments which become slippery when wet, as slate or schist.

Type III. — This, according to Heim, is restricted to cases where stratified rocks have a dip in the direction of the slope of the hill of which they form a part. Slipping is therefore initiated along the bedding planes of a rock.¹ Cleavage and joint planes might produce the same type of rock slip.

Slips of this type are likely to start from artificial causes. Thus, for example, if the stratification or cleavage planes dip towards the face of a slope, the removal of stone for quarrying,² or for road and railway cuttings, leaves the material unsupported (Fig. 171). If a slide does not occur at once, it is very likely to take place later when water and frost get into the mass.

Belonging to this type also are the interesting Rock Streams which Howe has described from the San Juan Mountains of Colorado (Ref. 12). He states that many of the high "glacial cirques of the San Juan Mountains are covered by enormous masses of rock débris resembling in its general appearance ordinary talus, but the form of these accumulations is quite unlike that of the long, even slopes of detritus at the base of cliffs. In many

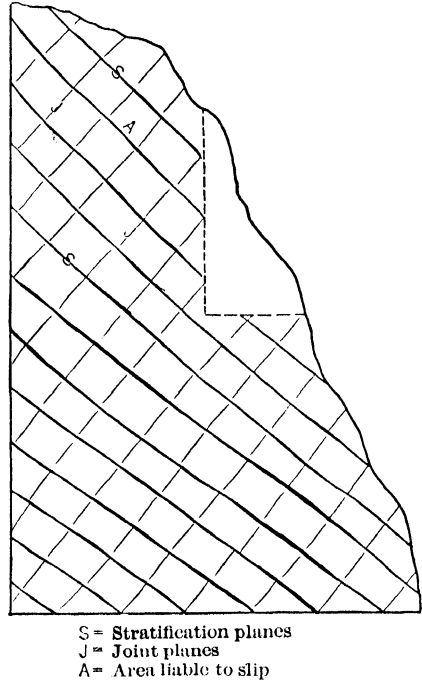

FIG. 172. — Section showing structural conditions likely to produce rock slides along joint or stratification planes.

¹ See, for example, slipping of bridge piers in a slippery clay over coal seam, Eng. News, XXXIX, p. 278, 1898.

² Geol. North Derbyshire, Mem. Brit. Geol. Surv., 1887, p. 83.

respects these masses closely resemble those of landslide origin in their general form and in their relation to the points from which the material has been derived." Indeed they remind one at times of small glaciers completely buried under a covering of loose rock.

One of the largest of these found in Pierson basin, in the San Juan Mountains, is from 50 to 100 feet thick, three-quarters of a mile long, one-third of a mile average width, and has a minimum estimated mass of nearly 13,000,000 cubic yards. The material is volcanic rock derived from the neighboring cliffs.

It is supposed that after the time of maximum glaciation, the walls of the cirques were left in an oversteepened condition by the undermining by the ice at the "bergschrund," and that after the disappearance of the ice the walls were left unsupported and toppled over.

Type IV. — Rock falls may take place regardless of the character or attitude of the rock mass. A fine example of this type was the rock fall that occurred at Frank, Alberta (Ref. 8), in 1903 (Plate XLVIII, Fig. 2). This was due to the breaking loose of a great mass of rock, about one-half mile square, and from 400 to 500 feet thick, from the top of Turtle Mountain. The latter towers about 3000 feet above the valley of Oldman River in which the coal-mining town of Frank is situated.

Turtle Mountain consists of westerly dipping limestones in its upper part (Plate L) and sandstones and shales in its lower part, the former being thrust over the latter by faulting. The rocks are also cut by numerous fracture and joint planes. In the lower beds there is moreover a coal bed which was being mined.

When the great mass of rock, estimated at 40,000,000 cubic yards, broke loose it was dashed to the base of the mountain, plowed its way across the valley and 400 feet up the other side. The slide material covered 1.03 square miles in the valley to a depth of from 5 to 150 feet.

The slide or rather rock fall was due to a combination of causes, as follows: (1) The form and structure of Turtle Mountain, which had a steep face, weak base, and was much jointed; (2) earthquake tremors in 1901 which probably loosened the rock somewhat; (3) a period of heavy precipitation and heavy frost; (4) the removal of coal from the seam along the foot of the mountain which removed some of the support. Curiously enough the width of the fall was about the same as that of the mine workings.

When the rock mass fell from the south peak it buried a number of ranches in the valley and a portion of the town of Frank.

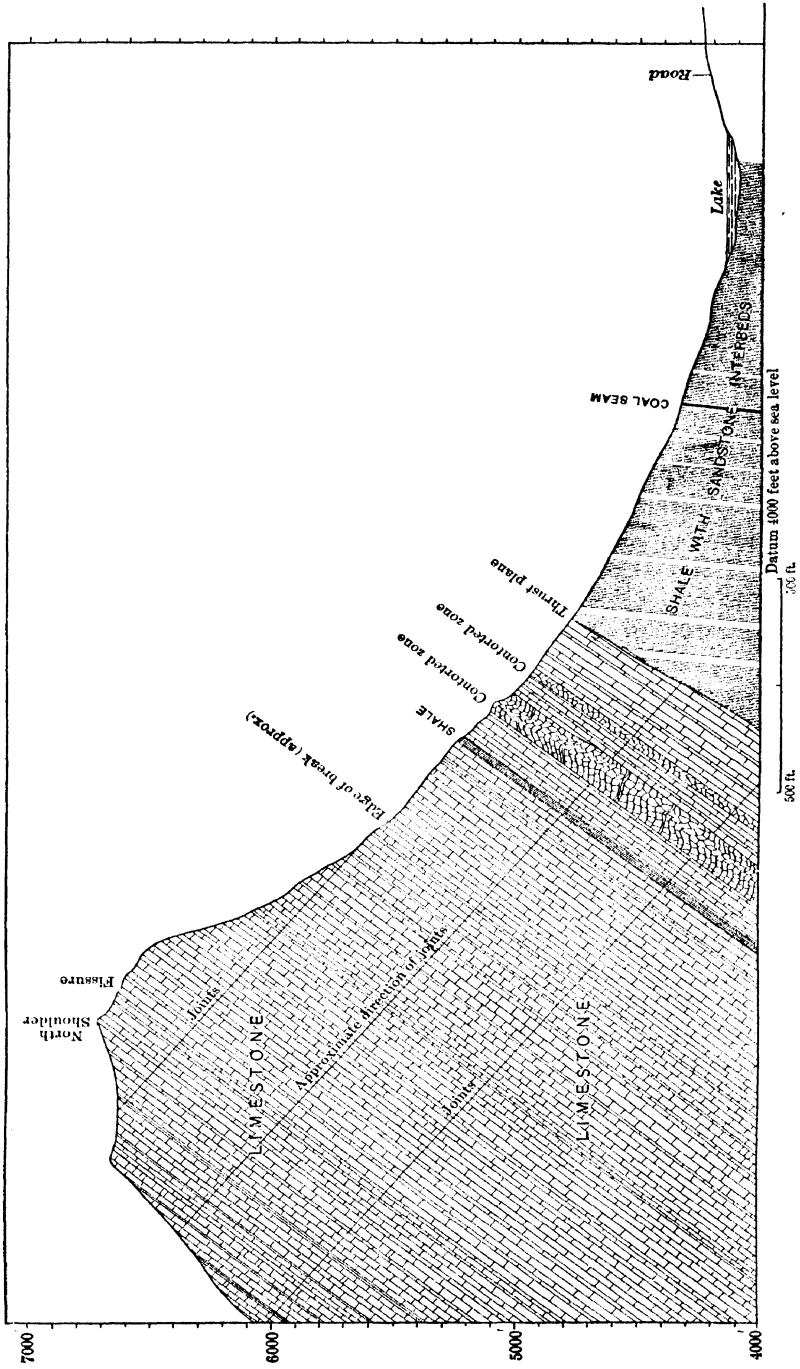

(367) PLATE L. — Section across Turtle Mountain, Frank, Alberta. (Can. Geol. Survey.)

After this slide occurred a widening crack which appeared on top of the northern peak gave rise to the fear that this was also likely to fall. Accordingly a commission was appointed to investigate the matter, and advised moving the town of Frank farther up the valley, and also discontinuing the mining of coal under the northern peak (Ref. 8). Up to 1924 the northern peak had not fallen.

Rock and clay falls are often caused along valleys by streams undermining their walls, or along the seacoast by waves undercutting the cliffs.

Type V. — This includes compound slides.

A case quoted from Heim is that of a large mass of limestone which broke off across the bedding and became detached from the cliff face. It fell down onto a wet clayey mass and started the latter sliding, the whole on reaching the edge of the ravine being precipitated into the stream and damming it.

Slides of this type are not necessarily uncommon, but few have been recorded. They have been described from Canyon Creek, southwest of Ouray, where the rock débris from Hayden Mountain has fallen on glacial gravels (Ref. 12).

Type VI. — The last type includes special cases as, for example, soft clays squeezed out between heavier massive beds and coastal slips. In the latter case soft beds at the base of a submerged mass, like a delta deposit, may squeeze out, allowing the overlying material to settle and slide.

Some slips along roadways or railway cuttings and cavings due to mining operations also belong in this group.

Engineering Considerations

Knowing that landslides frequently follow excavating operations, it becomes important for the engineer to know if possible what degree of slope is safe in different kinds of rocks.

Before explaining this, it is desirable to understand the meaning of several terms that are sometimes used, such as *angle of rest*, *angle of slide*, and *excavation deformation*.

Angle of rest. — This is the angle (with a horizontal plane) at which loose material will stand on a horizontal base without sliding. It is often between 30° and 35°.

Angle of slide. — This may be defined as the slope (measured in degrees deviation from horizontality) on which a slide will start. It is perhaps self-evident that it may vary considerably depending on several factors such as: (1) The weight of the overlying mass above

the slipping plane; (2) the character of the slipping surface, whether flat or undulating, and whether dry or wet. Clay, when wet, makes a very slippery surface; (3) character of material below slipping surface, and whether it will flow under pressure, like a wet clay. If this under clay squeezes out, a slide may be initiated on a slope of very low inclination.

As illustrative of the second point, mention may be made of an occurrence along the West Shore Railroad south of Newburgh, N. Y. Here considerable broken stone was dumped along the river bank to make a fill for the road. Although the slope of the mass did not exceed the angle of repose, there was much sliding. It was finally discovered that the river bottom on which the rock was dumped consisted of hard mud with a 20-degree slope, running down to 300 feet depth, and formed a splendid slipping surface (Ref. 20).

Angle of pull. — This term is used by some to indicate the angle between the vertical and an inclined plane bounding the area affected by the subsidence beyond the vertical.

Others would apply it to the effective resultant of the two groups of stresses set up in rocks adjoining an excavation, if it breaks the rocks down to that angle. In the rocks contiguous to the excavation these stresses may be of two kinds: (1) Crushing or direct gravity stresses, which are at a maximum near the toe of the steep excavation slope; and (2) tensional or flowage stresses, due indirectly to gravity, and exerting a horizontal pull towards the excavation, but giving a maximum deformation near the surface.

Excavation deformation.¹ — It has been suggested that the special name of *excavation deformation* should be applied to the zone around any excavation within which a structure might be disturbed by rock movements resulting from that excavation.

Factors affecting excavation deformations. — The strains set up in the rocks adjoining an excavation may be due to: (1) Natural processes, as stream erosion, solution, fault escarpments, etc.; and (2) artificial causes, as open cuts, underground, and submarine excavations. The extent to which any of these affect the rock is said to depend on the following factors:

1. Crushing strength of large masses of the material involved.
2. Tensile strength of large masses of the material involved. Variations in 1 and 2 are due to: (a) Strength of small component masses; (b) character of jointing; (c) character of bedding; and (d) fault conditions.
3. Physical and chemical character of the rock units.

¹ Freely abstracted from Ref. 17.

4. Amount and character of groundwater.
5. Earth tremors set up by earthquakes, blasts, trains, etc.
6. Other factors, as: (a) Heavy structures next to excavations; (b) water freezing in rock openings, and wedging off rock masses; (c) variations of barometric pressure; and (d) earth strains from kneading or tidal pull.

These factors may be briefly discussed:

1 and 2. A rock of high crushing strength, with few joint or other planes, will stand with a face that is practically vertical. The same rock, much cut by fracture planes, sloughs off masses from steep slopes, until a certain angle of permanent slope is attained. Any fissures inclining towards the excavation tend to cause slides, especially bedding planes with shale, lignite or other greasy rock partings, or fault planes with talcose partings. Such slides may occur even if the planes slope but gently, and have relatively slight back pressure.

With rock of low crushing strength, but relatively high tensile strength, slide movement shows sinking near excavations, slight advance of lower slope towards cut, and bulging upward of the excavation floor.

3. Very soft rocks, such as fine-grained and compact argillites and clays, may maintain a vertical face until excavation reaches a depth of 45 to 120 feet, or until unbalanced pressure is great enough to cause them to deform. Such deformation destroys stability of the clayey cementing materials, loosens them up so that surface water can enter, and causes mobility of the mass, with the result that the slope may break back from almost perpendicular to 1 on 10.

Deformations of the above type have occurred in the volcanic clay rocks of the Culebra cut of the Panama Canal.

Excavations which change the water table level may weaken surrounding rocks by dissolving and loosening their more soluble parts, especially in regions where the groundwater contains much carbon dioxide and organic acids.

4. Groundwater in rocks exerts a weakening influence, increasing their tendency to deformation because: (1) It adds to weight of the rock mass; (2) weakens the rock by solution and softening; and (3) increases the mobility of a mass of rock material.

If a porous rock rests on an impervious one, the water descending through the former will not only be deflected by the latter, but the wet clay particles carried down to this contact surface facilitate slipping. Even capillary water in a weak rock is a source of danger, for with deformation much of the capillary water may be crushed into the larger shear planes, thus giving them increased lubrication. In estimating sliding or deforming tendencies of a rock, careful determinations of its water content should be made on both fresh and air-dried samples.

The most troublesome slides of Culebra cut occurred in fine-grained basic volcanic clay shales of fairly massive character, which show from 6 to 17 per cent of water.

5. Earthquakes may be a cause of deforming movements in rock masses, but blasting is a common cause. Surface blasts cause less subsurface vibration than deep ones. Two large blasts in Culebra cut gave the following approximate vibration records. A blast of 2250 pounds of dynamite, exploded in 14-, 24-, and 28-foot holes, gave a maximum amplitude of vibration of 20 mm. at 1100 feet distance. Another of 5370 pounds of dynamite exploded in forty-eight 24-foot holes at about the same distance gave an amplitude of 28 mm. vibration on the recording instru-

ment. But as the magnification of the latter was 10, the earthwaves set up by the blasts were about 2 and 2.8 mm. respectively, or enough to damage seriously a steep slope of brittle rocks already heavily strained. Railway trains may also set up sufficient vibration to cause damage.

6. Heavy structures near excavations increase a tendency to slide, as subway and foundation engineers know. Variations in barometric pressure and the kneading of tidal pull are not to be overlooked. The maximum variations in atmospheric pressure near sea-level may be over 4,000,000 tons per square mile.

Slopes to minimize sloughing and deformation. Two classes of rock have to be considered: I, solid rocks which will not deform under pressure; and II, those which will show deformation under pressure.

I. Rocks of this class will slough but not flow, and the following limiting cases are given by MacDonald.

1. Solid rock with relatively high crushing and tensile strength; jointing, fissuring and bedding planes a minimum. Permissible slope 10 on 1. Includes rock like granite, trap, quartzite, solid sandstone, and shale.

2. Same rock as No. 1, but jointing and fissuring increased to average commonly encountered in excavations. Permissible slope 7 on 1.

3. Same rock as 1 and 2, but jointing and fissuring increased to maximum encountered in such rocks. Permissible slope 3 on 1.

4. Rock same as 1, jointing corresponding to 2 or 3, but excavation paralleling bedding or fault planes which dip towards it. Slope likely to be controlled by such planes as follows: (a) Individual beds, meter or more thick, with no clayey or slaty rock along them. Permissible slope 2 on 1; (b) rocks thinly bedded, with shaly, clayey, or slickensided conditions along bedding or fault planes. Safe slope, 2 on 3, but if bedding is not slippery, a 1 on 1 slope is safe.

II. In this case deformations or movements may extend to some depth below excavation, and some distance from it horizontally. The swelling ground in some tunnels, and in coal mines is an example of rock deformation of this type. These deformable rocks may stand at a steep angle until the excavation reaches a depth of perhaps 60 or 90 feet, then deform, and later slide until a flat angle is reached. For such rocks the slope which minimizes danger of deformation and gives maximum steepness will be a curved one.

The following table suggested by MacDonald gives the best slopes to adapt for excavation in the materials described.

TABLE OF SLOPES TO ADOPT AT DIFFERENT DEPTHS FOR DEFORMABLE ROCKS

Excavation depth.		A	B	C	D	E	F	G
Meters.	Feet.							
10	33	50 on 10	40 on 10	30 on 10	20.0 on 10	12 on 10	7 on 10	5 on 10
20	66	41 10	33 10	25 10	17.0 10	10.3 10	6.1 10	4.2 10
30	98	36 10	28 10	21 10	15.4 10	9.3 10	5.6 10	3.6 10
40	131	32 10	25 10	19 10	14.4 10	8.6 10	5.2 10	3.2 10
50	164	29 10	22 10	16 10	18.5 10	8.0 10	4.9 10	2.8 10
60	197	26 10	19 10	14 10	12.7 10	7.5 10	4.6 10	2.5 10
70	230	24 10	18 10	13 10	12.0 10	7.2 10	4.4 10	2.2 10
80	262	23 10	16 10	12 10	11.4 10	6.8 10	4.2 10	2.0 10
90	295	21 10	15 10	11 10	10.8 10	6.5 10	4.0 10	1.9 10
100	328	20 10	14 10	10 10	10.2 10	5.2 10	3.9 10	1.8 10
150	492	14.5 10	11 10	8.6 10	6.8 10	5.5 10	3.4 10	1.4 10
200	656	12.0 10	10 10	8.0 10	6.0 10	5.0 10	3.0 10	1.2 10

The kind of material indicated in each of these columns is as follows:

A. Certain fairly soft and weak sandstones, shales, some limestones, soft tuffs, agglomerates, and clay rocks — all deformable under great pressure, but yielding slowly. Includes rocks that cause swelling ground in coal mines, and other excavations, but stronger than the clay rocks and tuffs of Culebra cut.

B. Same as *A*, but with medium shearing and jointing.

C. Same as *A* and *B*, but with maximum of shearing, jointing, and fissuring. Beds may dip towards excavation.

D. Soft volcanic-clay rocks, bedded friable tuffs, and lignitic shales. This type caused the large slides at Culebra cut. They have much water and chloritic material, and a minimum of jointing, fissuring, and bedding.

E. Same as *D*, but some jointing and fissuring.

F. Same as *D* and *E*, but much jointed.

G. Very soft and crushed rocks, talcose clays, etc., rendered slippery by groundwater.

From these tables a theoretic slope should be first determined corresponding to the depth of excavation, character of rock, etc. Then plot cross-section of slope and bottom planes of the excavation as selected. A hyperbola tangent to these two, with its vertex in the projection of the bottom plane will represent about the proper slope and curvature of the excavation. In all excavations, allowance must be made for the fact that the soft decayed rock and soil material near the top will tend to erode back from the excavation until the surface approaches logarithmic curvature.

Landslides and reservoir sites. — Valleys are sometimes locally restricted by debris from landslides, and such locations are often selected because of their topographic character as desirable sites for dams. But while the topographic conditions may be satisfactory the landslide masses are not always able to withstand the pressure of a high head of water without serious leakage.

Such landslide deposits, because of the abundance of angular rock fragments which they contain, may often be more or less permeable in character. They may occur on one or both sides of a valley, sometimes meeting in the center.

Landslide masses may be distinguished from glacial deposits (which sometimes occur in the same region) by the following criteria. The materials composing them are angular, and the individual stones are not polished or striated. They do not contain as large a variety of rocks as the glacial deposits, the materials are derived from formations in the cliffs above them, and they are often of smaller extent. Moreover they show a close association with the cliffs from which they have been derived. They resemble glacial deposits in showing no assortment of material, and both may show depressions which are sometimes occupied by lakes.

The Farmer's Union Reservoir, thirty-three miles from Creede, Colorado, is held in by a dam about 100 feet high and 400 feet wide, constructed against a landslide. There has been seepage through the landslide mass, as well as through the much-fractured bed rock at one

place. At one point the water had evidently passed through one-eighth to one-quarter mile of slide material. If enough clay seeps in with the water the pores may become clogged; on the other hand there is danger that the waters may flow through in such volume and with such velocity as to wash the finer materials out of the landslide mass and render it even more permeable (Ref. 1).

Land Subsidence

The removal of large volumes of rock underground often causes a settling of the overlying rocks, which may extend to the surface (Ref. 28). Such subsidence may be due to the removal of soluble materials like salt or limestone, by solution, but in most cases it is due to mining, the chief trouble being caused by coal mining, which frequently extends over large areas.

This settling of the ground is not unnatural, and must follow complete extraction, unless expensive methods of back filling are employed, as in Germany and France. (Ref. 27.)

Extensive settling of the surface has followed the mining of porphyry copper deposits (example, Miami, Arizona), in parts of the Lake Superior iron region, and at the British iron mines in Cumberland, England.

The question of support and stability of the surface is, therefore, a serious one, especially in settled regions, as it affects municipalities, railroads, agriculture, etc. Indeed, many cases of subsidence are on record, especially in Europe.

The damage to municipalities caused by subsidence includes that done to streets, sidewalks, sewers, pipe lines, and foundations.

Where transportation is affected it involves damage to railroads, canals, and bridges, the sinking of the land being sometimes gradual, which requires filling as the settling proceeds. In some cases, for example, canals have been maintained at grade while the land settled 20 feet.

Agriculture may be affected by uneven settling of the surface which disarranges the surface drainage and causes ponds to form. It is said that Illinois drainage projects to remedy the trouble have cost \$15 to \$40 per acre (Ref. 27).

The geologic conditions affecting subsidence in solid rock include: (1) General character and dip of strata; (2) presence of faults, fissures, and other fractures; (3) direction of workings with regard to jointing of strata; (4) compressive strength of rocks forming the overlying beds; (5) bearing power of underlying beds; and (6) angles at which rocks break when stressed.

Large workings near the surface cause subsidence unless the proper precautions are taken, but the depth below the surface where workings may be excavated without causing trouble above, ranges in different observed cases from 50 to 2400 feet.

At Sutherland, England, where the beds are 50 per cent hard rock, coal beds 1400 to 1800 feet deep have been worked for 70 years without surface disturbance, while in Midland and South Yorkshire, where the rock is largely soft shales, workings at a depth of 2000 feet affect the surface (Ref. 28). Much damage by subsidence has been caused in the city of Scranton, Pa., as well as around Pittsburgh, Pa., and in the Illinois-Indiana coal fields.

A steeply inclined excavation is less liable to cause extended subsidence than a flatter one which has greater horizontal extent, but in both cases the number, size, and position of pillars supporting the roof of the mine workings are influencing factors.

Hard brittle rock when broken increases in volume more than plastic rock which tends to pack together, hence the former fills up the cavity faster, and subsidence upward is retarded. Soft rocks on the other hand sink more slowly and more regularly.

Where the rock is cut by extensive fractures, these may bound the subsiding area so that it settles like a block between them. If then we are dealing with a tilted bed, cut by joints at right angles to the stratification, the subsidence of the surface may not be exactly over the area of the mine in which the roof has settled. Furthermore if the bed rock is covered by unconsolidated material, the subsidence may spread out in this over a wider area than the settled portion of the bed rock occupies. This then results sometimes in the movement of the surface being horizontal as well as vertical.

References on Landslides

1. Atwood, U. S. Geol. Surv., Bull. 685, 1918. (Relation of landslides to reservoir sites.)
2. Bowles, U. S. Bur. Mines, Repts. of Investigations, Dec., 1921. (Md. limestone quarry.)
3. Bowles, *Ibid.*, Tech. Pap. 295, 1920.
4. Branner, *Sunset*, The Pacific Monthly, XXXVI, p. 13, 1916. (Panama Canal slides.)
5. Branson, Geol. Soc. Amer., Bull. XXVIII, p. 347, 1917. (Rock slide, Wyo.)
6. Brigham, Bull. Geog. Soc. Philadelphia, Oct., 1906. (Rock falls in lakes.)
7. Capps, Jour. Geol. XVIII, No. 4, 1910. (Rock slides, Alaska.)
8. Daly, Miller, and Rice, Can. Geol. Survey, Memoir 27, 1912.
9. Drinker,

H. S., Tunneling, 1878, p. 733. 10. Geikie, A., Textbook of Geology, 3rd ed., 1893, Land slips, ordinary origin of, 370; effects on rivers, 382; caused by earthquakes, 280. 11. Heim, A., Ueber Bergstürze, Zurich, 1882. 12. Howe, Landslides in San Juan Mountains, Colo., U. S. Geol. Surv., Prof. Pap. 67, 1909. 13. Jilison, Science, n. ser., LVIII, p. 185, 1923. (Gob slide, Ky.) 14. Lyell, Principles of Geology, 11th ed., 1889, Vol. I, pp. 346, 467, 540; Vol. II, pp. 130, 520. 15. McConnell and Brock, Can. Geol. Surv., Ann. Rept. 1903, Pt. 8. (Frank, Alberta.) 16. McDonald, Min. & Sci. Pr., Dec. 7, 1912. (Panama Canal.) 17. McDonald, Internat. Geol. Cong., Toronto, 1913. (Excavation deformations.) 18. Newland, N. Y. State Mus., Bull. 187, p. 179, 1916, and Geol. Soc. Amer., Bull. XXVII, p. 58, 1916. (Landslides in unconsolidated sediments.) 19. Patton, Geol. Soc. Amer., Bull. XXI, p. 663, 1910. (Rock streams, Veta Peak, Colo.) 20. Rice, Jour. W. Soc. Engrs., XVIII, No. 7, 1913. (Landslides, many references.) 21. Russell, U. S. Geol. Surv., 20th Ann. Rept., Pt. II, 1900, p. 193. (Cascades, northern Wash.) 22. Scharff, Eng. News Rec., LXXXV, p. 1076, 1920. (Bigelow Blvd., Pittsburg.) 23. Miscellaneous, Arrow Lake, B. C., Can. Geol. Surv., XV, p. 55, AA; Blanche River, Que., Can. Geol. Surv., XI, p. 121 A; Ibid. XVI, p. 16 F; I, p. 546; IV, p. 95 D; XI, p. 123 A; XI, p. 11 J; I, p. 606; XVI, p. 241 A. 24. Alden, Amer. Inst. Min. Met. Engrs., Trans. LXXVI: 347, 1928. (Gros Ventre slide.)

References on Subsidence

25. Calvert, Salt in Cheshire, London, 1915. (E. & F. N. Spon, Ltd.) (Subsidence from solution of salt beds.) 26. Goldreich, Theorie der Bodensenkungen in Kohlengebieten (Berlin, 1913). 27. McClelland, Mining Engineers Hand Book, New York, 1918, p. 737. (Wiley and Sons.) (Earth and rock pressures.) 28. Rice, Ibid., LXIX, p. 374, 1923. (Problems in ground movement and subsidence.) 29. Young, Ill. Geol. Surv., Bull. 17, 1916. (Surface subsidence from mining.) 30. Anon, The Lamp, Dec. 1929. (Sour Lake oil field.)

CHAPTER VIII

WAVE ACTION AND SHORE CURRENTS: THEIR RELATION TO COASTS AND HARBORS

Introductory. — Commercial intercourse between nations having coast lines, coastwise traffic on the ocean or inland bodies of water, *etc.*, demand the existence and maintenance of good harbors, as well as the preservation of shore lines. Along some coasts excellent natural harbors exist while along others some of the harbors, at least, require improvement by engineers. In either case the harbor is sometimes closed up or shallowed, either by sedimentation or gradual uplift of the land, or both, if natural forces are allowed to operate undisturbed.

There are cases, of course, where a harbor may become improved without the work of man. Thus, subsidence of the land, accompanied by little or no sedimentation, or in excess of sedimentation, will result in the deepening of harbors along coast lines of rugged topography.

The southeast Atlantic Coast harbors of the United States, for example, belong to the troublesome harbors on a sandy coast, because they are difficult to keep open and navigable. They represent a type which have been so long a cause of worry to engineers and governments, and which so often obstinately refuse to "stay put" after much money and time have been spent on their improvement. Maintained and destroyed by the same power, the sea, their formation and maintenance depend on so nice an adjustment and control of these forces, that it is not strange that disappointment has frequently followed so much painful effort (Black).

The trouble is caused primarily by wind and waves acting together in breaking down the shore line,¹ and transporting the products of attack from one part of the coast to another, but the shore topography and the sediment brought by the streams from the land are also factors that enter into the problem.

The engineer who is engaged in harbor improvements or maintenance should familiarize himself with the manner in which these agents work, so that he can if possible counteract or prepare for their operations, or even utilize their power to aid him.

¹ The phenomena of wave action and shore currents are not confined to the ocean, but have full play on lakes and inland seas as well, where the water can be agitated sufficiently by the wind.

Formation of Waves

Cause of waves. — The most common waves are generated by the wind.¹ When a strong wind blows across the surface of the ocean or lake, it starts each particle of water, near the surface at least, oscillating in an orbit, which is approximately circular and lies in a vertical plane. In the case of an off-shore wave there is probably little advance of the water, so that each particle returns nearly to its starting point.

In waves known as the swell, which is outside of the area directly affected by the wind,² the particles have closed orbits, so that there is no permanent advance of the water. But in the wind wave, the particle advances slightly more than it recedes, each particle describing an ellipse rather than a circle, which develops a current, that is slower than the wind.

If we think of the water as being made up of layers, then the top layer will move a little faster than the one next below and so on.

Waves developed in open water are known as *oscillatory* waves. The revolution of the water particles in their orbits can be observed by watching a floating object, which moves up and down as the waves pass it, but shows very little forward movement. In other words, it is the wave form that advances.

Zone of breakers. — As a wave approaches a shelving shore, its form changes, and the wave becomes both higher and shorter, the crest becomes steeper and sharper with the velocity of the advancing particle of water increased, and the front steeper than the back. This results finally in the breaking of the wave.

Waves of a given height will break in the same depth of water, and the line of *breakers* is that along which the incoming waves collapse.

The waves developed in shallow water, when the oscillatory waves break, are known as *waves of translation*. In these there is an actual forward movement of the water mass which follows no definite law.

These waves are quite efficient in sweeping material ashore during their forward dash. The return wash down the beach meets the next incoming translatory wave.

There is usually a zone between the water's edge and the breaker line, where material is being washed back and forth.

Waves break when the depth of water reckoned from undisturbed

¹ Destructive waves of great size are sometimes produced by earthquake movements and submarine volcanic eruptions.

² The appearance of the swell sometimes indicates the approach of a gale several hours in advance of its arrival.

sea level is equal to the height of the crest above the trough. Thus, for example, if a wave 8 or 9 feet high (or about 6 feet above still water level) is noticed breaking over a submarine bar, it indicates that the mean depth of the water is only about 8 or 9 feet, or 6 feet below the trough. This is not a fast rule, for it may be affected by such factors as the undertow (p. 380) or by a submarine terrace deflecting the water upward.

Depth of wave disturbance. — Wave disturbance does not extend to great depths because the size of the orbits decreases rapidly with depth. Thus at one wave length below the surface the water particles are moving in orbits whose diameters are 1/534.5 those on the surface. Or, in the case of a wave 20 feet high and 400 feet long, the orbit at the depth of 400 feet would be 4/10 inch. This fact is of interest to engineers, because of its relation to the disturbance of submarine structures. Engineering operations have shown that submarine structures are little disturbed at depths of five meters in the Mediterranean, and eight meters in the Atlantic Ocean.

Débris as coarse as gravel, which is transported by rolling on the bottom, is not infrequently carried out to depths of 50 and sometimes even to 150 feet. Fine sediment, like silt, is disturbed at still greater depths, for ripple marks which are usually present in the finest sediments, and indicate agitation of the water, are said to have been found at depths of 100 fathoms.

Wave dimensions. — Waves vary greatly in size, but those produced by storm winds on the open ocean may be of large dimensions. The *length* of a wave is the distance from crest to crest, while the *height* is the vertical distance between bottom of trough and top of crest. According to Johnson (Ref. 10a) the height of oscillatory waves depends on: (1) Strength of wind; (2) duration of wind; and (3) area of surface. Thus: Velocity of wind (miles per hour) ÷ 2.05 = height of waves in feet. The following figures of wave heights as measured at certain times are given.

<i>Wave height</i>	<i>Feet</i>
Lake Superior	20-25
Mediterranean	25-30
Southern Ocean	40-50

The ratio between length and height is given as follows:

<i>Wave length</i>	<i>Height</i>	:	<i>Length</i>
Under 100 feet	1	:	17
100-200	1	:	20
300-400	1	:	27

Storm waves in the Atlantic rarely exceed 600–700 feet. Johnson states that the greatest trustworthy measurement of wave length recorded is one from the north Atlantic measuring 2750 feet.

Velocity of waves. — The velocity of an oscillatory wave depends on its length and is proportional to the square root of the wave length. Large ones may advance at a rate of over 30 miles per hour. The velocity in miles per hour = $\sqrt{2\frac{1}{4}} \times$ wave length in feet. The velocity in feet per second = $2\frac{1}{4} \sqrt{\text{wave length in feet}}$. Shallow water waves advance less rapidly than deep water ones and they obey different laws, the calculation of their speed being less simple (Ref. 5).

Wave pressure. — The pressure exerted by waves may be *dynamic* or that of the moving water, or it may be *static* or due to the weight of the water. The latter is the lesser of the two.

The damage done to coast lines and to harbors is most impressive evidence of wave pressure. The following figures quoted from Johnson (Ref. 10a) will serve as illustrations.

On Lake Superior, Gaillard determined the static pressure of a wave 10.5 feet high and 150 feet long to be about 450 pounds per square foot, the dynamometer being 9 feet below the wave crest. The dynamic pressure of waves 10 feet high and 150 feet long varied from 460 to 965 pounds per square foot as determined by a dynamometer placed a foot higher than that used for determining the static pressure.

Storm waves on Lake Superior develop a blow of 1600 to 2500 pounds per square foot, while those on the Scotch coast in winter average 2086 pounds per square foot with a maximum of 6083 pounds.

More impressive, perhaps, are the following examples: At Cherbourg, France, a stone of 7000 lbs. was thrown over a 20-foot wall.

At Wick Harbor in 1872 the seaward end of a breakwater was protected by a monolithic block of cement rubble 45 ft. long, 26 ft. wide, 11 ft. thick and weighing over 800 tons. It rested on blocks of stone bound solidly to the monolith by $3\frac{1}{2}$ in. iron rods. The whole mass weighing 1350 tons was torn away by the waves and dropped inside the pier. It was later replaced by one of 2500 tons and this was also carried away.

Gaillard's observations. — Gaillard¹ in studying the force of waves on the Florida coast gives the following conclusions (summarized by Black). "Waves with the form of a common cycloid have an energy in foot-pounds for each foot in length measured along the crest, and for that portion above a horizontal plane tangent to the hollow, equal to $6.3 h^3$, in which h is the height from hollow to crest. The application of this formula is expressly limited, and is useful mainly in comparing the relative exposure of two places where shoal water extends for some distance seawards and where the fetch of the waves is practically unlimited.

Observations on waves varying in height from $2\frac{1}{2}$ to 6 ft. showed that the height of wave crest above the mean (undisturbed) water surface varied between $0.67 h$

¹ Rep. Chf. of Engrs., 1889, II, 1319.

and $0.89 h$, with a mean value of $0.76 h$. A gently-sloping bottom or an opposing wind increased the height of crest; a steep slope or a favoring wind decreased it.

Considering only a well-defined wave, breaking in water of a depth equal to its height from hollow to crest, the maximum effect (recorded by dynamometer readings) was found at a distance above the water surface equal to about $\frac{1}{6}$ of the wave height, from which point it decreased to zero at a distance above the water surface equal to about one-fourth of the wave height."¹

Undertow. — Since the water is being piled up against the shore by the waves some provision must be made for its return, and this is done by the undertow. This is a permanent outward current normal to the coast line, of pulsating character.

Another function of the undertow is to dispose of material eroded by the waves by conveying it seaward, and it also helps to scour the submerged shelf across which the waves are eating their way into the land.

If a wave approaches the shore at an angle, there will be a tendency for it to start a *shore current*, and the drift thus set up is a strong factor in the transportation of sediment along shore.

Thus in Fig. 173, the line ab represents the direction of the incoming wave, bd the direction of undertow, and bc direction of shore current. A particle of sediment affected by both shore current and undertow would tend to move in the direction be , which represents the resultant of the two forces. But the next incoming wave would move it in the direction ab again. It would therefore migrate in the direction bc , but follow a zigzag path in doing so.

Work Performed by Waves

The work accomplished by waves in general may be classified under (1) erosion, (2) transportation, and (3) deposition.

Erosion. — Waves beating against the shore perform erosion, chiefly by the impact of the water and by the débris which the water carries, as well as in other less important ways. The impact of the water alone may cause considerable erosion if the coast line is of weak or unconsolidated material, or if the rock consists of alternating weak

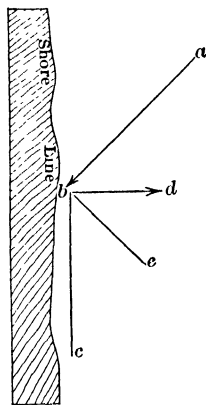

FIG. 173. — Diagram showing relative directions of wave (ab), undertow (bd), and shore current (bc). Particle carried in by wave in direction ab , but by undertow and shore current action on it, in direction be . (After Chamberlin and Salisbury, Geology, I.)

¹ Lt. Gaillard, Rep. Chf. of Engrs., 1891, III, 1627.

and strong material, the removal of the former may leave the latter unsupported, and cause it to collapse.

Forcing of the water into joint planes and other similar spaces can produce hydraulic pressure, sufficient to disrupt the rock if it is weak, especially when due to weathering. Very little effect is accomplished by waves of clear water, on solid, hard and fresh rocks.

Storm waves especially strike a blow of tremendous force. Stevenson in conducting a series of experiments on the force of breakers, found that the average force on the Atlantic coast of Britain was 611 pounds per square foot, while in winter it was 2086 pounds. The greatest efficiency is shown in bold coasts, bordered by a broad stretch of deep water.

The erosive work of waves is greatly augmented by the débris which the waters are able to move. Thus sand, pebbles, and stones moved by the waves, not only serve as weapons of attack against the coast itself, but also help to break down loose rock fragments too large for the waves themselves to move.

These large fragments gradually become worn down by the detritus which is moved back and forth over them, until they are finally small enough for the waves to handle and hurl about, using them in turn as cutting tools.

The effectiveness of the waves will depend on their strength, and also on the concentration of their blows. The former is dependent on: (1) Strength of wind, (2) depth of water, and (3) expanse of water across which wind can sweep. The latter is dependent on the slope of the surface against which they break.

Stevenson and Harcourt give numerous examples of the power of waves in deep harbors and exposed situations. Examples of wave action on our own more protected coasts and in our shallow waters are not so numerous. In the report to the Chief of Engineers of 1890 on the Improvement of St. Augustine Harbor is the following:

“ A wave may act on the jetty directly, by a blow, or a push, or a blow and a push combined; and, indirectly, by a pull, by compressing the air in the voids of the masonry, by upward pressure due to the difference of head produced on the two sides of the jetty, or by a combination of these actions. The direct action measured on the dynamometers had effects equal to pressures varying between 190 and 753 pounds per square foot. This action took place when a wave broke directly on or in advance of the jetty; this also compressed the air in the voids of the jetty. . . . Jets of water and sand were sometimes projected up from the cracks in the jetty to some height. The maximum height of any wave observed striking the work was 6 ft. . . . Up to a height of about 2 feet above mean low water, rip-rap weighing 40 to 50 lbs. was but little disturbed. Above this limit, to the height of 10 ft., the highest point observed, rip-rap varying in weight from 40 to 200 lbs. could not be

held at any slope. An isolated piece of concrete weighing 350 lbs. and resting on its flat base 0.7 sq. ft. in area, with its center of gravity 7 ft. above mean low water, was moved several feet by breakers whose crests were above $7\frac{1}{2}$ ft. above mean low water. These breakers measured $3\frac{1}{2}$ ft. from hollow to crest. . . . All that portion of a mound or wing, composed of rip-rap (varying in weight from 40 to 220 lbs.) tightly chinked with oyster shells, lying between 4 and 6 ft. above mean low water, no matter what side slopes the rip-rap was given, would be carried away in a single tide whenever breakers greater than 4 ft. in height struck it fairly. . . . A block of concrete weighing 527 lbs. was elevated 1.3 ft. by the action of a single breaker. During the same tide it was moved 23 ft. in-shore. A dynamometer within 8 ft. of its original position recorded a maximum pressure of 575 lbs. per square foot during this tide. A piece of concrete weighing 200 lbs. was lifted vertically to a higher level than that of the water surface by a wave which broke just in front of it. Another block of concrete weighing 1,600 lbs. was lifted from its bed vertically at least 14 ins., and then moved several yards."

Later, a concrete block $10 \times 6 \times 2\frac{1}{2}$ ft. and weighing dry 21,000 lbs., lying at about the mean low water line of the beach, was lifted vertically 3 ins., and there caught and held fast. The maximum wave height and dynamometer reading during that gale were 5.5 ft. and 633 lbs., respectively.

Another familiar effect of wave action was shown at Sandy Hook where a line of rip-rap placed at the ordinary high water line, composed of blocks weighing from 300 lbs. to 3 tons, was undermined and sunk into the sand from 4 to 6 ft. It may be stated generally, that where an obstruction is placed on a sand beach between high and low water, if it is too heavy to be moved, the resultant effect will be to smooth off the beach, either by sinking the object, or by building the beach over it.

Vertical range of wave action. — The range of wave erosion is as restricted vertically as it is horizontally, but it may be extended somewhat by the rise and fall of the tide. The efficient impact of the wave is limited by the crest above and the trough of the wave below. The range indirectly, however, is often great, being limited by the height of the shore only, for by the under-mining of a cliff, a considerable mass of material may be brought down. This fallen mass will temporarily protect the shore against wave action, until it is broken up and disposed of. Frost also dislodges more or less rock and soil from the face of sea cliffs.

Recession of coast. — As a result of wave attack, the sea sometimes encroaches on the land, and protection walls are necessary in order to prevent the destruction of buildings, roads, railway tracks, *etc.*

This recession may be especially rapid on sandy coasts, such as that of New Jersey, and many different forms of walls, bulkheads and jetties have been constructed by riparian owners with varying results. In some cases failure is due to improper type of protective work, in other cases it may be due to lack of concerted effort at different points along the shore.

Incidentally, it has been found that conditions at a given point sometimes become reversed, so that erosion stops and deposition begins. Thus Haupt¹ describes a case at Hereford Inlet and Five-mile Beach, where he states that "a substantial bulkhead, built about 1890 at Five-mile Beach to protect Wildwood and Holly Beach, was carried away, and that the island had wasted some 600 feet, when, without apparent cause, the sea began to deposit and the beach to gain its former position. Upon investigation as to the cause, it was found that Hereford Inlet (Plate LI), at the head of the island, had drifted to the south 1000 feet in the past ten years and the shore in front of Anglesea had advanced some 1500 feet in consequence. This deposit projected the ebb tide farther out and caused an eddy current which cut away the beach to the southwest of the shoal, as was the case at Absecon Beach prior to 1850, when the shore was close to Pacific Avenue."

Wave Cut Topography

Cliff and terrace.—Waves cutting into and undermining the shore at the water level develop a *sea cliff*, whose slope will depend on

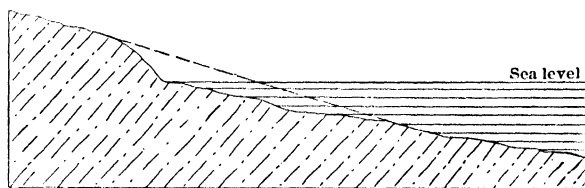

FIG. 174. — Section of wave-cut terrace in gentle slope. (After Gilbert.)

the character of material and rate of cutting, and where height will depend on the height of the land on which the sea advances.

At the base of the sea cliff there is a submerged shelf, covered by shallow water, the *wave-cut terrace*. (Fig. 174.)

In some cases the land has been elevated since the terrace was cut, so that it is now preserved as a bench above sea level, as for example on the coast of southern California.

Coast outline.—The outline of a coast as developed by wave erosion depends on the character of the rock, its structure, and original outline. The following cases may be cited:

1. A regular coast, equally exposed, but of unequally resistant material, is made more irregular by wave action, resulting in the develop-

¹ N. J. Geol. Surv., Ann. Rept., 1905, p. 70, 1906. The same report contains many other examples.

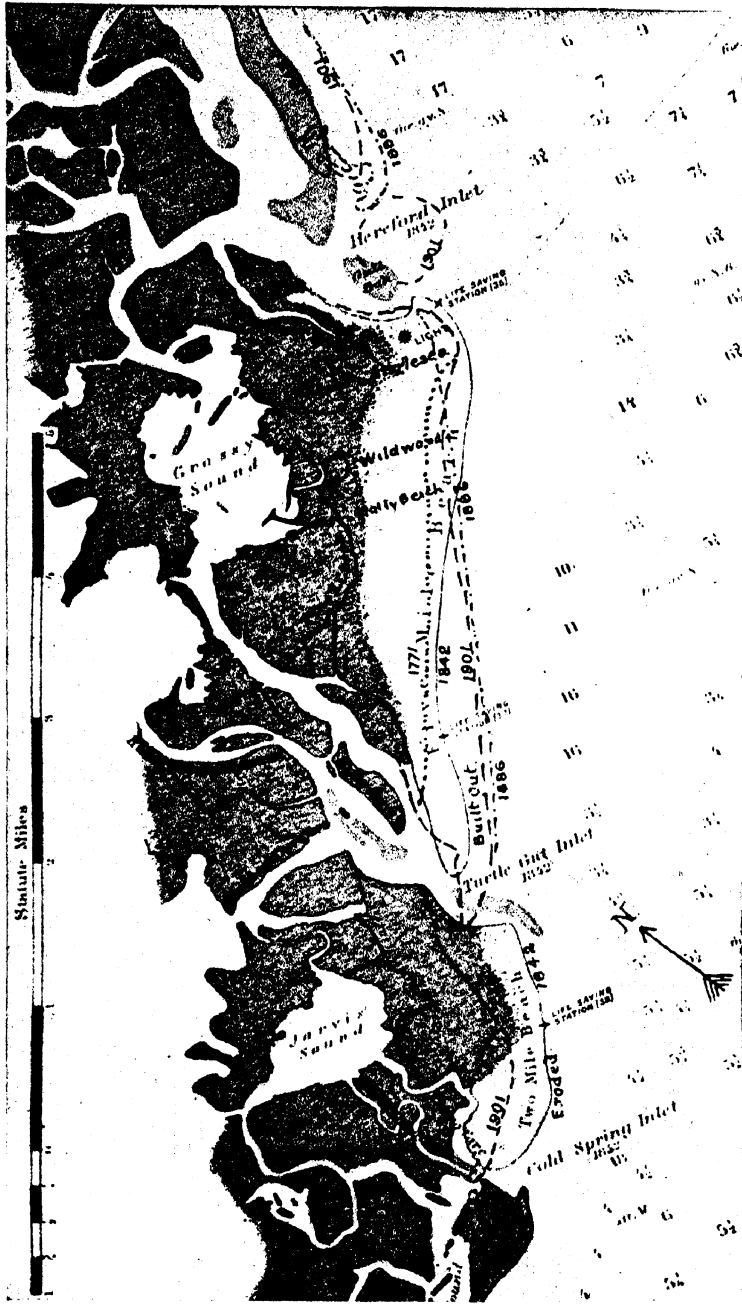

PLATE LI. — Changes at Hereford Inlet, and Five-mile Beach, 1771 to 1901. (After Haupt, N. J. Geol. Survey, Rept., 1905.)
 (384)

ment of headlands where the rock is hard, and indentations or bays where the materials are soft, or much fractured, so as to be easily eroded.

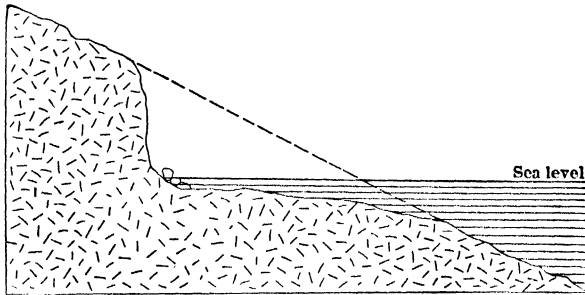

FIG. 175. — Section of wave-cut terrace on steeply sloping coast. (After Gilbert, U. S. Geol. Survey, 5th Ann. Rept.)

2. A regular coast, unequally exposed, but of uniform material, becomes more irregular.

3. An irregular coast, of uniform or homogenous material, becomes more regular.

Transportation by shore currents. — The incoming waves tend to shift material toward the shore, especially inside the line of breakers, while the undertow tends to carry it out (seaward) again. If the waves strike the shore obliquely, the particles of sediment follow a zig-zag path along shore — the direction of littoral or shore current. Coarse materials accumulate where the disturbance of the water is greatest, while finer material is moved even when the water is less agitated.

The coarse material covering the bottom, in shallow water along shore, or where agitation reaches the bottom, is termed the *shore drift*. It may include either material derived by wave action or that delivered to the sea by streams.

Shore Deposition Topography

Beach and Barrier. — The *beach* (Fig. 176) is the belt or zone occupied by the moving shore drift, and it may have a variable width. The upper margin is the level reached by storm waves; its lower margin is slightly beyond the breaker line of storm waves. While the beach follows the water and land boundary in a general way, still it does not conform to all the minor irregularities, such as indentations and projections.

If the slope of the coast is flat, then the undertow is weaker than the shoreward movement of the waves, and the material is shifted

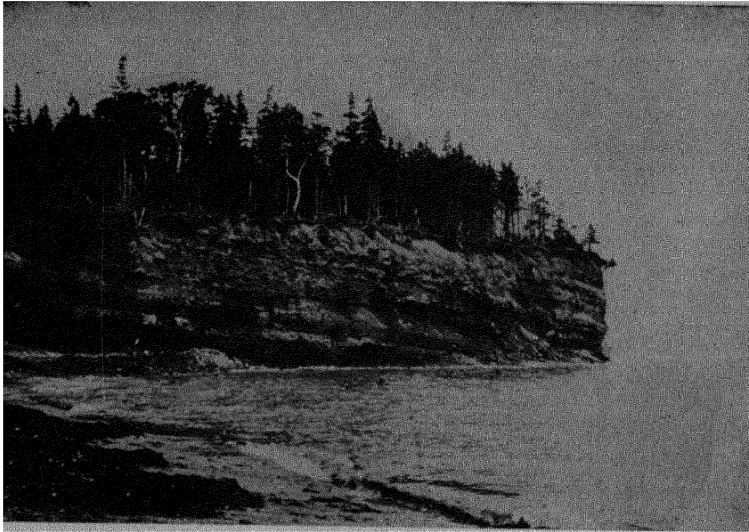

PLATE LII, **FIG. 1.**—Cliffs formed by wave action, Sydney, C. B. (H. Ries, photo.)

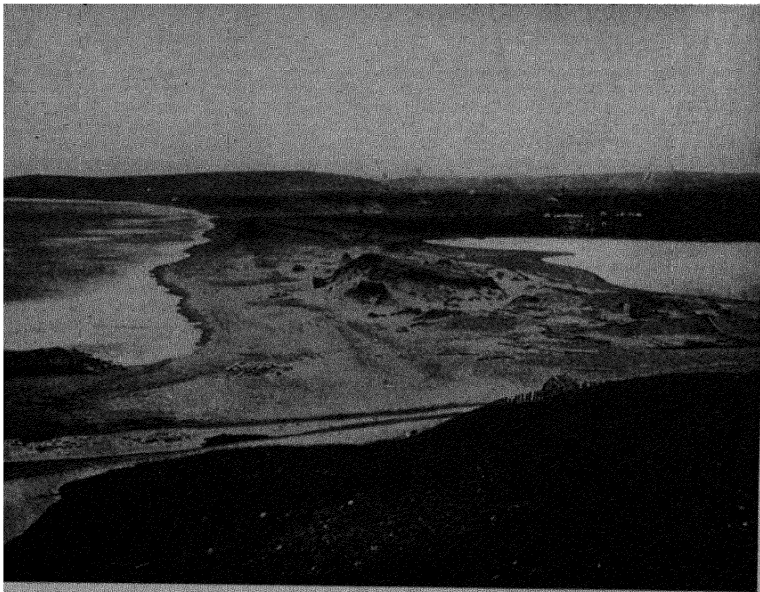

FIG. 2.—Beach and sand dunes formed by wave and wind action across harbor of Inverness, N. S. (H. Ries, photo.)

shoreward, being cast up near the water's edge and forming a beach ridge (Fig. 176).

If the sea or lake bottom near shore has a very gentle slope, the waves break some distance out from the shore line, and it is at this point of

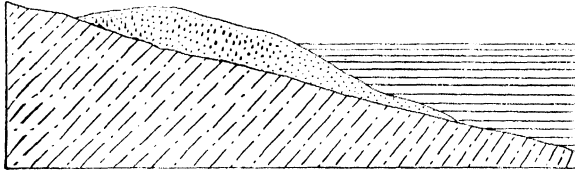

FIG. 176. — Section of a beach ridge. (After Gilbert.)

greatest agitation that deposition takes place, and a ridge may be built up known as a *barrier beach* (Fig. 177). If now the storm waves build this up above the water surface, a lagoon is formed between the barrier and the main land, which may eventually become filled by sediment

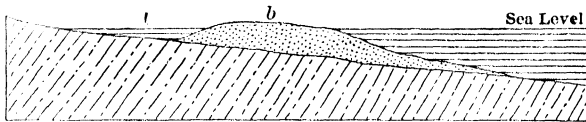

FIG. 177. — Section of a barrier beach; *b*, barrier; *l*, lagoon. (After Gilbert.)

(Plate LIII). The lagoon at one stage of filling becomes a marsh. Most of the material is washed in from the land, but some may be brought in by tidal currents.

Barrier beaches are not only liable to shift (Fig. 178), but are sometimes of considerable width. At Atlantic City (Plate LIII), on the

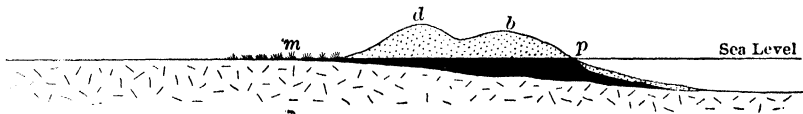

FIG. 178. — Section of a barrier beach which has moved inland, part way across a marshy lagoon. *b*, barrier; *m*, marsh; *p*, peat; *d*, dune. (After Goldthwait, Ill. Geol. Survey, Bull. 7, 1908.)

coast of New Jersey, a barrier one mile broad has formed and at present is growing on the seaward side, although formerly it was eroded at different periods.

The sand which is piled high on either a beach or barrier is not allowed to rest, but is carried by the wind and heaped up to form sand dunes



PLATE LIII. — Map showing barrier beach and partly filled lagoon behind. (After Kummel, N. J. Geol. Survey, Rept., 1907.) (388)

(Chapter II). An artificial barrier will sometimes cause a dune 10 feet high to build up in one season.

Spits, hooks, and bars. — The littoral or shore current does not follow the larger indentations of the coast. In maintaining its course across the mouth of a bay, the current may pass into deeper water. This would result in checking the velocity of the current, and the deposition of a part at least of the sediment it was carrying.

The deposited material assumes the form of a submerged ridge, usually narrow, across the mouth of the bay, and is termed a *spit* (Fig.

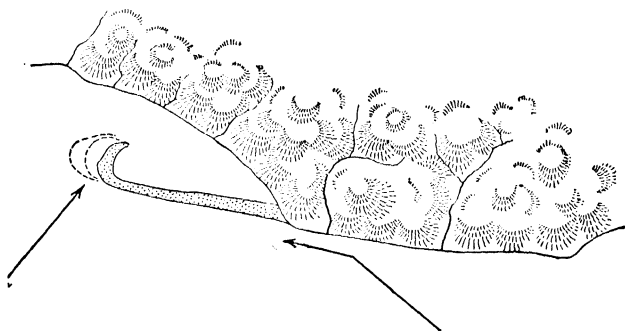

FIG. 179. — Sketch map showing the development of a hooked spit. (After Goldthwait, Ill. Geol. Survey, Bull. 7, 1908.)

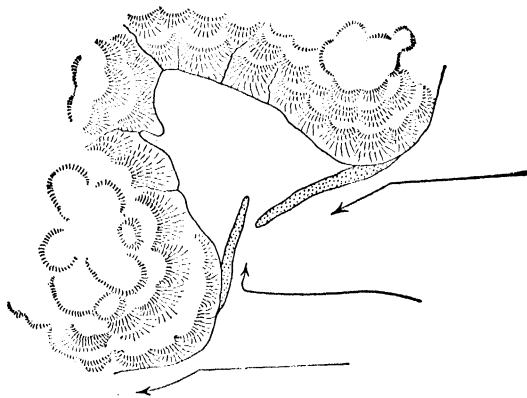

FIG. 180. — Sketch map showing a bay enclosed by a pair of overlapping spits. The arrows indicate the direction of the wind-driven currents. (After Goldthwait, Ill. Geol. Survey, Bull. 7, 1908.)

179 and Plate LIV), so long as it is free. As the level of the ridge is built up towards the water surface, it comes within the zone of agitation of the waves, and by these it may be built up above the surface of the

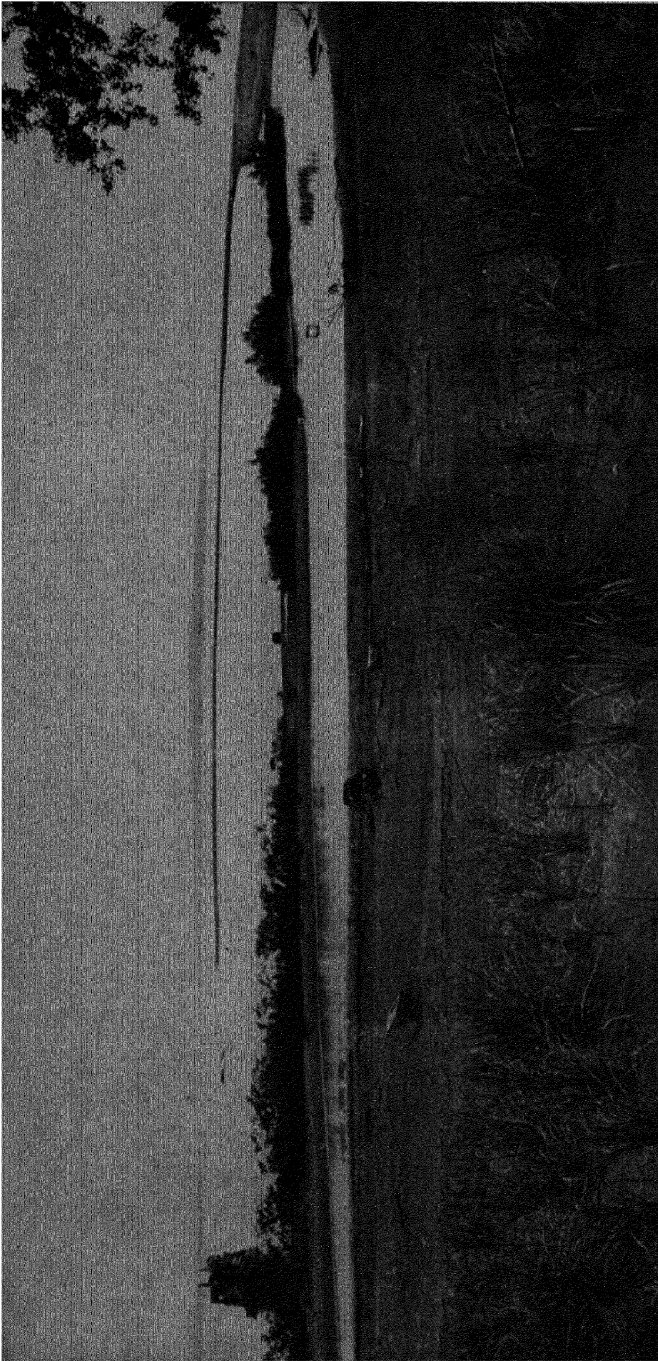

PLATE LIV. — Hooked spit of sand, mouth of Ausable River, Lake Champlain, N. Y. (H. Ries, photo.)
(390)

water. Spits are also at times built out from projecting spurs of the coast line.

A strong current, even of temporary character, flowing past the end of the spit, may cause it to curve into a *hook* (Figs. 179 and 180, and Plate LIV), and this will occasionally change its position because of change in the direction of the wind.

If the spit completely crosses a bay and becomes tied to the opposite shore it is called a *bar*, and many lakes have been formed by the up-building of a bar across the mouth of a bay. Bars sometimes tie islands to the mainland.

Conditions are frequently quite different where an active stream enters the bay, for then the outflow from the bay may be strong enough to prevent the completion of the bar.

At other times the growth of the raised spit across a bay may gradually shift the stream channel towards the farther side of the bay, considering direction of shore drift. If the ridge building still encroaches

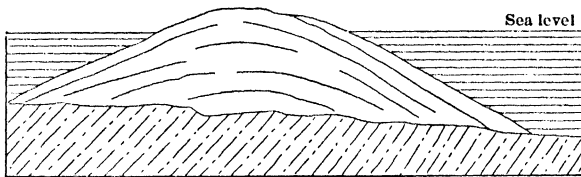

FIG. 181. — Section of a bar. (After Gilbert.)

on the stream channel the latter may break through the spit at another point, but if the stream is completely blocked the water may seep out through the beach gravels.

Plate LII, Fig. 2, shows an interesting occurrence at Inverness, Nova Scotia. Here the small harbor which was to have been used for shipping coal from the neighboring mines became completely closed by a bar of shore drift from the north. The stream flow was too weak to keep a channel way open across the bar, and dredging was equally ineffective. Jetties which were constructed became buried in the drifting sand. In addition the wind picked up the sand from the upper edge of the beach and piled it into dunes.

Tidal scour is another factor tending to maintain a channel way (*thorofare*) across a spit or barrier beach. Sediment brought in by the tidal current is sometimes deposited inside the entrance forming a shoal, which is obstructive to navigation.

Although shore drift may move in opposite directions at different

times, there is usually a positive resultant in one direction, and the determination of this is of importance in bar improvement.

The tidal wave can produce a current which is separate from the littoral (shore) current.

Examples of changes in shore line. — Figs. 182, 183 and 184 illustrate well the changes that may take place along coast lines by wave and current action.

Figure 182 shows simplification of shore line by deposition (and subordinately by erosion), where the coastal bars deposited by waves and shore currents have closed in a series of bays, converting them into ponds.

Little water enters these ponds, but what does, finds its way into the sea by seepage through the sand and gravel of the beach. The only permanent stream is that entering Tisbury Great Pond, and the inflowing water seems to be sufficient here to keep an outlet across the beach. Bars or beaches seem to be in process of development south of Katama Bay, and may in time connect with each other unless the tidal flow between Edgartown Harbor and Katama Bay is sufficiently strong to keep the passage open. The material for building the bars was probably cut from points of land which formerly projected into the water.

Figure 183 represents a shore line where both erosion and deposition are going on. Material eroded by wave action from the cliffs along shore to the south is carried northward by the shore currents and has been deposited to form a bar across Morro Bay. The beach formed on this bar by wave action has been piled up still higher by the wind to form sand dunes. At the head of Morro Bay a delta is being built and is gradually encroaching on the water of the bay.

Morro rock is an island presumably isolated from the main land by subsidence, by wave erosion, or by both. The drainage entering the bay tends to prevent the completion of the bar.

Figure 184 shows the development of coastal irregularities by processes which will ultimately result in coast simplification. Material eroded from the coast by wave action to south of limit of map is carried northward by shore currents. The beach built with this sediment terminates in Sandy Hook at the entrance to New York harbor. The Hook turns westward because of strong wind, waves, and tidal action from the east. At the northwest end of the shore line the coast line is being built out by sedimentation. This part of the coast is protected from strong wave action by Sandy Hook. The north border of Highlands of Navesink is marked by cliffs, formed by wave erosion prior to the existence of Sandy Hook. The bays marked as Navesink River and Shrewsbury River are probably the result of subsidence which has drowned the lower ends of these rivers. The building of the bar across their mouths is another illustration of the process of coast simplification.

Work of tides. — While the work of the tides is of much less importance than that of the waves, it is not by any means to be overlooked.

The tide is a great wave produced by the attraction of the Sun and Moon, which travels around the earth once every 24 hours, but since two waves are formed on the opposite sides of the earth a tidal wave passes any given point about every 12 hours.¹

¹ So-called tidal waves which roll up on the shore following some earthquake shocks, have no connection with true tidal waves. They are caused usually by sudden displacements of the sea bottom.

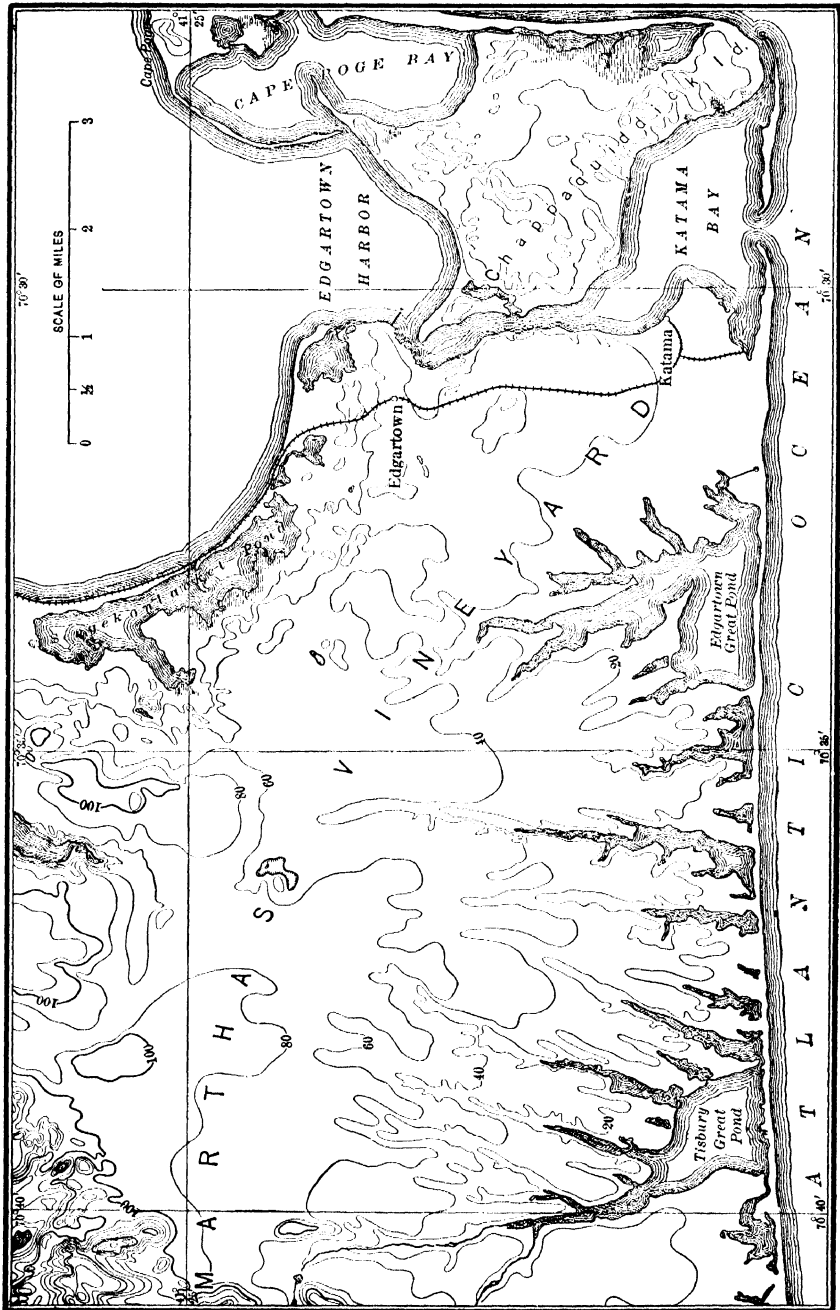
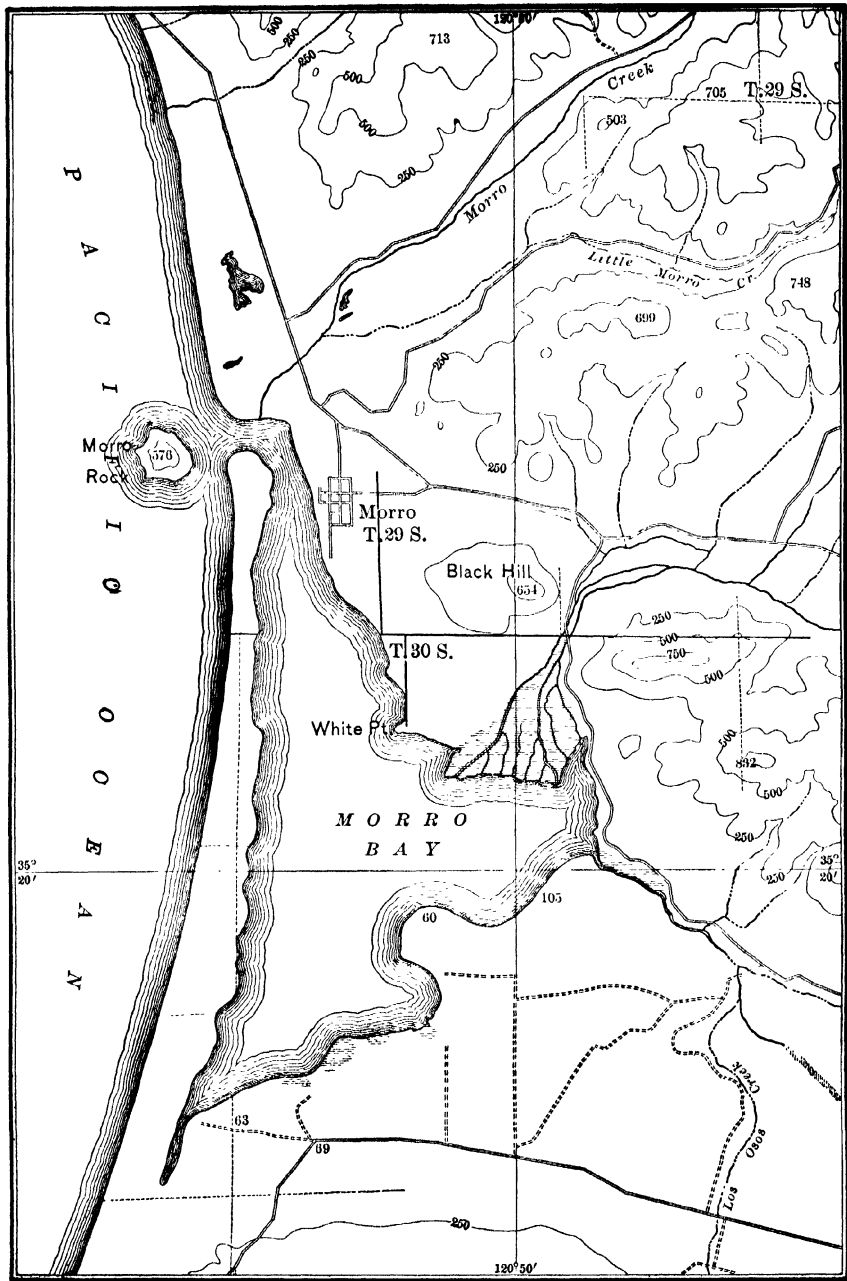

FIG. 182. — Beach deposits in vicinity of Marthas Vineyard, Mass.
 (U. S. Geol. Surv.)



(394) FIG. 183. — Shore deposits at Morro Bay, Calif. (U. S. Geol. Surv.)

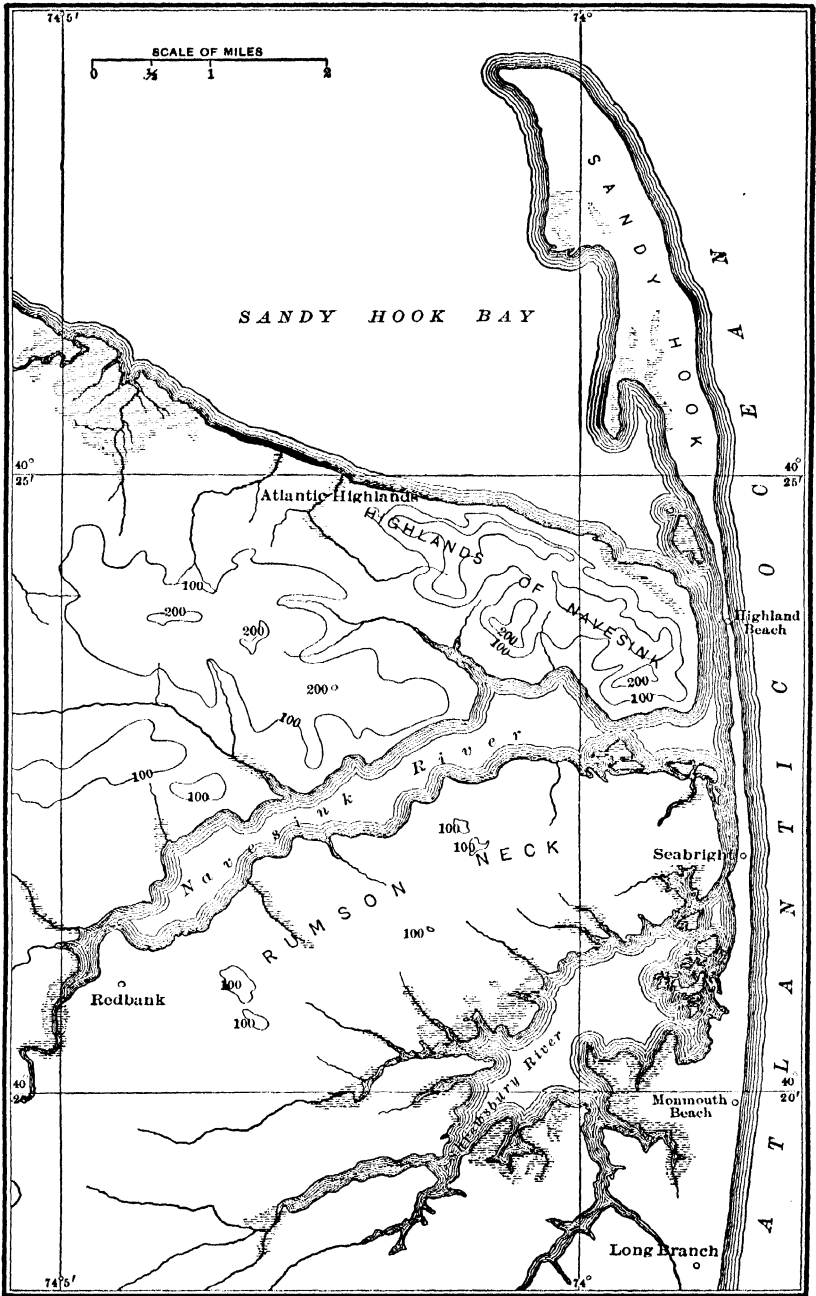

FIG. 184. — Shore line modifications in vicinity of Sandy Hook, N. Y. harbor. (395)

On the open sea this wave is not noticeable, but when it reaches the coast line of the continents the water is raised up, giving *high tide*, and as the wave passes on, the water level falls, giving *low tide* conditions.

The work of the tide is especially noticeable where the water flows through narrow openings in barrier beaches, between islands, or enters some bay which narrows towards its head. In the latter case, of which the Bay of Fundy is a good example, the tide advances up the bay as a wave known as the *bore*, and causes a tidal rise in places of 40 to 60 feet.

Tidal currents show a varying velocity of from 1 to 12 miles per hour, and where they are flowing through narrow passes it can be seen that they may not only cause trouble to navigation, but will, if the channel-way is of unconsolidated material, also cause considerable scouring. The material thus removed by erosion may be deposited locally as at the head of bays, in lagoons behind barrier beaches, or in harbors.

It is stated that Boston harbor has been filled to a depth of 25 feet with tidal silts, and much red silt has been deposited at the head of the Bay of Fundy.

Problems of Harbor and River Mouth Improvement

Relation of wave and shore current work to harbors. — From what has just been said the engineer will readily observe that harbors can be closed or silted up, or bars formed which shallow the channel, and hence in many cases preventive measures are necessary to combat the work of wind and waves.

Equally important to recognize is the fact that many of these features are of very temporary character. Spits, bars and thorofores shift at times with remarkable rapidity as a result of storms.

The best channel across an outer bar shifts leeward, while immediately abreast of the inlet, both inside and out, the greatest sand deposition takes place. In tidal inlets the full prism of the flood should be admitted to the inner bays, so that the ebb may have sufficient volume to maintain the size of the entrance.

The coast of New Jersey affords some excellent examples of the above, and the following quoted from the State Geologist's report is highly illustrative.¹

The coast of New Jersey from Sandy Hook to Cape May is of great importance in many respects, because it forms the southern approach to New York Harbor, and along the 134 miles of coast from Sandy Hook to Delaware Breakwater there have been more disasters than on any similar length of coast line of the United States.

"It is difficult to one unfamiliar with the action of waves and currents to appreciate what great changes may be wrought upon the beaches during even a single storm, or by slow accretion at one locality and equally slow wasting at another.

¹ N. J. Geol. Survey, Ann. Rept., 1905.

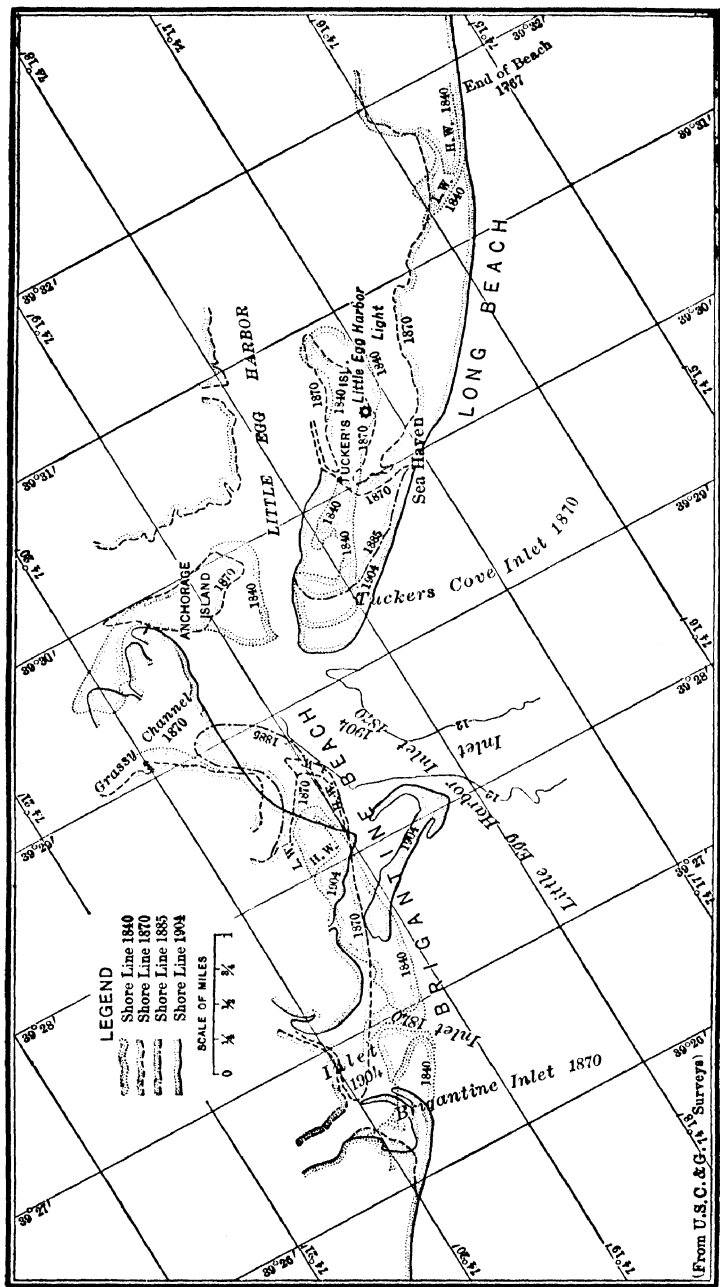

Fig. 185. — Map showing changes in the shoreline between Brigantine and Little Egg Harbor Inlets, N. J., between 1840 and 1904. (After Haupt, N. J. Geol. Survey, Rept., 1905.)

The channels of the inlets are constantly changing in depth and location through certain cycles and the inlets themselves are slowly shifting in position.

"Much money has been spent, with comparatively little result, due in part to the absence of any concerted action embracing considerable areas and in part to improper plans followed."

Case of Manasquan Inlet (Fig. 186 and Pl. LV).¹—"With the exception of Shark River, Manasquan Inlet is the only opening remaining in the fifty-three mile stretch of coast from Sandy Hook to Barnegat Light. It has ruling depths at low water of about three feet or less, with constantly shifting channels, which have at intervals been entirely closed.

"It has a drainage area of 80.5 square miles, while the immediate tidal basin covers almost exactly 2 square miles. With this small ratio between land and sea-water area, and with the mouth closed by a bar, it would be only a short time before the 6-mile reach constituting the basin would be converted into a freshwater lake, with an uninterrupted outflow to the great detriment of the country. To preserve its maritime features, it is vital that as much sea water be admitted as possible, and to prevent gradual shoaling, the tidal currents should be maintained to their fullest extent, without causing too great velocity in the engorged sections.

"These results will be accomplished best by admitting as large a volume of the flood tide at the gorge as may be consistent with the physical conditions and riparian interests, and at the same time by so guiding and concentrating the movements of the ebb tide as to create a scour and consequent deepening across the outer bar. Works which throttle the tides and violate the fundamental condition of letting in the largest available amount of water in order to maintain the currents which are the main factors in cutting out the channels at ebb tide must result only in injury.

"The physical features at this inlet are typical and suggestive of the appropriate remedy. Here are found the prevailing northerly, littoral drift; the angular wave movement, also working to the north; the inwardly-curving south spit; the large inner, middle ground; the crescent-shaped outer bar, lying close in shore, the diverse channels for the flood and ebb movements, and the deep holes or pockets caused by the reaction of the currents upon obstructing barriers of sand or wood.

"Reference to the accompanying map (Fig. 187) will show a jetty on the north side about 1500 feet in length, one of two built by the United States government in 1882. That portion of the inlet and bay adjacent to the jetty has an average width of nearly 1000 feet and contains, approximately, 35 acres, of which about 13 acres are bare at low water, while the balance is too shallow for anchorage for coasters.

"Near the outer end of the jetty, there is a small pocket having a depth of 10 feet for a width of about 100 feet.

"The *south spit* of sand projecting into the throat of the inlet and forming what is known as the *gorge*, is increasing in extent and curving inward by the deposits carried up by the flood tide so that at low water, the channel is reduced to only 260 feet in width and its cross-sectional area is but 1260 square feet.

"With a 3-foot tide, this sectional area would be doubled, but the duration of high water is very short and the current velocities are reduced to nothing. By the improvement proposed and shown on the plan, this cross-section at "D-E," as well as the one on the crest of the outer bar, will be more than doubled, thus admitting

¹ Quoted from report by L. M. Haupt, N. J. Geol. Survey, Ann. Rept., 1907, p. 72, 1908.

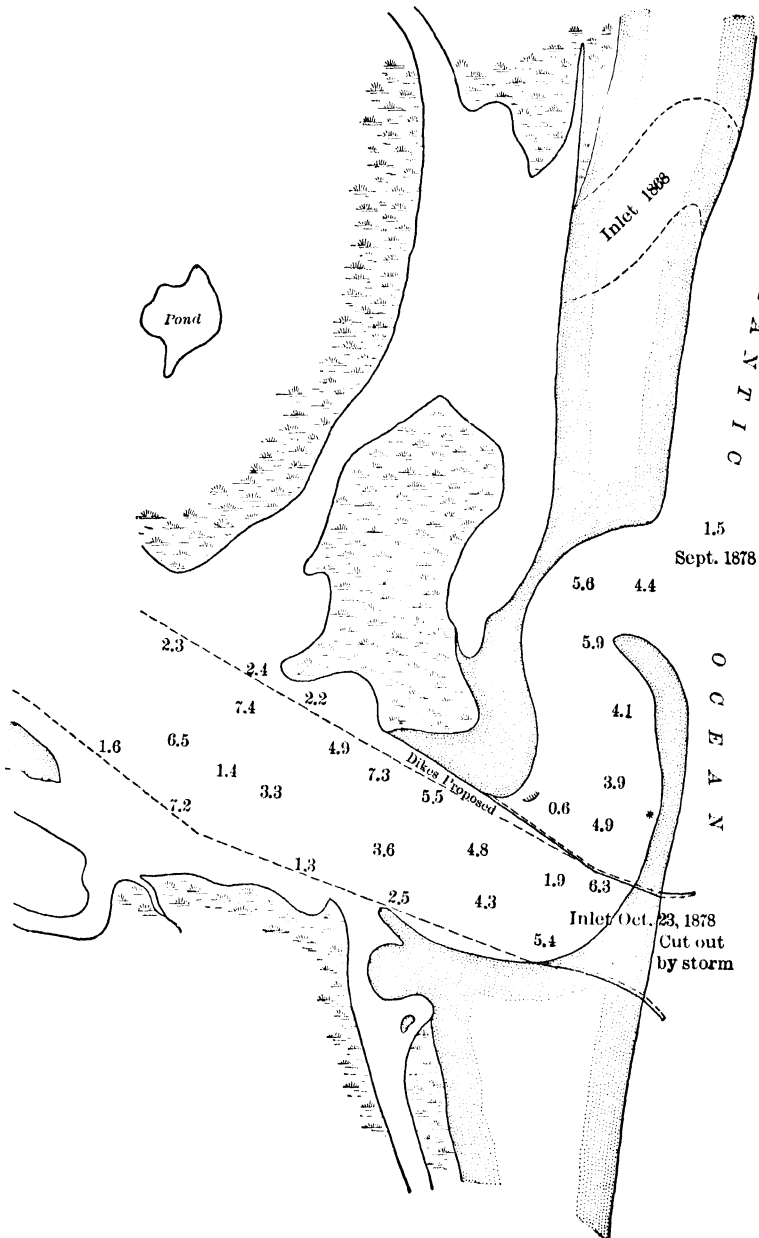

FIG. 186. — Map of mouth of Manasquan Inlet, N. J., September, 1878. (N. J. Geol. Survey, 1907, Rept.)

more water at each tide, increasing the velocity of the currents and creating greater and more permanent depths of channel.

“The south spit and inner-middle ground not only interfere with the incoming tide, with its load of sand, but by checking its velocity they invite deposits in the harbor.”

As evidences of the changes at this inlet reference should be made to Fig. 186, which is from the U. S. Government chart for 1878 and shows three positions for the inlet, from which it appears that the mouth was drifting southward.

Relation of bars to rivers. — Bars¹ are found at the mouths of many rivers, and may be built up in part of river sediment and in part of sediment brought in by waves and tidal currents.

If a sediment-laden river, like the Mississippi, Nile or Amazon, enters directly into the sea or lake, checking the velocity of the current as it meets still water, will cause it to drop its load of sediment, thus forming a bar.

On the other hand, bars at the outlets of lagoons or bays which empty into tidal seas, and which receive the flow of a river, are caused chiefly by the action of the winds and waves, which drive material into and across the mouth. The tidal currents, however, keep the mouth from being closed. In such cases, little actual river silt probably reaches the bar.

In the case of rivers which discharge through a tidal estuary, the bar may be due to conflict of ebb and flood currents at the outfall, which cause eddies and still water; or to the difference in duration of their scouring action; or to waves and sand drift along the shore.

“The operation of the laws² governing the formation and the improvement of the outlets of rivers and tidal harbors is usually complex and difficult of any close analysis. The forces at work are generally many and varied, and while the effect of a single one upon a plan for improvement might be foretold, their action in combination can only be approximated.

“There are, for example, as just mentioned, the transportation and deposit of sediment, present in most rivers; the effect of floods and tides; the presence or absence of currents along the coast; and the gradual effects of storms and the drift of shore material, which with small rivers may change the outlet entirely, as with the Yare River on the east coast of England, where the outlet was driven south 4 miles in the course of years, and at Aransas Pass in America, which has moved to the southwest about a mile in the past 50 years. In some cases such

¹ For detailed discussion of this subject see Thomas and Watt, *Improvement of Rivers*, 2nd ed., part 1, p. 309, 1913. (Wiley & Sons.)

² Thomas and Watt, *l.c.*, p. 310.

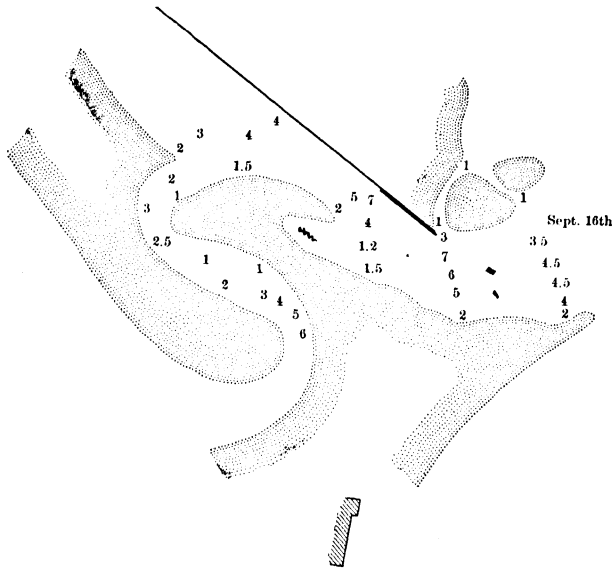

FIG. 1

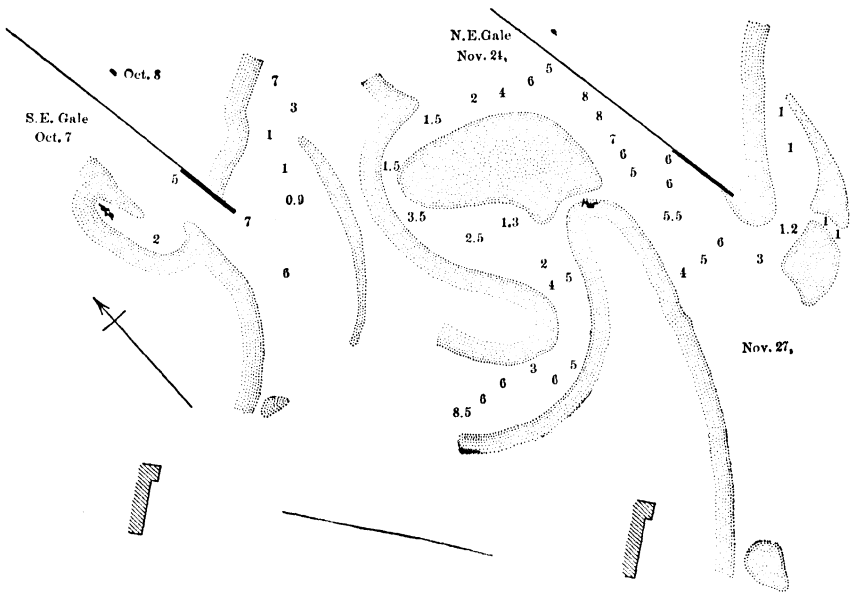

FIG. 2

FIG. 3

PLATE LV. — Maps showing changes at the mouth of Manasquan Inlet, in the year 1907. Fig. 1, Sept. 6; Fig. 2, Oct. 8; Fig. 3, Nov. 27. (After Haupt, N. J. Geol. Survey, Rept., 1907.)

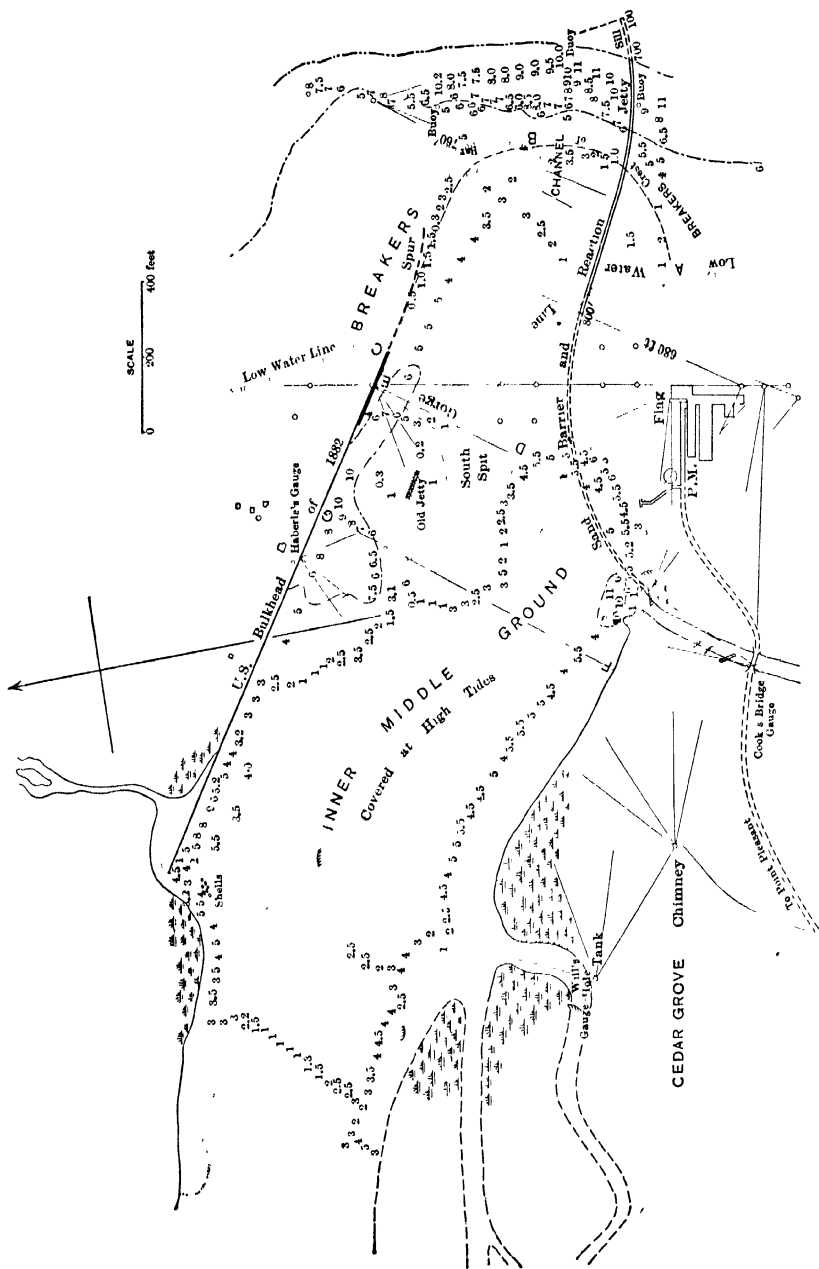

Fig. 187. — Survey and plan for the improvement of Manasquan Inlet, N. J. (After Haupt, N. J. Geol. Survey, 1907, Rept.)

causes produce daily changes in the channel, as with the Hoogly, where ships can navigate only in daytime and by constantly taking soundings."

However, close study of the charts of different periods may indicate the existence of certain persistent forces at work, a knowledge and recognition of which will enable the engineer to attack the problem more intelligently.

Rivers which enter tidal estuaries have to be treated differently from those which have non-tidal outlets, without shore currents, or where these currents are slight.

Improvement of tidal rivers. — In improving tidal rivers the following principles have to be borne in mind:¹

(1) "The tidal flow should be admitted freely up the river as far as possible in order to reduce period of slack water to a minimum. In this way the area of inevitable deposits is enlarged and there is not an excessive accumulation at one point in the channel when the fresh-water discharge is small. Moreover the volume of tidal water flowing from the outlet is increased.

(2) The fresh-water discharge should be maintained as large as possible, and not abstracted for canal and other purposes so that it can have the fullest possible effect in reinforcing the ebb throughout the whole of the tidal course of the river and thus keep the channel scoured.

(3) The form of the estuary should be regular if possible so as to enlarge gradually as it approaches the sea, and thus promote regularity of flow without restricting the tidal capacity above the outlet."

This is sometimes accomplished by low training banks which, while directing and concentrating the latter half of the ebb, do not materially impede the admission of the flood tide up the estuary. Where the estuary is very wide and irregular and the main river channel through it is very tortuous and shifting, high embankments may be formed on each side widening out towards the sea and the land behind them reclaimed.

In non-tidal rivers or those where the range of tide is very small, the principles governing them are somewhat different because of the lack of tidal influences capable of affecting the maintenance of their outlets, and because of the difference in form of the mouths themselves.

Here the stream flow is always in the same direction and on being checked at its mouth deposits sediments, thus gradually building up a bar which forces the water in various directions through separate outlets across the foreshore and forms what is known as a delta.² The development of several arms or outlets tends to reduce the scouring effect of the currents and the channels become too shallow for navigation by reason of the deposit of material brought down by the river.

Thus deltas gradually extend into the sea as this material is progressively deposited at the mouths of the outlets. Mr. Vernon-Harcourt lays down the following principles for improving non-tidal outlets without shore currents or where the currents are very slight.

"(1) The only method of deepening the outlet of sediment-bearing rivers flow-

¹ Mr. Vernon-Harcourt quoted by Thomas and Watt, *Improvement of Rivers*, Vol. 1, p. 310.

² See *Chapter on Rivers*.

ing into tideless seas is to prolong one of their delta channels by parallel jetties out to the bar, so that the prolonged current, being concentrated across the bar, may scour a deeper channel, and carry its burden of sediment into deep water further out.

(2) One of the minor outlets should be selected for improvement, if its delta channel is adequate, or can easily be made adequate for the requirements of navigation; and the discharge of the other outlets should not be interfered with. The advance of the delta at one of the minor outlets is slower, and the distance out to the bar is less, and consequently the jetty works are less costly; whilst an increased discharge, produced by impeding the flow through the other outlets, would also increase the volume of sediment, and therefore quicken the rate of advance of the delta, and hasten the necessity of prolonging the jetties.

(3) The success of the jetty system depends on a rapid deepening of the sea in front; on the fineness and lightness of the sediment brought down; and on the existence of a littoral current, its velocity, and the depth to which it extends. Any erosive action of winds and waves along the shores of the delta is favorable to the system, and also any reduction in density of the sea-water, such as may be found in an inland sea.

(4) If the sea-bottom is flat; if a large proportion of the sediment is dense, so that it is carried along the bed of the river or close to it; if the outlet faces the prevalent winds; and if no littoral current exists, it is possible that an improvement of the outlet may not be practicable; and then recourse must be had to a side canal, starting off from the river some distance up, and entering the sea beyond the influence of the alluvium of the river.

(5) The bars in front of the outlets of tideless rivers being formed by the deposit from the river, vary in form according to the nature of the sediment brought down. When the material is composed of particles of very variable density, it is gradually sifted as the velocity of the current decreases and gives a flat sea-slope to the bar. When, on the contrary, most of the material is heavy, the bar has a flat river slope, as in the first case, formed by the gradual arrest of the sediment rolled along the bottom; but as little of the material is carried beyond the crest of the bar, the sea-slope is steep.

(6) The jetty system does not constitute a permanent improvement, for sooner or later, in proportion as the physical conditions are unfavorable or the reverse, a bar is formed further out, and a prolongation of the jetties becomes necessary.

The last rule would not apply if there were a prevailing wind which caused a shore current sufficient to carry away the silt as fast as it was brought out by the river.

The conditions at an outlet, moreover, are often complicated by the shifting of the channel due to the drift of sand along the coast or to disturbances produced by storms which in exposed outlets may block up a channel and cause a new one to open in a very short time.

Where the effect of the shore drift is small, the general tendency of the flow from the outlet appears to be along the shortest path to deep water, this being under ordinary conditions the line of least resistance and frequently nearly at right angles to the adjoining coast. In many cases there exist two main channels to the bar, in addition to the small side or swash channels which deepen and shoal alternately during the cycle of change and shift their location within a sector covering an angle of from 45 to 90 degrees.

This cycle of change may be illustrated by taking as an example an outlet whose limits of change lie between northeast and southeast and whose main channel

for the time being is the southerly one. After this channel has continued in existence for perhaps some years it will begin to shoal, possibly from a single gale or a period of gales, possibly from more obscure causes. At the same time the northerly channel will begin to open, and the closing of the southerly one will continue until it has become valueless for shipping. Usually more or less change of intermediate location occurs during this period, the channels sometimes wandering over a considerable portion of their field before the final shoaling or opening occurs. The northerly channel will then pass through a period as did the other and may shift further north deteriorating until the natural forces close it, and the water breaks open again along its first direction towards the south."

Shore drift. — "Where waves break in a considerable depth of water or where outside currents flow in a similar depth, the bottom appears to be slightly, if at all, disturbed; but where the depths are shallow the waves and currents will stir up and transport the material. Tests made in 1902 at Cumberland Sound showed that coarse sand and shell, when stirred up by breakers, were carried to a considerable distance even by light currents, and were not deposited till smooth water was reached. The same materials in quiet water lay undisturbed by currents flowing as swiftly as 4 feet per second, although fine sand was found to be moved by comparatively slight currents. This action on exposed coasts leads to a constant movement of the sand or shingle, and if the storms prevail in one direction, there will be a corresponding littoral drift. Where jetties or breakwaters are built under such circumstances there will result an erosion on the leeward side and a filling on the windward side, and this will continue until the latter is rounded out and the sand can travel past the ends of the jetties and continue its movement along the coast. The construction of breakwaters for the harbor of Madras led to an erosion of the neighboring coast for a distance of several miles to the north, in which whole villages were destroyed, and at the harbor of Ceara in Brazil, a similar erosion took place and continued for about three years, until the littoral drift had silted up the windward side and the entrance, and could pass along as before.¹ At the mouth of the St. John's River in Florida, the beach to the south was similarly eroded."

The four general methods used by engineers to improve navigable conditions at the mouths of rivers are:²

1. By lateral canals.
2. By dredging.
3. By jetties and dredging combined.
4. By jetties only.

¹ Proceedings, Inst. C. E., Vol. CLVI.

² For excellent discussion of this see Thomas & Watt, *Improvement of Rivers*, Vol. I, p. 314.

Case of the Columbia River, Oregon.¹ — “This river offers an interesting example of single jetty work. It flows into the Pacific through a wide tidal estuary, which narrows to a width of three miles at the mouth. Its bed, the shoals, and the bar are composed of a fine sand, easily shifted. Little sediment, however, is brought down by the river. The mean tidal variation at the mouth is 7.4 feet, and the maximum 9.5 feet, the effect at extreme low water being noticeable for 150 miles from the coast. The tidal outflow is estimated as from 1,350,000 as the average to 3,000,000 cubic feet per second as the maximum. The estimated fresh water discharge is from 90,000 to a maximum of 1,500,000 cubic feet per second. The main-channel current on the bar during the ebb runs at all seasons from southwest to west-southwest, with velocities from $2\frac{1}{2}$ to $5\frac{1}{2}$ miles per hour; the flood current runs from north to north-northwest, with velocities from $1\frac{1}{2}$ to $3\frac{1}{2}$ miles per hour. There is a littoral current running at its maximum from 2 to 3 miles per hour with a marked resultant set, due to prevailing influences, towards the north. The sand-drift is therefore northward also, and during the construction of the jetty the sand accumulated on the south side till it overtopped the work. There has been manifest at all times a noticeable tendency for the channel, or channels where two existed, to cross the bar on a southwest course. The depths on the bar varied from 19 to 27 feet.

In the earliest existing chart of the entrance, made in 1792 by Admiral Vancouver, only one channel appears, running almost due west and carrying 27 feet over the bar. The next survey, made in 1839, shows two channels; a southerly one with a bar depth of 27 feet, and a northerly one with a corresponding depth of 19 feet. This condition remained a typical one for more than forty years, the principal changes being the gradual lengthening of Clatsop Spit, and the disappearance of the Middle Sands when the currents tended to reunite into a single channel. During this period the bar depths of the two channels varied between 19 and 27 feet. By 1885, however, the north channel had practically disappeared, since which time the south channel alone has been in existence, although about 1881 a minor channel opened still more to the south, which promised, until checked by the jetty, to create a second main channel.

During the construction of the jetty between 1885 and 1896, the channel swung northward, and in 1895 had a depth of 30 feet over a width of seven-eighths of a mile, and ran almost due west to the bar. This was the best condition attained. The northward trend continued, however, and by 1902 the depth had decreased to 22 feet, the remains of the old channel then pointing to the north, and two new channels of almost equal depth had become apparent. It is worthy of notice that during all the changes between 1885 and 1897 the channel across the bar pointed persistently to the southwest, and that when it swung to the northwest during 1897 and 1898 its deterioration commenced. This change of direction was due to the sand-drift from the south flowing round the end of the jetty, which ended in comparatively shallow water. The evidence shows that this drift is principally due to local movements of the sand, and that there has been no extension of the southwest face of the bar since 1839.

The south jetty, constructed between 1885 and 1896, was intended to secure 30 feet of water in the channel, in which object it was for some time successful. It

¹ This and the next case are quoted from Thomas & Watt, *Improvement of Rivers*.

was later proposed (1905) to obtain a depth of 40 feet with a width of not less than one-half mile. For this purpose the south jetty was to be extended $2\frac{1}{2}$ miles to deep water, and to be raised to mean tide level, and should this fail to secure and maintain the desired channel, a north jetty $2\frac{1}{2}$ miles long or less was to be built. This would locate the outlet on a portion of the bar that had remained practically unchanged since 1839. To expedite the action of the water, suction dredging was commenced and has continued steadily.

The north jetty was not commenced, however, when proposed, and in 1910 further recommendation was made for its construction, with a view to obtaining a deeper and more permanent crossing than the single jetty appeared able to secure. At that time there was a channel over the bar with a width of 8000 feet and a least depth of 24 feet, its center portion having a least depth of $26\frac{1}{2}$ feet with a width of 1000 feet.

Conditions at this outlet are unusually difficult, as the coast is exposed to very heavy seas, and there is a considerable sand-drift working north."

Case of Mississippi River, South Pass. — "The mouth of the Mississippi River, which drains nearly a million and a quarter square miles, is divided into three main outlets — Southwest Pass, South Pass, and Pass-a-l'Outre. As early as 1726 an improvement of the outlet was attempted by harrowing the bottom, and that and other means, such as dredging and partial jetties, were tried for many years with small success. Finally, the construction of a canal at an estimated cost of ten million dollars was recommended, but the project was suspended by the proposal of James B. Eads in 1874 to construct at his own risk the present jetties. After numerous delays this proposal was accepted, and the jetties were built between 1875 and 1879.¹

South Pass is about 12.9 miles long, with an average width of 750 feet, and a least original depth in the channel inside of 29 feet. The original depth on the bar was 8 feet, and the depth on the shoal at the head of the passes, 17 feet. The discharge per second at New Orleans in extreme high water has been given as 1,740,000 cubic feet, and the amount of solid matter carried in suspension at such periods as 2000 cubic feet per second. The range between high and low water there is about $21\frac{1}{2}$ feet; at the head of South Pass it is about $2\frac{1}{2}$ feet. The velocity at the latter point is 5 feet per second, and the fall per mile in the pass, $2\frac{1}{2}$ inches. This outlet before improvement was estimated to have carried about ten per cent of the discharge of the three passes; the remainder was divided almost equally between the other two main passes. In 1910 it carried 11.2 per cent. Its low-water discharge was about 25,000 cubic feet per second, and it carried to the sea about 22,000,000 cubic yards of sediment per annum.

The jetties were built by James B. Eads, who contracted with the United States Government to provide a channel 26 feet deep and not less than 200 feet in width, and with a center depth of 30 feet, and to maintain the same for twenty years for a total cost of eight million dollars. It is stated that this channel was maintained for the twenty years (1879–1899) with the exception of about 500 days. The jetties at the mouth were placed 1000 feet apart, considerably more than the width of the river above, but they were contracted later by inner jetties to a width of 650 feet and by spur dikes to a width of 600 feet. The head of the pass had also

¹ For a history of the improvements, see Annual Report, Chief of Engineers, U. S. Army, 1899, p. 1914.

to be improved by jetties in order to secure a deeper channel and mattress sills were placed across the entrances to Southwest Pass and Pass-a-l'Outre in order to prevent their enlargement and a consequent diversion of part of the flow from South Pass. The conditions here are but slightly affected by the action of storms or sand-drift.

By 1910 there had been secured throughout the channel over the bar a least available depth of 31 feet; this deepening had been obtained almost entirely by scour, although dredging was used to some extent.

The disposition of the sediment by the river is worthy of notice. A comparison of the conditions from 1875 to 1903 indicates that the bar has advanced very little; that the river has maintained a deep channel to the open sea; and that the greater part of the vast amount of sediment brought down in 28 years has been deposited to the east and west of the channel and behind the jetties. The Survey of 1910 shows the same general location of channel across the bar as the survey of 1903. The bank on the south side immediately opposite the ends of the jetties and the somewhat abrupt turn necessitated thereby are a source of some inconvenience to ships descending in any current, and not infrequently they go aground broadside before they can make change of course."

Conditions along coast of United States. — The engineer engaged in harbor improvement along the United States coast line has to consider a variety of conditions. Along the coast from Maine to Cape Cod and to New York along the shore of the mainland, the coast is mostly rock bound, and the bays often represent valleys that were modified by glacial erosion when the land stood higher, but have now become partly submerged by subsequent sinking of the coast line. At the mouth of some of these there are obstructions which consist of rock ledges or glacial detritus. The tidal rise is moderate at Cape Cod, but increases to the northward. The rock is resistant, and hence changes by wave action are not very noticeable.

Improvement in these harbors consists mainly of dredging and rock removal.

From Cape Cod to New York there are a number of island harbors like those of Nantucket, Vineyard Haven, Block Island, and Long Island, all of which are peculiar, and seem to be due to irregularities in the moraine. The tidal rise is only a few feet, but on account of the great interior sounds to be filled, the tidal currents in some places are quite strong. The material of the coast is all unconsolidated. Storms are severe along this part of the coast, and wave effect on the finer materials is often considerable.

The improvement of the harbors is by dredging and by the construction of works for the contraction and protection of the tidal channels.

The shore of the south Atlantic coast or that portion extending from New Jersey to Florida, is composed mostly of fine materials, which

are easily eroded and afford good conditions for the waves and currents. The sea floor extends seaward from 50 to 100 miles, with a uniform slope of 10 feet to the mile. Tidal rise varies from $2\frac{1}{2}$ to 7 feet at different points.

Wave action on the whole is moderate, especially on the southern part of the coast, but nevertheless, the wind waves do considerable work. The harbors are improved by contraction, and protection work and dredging.

Along the Gulf of Mexico, the coast can be divided into two sections. The eastern part is not much exposed to storms, but the on-shore winds of the western portion are strong and continuous. The materials along both sections are easily eroded, and the tidal rise is about one foot. Methods of improvement are similar to those used along the southern Atlantic coast.

Turning to the Pacific coast we find that the materials of the southern part are easily eroded, that the tidal range is large, but that the wind action is small.

On the northern part of the Pacific coast line, material which can be moved by the waves is abundant, but many rocky headlands make the problem somewhat complex. The wave action is tremendous and there are great ocean currents that may have some effect. Tidal action is also strong.

References on Waves and Shore Currents

1. Allanson-Winn, *Trans. Amer. Soc. Civ. Engrs.*, L, p. 66, 1903. (Wave work.)
2. Black, *Trans. Amer. Soc. Civ. Engrs.*, XXIX, p. 223, 1893. (Improvement of South Atlantic coast harbors.)
3. Chamberlin and Salisbury, *Geology*, I, p. 330, 2nd ed., 1905. (Holt & Co.)
4. Cooper, *Trans. Amer. Soc. Civ. Engrs.*, XXXVI, p. 139, 1896. (Ocean and Wave Force.)
5. Fenneman, *Wis. Geol. Surv., Bull.* VIII, 1902. (Theory of wave action.)
6. Geikie, *Textbook of Geology*, 3rd ed., p. 433, 1893, London.
7. Gilbert, *U. S. Geol. Surv., Fifth Ann. Rept.*, p. 80. (Shore line features.)
8. Gulliver, *Proc. Amer. Acad. Arts and Sci.*, XXXIV, p. 151, 1899. (Shore line topography.)
9. Harts, *U. S. A. Corps of Engrs., Prof. Memoirs*, Oct. to Dec., 1911. (Harbor improvement on Pacific Coast.)
10. Haupt, *Trans. Amer. Soc. Civ. Engrs.*, XXIII, p. 123, 1890. (Littoral Movements of the New Jersey Coast.)
- 10a. Johnson, *Shore Processes and Shore line Development*, N. Y., 1919 (Wiley and Sons).
11. Thomas

and Watt, Improvement of Rivers, New York, 1913. (Wiley and Sons.) 12. Sanborn, Trans. Amer. Soc. Civ. Engrs., LXXI, p. 284, 1911. (Theory of the water wave.) 13. Stevenson, Design and Construction of Harbors, 2nd ed., 1874, Edinburgh. 14. Vedel, Trans. Amer. Soc. Civ. Engrs., LIV, Pt. A., p. 139, 1905. (Island harbors and accumulation of material caused by detached works.) 15. Wheeler, Tidal Rivers, 1893. (Longmans, Green & Co., New York.)

CHAPTER IX

LAKES: THEIR ORIGIN AND RELATION TO ENGINEERING WORK

Definition. — A lake may be defined as a body of water occupying a more or less basin-shaped depression in the earth's surface. A small lake is called a pond, and a very large lake is sometimes referred to as an inland sea. These terms are, however, loosely used.

Relation to engineering work. — Engineers in the different branches of their work often have to deal with lakes for the following reasons: (1) Lakes frequently serve as sources of water supply for municipal or steaming purposes, hence their volume, and the chemical composition of the water have to be considered; (2) many navigable lakes of large size show changes of shore lines due to wave action and shore currents, and problems of coast protection and harbor maintenance have to be dealt with as along the sea coast; and (3) by a natural process lakes are often converted into swamps, across which railroad lines have to be laid, these tracts often giving considerable trouble in road-building and maintenance.

TYPES OF LAKES

The formation of lakes is sometimes complex, and their origin may be due to a number of causes; moreover, even after the lake has been formed it is frequently modified in different ways, especially in depth. In North America there are many lakes of varying size and depth, and the table on the following page contains data regarding some of the more important ones.

Lakes may be classified according to origin, and the following grouping has been suggested by Davis: (1) Original consequent lakes; (2) lakes of normal development; and (3) lakes due to accident.

Original Consequent Lakes

This class includes those lakes which occupy original depressions in a land surface. They may be irregularities of the ocean bottom which were preserved when it was lifted above sea-level. The Everglades of Florida occupy such a depression. Other examples of this type are lakes occupying depressions on the surface of lava flows; depressions in

TABLE GIVING DEPTH AND AREA OF A NUMBER OF NORTH AMERICAN LAKES

Name.	Average depth, feet.	Maximum sounded depth, feet.	Area, square miles.	Area of watershed, square miles.
Athabasca, Alta-Sask.			2,842	
Cayuga, N. Y.		435	66 3	1,571 6
Champlain, N. Y.		400	436 7	7,750
Crater, Ore.		1975		
Erie	70	204	10,000	22,700
Geneva, Wis.		142	8 6	
George, N. Y.	60†	170	43 6	227
Great Bear Lake, N. W. Ty.			11,820	
Great Salt Lake	15 to 18	50	2,000 (variable)	
Great Slave Lake, N. W. Ty.			10,719	
Hopatcong, N. J.			2,443*	25 4
Huron	210	702	23,200	31,700
Mendota, Wis.		84	15 2	
Michigan	335	870	20,200	37,700
Mono, Cal.	61	152	87	7,000
Oconomowoc, Wis.		49 2	819*	
Okechobee, Fla.			730†	5,366
Oneida, N. Y.			78	1,352 5
Ontario	300	738	7,260	21,600
Owens, Cal.			75	
Seneca, N. Y.		612	67 2	708 1
Superior	475	1008	31,800	51,600
Tahoe, Cal.		1645	195	324
Winnipegosis			2,086	
Winnipeg		70	9,457	

* Acres.

† When surface stands 20 feet above the Gulf

sand dunes, as on Long Island, N. Y., and depressions in the glacial till (p. 438) or modified glacial drift (p. 439). Lakes of the last two types are not uncommon for example in Wisconsin.¹ Lakes in the drift may be fed by streams, or by springs issuing along the sides of the depression which the lake occupies. Their level may coincide in a general way with that of the water table (p. 308) of the surrounding region, a good example of which is Lake Ronkonkoma on Long Island, N. Y.

Lakes of Normal Development

This class includes all lakes which have been formed in connection with the development of river valleys. Several subtypes deserve notice.

Oxbow lakes. — The formation of these (Plate XL) has been described under Rivers (Chapter V). They are usually shallow, banks low, and shores marshy, and of no particular economic importance.

Beaches across inlets. — The inlet into which a river discharges is to be regarded as the lower extremity of its valley. As explained under Waves and Shore Currents, Chapter VIII, a bar may sometimes form across a harbor (Fig. 182) or inlet mouth, and be gradually built up to a beach, thus more or less completely shutting off any open connection between inlet and sea, so that a lake is formed behind the beach. Even if there remains no open channel between the lake and

¹ Fenneman, Wis. Geol. Survey, Bull. VIII, 1902.

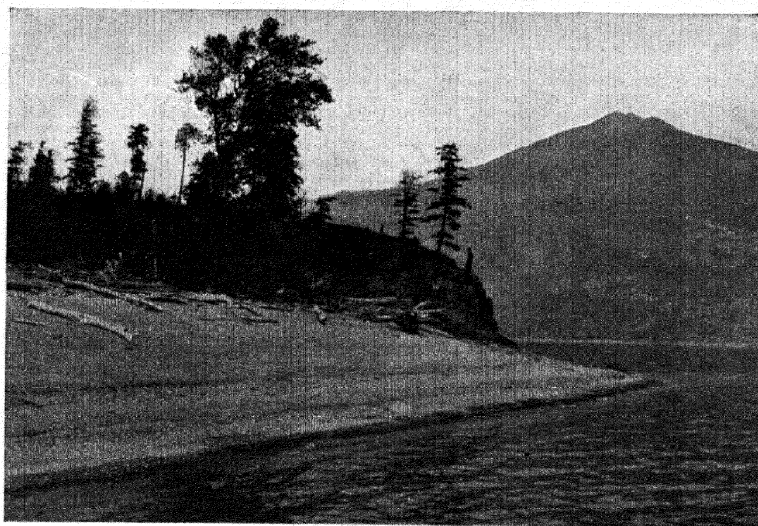

PLATE LVI, FIG. 1. — Gravelly beach formed by wave action, Kootenay Lake, British Columbia. (H. Ries, photo.)

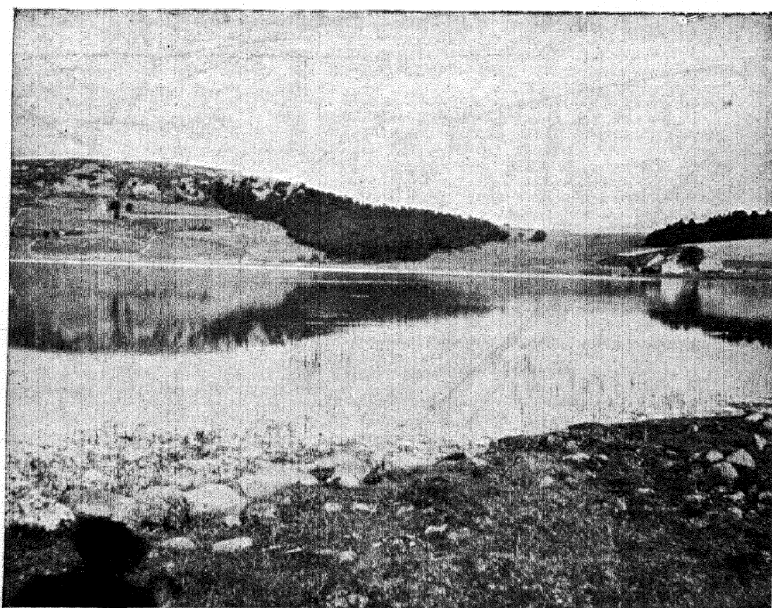

FIG. 2. — Lake formed by barrier of lava, Central France. (H. Ries, photo.)
(413)

the outer water, the water of the lake may still escape by seepage through the sand of the beach ridge. Lakes of this sort are found, for example, along lakes Erie and Ontario, on Long Island, and along the Massachusetts coast (Fig. 182), and may be marshy along their shores.

Sink-hole lakes. — The formation of sink holes in limestone formations is explained in Chapter VI. In some cases these become clogged with débris so that the surface water accumulates in the depression, but the pond is never very large, although in some instances the extended breaking down of the limestone by subterranean solution may afford a depression of some size. In other cases there may be an outflow through one or more sink holes in the bottom of the lake, but the level is not lowered unless the escape exceeds the supply.

Thus in the case of Lake Miccosukee, Florida, which has an area of about 5000 acres (Ref. 6) it was found that when a channel entering from the southwest was discharging about 200 gallons per minute, the lake level was being gradually lowered, but when the same stream was bringing in approximately 7000 gallons per minute the lake was rapidly filling. Sink-hole lakes are rarely large but are sometimes deep.

Crustal movement lakes. — Owing to movements of the earth's crust, depressions capable of holding water are sometimes formed. The simplest case would be a depression formed by warping of the rocks of the earth's crust, either to form a new basin, or else lift up the ends of a pre-existing trough.

Lake Temiskaming in Ontario for example is regarded as a case of the latter.¹ This lake is nearly 70 miles long, its outlet being marked by the Long Sault Rapids. The lake is bounded by rocky shores through much of its length, and is supposed to represent a pre-Glacial canyon which, by the down-warping in its middle part, has become flooded. The total amount of down-warp is estimated at as much as 500 feet in the center of a distance of 50 miles.

Lakes appear to be formed sometimes as the result of faulting, as in the case of the Warner Lakes in Oregon. Here large rectangular blocks of the earth's crust have been tilted by faulting, so that corresponding corners of neighboring blocks have been tilted downward to the same degree. Such lakes are roughly triangular in outline, and bounded on two sides by cliffs, along which the water may be deepest, and shoals off towards the third side.

Lakes Due to Accident

This class includes those lakes located along lines of drainage which have become dammed from one cause or another. They are of variable size and differ in their degree of permanency, some being but short-lived.

¹ Pirsson, Amer. Jour. Sci., 4th series, XXX, p. 25, 1910.

Drift-dam lakes. — In many cases where a river valley was formed prior to the Glacial period, a dam of glacial drift was deposited across the stream's course at some point, which served to impound the river waters. Lake George in New York State is a lake of this type. The valley above the dam may be in part filled with drift. The tightness of the drift dam will depend on whether it is dense till or gravelly and sandy modified drift.

This is probably the most extensive type of glacial lake. Plate LVIII, Fig. 2, shows a lake that is held up in a valley by a terminal moraine (p. 438).

The bottom of a lake originating in the manner described above, may be the original rock floor of the valley, but is more likely to be formed of the glacial drift which partly fills the pre-Glacial valley.

In some cases a lake may form behind the terminal moraine of an existing glacier, being held in on one side possibly by the ice itself (Plate LVII, Fig. 1). Small lakes of this sort are not uncommon in regions of existing glaciers.

Lake Como, in the Bitter Root Valley, Montana, is described as a deep natural lake basin formed by a terminal moraine of fine and coarse gravel, sand, and rock flour. The Twin Lakes, near Leadville, Colo., are said to be located between two great lateral moraines, and held in by a terminal moraine, which consists chiefly of rock flour and is practically impervious to water.¹

Landslide lakes. — The name of this type explains the manner of origin, for wherever a landslide of more or less water-tight material crosses a valley occupied by a stream, a lake is likely to be formed. Lakes of this type are rarely of great extent. The dam that holds them in may occasionally be of considerable width, and contain much stony material, so that it involves time and trouble to cut a drainage channel across it. The landslides causing an obstruction of the stream may either be material dislodged from the valley slopes, or soft unconsolidated material that has been undermined by the stream. The last type is not effective except in the case of small streams and even then the slide may only obstruct the river temporarily.²

Schuyler³ describes "a natural dam on a branch of the Umpqua river in Oregon, over 300 feet high, formed by a landslide from the adjacent sandstone cliff. The base of this dam is not over 3000 to 4000 feet. Floods of several thousand second-feet pass over the top of it every year, and it is practically water-tight, as it holds back a good-sized lake. This is a natural rock-fill dam composed of enormous blocks of stone, whose voids are filled with smaller stone and rock dust ground up in the process of falling." Crystal Lake in Colorado is a lake of the landslide type.

Lava dams. — In some regions of volcanic activity, a lava flow occasionally obstructs a valley, so that the water becomes ponded behind it. No large water

¹ Schuyler, Reservoirs, pp. 483 and 487, 1908.

² See G. M. Dawson, Geol. Soc. Amer., Bull. X, p. 484, 1899.

³ Schuyler, Reservoirs, p. 483, 1908.

bodies of this type are known. Plate LVI, Fig. 2, shows such a lake in south central France. Snag Lake in California is also of this type.

Crater lakes. — The craters of many extinct volcanoes are often more or less filled with water, but so far as known they have never been used for economic purposes. Indeed they are not very abundant. Plate LVII, Fig. 2, shows a crater lake in the volcano of Toluca, Mex., 14,000 feet altitude. Crater Lake, Oregon, which has a diameter of about six miles is one of the largest known. In some regions of present volcanic activity, there may be bubbling in the lake due to escape of steam or other gas.¹ Crater lakes must perforce have a small drainage basin and can hardly be drawn upon as a source of water supply for any purpose.

Glacial dams. — The advance of a glacier across a river valley may dam the flow sufficiently to form a lake. In regions of alpine glaciers they are seldom of large size, and are not to be considered except for threatened danger from floods in the event of their sudden release.

In Alaska, however, a region which will attract the engineer's attention to an increasing degree in the future, the effects of living glaciers on drainage obstruction may have to be occasionally reckoned with. Thus, the constriction of the Copper River by Child's glacier gave rise to the lake in which Miles glacier terminates. The lake was crossed by a car ferry until the bridges on the Copper River railroad had been completed.²

LAKE WATERS

Waves and Currents

Wave and ice action. — Wherever a lake is of sufficient size to permit waves and shore currents of any importance to develop, and the coast line is composed of soft materials, we find the same erosion and deposition going on as along the ocean coast line. These phenomena are described in Chapter VIII, and need not therefore be repeated here.

A phenomenon seen in some lakes, not observed in the ocean, is the development of *ice ramparts*. In many lakes the water becomes entirely covered by ice during cold weather. If the ice covering has a temperature of say 20° F., and the temperature is lowered to say -10° F., the ice contracts, which results in its either pulling away from the shore, or cracking. If the former the water uncovered at once freezes; if the latter the water filling the cracks does the same.

When the temperature rises again, the ice expands, and either crowds up against the shore or arches up at some other point. Where the shore is gravelly or composed of other soft material, it is sometimes

¹ Hovey, Nat. Geog. Mag., 1902.

² Martin, Bull. Amer. Geog. Soc., XLV, p. 801, 1913.

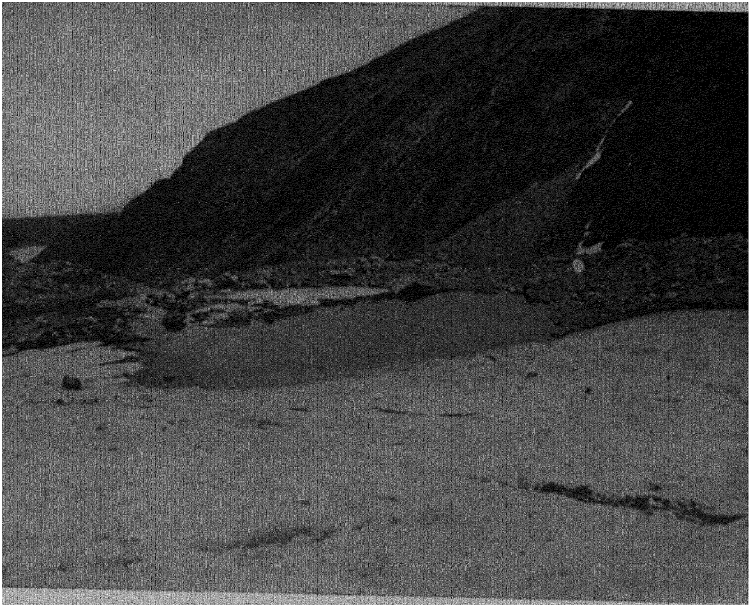

PLATE LVII, FIG. 1. — Lakelet held in by terminal moraine and glacier. (R. D. George, photo.)



FIG. 2. — Crater lake, volcano of Toluca, Mexico. (H. Ries, photo.)

pushed up into ridges. These often differ from beaches or bars in that the material may be entirely unsorted.

Such ice terraces were noted by Buckley, and have since been described by Fenneman for many of the Wisconsin lakes.¹ Where structures occur along the shores of the lake considerable damage may be caused by the ice thrust.

Lake currents. — Currents of either temporary or permanent nature may be present in many lakes, but in most cases they are so weak as to attract little attention. These currents may be: (1) The general movement of the water from inlet to outlet of lake, the *body current*, whose speed is slow; (2) a surface current due to prevailing winds; (3) return currents; and (4) surf motion, which produces a general drift towards the shore, and in some cases a shore current if the waves approach the shore line obliquely.

The first of these may be noticeable only at the head and foot of the lake, but is not necessarily a direct flow from head to foot. The second will be in the direction of the prevailing wind. The third will depend to a large degree upon the capacity of the outlet, whether it can take care of all the water that is driven toward it.

Some years ago the U. S. Weather Bureau² attempted to ascertain the direction of currents in the Great Lakes. It was found that in Lake Superior the return current was along the southern shore; in Lake Michigan along the eastern shore; in Lake Huron along the western shore; but in Lakes Erie and Ontario it was not so clear.

Variations in lake level. — The surface level of all lakes is liable to fluctuations, which may be gradual or sudden.

Gradual variations. — These can usually be correlated with rainfall. During a rainy season, a lake with outlet may be supplied with water by surface streams and springs faster than the outlet can carry it off, and the level of the lake rises, it may be only a few inches, or it may be several feet. Such variations are not confined to small lakes, but are sometimes quite noticeable in large ones.

It is said, for example, that "since the settlement of the Great Lakes region the level of lakes Michigan and Huron has fluctuated noticeably. Not only is there a regular seasonal fluctuation of about one and one-half feet (high water coming in June or July, and low water in mid-winter), but there are greater changes through periods of several years. In 1886 Lake Michigan was about two feet higher and in 1896 nearly three feet lower than in 1906. At high water in 1838, the same lake

¹ Wis. Geol. Survey, Bull. VIII.

² Bull. B, 1894.

stood nearly six feet higher than at low water in 1896. When these secular changes of level are plotted next to a rainfall curve¹ the connection between periods of unusual rainfall or drought and periods of high or low water is evident."²

Sudden variations. — Lake waters are sensitive to changes of atmospheric pressure. It is sometimes noticed that in calm weather the lake level may show a variation of several feet in less than an hour. Such oscillations are known as *seiches*.³ Of course on small lakes the *seiche* is smaller than on large ones and in many is hardly appreciable. In addition to these, rhythmical pulsations producing a difference in level of as much as four or five inches during calms, unaccompanied by variations in atmospheric pressure, have been observed, but these are little understood (Russell).

Effect of strong wind. — If a strong wind blows over a lake surface for some time in one direction, the water is forced toward one end, resulting in a marked difference in level at the two extremities of the lake. In the case of Lake Erie, this difference may sometimes amount to as much as 15 feet.

Temperature of lakes. — Lake waters may be warmed, either by the sun's heat, or by contact with the air, but since water is a poor radiator as well as a poor conductor of heat, it will not respond to atmospheric temperature changes as readily as solid mineral masses like rocks. A shallow lake may be warmed to the bottom by the summer's heat, and equally chilled by the winter's cold, although its temperature will be more uniform than that of the air.

The subject of the temperature of ponds and lakes is of considerable practical importance, where these are to be used for water supply, since it is desirable to obtain water not only of good quality, but sometimes at a uniform temperature.

Engineers connected with waterworks should be familiar with the seasonable changes of temperature in lakes and reservoirs used for water supply. This is especially true of deep ponds (say those deeper than 50 feet), because in these the temperature changes may produce or prevent vertical currents at different seasons, which often exert an important influence on the quality of the water at different depths.

If in a given lake a series of temperature determinations be made at different depths throughout the year, it will be found that the shallower layers of water show the greatest variation, warming in summer and

¹ Lane, A. C., Mich. Geol. Survey, VII, Plate V.

² Atwood and Goldthwait, Ill. Geol. Survey, Bull. 7, p. 68, 1908.

³ Perkins, American Meteorological Journal, Oct., 1893.

cooling in winter, while at greater depths, beginning even as low as 50 feet, the change from season to season is comparatively slight.

Even during warm summer weather, the deeper layers of a fresh-water lake may be quite cool. This is due to the fact that water is densest at 39.2° F., and the water which becomes cooled in winter sinks to the bottom. Moreover, water is a poor conductor of heat, hence the cold lower layers are not warmed in summer. This difference in weight of water at several temperatures above and below its point of maximum density is shown by the following figures.

Temperature of water.	Density.
Degrees F.	
32	0 99987
39 2	1.00000
50	0 99974
70	0 99800
86	0 99577

The changes taking place in Lake Cochituate in Massachusetts have been well described as an example of those occurring in any lake of moderate or good depth which freezes over in winter.¹ The temperature curves given in Fig. 187 are considered to represent approximately those of bodies of water with depths varying from 20 to 80 feet, and exposed to the same climatic conditions as those prevailing in the vicinity of Boston. It is seen there (consult Fig. 187), that from the time of the breaking up of the ice in March, the surface warms considerably more than the mid-depths and bottom, and that after September the surface temperature drops rapidly.

With regard to the bottom temperatures, Fitzgerald states that if a pond is less than about 25 feet deep, the bottom temperature does not differ much from the surface, although in winter it may be 5° or 6° warmer, and in summer as many degrees cooler. Such shallow ponds are stirred to their depths by winds, which help to keep the temperature equalized.

In deeper lakes, however, like Lake Cochituate, when the surface freezes over about January first, the bottom temperature is near 39.2°; or it may be much below this if the weather has been severe and the winds high prior to freezing over. The several layers in the lake will of course lie in the order of their density, the temperature increasing gradually upwards, until within a few feet of the surface, when it suddenly falls to the freezing point. The water will remain so until the ice breaks up. The warming up of the surface about April first to about the same temperature as the bottom causes a state of unstable equilibrium, and circulation begins from top to bottom. This is spoken of as the *working* or *overturning* of the lake waters.

When by May first, as in Lake Cochituate, the surface temperature exceeds the bottom by about 5°, the difference in density seems to be sufficient to prevent further warming up of the bottom layers. There follows then a period of *stagnation* which lasts until about the middle of November, when a second and stronger period of circulation begins which lasts until the lake freezes.

During the summer stagnation, the winds may not stir the lake much deeper than 15 feet, although this depends on the difference of density of the several layers.

¹ Fitzgerald, Trans. Amer. Soc. Civ. Eng., XXXIV, p. 67, 1895.

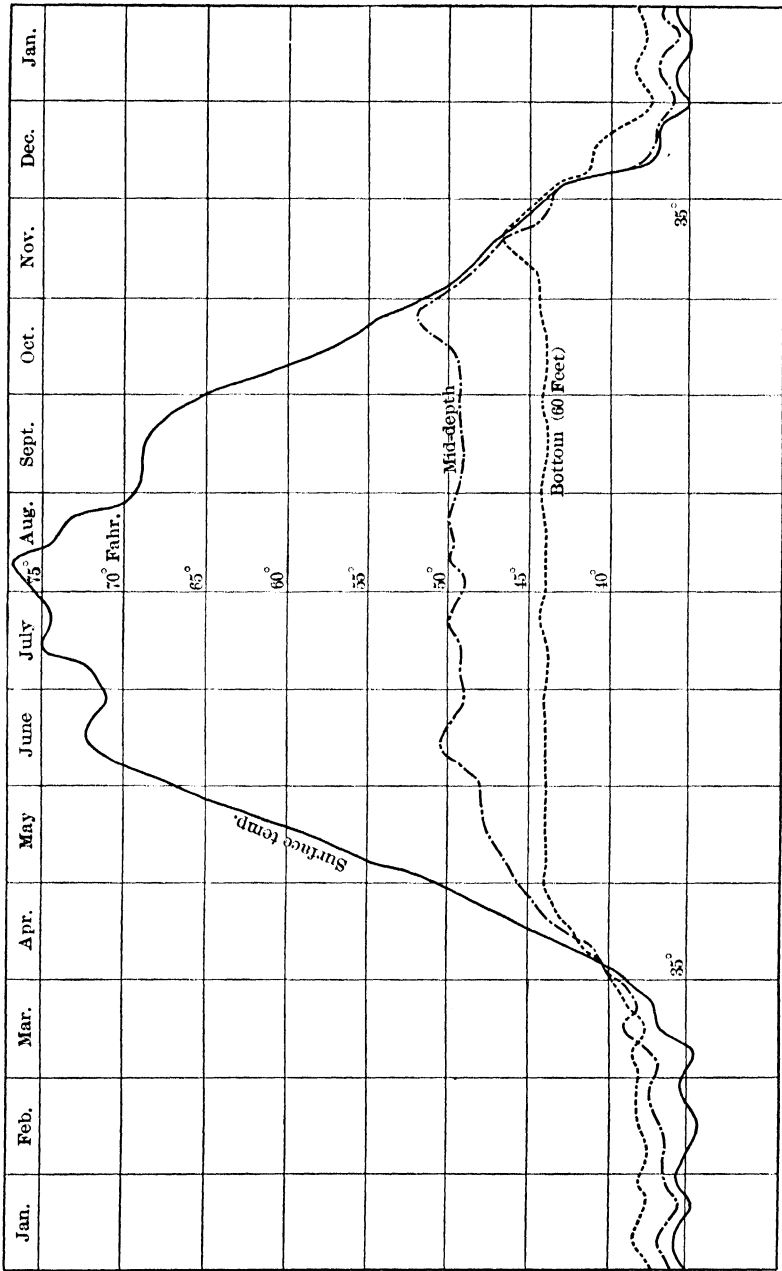

FIG. 187. — Temperature curves during twelve months of year, in Lake Cochituate, Mass. (Fitzgerald, Trans. Amer. Soc. Civ. Eng., XXXIV.)

The effects of stagnation are of importance in relation to municipal water supplies. During stagnation, if there is much organic matter in the lake, it collects in the lower quiet layers, and decay continues until all the oxygen is used up. The water gets darker, and has a bad odor. Free ammonia and other decomposition products accumulate. With the overturning of the lake in autumn this decayed matter is brought to the surface.

The phenomena just referred to may be lacking in: (1) A lake that is free from organic matter; (2) one so large that the organic matter brought in by feeding streams is completely oxidized; and (3) in a large artificial reservoir constructed on sanitary principles. It is however at the surface, at the end of summer.

In deep lakes covered with ice in winter, there are two lines or curves of profile which confine the variations of temperature within certain limits — the winter curve and the summer curve. These curves very nearly meet at the bottom if it is a deep lake, and are separated by a considerable interval as the lake becomes more shallow. Recognition of the phenomena described above will enable the water-works engineer to locate the off-take pipes so as to obtain water with regard to uniformity of temperature and purity. In artificial reservoirs of depth a low off-take may be provided for drawing off the impure water.

Lake Thun, Switzerland. — Recent data on the temperature of deep lakes seem to be lacking, but the following table¹ gives a valuable series of determinations made by Fischer-Ooster and Brunner in Lake Thun in 1848–1849. This table shows the diminution in temperature throughout the mass in winter, and the heating of the lower strata long after the surface had begun to cool off. It is seen that the maximum temperature at depths of 10 to 80 feet occurs in September; at 80 to 120 feet in October; and at 120 to 350 feet in November.

TEMPERATURES AT DIFFERENT DEPTHS IN LAKE THUN

English feet.	Mar. 28, 1848.	May 13	July 3.	Aug. 5.	Sept. 6.	Oct. 28.	Nov. 26.	Feb. 3, 1849.
Surface	42 3	59 1	59 6	62 8	65 6	53 4	46 3	40 8
10 7	41 4	51 4	59 0	60 4	61 8	53 2	46 3	41 0
21 3	41 3	49 2	57 2	57 3	59 1	53 0	46 4	41 2
32 0	41 2	48 0	53 2	55 5	57 7	53 0	46 2	41 0
42 6	41 1	46 6	52 1	54 4	56 2	53 2	46 1	40 7
63 9	40 9	44 8	49 6	52 6	53 8	53 0	46 1	40 7
85 3	40 8	44 2	46 3	50 7	50 9	52 1	46 1	40 7
127 9	40 4	41 8	42 3	43 7	43 4	43 6	44 0	40 7
170 5	40 4	41 5	41 4	41 8	41 7	42 1	42 1	41 0
266 5	40 4	40 8	41 0	41 1	41 4	41 0	41 3	40 7
373 0	40 6	40 9	40 9	41 1	41 1	40 8	40 7	40 6
479 6	40 7	40 7	40 8	40 9	40 8	40 9	40 6	40 7
586 3	40 7	40 7	40 8	40 7	40 8			

¹ Abstracted in Fitzgerald's paper referred to above.

Composition of Lake Waters

The waters of lakes may show a wide range in composition. Those of fresh-water lakes, that is, those having an outlet, do not differ so much from river waters, although of course a lake receiving tributaries that have flowed over different formations might show a composition expressing more or less the average of these. It is in the inland lakes, without outlet, and which often show high salinity (p. 288), that the most marked variation in composition is found. The waters of the fresh-water lakes often run high in carbonates.

In the table given on page 424 will be found the analyses of a number of lake waters of which 1 to 8, and 10 are from fresh-water lakes; the others are from more or less strongly saline ones.

These saline ones are representative of the following types: (1) Chloride type, solid matter mostly sodium chloride, as in Great Salt Lake, No. 9; (2) carbonate or alkaline type, in which sodium carbonate is largely in excess, as in Goodenough Lake, No. 16; (3) carbonates and chlorides predominating, with sulphates subordinate, as in Pyramid Lake, No. 11; (4) "triple" type, with chlorides, sulphates, and carbonates all present in notable amounts, as in Owens Lake, No. 14, Mono Lake, No. 13, and Tulare Lake, No. 17; (5) sulphate-chloride type, as Devil's Lake, No. 15.

Type No. 2 exhibits the nearest relationship to river waters.

OBLITERATION OF LAKES

Lakes may be naturally obliterated in several ways: (1) By evaporation; (2) by cutting down of outlet; (3) by filling of the basin with sediment, plant growth, or both; (4) by lowering of surrounding ground-water level; and (5) by a combination of several of these.

Obliteration by evaporation.— In many arid regions, there are a few lakes which have no outlet, and whose waters escape chiefly by evaporation. These lakes are all of saline character. In some instances lakes of large area and great depth have almost completely disappeared in this manner, only small remnants being now left. One of these, Lake Lahontan,¹ which covered parts of Nevada, had an area of 8400 square miles; another one, Lake Bonneville,² of which Great Salt Lake is a remnant, had an area of 17,000 square miles, and a depth of about 1000 feet.

Some lakes without outlet, found in arid regions, belong to the

¹ Russell, U. S. Geol. Survey, Mon. XI.

² Gilbert, U. S. Geol. Survey, Mon. I.

ANALYSES OF LAKE WATERS

	1	2	3	4	5	6	7	8	9	10	11	12	13	14	15	16	17
CO ₂	47.42	49.45	47.26	44.70	45.81	26.83	32.81	20.93		38.73	14.28	17.84	23.42	24.55	4.24	41.41	19.55
SO ₄	3.62	6.15	5.77	9.83	11.03	14.46		7.12	6.82	7.47	5.25	21.29	12.86	9.93	54.07	7.08	20.77
Cl	1.89	2.31	2.42	6.58	1.78	13.83	0.72	7.96	55.69	3.18	41.04	23.77	23.34	24.82	10.45	7.64	20.26
NO ₃	0.86	0.26	0.38	0.23										0.45			
Ca	22.42	22.21	22.33	23.45	21.19	14.94	25.52	7.29	1.05	12.86	0.25	0.90	0.04	0.02	Tr.	0.02	0.28
Mg	5.35	7.01	6.52	5.75	4.21	1.80	7.23	0.25	2.10	4.15	2.25	1.56	0.10	0.01	3.36	0.04	0.26
Na	5.52	4.02	4.10	4.92	6.80	12.79	1.63	13.22	32.92	10.10	33.84	34.83	37.93	38.09	25.88	36.17	35.79
K						4.29	2.32	3.99	1.70	4.56	2.11		1.85	1.62		6.65	2.44
SiO ₂	12.76	8.54	11.16	4.46	5.58	9.68	4.37	35.51		18.95	0.95	0.31	0.14	0.14	Tr.	.04	.65
Fe ₂ O ₃	0.16	0.05	0.06	0.06		1.60	1.38	3.39	0.1				Tr.				
Al ₂ O ₃													Tr.				
NH ₄													Tr.				
B ₂ O ₃																	
PO ₄																	
Salinity parts per million	0.60	118	108	133	67	14.5	110	118	23.04	73	3.486	2.500	51,170	213.7	11,278	103,470	4,910

1. Lake Superior at Sault Ste. Marie. Mean of 11 analyses taken between Sept. 22, 1906 and Aug. 22, 1907; 2. Lake Michigan at St. Ignace. Mean of 11 samples taken between Sept. 20, 1906, and Aug. 30, 1907; 3. Lake Huron at Port Huron. Mean of 9 samples taken between Sept. 21, 1906 and June 21, 1907; 4. Lake Erie at Buffalo, N. Y. Mean of 11 samples taken between Sept. 19, 1906 and Aug. 28, 1907; 5. Lake Champlain, N. Y. Average of 5 samples taken in the broad lake; 6. Moosehead Lake, Me.; 7. Lake Minnesota, Minn.; 8. Yellowstone Lake, Mont.; 9. Great Salt Lake, Utah; 10. Lake Tahoe, Cal.; 11. Pyramid Lake, Nev. Average of 4 analyses; 12. Walker Lake, Nev.; 13. Mono Lake, Cal.; 14. Owens Lake, Cal.; 15. Devil's Lake, N. Dak.; 16. Good-enough Lake, 28 miles north of Clinton, B. C.; 17. Tulare Lake. Has outlet only during floods. All taken from Clarke, U. S. Geol. Survey, Bull. 491, 1911.

periodic type, that is to say, they evaporate to dryness during a portion of the year, or sometimes for a longer period. Such lakes are also known as *playas*, and are common in the arid region of the western states.

As a rule lakes with no outlet occur in sparsely inhabited regions where they cause little trouble, but when it is necessary to drain them, it sometimes involves considerable work.

An interesting case of this was the draining of Texcoco and other lakes in the valley of Mexico City. Here there is a group of lakes which have no outlet, but receive the drainage from the surrounding hills. During the rainy season the lake level rose to such an extent as to flood much of the surrounding country, and even affected Mexico City. The drainage system, which was built to carry off not only the surplus waters of the lakes but also the sewerage of Mexico City, involved the construction of a canal about $47\frac{1}{2}$ kilometers long, and a tunnel about 10 kilometers in length, from which the water drained into the Gulf of Mexico.

Cutting down of outlet. — Where a lake is held in by a rock barrier, the escaping water flowing over this will perform little erosion, for the reason that the lake acts as a settling basin, and so the water becomes drained of much of its suspended load in passing through it. The clear water flowing off at the lower end cuts but slowly.

If the barrier which impounds the waters of the lake is of unconsolidated material, erosion will proceed more rapidly, but not with startling rapidity. In the latter case, however, an artificial outlet could be cut more readily than in the former.

Obliteration by filling. — This is a more frequent cause of obliteration, which can be noticed in progress in many localities, but which does not become effective in a comparatively short period of time unless the lake is small and shallow. It may be due to two causes: (1) Sedimentation, and (2) plant growth.

Many streams flowing into lakes carry considerable sediment. This, of course, is dropped at the mouth of the stream, forming a delta which gradually extends out into the lake (Plate LVIII, Fig. 2). At the same time the finer sediment is spread out over the lake bottom. A small lake or artificial reservoir may thus sometimes become silted up to a noticeable degree in a comparatively short time; indeed the process is to be seen under way in dozens of lakes.

At the head of some lakes delta deposits have encroached some distance and are of considerable thickness. Thus at the head of Cayuga Lake, N. Y., they are over 400 feet thick.¹ At the head of Seneca Lake

¹ Part of this is glacial drift.

the end has been advanced northward some two miles by deposition, and the filling is over 1000 feet thick. Kootenay Lake in British Columbia has been filled in for a distance of several miles at its head or southern end with the sediments deposited by the Kootenay River. The delta built by the Rhone into Lake Geneva is several miles in length, and has been lengthened nearly two miles since the time of the Roman occupation (Chamberlin and Salisbury).

Another less important process of lake filling is by the accumulation of bog lime on the lake bottom, but this is slow, and to be looked for only in regions of calcareous waters, such as occur in some of the northern central states. The deposits thus accumulated sometimes underlie several hundred acres to a depth of 10 or 20 feet, and are often of sufficient purity to be of commercial value.

Filling by plant growth is a widespread and sometimes important process. Around the edge of many ponds there is a growth of water-loving plants, which gradually extend out toward the middle of the lake as the water becomes shoaled by the deposition of sediment.

By a combination of these two processes the pond may be gradually converted into a swamp. Many swamps and bogs are the last stage in lake obliteration. Consequently in section they often show an upper series of layers of muck or peaty material, and a lower series of sand and mud, or sometimes bog lime, the whole more or less softened by water.

Obliteration by lowering of groundwater level. — As noted elsewhere, the lake surface may coincide with the groundwater level. Any cause which tends to permanently depress the level will operate to destroy the lake. In some cases the opening of land for agriculture, with the clearing off of forests and consequent increased run-off, may be an active cause. This lowering of the water level will be most noticeable in porous, gravelly, or sandy formations.

A case in point is seen in southeastern Portage County, Wis.¹ There "in the broad level areas of alluvial plains bordering the Green Bay Moraine in this part of the area, the level of the groundwater has been lowered to depths varying from a few feet up to 40 feet since the region was opened to agriculture. It is a noteworthy fact also that in this area, where the groundwater has been appreciably lowered, the lakes have become greatly contracted and many of them are entirely extinct. Most, if not all, of these contracted lakes, long ago lost their outlets and their bottoms do not contain an appreciable amount of filling due to wash or to organic agencies. The natural inference is, therefore, that these lakes are being destroyed by the same causes which have operated to lower the level of the groundwater of the area. In those parts of the area where the underlying formation con-

¹ Weidman, Wis. Geol. and Nat. Hist. Surv., Bull. XVI, p. 613, 1907.

sists of an abundance of clay or other impervious rock, where little change in the level of the groundwater has been wrought by cultivation, this process of lake extinction is relatively unimportant."

Extinct Lakes. — We find records in many parts of the country of pre-existing lakes, some of them of vast size. In some cases they occupied natural basins of the earth's crust, but in other instances were evidently due to obstruction of the surface drainage by the ice sheet which once covered the northern states, and remained as long as the cause did.

The former existence of these lakes is recognized in various ways. Sometimes we find a natural basin partly filled with lake sediments, forming an extensive flat, with characteristic fossils present in the beds.

In other cases the former existence of the lake is recognized by old shorelines formed by wind, stream, and wave action. Not only these forms of shorelines are shown but there may also be preserved spits, hooks, bars, deltas, and beaches as in the ancient Lake Bonneville, the ancestor of the present Great Salt Lake, in Utah.

The waters of the Great Lakes formerly covered a much larger area than they do now as their outlets were closed up by the continental ice sheet. Their old shore lines sometimes serve as natural grades for roads, the well-known Ridge road along Lake Ontario being one.

Swamps

General characters. — A swamp may be defined as any area where the ground is saturated with water during most of the year, and the land not deeply submerged. Some swamps are called *marshes*, *bogs*, *muskegs*, and *tundras*. Swamps occur in different topographic positions, but a majority of them are nearly or quite level, although they sometimes occur on the slopes of hills and mountains. They are frequently associated with lakes, seas, and rivers, and every gradation may be found between lakes and swamps on the one hand, and between swamps and uplands on the other.

Swamps may result from poor drainage, impeded percolation, or checked evaporation of the surface water. A level land surface may prevent thorough drainage, impervious soil or rock may retard percolation, and dense vegetation may check evaporation. In any region where the excess surface water is not disposed of by the above processes, the ground is liable to become swampy and may remain so for an indefinite time. Swamps may be *permanent* or *intermittent*.

Kinds of swamps. — Swamps may be divided into two groups (Ref. 11): (1) *Inland* or *fresh-water* swamps, and (2) *coastal* or *salt-water* swamps. Under coastal swamps are included those exposed to the influence of salt water, while under inland swamps are included those not so exposed.

Inland or fresh-water swamps. — There are several classes of these which differ in many ways including origin and development. The more important ones, together with their characters, are as follows:

Lake swamps. — These are formed by the partial or complete filling of a lake, chiefly by vegetable matter (p. 426). The process of filling is discussed on page 425. The swamps may be due either to the complete filling of a lake by plant growth, or to the development of a floating mat of vegetation on the surface of the lake. The mat may often be several feet in thickness, and some mats as much as 70 feet thick are known. Railroads and wagon roads laid on the mats have sometimes broken through them (p. 430).

River swamps. — Such swamps are always associated with rivers, and are usually formed on flood plains and deltas, where they may be due to frequent overflow as well as to levelness of the surface. The following subtypes of river swamps are recognized: (1) *Oxbow* swamps, which, as the name indicates, develop by the filling in of oxbow lakes; (2) *backwater* swamps, which occupy depressed portions of a river's flood plain, and are separated from the river by natural levees, the water remaining in the depressions where, by the growth of plants, swampy conditions develop; (3) *delta-plain* swamps, which are like (2), except that they are developed on deltas; and (4) *estuarine* swamps formed near the outlet of a river on a flood plain where the water is backed up by the tide. River swamps are abundantly developed along the lower Mississippi.

Spring swamps. — These are developed on flat, usually sloping areas where spring water seeps out along some impervious formation. The areas may be wet for the whole or a part of each year. The swamps may have a thin covering of peat and are often difficult to traverse.

Flatland swamps. — These occur on flat poorly-drained lands, such as are characteristic of parts of the Atlantic Coastal Plain from New Jersey southward. They are permanent in many areas and intermittent in others. The great Dismal Swamp of Virginia and North Carolina, which covers 2000 square miles, and the Everglades of Florida, covering 4000 square miles, belong to this class. Peat beds of commercial value may be developed in some of the larger swamps, as in the Dismal Swamp of Virginia and North Carolina.

Raised bogs. — This type includes swamps formed on elevated flatlands in regions of high precipitation, high humidity, and cool summers. They are often filled with growths of *sphagnum* or *bog moss*, and may be higher in the middle than around the edges, hence the name *raised bogs*. Such bogs are common in eastern Maine, Nova Scotia, Newfoundland, and the far north. The *tundra* of northern latitudes owes its swampy character to the melting during summer of the upper foot or two of the frozen soil, the latter being frozen in places to a depth of several hundred feet. Such swamps are very difficult to traverse on foot.

Coastal or salt-water swamps. — Swamps of this type are commonly formed between low- and high-tide levels, and are exemplified by the *salt marshes* along most of the Atlantic and Gulf coasts and by the *Mangrove Swamps* of southern Florida. They may be developed along a coast where protected from excessive wave action or may extend along the shores of tidal estuaries. They represent a common type along the Atlantic Coastal Plain, and are often of vast extent.

Swamps and engineering work. — Swampy tracts give the engineer much trouble, because the soft nature of the ground makes them difficult to cross with either wagon roads or railroads. In the Atlantic and Gulf Coastal plains, as well as in some of the northern states and other countries, railroads often have to cross such tracts for long distances.

If the deposit of plant material in such a swamp is thick, it is often difficult to get solid ground for fills or other material on which to lay tracks or ballast. Where, however, the plant growth is thin, a solid foundation of silt may be found beneath it. Swamps should, therefore, be carefully examined before a line of travel is constructed across them. Many an engineer who has tried to construct an embankment across them has seen his "fill" slowly sink, while the ground has risen, sometimes in waves, on either side.

In some instances the road has sunk out of sight over night. In other cases load after load has been added to the road bed, without appreciably raising its level, until it was discovered that the underlying material was quietly flowing out laterally, in one instance, to a lake a quarter of a mile away. Several cases may be cited.

A case which is typical¹ of many occurred along the line of the Panama Railroad where it was necessary to make a 90-foot fill. A 30-foot trestle was built and filled without any trouble. A second 30 feet was added and stood. It was then raised to 85 feet, and the next morning was out of sight, leaving a 90-foot lake, 400 or 500 feet long. Two more trestles

¹ Slifer, W., Soc. Eng., XVIII, p. 609, 1913.

were lost and then the engineers began loading up the outer edge of the soft area to counterbalance the fill.

Another interesting case is that of a railroad built across the Appalachicola River in Florida in 1907. A trestle five miles long was needed, four-fifths of which ran through densely wooded swamps, and the rest across open marsh. The mud in places was so soft and deep that a firm bottom was not reached by spliced piles 170 feet deep. In such places piles of ordinary length, closely spaced, worked for a time, but in 1918 earth was being hauled some distance to fill in the trestle.¹

One more phase of the matter should be mentioned. In some cases of lake filling, encroaching vegetable growth forms a floating mat (Fig. 203) which eventually completely covers the pond and becomes so thick and solid as to support tree growth, even though there be clear water underneath. These mats are sometimes mistaken for solid ground.

Such bogs have given much trouble along the lines of the Pere Marquette, Ann Arbor, Michigan Central, Grand Trunk and other railroads, in Michigan. Many are known to occur in Minnesota and are crossed by railroads.

An interesting case occurred along the line of the Grand Trunk Railway at Haslett Park. According to Davis,² "The road was originally built with a single track, and a large amount of timber was used to form a foundation for the road bed, which was built above it. Little difficulty was experienced from instability of the stratum until 1902, when the track was doubled. In the process of this work the dirt, which was dumped by the side of the existing embankment, gradually sank out of sight, leaving a pond of water, at the same time forcing the track and right-of-way fences out of line. The weight of the material for widening the old embankment broke the mat, and carried down with it a portion of the old filling as well as the peat below it, so that the track sank whenever trains passed, sometimes a half foot, and this would have to be raised by filling before the track could be used again. In filling the opening permanently about 30,000 cubic yards of material were used before the track stopped sinking. The greatest depth of the hole under the mat was 28 feet. In another larger bog, on the line of the same railway, and less than 6 miles from the one described, there were used more than 60,000 cubic yards of filling in making the changes from single to double track. This depression was 55 feet deep."

In northern latitudes like parts of Alaska, northern Russia, etc., the conditions are different and are well described in the following paragraph (Ref. 11):

"In arctic and subarctic regions, such as large parts of the plains of Alaska and of northern Russia, seasonal changes in temperature produce intermittent swamps,

¹ See also Fla. Geol. Surv., 3rd Ann. Rept., p. 235.

² Mich. Geol. Surv., Rept. for 1906, p. 155, 1907; also Waterbury, The Michigan Engineer, 1903, p. 38.

because the soil and unconsolidated material are in places frozen to a depth of several hundred feet. The lower part of this material does not thaw, but the upper foot or two melts during the summer, and as there is no underground drainage the water does not run off but forms swamps that are extremely difficult to traverse on foot, as the traveler sinks knee-deep into mud. These swamps cannot be drained by clearing away the overburden or digging ditches, for such work only exposes fresh surfaces to melting and forms chasms. Railroads can be best built in country of this kind by disturbing the surface vegetation as little as possible and building on it mattresses of bushes on which to lay the ties and tracks. Although fatiguing to traverse, these swamps can be crossed without danger, for a solidly frozen mass lies a short distance below the surface. During the winter, of course, the entire zone that is melted in the preceding summer is frozen again."

References on Lakes

1. Davis, C. A., Mich. Geol. Survey, Ann. Rept., 1906, p. 105, 1907. (Peat bogs.)
2. Fairchild, H. L., Geol. Soc. Amer., Bull., Vol. XXIV, p. 133, 1913. (Extinct lakes in N. Y.)
3. Fenneman, Wis. Geol. Survey, Bull., VIII, 1902. (s. e. Wis.)
4. Nichols, W. R., Bos. Soc. Nat. Hist., 1880. (Temperature of freshwater lakes.)
5. Russell, I. C., Lakes of North America, Ginn & Co. (New York, 1895.)
6. Sellards, Fla. Geol. Survey, 3rd Ann. Rept., 1910. (Florida.)
7. Smith, Jr., H., Trans. Amer. Soc. Civ. Eng., XIII, p. 73, 1884. (Temperature of lakes and ocean.)
8. Smyth, Jr., C. H., Amer. Geologist, XI, p. 85, 1893. (Lake filling).
9. Tarr, R. S., Physical Geography of New York State, Chapter VI, The Macmillan Co. (New York, 1902.)
10. Wilson, A. W. G., Bull. Geol. Soc. Amer., XIX, p. 471, 1907. (Shorelines on Lakes Ontario and Erie.)
11. Military Geology, Chapter on Lakes and Swamps. (New Haven, Conn., 1918.)
12. Salisbury, R. D., Physiography, Henry Holt & Co., N. Y., 1907.
13. Tarr and Martin, College Physiography, The Macmillan Co., N. Y., 1914.
14. Hobbs, W. H., Earth Features and Their Meaning, The Macmillan Co., N. Y., 1912.

References on Swamps

15. Bastin and Davis, U. S. Geol. Survey, Bull. 376, 1909. (Peat Swamps, Maine.)
16. Carey and Oliver, Tidal Lands, D. Van Nostrand Co., N. Y., 1918.
17. Davis, Assoc. Amer. Geographers, Annals, I, p. 139, 1911. (Salt Marshes.)
18. Follansbee and True, Rept. Nat. Conserv. Com., III, p. 361, 1909. (Swamp and overflow lands.)
19. Johnson, Shorelines and Shore Processes, John Wiley & Sons, N. Y., 1919.
20. Shaler, U. S. Geol. Surv., 6th Ann. Rept., p. 353, 1885. (Sea coast swamps, eastern U. S.); *Ibid.*, 10th Ann. Rept., Pt. I, p. 255, 1890. (Fresh-water morasses, U. S.)

CHAPTER X

GLACIAL DEPOSITS: THEIR ORIGIN, STRUCTURE, AND ECONOMIC BEARING

Origin and Nature of Glaciers

GLACIERS are not of great importance to the engineer, even though they may be of considerable scientific interest, but the work which they have performed in the past, and the deposits which they have built up are matters of considerable value to him, and often present interesting problems in connection with various subsurface operations, such as tunneling, dam foundations, aqueduct construction, underground water supply, etc. Glacial deposits sometimes serve also as a source of materials of economic importance.

While we shall concern ourselves especially with the latter phase of the subject, it must, for the sake of intelligent understanding, if for no other purpose, be prefaced at least by a few remarks on the way in which glaciers originate, and the work they perform.

Formation of snow fields. — In cold regions, such as high mountain tops, and in polar lands, the snowfall if heavy may remain throughout the year, forming a *perennial snowfield*.

At any point on the earth's surface, therefore, we may find a level, above which the snow accumulates, this level being known as the *snowline*. In the tropics the snow-line is from 15,000 to 16,000 feet above sea-level, in the Rocky Mountains of the United States about 10,000 feet, in the Selkirks about 8,000 feet, while at the poles it is nearly at sea-level.

The snow which thus collects above the snow-line is disposed of: (1) By evaporation, especially in dry regions; (2) by avalanches, when the snow collects on steep slopes; (3) by melting during warm days, and (4) by glaciers, in those regions where it cannot be entirely disposed of in some of the other ways.

Change of snow to ice. — If snow accumulates on the surface in quantity, the supply exceeding the waste, the mass becomes gradually compacted by its own weight, and also by alternate freezing and thawing, so that during the day when the surface layer of snow melts, the water trickles down through the cracks or pores and freezes again.

We thus get a granular mass which is between snow and ice in its character and is known as the *névé*. At a greater depth the *névé* becomes still more compact and grades into ice.

Ice motion. — If the snow and ice of a perennial snowfield accumulate in sufficient thickness, the ice begins to move, and while the exact nature of this motion is not clearly understood, the material seems to behave much like a viscous body. Such a mass of moving ice is called a *glacier*.

If the ice sheet accumulates on a comparatively flat surface, the flow may take place in all directions from a central point, but if the accumulation is on a slope, the latter will guide the direction of flow. Moreover, if such a slope is composed of valleys and ridges, the ice will be deeper in the former, or be confined to them entirely in its downward course.

Conditions essential to the formation of glaciers. — These are: (1) Sufficient atmospheric moisture; (2) temperature low enough during a part of the year to precipitate the moisture as snow; and (3) the snowfall during at least a part of the year must be in excess of the summer's melting, so that the accumulation of one year is added to the fall of the next, *etc.*, for a period of time.

Types of glaciers. — Depending then on the conditions of accumulation we can recognize three types of glaciers: (1) *Continental glaciers*, or those forming an ice cap covering a large part of a continent. (2) *Valley glaciers*, or those extending either from the edge of an ice cap as *polar glaciers* (ice tongues) or from a *névé* in the mountains, down into the valley forming *alpine glaciers* (Plate LVIII, Fig. 1). (3) *Piedmont glaciers*, or those formed by the merging of valley glaciers which have descended to the plain.

General features of glaciers. — The motion of a glacier, especially the valley type, bears some resemblance to that of rivers, the middle and top flowing faster than the bottom and sides, because these are retarded by the friction of the ice against the ground. While the ice flows, it is not exceedingly elastic, and comparatively slight irregularities of its bed, cause it to crack. It is therefore sometimes much broken by *crevasses*.

The rate of flow of the glacier ice depends mainly on the supply of snow, the grade, and the seasonal temperatures. The glaciers of the Alps advance at a rate of from two to fifty inches per day in summer and about half that rate in winter, while the vastly larger glacier which enters Glacier Bay in Alaska has a summer velocity of 70 feet per day in the middle (Scott).

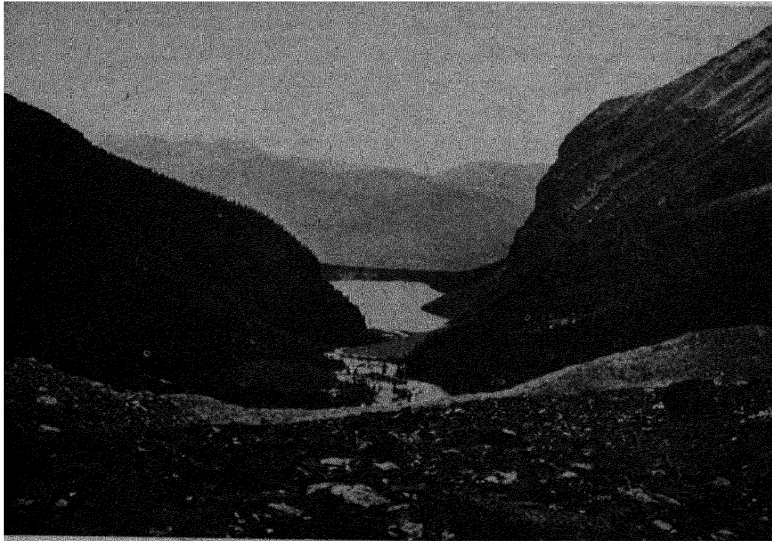

PLATE LVIII, FIG. 1. — General view of an alpine glacier, the Asulkan, near Glacier, B. C. Shows the reservoir or névé, with glacier descending from it; two lateral moraines on either side, which have been left as the glacier shrank in width; the crevassed ice fall, represented by roughened dark surface, just above curve in glacier. (H. Ries, photo.)

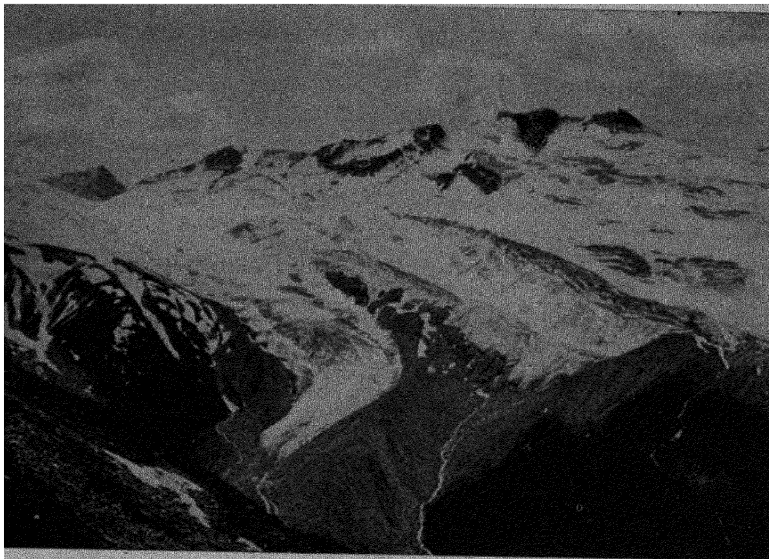

FIG. 2. — General view of Lake Louise, Alberta, from the Victoria glacier. The lake occupies a hanging valley, its waters being held in by a moraine at the lower end. In the foreground the débris-covered surface of the Victoria glacier, with two moraines at either side beyond. Sediment carried down by glacial stream is building out a delta at head of lake. (H. Ries, photo.)

As the ice stream descends from the snowfield or reservoir to lower levels, it melts slowly and diminishes in thickness, but the effect of melting is most noticeable at the lower end.

If now the rate of melting back at the lower extremity, and the rate of advance of the ice are balanced, the glacier appears to be stationary; if rate of advance exceeds rate of melting, the ice front advances, while under reversed conditions it appears to retreat.

Effects of advancing glaciers. — Advancing glaciers may cause damage in different ways. Several cases may be mentioned.

Glacier advance over territory not hitherto glaciated occasionally results in the destruction of forests in the path of the moving ice, but such cases are comparatively rare in modern times, although it has been noticed in Alaska.

In rare instances a glacier may advance across a valley, and dam the stream occupying the latter. There is then danger of the ponded water becoming suddenly released. Thus Geikie¹ states that "the valley of the Dranse in Switzerland has several times suffered from this cause. In 1818, the glacial barrier extended across the valley for more than half a mile, with a breadth of 600 feet and a height of 400 feet. The waters above the ice dam accumulated in a lake containing 800,000,000 cubic feet. By a tunnel driven through the ice the water was drawn off without desolating the plains below."

Marginal lakes held between the edge of the glacier and the moraine, or rock walls are not uncommon, and the change in position of the glacier sometimes permits their sudden release. There are many cases of damaging floods from the breaking of dams of marginal-glacier lakes. At Valdez, Alas., a few years ago such a flood swept away many houses, and on the Copper River Railway, in Alaska, a portion of a trestle was swept away.²

An interesting case of trouble caused by living glaciers is found in Alaska, along the line of the Copper River and Northwestern Railroad. The road, which has its terminus at Cordova, runs eastward across the great delta of Copper River, and here shifting glacial streams made railroad building very difficult, for the river is subject to great and rapid fluctuations of volume and load, so that quicksand bottom, erosion, deposition, channel shifting, and floating ice, all add to the engineers' problems. Farther up the line where the Niles Glacier has pushed across the valley, crowding Copper River to one side, the road was blasted out of the steep rock wall

¹ Textbook of Geology, 3rd ed., 1893, p. 382.

² Private communication from Col. L. Martin.

above the river, and the track here is exposed to rock and snow slides. Still farther up the route, the Allen Glacier was found to project clear across the main valley, and the engineers decided to build the road on the glacier itself. They accordingly blasted out a grade across $5\frac{1}{2}$ miles of a stagnant, moraine-veneerred, tree-covered ice mass. Ice lies beneath the ties, and future melting of it will cause slumping and repeated grading. If the glacier begins to advance there will be more trouble.¹

During the Glacial Period the continental ice sheet of North America in several cases formed a dam across valleys occupied by lakes, causing the water surface to rise as much as several hundred feet above its normal level. A fine example of this is seen in the valley of Cayuga Lake in New York State, where the numerous delta terraces observed at different levels on the valley slopes show the several levels at which the lake stood, while its waters were dammed by the ice during its retreat to the northward. Elevated shore lines around some of the Great Lakes were formed when their waters formerly stood at higher levels due to the same cause.

Additional trouble may be caused by streams fed by the melting snow and ice. During winter, or cold days and nights of summer, when little or no melting takes place, the streams flowing from the snowfields are sometimes of small volume, but on warm sunny days when the snow and ice melt rapidly, the volume of the streams is greatly augmented.

Care should be taken, therefore, to bear this in mind in constructing rail and wagon roads in mountain regions where there is an abundant accumulation of snow and ice.

Cases are known where roads constructed too near to the edge of a snowfed stream have been overflowed regularly on warm summer days, and in some instances undermined and washed away in places.

Glacial erosion. — Glaciers like rivers perform a certain amount of erosion which is so characteristic that it enables us to recognize the former existence of the ice, even though it has long since disappeared. How much erosive work they are capable of doing is a matter of dispute, but it must vary since it depends on the velocity of movement, amount of rock material held in their lower layers, the pressure on the beds, thickness of ice, and character of rock surface.

Erosion may be accomplished in several ways, as follows: (1) In moving over a surface not yet traversed the ice often removes the soil or other loose materials from it. (2) Rocks and sand, partly imprisoned in the lower part of the ice, when rubbed over a bare rock surface, and held down against it under great pressure abrade

¹ Martin, Bull. Amer. Geog. Soc., XLV, p. 801, 1913; Nat. Geog. Mag., XXII, p. 541, 1911; Tarr and Martin, Annals Assoc. Amer. Geog., II, p. 25, 1913.

the bed rock more or less, as well as polishing, scratching or grooving it in a very characteristic manner.

Glaciated rock surfaces are, therefore, easily recognized. They are sometimes very uneven, and hence in a glaciated region the bed rock often lies at a variable distance below the surface, a fact that engineers should remember in sinking foundations.

Erosion is also performed by a process known as *plucking*, which is the tearing away of joint blocks by the advancing ice.

Where glaciers have performed much erosion the topographic features are usually quite characteristic. Thus angular outlines are rounded off, and the cross-section of a glaciated valley is U-shaped with a broad bottom and steep sides. A river valley in contrast has a V-shaped cross-section, with projecting spurs. These latter are removed by prolonged glaciation. Lake valleys are sometimes deepened by glacial erosion, as in the case of the Great Lakes, and also the Finger Lakes of central New York.

If a main valley is deepened by glacial erosion, while its tributary is less, or but slightly deepened, the lower end of the latter will be above the former when the ice disappears, that is, the tributary will be discordant as to grade with its main valley, depending upon the inequality of deepening in the two valleys. The tributary valley is then known as a *hanging valley* (Plate LVIII, Fig. 2). Such valleys are not uncommon in some glaciated regions.

Glacial transportation. — Glaciers can transport material on their surface, within their mass, or in the bottom part of the ice.

The material which is carried on the surface consists of rock fragments of all sizes and other *débris* that has fallen on to the ice from cliffs and slopes that project above it. Sometimes the surface of the glacier in places is so completely covered by *débris*, that the ice is not visible (Plate LVIII, Fig. 2).

The bottom of the glacier is often a confused mass of ice, stones, *etc.*, and when deposited forms the ground moraine.

The englacial drift is either *débris* that has fallen into cracks from the surface, or has collected on the surface of the snow, and become covered by subsequent snowfalls. It is protected from wear by the glacier and can usually be recognized by its angular character.

Glacial Deposits

Surface moraines. — The *débris* which accumulates on the surface of a glacier is sometimes arranged in belts or bands which are called *moraines*. If the *débris* is heaped up in ridges on the side of the glacier

it is called a *lateral moraine*. If in a parallel position but some distance from the edge it is known as a *medial moraine*, and several of these may exist on the same glacier. Such moraines are sometimes formed by the union of lateral moraines when two glaciers join.

If the end of the glacier remains stationary or nearly so for some time, all the transported material, except that carried away by water, is dropped as the ice melts, and forms a more or less hummocky ridge at the end of the glacier, known as a *terminal moraine*.

Since ice does not sort material as does water, the terminal moraine, when not modified by escaping glacier waters, is unstratified and consists of materials of all sizes from silt and fine sand up to boulders weighing many tons.

If a glacier remains stationary for a considerable period of time, all things being equal, a moraine of large size may be built up, provided the glacier transports much material; or if during its recession the glacier halts for a time at different points a number of terminal moraines will be formed.

When a glacier melts slowly its débris is deposited as an irregular sheet, which constitutes the *ground moraine*. This is not stratified ex-

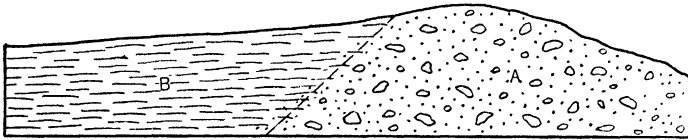

FIG. 188. — Section showing relation of overwash plain to a terminal moraine.

cept in those places where modified or formed by water. It consists of fine clay or sand with scattered boulders, the latter often showing scratches and is termed *till* or *boulder clay*. Drift is a general term applied to glacial deposits.

Nature of glacial deposits. — Glacial deposits are usually quite characteristic in appearance for several reasons: (1) The ice does not exercise a sorting action, so that we find boulders, cobbles, pebbles, sand and clay forming a confused mass; (2) the stones of the drift, although worn, are not rounded like those transported by water, but have a more or less subangular form; and (3) the stones are often striated and polished.

The moraines of pre-existing glaciers often form natural dams across valleys, obstructing the drainage, and creating lakes that serve as sources of water supply. As the material is not very permeable, little

seepage results. At other times the old moraines still remain as ranges of hummocky hills extending across the country.

Glacial-water deposits.—The water flowing from a glacier may carry vast amounts of *débris*, sometimes of considerable coarseness, and deposit the latter over the surface beyond the glacier margin. If this is deposited in valleys it is called a *valley train*, but if on a more or less flat surface of large areal extent, the term *outwash plain* or *frontal apron* (Fig. 189) is applied to it. Deposits of this kind are usually distinguishable from ordinary river deposits by the fact that they often grade into moraines, and that their constituents bear evidence of glacial origin. *Eskers* are long, winding gravel ridges, deposited by streams flowing in channels in the ice, or beneath it. *Kames* are short ridges of similar material piled up by glacial streams flowing from beneath the ice, frequently against the end or terminal moraine.

Past glaciation.—Glaciers in the past have accomplished similar work, and built up the same kind of deposits as existing ones. From such evidence, therefore, as glacial erosion, smoothed and striated rock surfaces, the deposition of moraines and other glacial drift including *poached* erratics of foreign rock, and general characteristic modification of the land surface (stream and interstream areas) by erosion and deposition, we can affirm that all of Canada, and the northern part of the United States were formerly covered by a vast continental glacier, which started from two or three centers to the north and moved from these centers of dispersion, probably outward in all directions. In the United States it extended to the line indicated on southern boundary of shaded area on the map (Fig. 190).

There was not one but several advances of the continental ice sheet, with periods of retreat between. As a result we find a sheet of glacial drift marking the extent of advance of the ice in each case, while stretching away to the southward are deposits of outwash sands and gravels.

It furthermore follows that the outwash gravels deposited during one advance of the ice may be covered by morainal material of a later advance.

In addition to the outwash gravels, there may be many lenses of poorly assorted gravel and sand, intermingled with the till in many places.

The map, Fig. 190, shows the principal areas of the United States underlain by glacial drift.

In the glaciated area of the United States and Canada we find a more or less continuous mantle of drift of variable thickness which is usually

deepest in the valley bottoms and thinnest on the interstream areas. In the United States it is thickest in a broad belt a little within the margin of the drift area, which extends from central New York through-

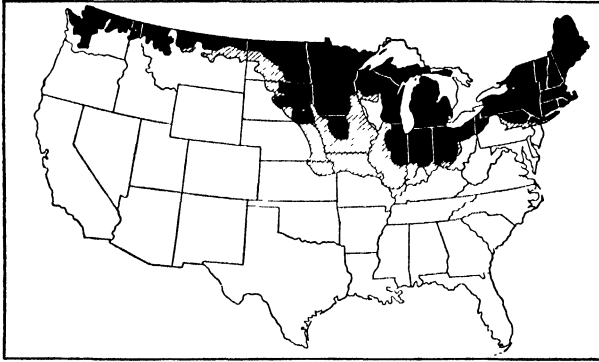

FIG. 190. Map of United States showing principal areas underlain by glacial drift. Black is the Wisconsin or latest drift sheet; light-shading indicates older drift. Outwash deposits and deposits of loess beyond drift sheets are not shown. After Alden in U. S. Geol. Surv., Wat. Sup. Pap. 489, 1923.

out Ohio, Indiana, Illinois, Iowa, Minnesota, and Dakota, and thence northward to an unknown limit in Canada.

Over any region the thickness of the drift may vary within short distances. The depth then to bed rock may be quite variable, and

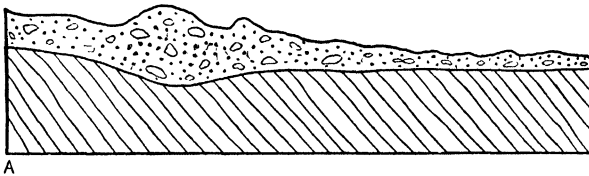

FIG. 191. — Section through glacial drift and bed rock, showing how the deposition of morainal material has made the surface more irregular.

the drift mantle either decreases or increases the relief of the surface (Figs. 191 and 192).

The vertical range is also great, for in New York State it is found from sea-level to nearly 5000 feet altitude in the Adirondacks.

The contact between the drift and the underlying rock surface is usually sharply defined for the reason that the continental glacier

removed in most places the residual soil, leaving the fresh and firm underlying rock.

Many of the rocks distributed through the drift are of kinds occurring many miles to the north of where they are now found. Large ice-transported boulders many tons in weight are also found scattered over the drift-covered area, regardless of topography.

Sometimes the drift is of great thickness even in places where one might not expect it. Thus at Mineville, N. Y., one of the mine shafts sunk on a hillside passed through 250 feet of drift before reaching bed rock. In southern Minnesota it is 0 to 300 feet thick.¹

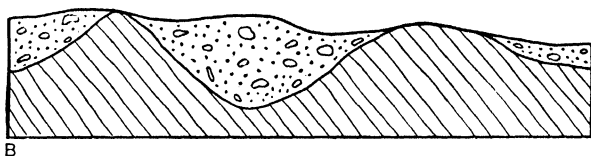

FIG. 192. — Section showing how the deposition of glacial drift has reduced surface irregularities.

Large boulders in the drift are sometimes mistaken for bed rock in drilling, especially where wash borings are made. In sinking test holes along the line of the Catskill aqueduct for New York City the drillers on Moodna Creek struck a glacial boulder at 15 feet and reported bed rock,² whereas the latter was 300 feet below the surface.

Topography of the drift. — The drift presents certain characteristic topographic features, such as: (1) Depressions without outlets; (2) knobs, hills and ridges of similar size to the depressions, associated with them; and (3) ponds often formed in the depressions.

The topography of a terminal moraine is more or less characteristic.

“ It sometimes constitutes a more or less well-defined ridge, though this is not its distinctive feature, since its width is generally great relative to its height. A moraine 50 or even 100 feet high and a mile wide is not a conspicuous topographic feature, except in a region of unusual flatness. In such situations terminal moraines sometimes constitute important drainage divides. The surface is often characterized by hillocks and hollows, or by interrupted ridges and troughs, following one another in rapid succession, and without apparent order of arrangement ” (Chamberlin and Salisbury).

¹ U. S. Geol. Surv., Wat. Sup. Pap. 256.

² Berkey, N. Y. State Museum, Bull. 146, p. 26, 1911.

Glaciation and Engineering Problems

Buried channels. — Many of the present streams occupy the partly or completely filled pre-Glacial Valleys. During the Glacial Period their valleys or gorges became completely clogged with glacial drift so that after the recession of the glacier these streams had to cut new channels. Abundant modification of stream drainage has resulted.

In some cases a stream has sunk its channel through the thickness of drift, in others not, while in still others the deflection to one side of its

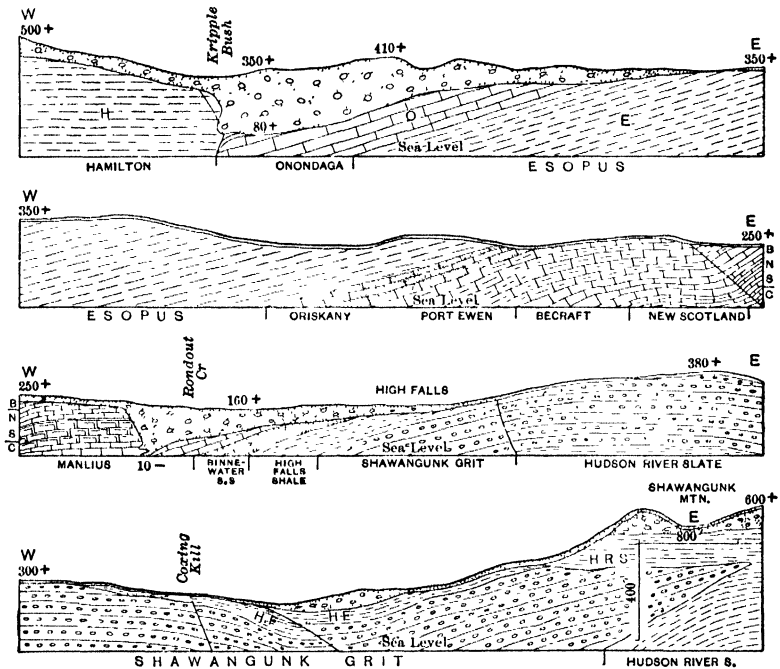

FIG. 193. — Sections across Rondout Valley, N. Y., showing pre-Glacial valleys which have been filled with glacial drift. (Berkey, N. Y. State Museum, Bull. 146.)

former valley, has enabled it to cut through into the underlying hard rock. Again others are flowing in new channels on the drift cover.

Tunneling and buried channels. — Tunnels sometimes encounter these buried channels. For example, in bringing the aqueduct tunnel from the Catskill Mountains to New York City, a number of these buried channels were encountered (Fig. 193), and it was necessary to carry the water under them by inverted siphons. The deepest was that of the Hudson Valley in the Highlands, where the tunnel had to be

carried 1000 feet below sea-level in order to get under the buried gorge of the Hudson.

Buried channels are also of importance in connection with underground water supply, for the gravels and sands that sometimes fill them may carry a sufficient supply of good water to be drawn upon (Fig. 156).

In central New York some of the streams tributary to the lakes now occupy post-Glacial gorges, while their buried pre-Glacial channels lie at the same level to one side. One of these buried channels was used to conduct a water pipe from a reservoir to a power house farther down the gorge. In another case it was noticed during the construction of a reservoir across a post-Glacial valley that the pre-Glacial channel left

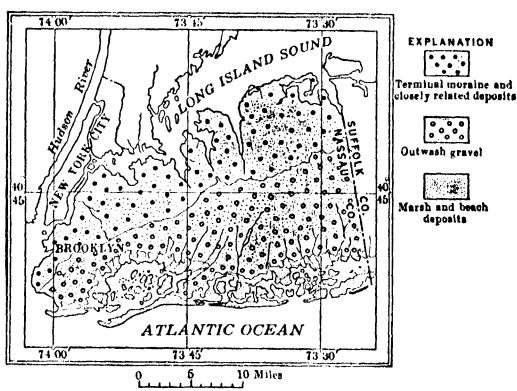

Fig. 194. — Map of Nassau County, Long Island, N. Y., showing water-bearing outwash gravel and its relation to the terminal moraine. (After Fuller, in U. S. Geol. Surv., Wat. Sup. Pap. 489, 1923.)

the stream a short distance above the dam. Some fear was at first felt lest there might be leakage from the reservoir through this channel. It was found, however, that the latter was choked with rather dense till.

Subsurface water supply. — Glacial till because of its frequently dense and unassorted character does not as a rule yield much water, except for shallow dug wells. The sand and gravel deposits made by streams flowing from the ice are important as water bearers, the outwash deposits being very important in the United States (see also Chap. VI).

The map, Fig. 194, brings out well the relation of the water-bearing outwash gravels to the terminal moraine.

Reservoirs. — Stratified sands and gravels of glacial deposits do not make a good foundation for a reservoir, unless the latter has a water-tight bottom, for these materials are as porous as a sieve. Till would be far less permeable.

Dam sites. — In the construction of dams across valleys in glaciated areas, it is sometimes necessary to construct them in glacial drift, which covers the bed rock. In such cases the drift should be carefully tested at different points to get a water-tight foundation, for the reason that within the till there are frequently pockets, lenses, or beds of sand and gravel which are permeable to water. Obviously, where several sites are available, that one will be the best, which contains the densest material, thus avoiding the danger of leakage under or around the ends of the dam.

At Decatur, Ill., borings made preparatory to locating a dam across, the Sangamon River at that point, showed that deposits of outwash sand and gravel lay between the different till deposits.¹

Near Seattle, Wash., a dam constructed across Cedar Creek had one end set on a mass of permeable glacial drift, resulting in considerable loss by leakage from the reservoir.²

In selecting a dam site for the reservoir that is to supply the new Catskill aqueduct leading to New York City, the engineers found two locations, known as the Olive Bridge (Fig. 196), and the Cathedral gorge or Tongore site (Fig. 195), either of which seemed possible from a topographic standpoint. Both, however, were carefully explored by trenches, shafts, and boreholes.

In each case it was found that the bed rock had an uneven surface, that there was a buried gorge of Esopus Creek, and that the glacial deposits were over 200 feet thick in the narrow valley, as shown by sections.

The Olive Bridge site was chosen because of: (1) Higher bed rock surface throughout; (2) more uniform and impervious character of the drift; (3) more massive cross-section of the drift barrier for the foundations; (4) perfectly tight contacts of till and bed rock; and (5) restriction of more porous materials to the higher levels of the section.

Quarrying operations. — The continental glacier has indirectly affected quarrying operations. Thus in the states lying within the glaciated area, the residual soil and partly-decayed rock have been removed, and the quarryman usually finds sound stone at bed rock

¹ Leighton, M., Eng. News Rec., XCI, No. 7, Aug. 16, 1923.

² Fowler, C. E., Eng. News, Vol. 73, p. 112, 1915.

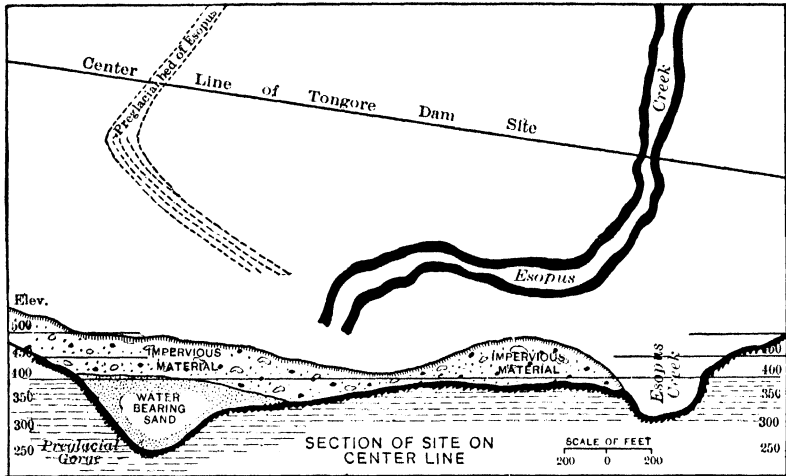

FIG. 195. — Section through Tongore dam site, tested for Catskill, N. Y., aqueduct. (After Berkey, N. Y. State Museum, Bull. 146.)

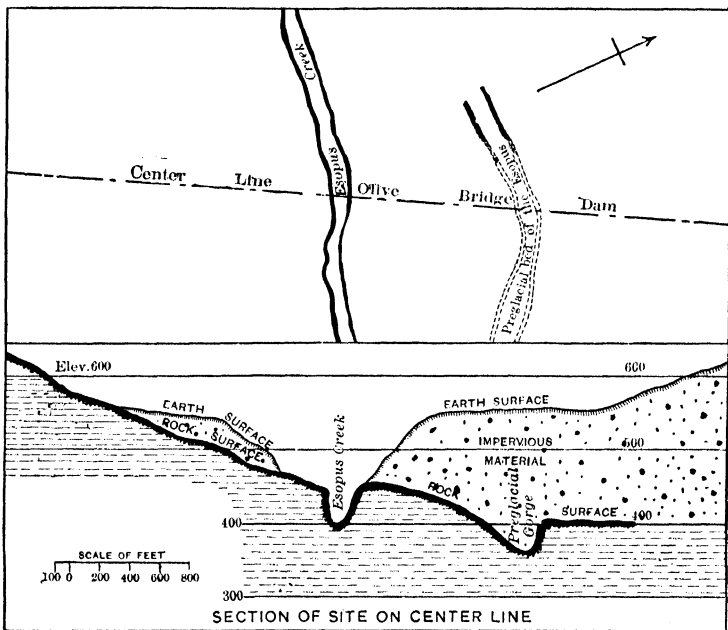

FIG. 196. — Section through Olive Bridge dam site, tested for Catskill, N. Y., aqueduct. (After Berkey, N. Y. State Museum, Bull. 146.)

surface, but south of the glaciated region, the residual soil and partly-decayed rock still remain, and stripping to some depth is often necessary to reach fresh rock.

Water powers. — Attempts are sometimes made to show that the continental glacier was an indirect cause in the development of abundant water power. However, this view may be a somewhat exaggerated one, as many important water powers exist and are being developed outside of the glaciated area. It is true, of course, that a considerable fall is sometimes obtained in post-Glacial valleys, and at the mouth of hanging valleys, which can be used for power purposes.

Economic materials in glacial deposits. — Owing to the diversified nature of the glacial drift, it contains a variety of materials of economic value. The masses of clay found in moraines and glacial-lake basins can be, and are used frequently for brick manufacture. Beds of sand and gravel occurring in the moraines and modified drift are employed for mortar work, railway ballast, concrete, cement blocks, foundry molds, sand-lime brick, glass manufacture, and filter plants.

References on glaciers

1. Berkey, C. P., *Geologic Features and Problems of the New York City (Catskill) Aqueduct*, N. Y. State Museum, Bull. 146, 1911.
2. Chamberlin & Salisbury, *A College Textbook of Geology*, New York, 1909. (Henry Holt & Co.)
3. Salisbury, R. D., *New Jersey Geol. Surv., Final Report*, V. 1902.
4. Atwood, U. S. *Geol. Surv., Bull.* 685, 1918. (Relation of landslides and glacial deposits to reservoir sites.)
5. Meinzer, *Ibid.*, *Wat. Sup. Pap.*, 489, p. 283, 1923.
6. Alden, U. S. *Geol. Surv., Prof. Pap.* 34 and 106.
7. Nevin, N. Y. *St. Mus., Bull.* 282, 1929. (Origin and uses glacial sands and gravels.)

Many of the geological surveys of states lying within the glaciated region have published special bulletins or reports on their glacial deposits. The United States Geological Survey has also issued a number. Most of these are written from the purely geologic standpoint. They may be of value to engineers in the areas of which they treat, since they give information regarding the thickness and character of the drift.

CHAPTER XI

GEOLOGY OF RESERVOIRS AND DAM SITES¹

The geologic examination of reservoirs and dam sites has within the last few years become a matter of recognized importance, its necessity having been well emphasized by the leakage from a number of reservoirs or the failure of dams due to unfavorable geologic conditions. Briefly expressed, the object of such an examination is to discover geologic facts which have a bearing on the water tightness of the reservoir basin, or on the safety, effectiveness and cost of the proposed dam.

The amount of time required for such an investigation depends of course on the size of the project as well as other conditions, and though in some cases it may involve considerable expense, the results are worth the outlay involved.

Reservoir and dam site geology compared. — A distinction must be made between the geology of the reservoir site and that of the dam site, although the two have certain problems in common. Geologic work on the reservoir covers the entire area over which the water is to be impounded, and relates almost entirely to conditions that will produce leakage or relative water-tightness. Geologic work on the dam site relates to a small area, and deals not only with the strength and stability of the rocks, but also their permeability and probable behavior when exposed to water under pressure.

The safe location of the dam is more important than that of the reservoir, for though the reservoir may leak without doing any serious damage, the sudden failure of a large dam releasing a great volume of water may mean a catastrophe costing many lives and destroying thousands of dollars worth of property. An outstanding example of this was the breaking of the St. Francis dam in California, where the volume of water suddenly freed took a toll of over 200 lives, to say nothing of the other damage done. (Fig. 196*a*.)

Requisite conditions for reservoir site (including dam). — The following general requisites are stated by Lippincott:²

¹ Tech. Pub. 215, of Amer. Inst. Min. Met. Engrs., contains a number of papers by Bryan, Matthes, Glenn, Terzaghi, Wentworth, Meinzer, Fisher and Stearns, on the subject discussed in this chapter. They have been freely drawn upon.

² U. S. Geol. Surv.. W. S. Pap. 58, 1902.

1. Tight basin of ample size.
 2. Narrow outlet requiring relatively small and economical dam, with safe foundations.
 3. Opportunity for building safe and ample spillway to dispose of surplus water.
 4. Available materials of which to construct the dam.
 5. Assurance that basin will not silt up in too short a time.
 6. Ample and available water supply.
 7. Use for stored water or other adequate reason to justify the cost.
- The first five of these involve a consideration of geologic conditions.

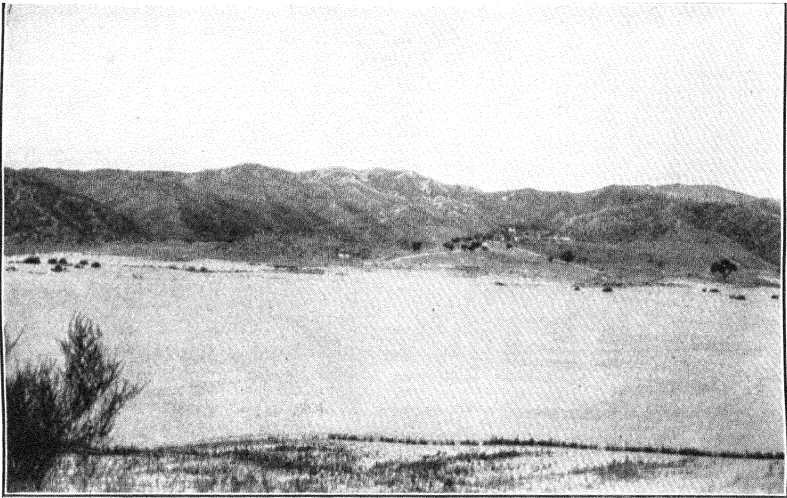

FIG. 196a. — View across Santa Clara valley, California, showing sandy waste left after flood caused by breaking of St. Francis dam. (H. Ries, photo.)

Geologic work on reservoir. — Geologic work on the reservoir site is essentially groundwater work, for when the reservoir is filled at least some water will soak into the ground, and the problem is whether the quantity so lost is likely to be sufficient to make the project a failure.

The degree of tightness required of a reservoir may depend somewhat on the use to which the water is to be put. If for domestic or power purposes much leakage is undesirable. If for flood control, even appreciable leakage may do no particular harm. If for irrigation, considerable leakage may be of little objection, provided the water lost finds its way into the stream below the dam and above the outlets for the irrigation canals.

Of primary importance is a study of the groundwater, its position

and movement, in the area adjoining the reservoir site in order to determine how the filling of the reservoir will affect these. The position of the water table is therefore one of the first things to be considered.

As explained under subsurface water (p. 309), the water table in general follows the surface topography, being higher under the hills and lower under depressions, although there may be exceptions, the water table in open-rocks being often low. Its surface may therefore slope toward the valley, (Fig. 196b) while under the latter it slopes downstream.

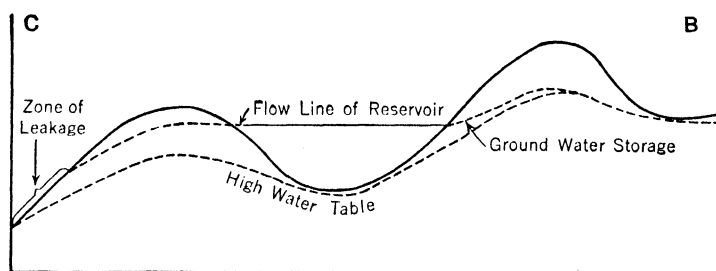

FIG. 196b. — Diagram showing relation of reservoir level to high water table. (After Bryan, U. S. Geol. Surv., Wat. Sup. Pap. 597.)

A steep water table indicates tight ground or large quantities of water, whereas a flat one suggests large openings in the rocks or small quantities of water.

High and low water table. — In areas of high water table, the latter has a form similar to that of the surface topography, sloping toward the valley, whereas in those of low water table the latter may be comparatively flat, and some distance below the surface.

Areas of high water table. — If a dam is placed across a valley, and the water impounded behind it, the water from the lake so formed soaks into the ground until it meets the water table, and consequently changes the grade of the latter (Figs. 196b, 141). If the surface of the reservoir is below the groundwater divide (Fig. 196b), there will be no loss by seepage, and groundwater will flow into the reservoir. In addition there will be underground storage between the old and the new position of the water table. The volume of this newly saturated ground will depend on the level of the reservoir and the slope of the original water table, and its value as a storage space will depend not only on the volume of pore space in it but also on the freedom of movement of the water to and from it as the level of the reservoir changes.

Should the groundwater divide be lower than the reservoir flow line, then the groundwater forms an underground spillway, and there may be leakage on the opposite side of the ridge (Fig. 196*b*, *C*). The volume of this leakage will depend on the nature of the material. If fine-grained the leakage will be moderate, but if open-textured, or cavernous, it may be great, with a corresponding lowering of the groundwater divide.

Meinzer points out that the laws controlling leakage are the same as those controlling the natural flow of groundwater.

Thus where the water is percolating through small interstices, it follows Darcy's law, *i.e.* The rate of flow is directly proportional to the permeability of the material through which the water percolates, the cross-section of the area through which percolation occurs, and the hydraulic gradient. If the underground flow takes place through caves and large crevices then the flow is more nearly that of a surface stream.

Streams which are fed by water from the higher lying water table on both sides of the valley are said to be *effluent*.

Springs in a reservoir site are a favorable indication of a water table sloping toward the valley. If they are large, attention should be given to their discharge pressure, for if it is insufficient to raise the water to the reservoir level, the flow may be reversed when the reservoir is filled, but since this head is not directly measurable, it must be determined indirectly from the level of the water table in the surrounding area.

Leakage through the rim material of a reservoir will vary according to the character of the material. That through basalt is constant or increases but slightly. In soluble rocks like rock salt, gypsum, or limestone, the leakage will increase due to solution of the rock, or washing out of debris from caves. Material consisting of boulders or gravel may increase due to fine material being washed out from between the coarser particles, and this may also be followed by slumping or even landslides. On the other hand silt may be carried from the reservoir into the interstices of the rim material and fill them up. This silting up is probably more effective in fissured rock than in unconsolidated or cavernous material.¹

Reservoirs with deep water table. — A deep water table is likely to occur in areas where the rocks are exceedingly porous or contain large

¹ For examples of silting up of fissures see: Strange, Inst. Civ. Eng., London, Proc. CXXXII: 137, 1898; Hill, *Ibid.*: 208. For leakage see Fowler, Eng. News, LXXIII: 112, 1915; Atwood, U. S. Geol. Surv., Bull. 685: 23, 1918.

openings. Conditions favorable for a deep water table are soluble rocks, basalt flows containing open cracks, brecciated, vesicular and scoriaceous portions, fractured rocks due to faulting or other movements, and coarse boulder beds. Deep water-table conditions may exist over large areas, or occasionally they are local. The water table is comparatively flat, and the groundwater flows freely with a low gradient.

Fig. 196c illustrates the conditions described above. It will be seen that wherever the walls and bottom of the stream channel are permeable there will be loss from the stream into the rocks. Such a stream is known as an *influent* one.

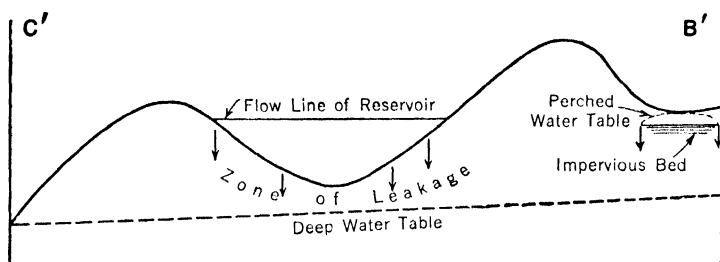

Fig. 196c. — Section showing relation of reservoir level to low water table. (After Bryan, U. S. Geol. Surv., Wat. Sup. Pap. 597.)

Bryan cites a case¹ where the basin of a proposed reservoir site in basalt was flooded to a depth of 15 feet and lost all its water by seepage in six weeks, even though the bottom was covered by silt. Several other cases noted by him are as follows:

1. Jerome Reservoir in Idaho, situated in a depression underlain by several hundred feet of basalt flows, and the water table far below the surface. Although there was a soil cover which in places was as much as 10 feet thick, the loss by seepage was so great that the reservoir had to be abandoned.
2. Hondo Reservoir, New Mexico. The natural depression occupied by the reservoir is surrounded by fairly substantial limestone, but there is a floor of shale and gypsum, with the water table about 200 feet deep. Here again excessive leakage caused abandonment of reservoir.

In some cases leakage may gradually diminish due to saturation of underlying ground.

Thus in the case of the Deer Flat reservoir in Idaho, located on an

¹ U. S. Geol. Surv., Wat. Sup. Pap. 597-A: 8

undulating plain between the Boise and Snake Rivers, two embankments close gaps in the encircling hills, but are not absolutely tight and allow some seepage at the base. There was a relatively large loss of water at first through the floor and sides, but it has gradually diminished. Prior to construction of the reservoir the water table in the underlying sediments, clays, tuffs, and sands rose above river level but did not closely approach the surface. The leakage assisted in saturating the ground, and more water soaked in from irrigation. Similar building up of a zone of saturation has been noticed around the storage reservoirs along the South Platte River in Colorado.¹

Perched streams. A perched stream is one whose bed is separated from the saturated zone by a dry zone² (Fig. 196c). It is *semiperched* if the zone of saturation extends up to the bed of the stream, but slopes away from it in both directions.

The Rio Penasco, a tributary of the Pecos River, which flows from the Sacramento Mountains³ is a good example of a perched stream. For many miles it is a perennial stream, which flows over a cavernous limestone, with the water table several hundred feet below the surface. The river, however, is fed by large springs which have built up extensive deposits of travertine, and this same material has cemented the channel gravels, as a result of which there is only a moderate loss of water due to leakage. If, however, this cemented gravel becomes broken up during floods, or at a ford where wagons cross, considerable leakage follows. Such a location would be regarded as a dangerous site for a dam or reservoir.

Other cases of perched streams are found on the Pecos River, near Carlsbad, N. Mex.⁴, and by Henry's Fork of the Snake River at the Island Park Site, in Idaho.

Rock types in relation to reservoir construction. — It is a well recognized fact that rocks vary as regards their resistance to percolation of water, and hence loss from the reservoir by leakage.

Rocks of low permeability. — Those rocks which seldom permit leakage include: granite and similar crystalline rocks, gneiss, schist, slate, quartzite, shale, sandstone and other fine grained ones. Some of these rocks may cause difficulty at dam abutments, but it is only under exceptional conditions that they allow water to leak from the reservoir.

¹ Parshall, Colo., Agr. Exper. Sta., Bull. 279: 58, 1922.

² Meinzer, Amer. Inst. Min. Met. Engrs., Tech. Pub. 215, 1929.

³ Meinzer, Amer. Inst. Min. Met. Engrs., Tech. Pub. 215, 1929; Renick, N. Mex. State Eng. 7th Bienn. Rep. pp. 109, 110, 127 and 128, 1926. Also Nye, N. Mex. State Eng. 8th Bienn. Rept., p. 179, 1928 (Cactus flat site, N. Mex.)

⁴ Meinzer, Renick and Bryan, U. S. Geol. Surv., Wat. Sup. Pap. 580, 1927.

Meinzer states that even a sandstone which yields water freely to wells may allow the water to percolate through it so slowly as not to be a serious cause of leakage. Moreover in some cases silt may get drawn into the pores or cracks and clog them up.

Rocks of high permeability. — The rocks most likely to permit serious leakage from a reservoir are: limestones and other soluble ones, basalts and other volcanics, gravelly deposits of glacial drift and alluvium. Each of these are referred to below in more detail.

Basalts,¹ and even some other volcanics, are always to be looked upon with suspicion, for although the interior portion of a flow may be dense, the top and bottom of the flow, or the contact with another flow, may be broken and highly permeable. A number of small flows, one on top of another, may be particularly bad. Coarse fragmental volcanics may also give rise to strong leakage.

Even in basalts however the permeability may vary depending on its age and mode of origin. Intrusive basalt for example is practically impermeable and the joint cracks carry but little water. Massive flows having a thickness of 100 feet or more are likely to be of low permeability. A few like this occur in Oregon and Washington. The Columbia River flows are more massive than the younger ones of the Snake River plains, but even so they may be sufficiently permeable to be unsatisfactory for reservoir construction.²

Stearns remarks that "the failure of reservoirs in basalt is generally due either to the water table being far below the floor of the reservoir, with only permeable rock intervening, or to the proximity of a canyon or coulee of an ancient stream course, now buried, into which the water may percolate through the permeable basalt."

As a rule acid and intermediate volcanics are less permeable than basalt, although obsidian and rhyolite are occasional exceptions to this rule, as evidenced by the strong springs sometimes found in them.³ The volcanics of the older geologic formations, are usually less permeable than the younger ones.

Limestones, including dolomite and marble, are always a possible source of danger, for they are easily soluble rocks, and there may be numerous underground solution channels developed along joints, bedding planes or other fractures. Their appearance is sometimes deceptive, due to the hardness and firmness of the rock. Solution

¹ See Meinzer, case of Joy reservoir site, Amer. Inst. Min. Met. Engrs., Tech. Pub. 215: 23, 1929.

² Stearns, Amer. Inst. Min. Met. Engrs., Tech. Pub. 215: 111, 1930.

³ Meinzer, Wat. Sup. Pap., 489: 142, 143, 1923; *Ibid.*, 557: 42, 43, 53, 1927.

cavities, however, are not necessarily present throughout a series of limestone beds, for, as pointed out by Meinzer,¹ the bottom of a reservoir site might be water-tight and the sides cavernous and leaky. Cavernous conditions are sometimes indicated at the surface by sink hole topography, but in others surface evidence may be lacking.

Gypsum is even more soluble than limestone.

If there is a water table present in cavernous rocks it is usually adjusted to underground streams.

In some reservoir sites leaks may be found which are of a local nature and these can sometimes be closed off by means of a dike, or grouting of the area.²

Coarse gravel may be as serious a cause of leakage as limestone and basalt. Deposits of such material may, moreover, be of irregular occurrence, since they may be found in moraines, alluvial fans or stream channels, and form a part of the natural wall of the reservoir, so that it may be difficult in some cases to determine the form or outline of these gravelly masses. Leakage through gravel would be in accordance with Darcy's law, and the width of a ridge along the reservoir would be of importance, for while a narrow one at the lower end would be bad, a broad ridge near the head of the reservoir would be much less serious. Leakage through sandy or gravelly material may at times be serious, and traverse a considerable thickness of material.

At the Cedar River reservoir in Washington, the south end of the dam was set on seamy rock, and the north end on glacial drift. Although there was some percolation through the rock, there was a large amount through the drift, totaling some 30 million gallons daily, and causing a slumping of the hillside.³

At the Santa Maria reservoir in Colorado leakage took place through two miles of landslide débris; at the Mosca Reservoir in Colorado the water seeped through 1500 feet of sand and gravel, causing a washout.⁴

As stated by Meinzer,⁵ "the lower end of a reservoir is usually the most critical end. Here the water is impounded to the greatest height above the original stream level and is unavoidably raised far above the water table. Moreover, the natural walls of the reservoir generally have the least thickness at the lower end. With great difference, within

¹ U. S. Geol. Surv., Wat. Sup. Pap., 557, 1927.

² Eng. News-Rec., LXXVI: 459, 1913. (Black River, N. Y.); *Ibid.*, XCVI: 561, 1926 (Malad Reservoir, Idaho).

³ Fowler, Eng. News., LXXIII: 112, 1915.

⁴ Atwood, U. S. Geol. Surv., Bull. 685: 23, 1918.

⁵ Amer. Inst. Min. Met. Engrs., Tech. Pub. 215: 23, 1929.

a short distance, between the water table and the water level in the reservoir, a steep hydraulic gradient away from the reservoir will result, with corresponding danger of excessive leakage. There may be instances of water leaking through gravel and reappearing in the river downstream from the dam where it can be used for irrigation.¹

Leakage through fissures. — Where leakage takes place through fissures in an otherwise sound rock it sometimes may cease or diminish greatly by silt accumulating in the cracks. Bryan cites the case of a dam in India where leakage occurred through cracks in schist, but these silted up after twelve years.² In Yorkshire, England, there was a leakage of 440,000 gallons per day through rock fissures, which silted up in two years.³

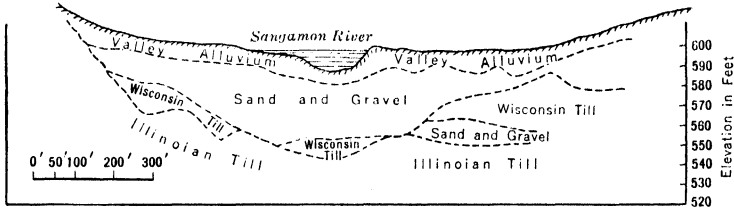

FIG. 196d. — Section across Sangamon River Valley at Decatur, Ill.
(After Leighton.)

Glacial drift. — In glaciated regions special attention should be given to the thickness of the drift and its relation to bed rock. Pre-glacial buried valleys are by no means uncommon and may be filled with dense till or porous sand and gravel (Fig. 196). In some areas the course of a post-glacial valley may cross a pre-glacial one. As a result the valley sides, instead of being all bed rock, may, at the points of intersection of the two valleys, be of unconsolidated and possibly permeable material.

Moraines may contain beds or lenses of gravel and sand; or in some cases outwash material may be buried under morainal till. A condition of this sort should be carefully determined, and may be specially dangerous if it forms part of the dam foundation⁴ (Fig. 196d).

Silting of reservoirs.⁵ — Since in some regions the streams carry considerable sediment, which settles in a reservoir, this is a subject

¹ Crandall, Amer. Inst. Min. Met. Engrs., Tech. Pub. 215: 28, 1929 (Mackay reservoir, Idaho).

² Strange, Inst. Civ. Engr., London, Proc. CXXXII: 137, 1898.

³ Hill, discussion of Strange's paper, *Ibid.*, p. 208.

⁴ Leighton, Eng. News-Rec., XCI, No. 7, Aug. 16, 1923.

⁵ See Glenn Amer. Inst. Min. Met. Engrs., Tech. Pub. 215, 1929; Bryan, U. S. Geol. Surv., Wat. Sup. Pap. 597: 7; Bryan, Nat. Res. Council., Researches in Sedimentation in 1925-26, 1926 (extensive bibliography).

requiring careful attention, wherever there is any danger of it, for in some regions the silting up of basins is a rapid process.

Glenn states that some power reservoirs in the southern Piedmont region have filled in two or three decades, and that some western irrigation reservoirs are collecting sediment at such a rate as to fill them in 75-125 years. The reservoir at Austin, Texas had silted up 95 per cent in a period of a little over a decade after it was built.

In a glaciated country the danger from silting appears to be less. In some cases the silty sediment is loose and can be easily flushed through the dam, but in others the material is a tough clay which may resist such treatment.

Examination of Reservoir site. — This should first include a careful examination of the rocks in the bottom and sides of the depression. If these are all of relatively impermeable and insoluble character, additional examination can be restricted to the dam site, abutments, or places where the divide is narrow, and the top may be approached by the proposed flow time.

Permeable rocks like limestone, gypsum and basalt require careful examination. In limestones the underground drainage may show little or no relation to structure. If volcanics are present attention should be given to the source of the flow, its course and relation to pre-existing surfaces.

A careful study should be made of the position and depth of the water table, location of springs and their discharge. The study of the water table may require the drilling of wells.

Underground streams should if possible be located, and their course in some cases traced by dyes.

If the valley bottom is floored with alluvium it will be desirable to determine its nature and depth, as well as the character of the underlying rock.

Geologic work on dam sites. — The general problems involved in the case of dam sites are depth to bed rock, strength of the rocks, and perviousness of the foundations and valley walls.

Rock channel. — It is desirable to have the dam rest on solid rock if possible, and since the bottom of the valley at the dam site is often filled with unconsolidated material, which in turn may be covered with water, careful study may be necessary to determine the form and depth of the rock channel. The mere fact that rock may outcrop in the channel is no proof that the alluvial filling is everywhere shallow.

If the dam is to be set on channel filling, it is also important to determine its nature, whether gravel, sand, clay, boulders, or a mixture

of these, and the relative form and distribution of each kind of material, because it has a bearing on the perviousness of the foundation material.

Rock types and dam foundations.¹ — Consolidated rocks are naturally better than unconsolidated ones, but aside from this the position of the beds, and alternations of strong and weak rocks may complicate the problem.

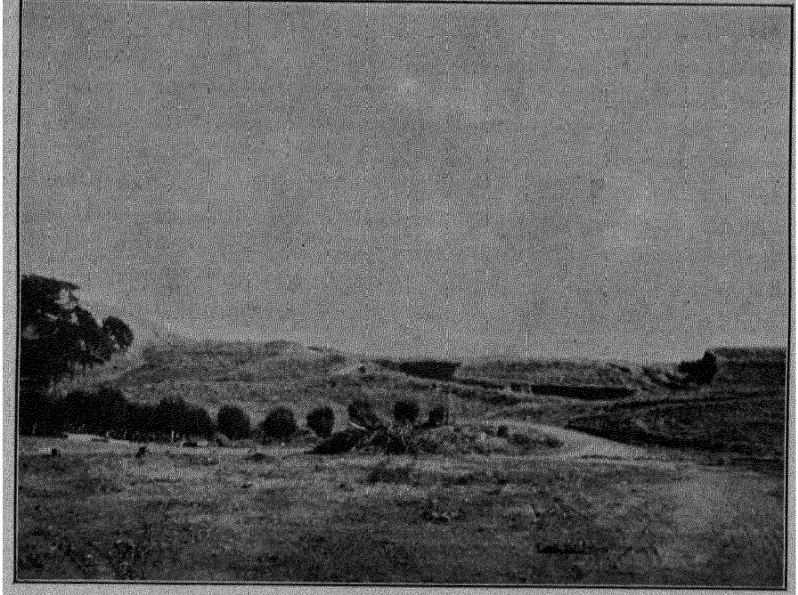

FIG. 196e. — View of Lafayette dam east of Berkeley, Calif. The notch on right shows cut formed by settling of dam due to low bearing power of underlying sediments. (H. Ries, photo.)

Certain hard rocks like granite, gneiss, sandstone, massive limestones, have excellent bearing power if free from structural or other defects.

Schists are of variable strength, but Glenn states that quartz and hornblende schist are usually strong enough.

Mica schists, because of their easy cleavability are less safe; and shales are still weaker. Of the latter the highly siliceous and well indurated shales are the best, while argillaceous shales may slake and consequently soften when wet.

If shaly beds lie between sandstone or limestone layers they may also

¹ Glenn, Amer. Inst. Min. Met. Engrs., Tech. Pub. 215: 103, 1929.

cause trouble if water seeps along them, as they are likely to soften and allow movement of the foundation rock.

Poorly cemented sandstones, porous limestones, tuffs, certain breccias and agglomerates, may be massive but deficient in strength.¹

Unconsolidated materials such as gravel, sand and clay are much weaker than consolidated rocks, but may vary in resistance depending on their dryness, grain size and shape, or even other factors. Since they may be very porous, a cut-off wall or sheet-piling may be constructed to prevent percolation. Indeed where they serve as foundation material the dam may be constructed of low height and wide base. Even so the weight of the dam may exceed the bearing power of the material, as in the case of the Lafayette dam, east of Berkeley, Calif. (Fig. 196e).

This was an earth dam set on alluvium. The crest had been built to a height of about 120 feet, or within 10 feet of the proposed height, when the top settled about 20 feet.

LaRue² and Bryan³ have given quantitative data for determining the ability of natural foundations to stand the load of a high masonry dam.

The following standard table is intended to give the bearing capacity of consolidated and unconsolidated rocks.

	<i>Tons sq. ft. = 138.81 lbs.</i>	
	<i>Min.</i>	<i>sq. in. Max.</i>
Rock, the hardest in thick layers in native bed	200	
Rock equal to best ashlar masonry	25	30
Rock equal to best brick masonry	15	20
Rock equal to poor brick masonry	5	10
Clay, in thick beds, always dry	6	8
Clay, in thick beds, moderately dry	4	6
Clay soft	1	2
Gravel and coarse sand, well cemented	8	10
Sand, dry, compact, well cemented	4	6
Sand, clean, dry	2	4
Quicksand, alluvial soil, etc.	5	1

Just as unconsolidated materials show a lower bearing power when wet, so some consolidated rocks when water-soaked may show lower compressive strength.

The watersoaking of a conglomerate at the St. Francis dam in California was probably largely responsible for its failure, for the material

¹ Bryan, U. S. Geol. Surv., Wat. Sup. Pap., 597: 16, 1929.

² U. S. Geol. Surv., Wat. Sup. Pap. 556: 20, 1925.

³ Amer. Soc. Civ. Eng., Trans., LXXXVI: 228, 1923.



FIG. 196*f*. — Soft conglomerate with gypsum seams. Foundation rock of part of the St. Francis dam. (H. Ries, photo.)

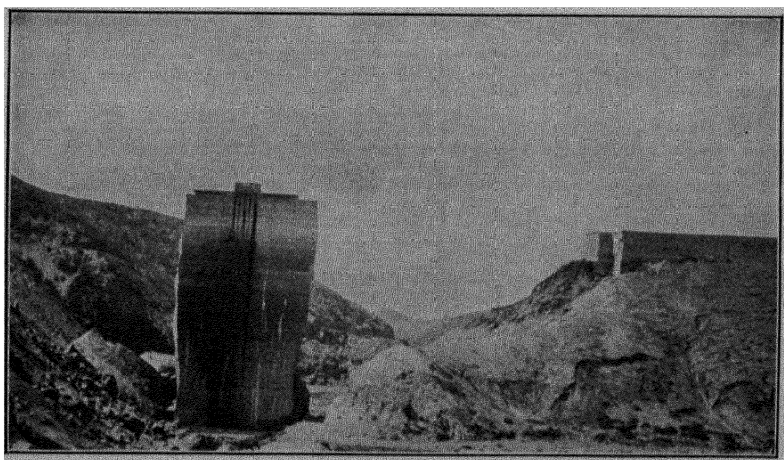

FIG. 196*g*. — St. Francis dam after its failure. Rock on left schist, and on right soft conglomerate. The two join along a fault on slope just to right of standing section. Dam 275 feet high. (H. Ries, photo.)

contained much clayey cement as well as seams of gypsum¹ (Figs. 196*f*, 196*g*).

A single piece of consolidated rock may show sufficient strength on testing, but when in the ground where it is traversed by clay seams along joints or bedding planes, its bearing power may be reduced. Moreover, the forcing of water into these joints may initiate a slipping movement, which is fatal to the dam.

Engineers in a few instances have made bearing tests on the material in the ground, particularly in the case of unconsolidated or poorly consolidated rock.²

A single field load test of agglomerate at the site of the proposed Iron Canyon dam in California indicated a strength of 40 tons per square foot without signs of failure. The engineers decided that the dam should impose only half that load. This large safety factor was allowed because of three uncertainties, viz. (1) only one test had been made; (2) the test was made on dry rock; and (3) the resistance of the rock might be lower under long continued load.

Rock strength in relation to structure.— In stratified rocks the strength is somewhat greater with reference to stresses applied normal to the natural bedding planes than if applied in other directions.

This being the case, horizontal beds should offer the best support for the weight of the dam.

The resultant of the components of the weight of the dam and the horizontal water pressure will be inclined and dip downstream; consequently the beds should offer the best resistance to these combined stresses if they dip upstream, say at an angle of from 10° to 30°.

Since displacement takes place most easily parallel to the bedding planes, these should be at right angles to the direction of stress, which means that they should strike across the channel, and not parallel to it.

Failure of a dam located on horizontal beds of consolidated rock are not as a rule due to its weight, but may be caused by undermining of the structure at its toe or to uplift pressure (see p. 446*p*).

Failure due to slipping of the rock along the bedding planes is more common.³ (See Fig. 168.)

¹ Ransome, *Econ. Geol.*, XXIII: 553, 1928.

² See Iron Canyon dam. Calif., *Reclam. Rec.*, XI: 378, 1920; Capitol at Lincoln, Neb., *Eng. News-Rec.*, LXXXIX: 606, 1922 and XCIV: 107, 1925; Columbus, Ohio, *Eng. News-Rec.*, XCVI: 109, 1926; Cleveland, Ohio, *Ibid.*, LXXX: 363, 1918; Terzaghi, *Eng. News-Rec.*, XCV, Nov. and Dec., 1925.

³ Taylor, Austin, Tex., dam, *Wat. Sup. Pap.* 40, 1900; Purdue, Res. Tenn., III: 106, 1913.

Leakage under dam. — Seepage under a dam may be due to a variety of conditions such as the presence of porous sand and gravel, cavernous limestone, basalt, open joints or bedding planes, crushed rock or folds. This seepage may result in loss of water from the reservoir, or in failure of the dam due to washing out of foundation material, or uplift pressure. Limestone should always be looked on with suspicion as it may contain solution cavities, capable of permitting considerable leakage.

One of the outstanding cases of this is the Hales Bar dam on the Tennessee River, which Matthes¹ has called the "greatest object lesson in the history of engineering foundations." According to Switzer,² 10 million pounds of cement were used to grout up the open cavities in the limestone, but there were others filled with clay, which was washed out by the water pressure, and these were later filled with great quantities of hot asphalt, which has reduced the leakage effectively.³

Although limestone is often cavernous, nevertheless some large dams which are both water-tight and stable have been built on this kind of rock,⁴ as one in southern Spain, 273 feet high and 200 feet long, a second for Baker Power Plant, in Washington, 263 feet high and 493 feet long, a third at Keokuk, Iowa.

Volcanic agglomerates and basalts, as well as joints or irregular fractures in otherwise massive rocks, may also permit considerable leakage.⁵

To prevent leakage under the dam, the impervious portion of the latter is carried down to rock regarded as sound. In addition pressure grouting, by which a very thin portland cement mixture is forced down drill holes and from these into the cracks and pores of the rock, is often used.

In the case of gravel and sand, material which is permeable to start with, there may be an increase in permeability due to finer material being carried out to the downstream side of the dam, thus leaving cavities which are followed by settling and possible failure of the dam.

If the dam has to be located on unconsolidated pervious material

¹ Amer. Inst. Min. Met. Engrs., Tech. Pub. 215: 58, 1929.

² Eng. News, LXX: 949, 1913.

³ Christians, Eng. News-Rec., XCVI: 98, 1926.

⁴ See Wegenstein, Eng. News-Rec., XCIII: 128, 1924 (Spain); *Ibid.*, CXVI: 360, 1926 (Wash.); Gowen, Amer. Soc. Civ. Eng. Trans. XLIII: 468, 1900 (new Croton dam).

⁵ Rands, Amer. Soc. Civ. Eng., Trans. LXXVIII: 447, 1915 (Estacada dam, Oregon); Cole, Eng. News., LXIX: 647, 1913 (Lahontan dam, Nevada); Eng. Rec., LXXIII: 385, 1911 (Olive Bridge dam, New York).

“the impervious portion of the dam is carried upstream as a blanket and various cut-off structures are built into the pervious material so that the route of travel of water percolating under the dam shall be so long and so devious that friction will reduce the velocity of the water to a safe figure” (Bryan).

The ratio of the distance traveled by the water to the height of water behind the dam is called the *percolation factor*. It is said to range from 5 to 20 in successful dams, the former figure for gravel and the latter for quicksand.

The permeability of the entire cross-section of underlying material should be determined if possible.

Failures of dams due to seepage are not uncommon.¹

Joints and faults. — The jointed nature of a rock should not be overlooked. These joints, may be sealed with mineral matter, filled with clay, or be clean and open. They may also be variably spaced, and this feature, as well as their direction, should be recorded.

Faults crossing the valley are, in the opinion of some, not necessarily dangerous, unless they happen to be lines of fracture along which further movement may be expected (live faults). A zone of crushing, or a shear zone, however, may be particularly dangerous. It is just as well to avoid placing a dam on a fault line.²

Both joints and faults cause planes of weakness in the rocks and may also form seepage channels and permit upward pressure below the dam.

Uplift pressure. — Water pressure will be transmitted along joints or other openings under the dam, and if no free exit is present the upward pressure will equal that of the height of water in the reservoir. Pressure may be similarly transmitted through porous sand and gravel. In some cases it may be sufficient to cause failure of the dam and it is thought by some that a number of dam failures have been due to this cause.³

Scouring. — Water falling over a dam, or discharged through gates is often capable of active scouring, which may affect rocks that are perfectly capable of strong resistance to load or shearing. Thus at the dam at Keokuk, Iowa, although there was a concrete apron to protect the thin-bedded limestone below the toe, in less than a year much of it

¹ See Eng. News, LXVII: 900, 1912 (Mineville, N. Y.); McKay, *Ibid.*, LXV: 743, 1911 (Hauser Lake dam, Montana); *Ibid.*, LXXI: 211, 1914 (Stony River dam, W. Va.); Buckley, *Irrigation Works of India*, 157 *et seq.*, 290, 1905.

² Switzer, *Res. Tenn.*, II: 45, 1912 (Ocoee River, Parksville, Tenn.).

³ Terzaghi, *Amer. Inst. Min. Met. Engrs., Tech. Pub.* 215: 31, 1929; Eng. News. p. 366, 1912 (Ohio River dam).

had been torn loose and piled up.¹ Similar scouring and undermining has gone on at the Muscle Shoals dam.

Abutments. — Proper geologic conditions around the abutments are almost as essential as those under the dam. Matthes claims that “there are comparatively few high dams where leakage does not or did not at some time, take place around abutments, and while as a rule it is not dangerous, it is difficult to stop, and its psychological effect is bad.”

Abutments may be of either hard or soft rock. If the former and if joints or bedding planes permit leakage, these can often be grouted up, or in some cases may silt up. If the hard rock is limestone or gypsum there is danger of cracks becoming enlarged by solution. Basalt of course is very leaky, but the rock is not soluble.

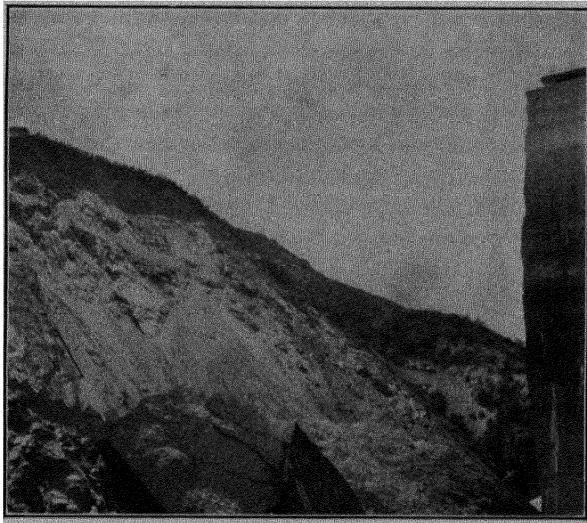

Fig. 196*h*. — Slide of schist on left, following break of St. Francis dam, California. (H. Ries, photo.)

Slate and schists with steeply dipping structural planes are liable to slide easily. At the time of the failure of the St. Francis dam the schist which formed one abutment slid badly, Fig. 196*h*.

Because the rock at abutments has been exposed to the weather, it may be more or less unsound, and hence all such material should be removed down to fresh, sound rock. Even during the work of construction there may be danger of its sliding.

Abutments in unconsolidated rocks also offer a serious problem, particularly if they are permeable and leakage occurs, since this may menace the security of the dam.¹ Careful examination should be made of the material, as regards its makeup and permeability. Clay is particularly bad because of its tendency to slide when wet. Where the unconsolidated rock of an abutment forms a narrow divide, it is less safe than if it were wide. A porous abutment may, however, sometimes be blanketed with clay.

In addition to considering the nature and structure of the materials composing the abutment, the groundwater level should also be determined in order to find its relation to that of the reservoir level.

A well known case of abutment failure is that of the Zuni dam, at Black Rock, N. Mex. This is a rock fill with earth blanket. The section in the canyon walls shows 30 feet of basalt, underlain by 40 feet of sand and clay, which in turn rests on 20 feet of blue clay that is below the stream grade. The lava caps the mesa on both sides of the canyon. A spillway 100 feet wide and 10 feet deep had been excavated in the basalt on the south abutment. The water soaked downward through the cracks in the basalt and carried away the fine sand under the rock. Slips occurred, the spillway was undermined, and a large section of the abutment and part of the dam slipped downstream.²

Spillways. — These are constructed to carry off excess water from the reservoir. They are therefore called upon to resist wear by running and falling water, hence should be lined with concrete as a measure of protection if the underlying rock is weak.

The massive sandstone at the Roosevelt dam spillway was eroded to such an extent by water falling nearly vertically from the mouths of the spillway tunnels as to require extensive repair. Bryan states that "at the Sherbourne Lakes dam in Montana a concrete spillway built over one of the abutments was destroyed by soil creep and landsliding of the shale hill above it. Here the damage was caused by too deep a cut in an unstable slope."³

Geologic investigation. — The geologic investigation of the dam site should include determination of form of rock channel, depth and character of filling in it; kind of bed rock; presence, character, direction

¹ See Henry, Amer. Soc. Civ. Eng., Trans. LXXIV: 38 and 87, 1911 (Cold Springs, Oregon and Conconully, Wash.); Beemer, Eng. News., LXII: 597, 1909 (Zuni dam, N. Mex.).

² Eng. News., LXII: 597, 1909.

³ U. S. Geol. Surv., Wat. Sup. Pap. 597: 26, 1929. See also Schuyler, Reservoirs for Irrigation, 2d ed. p. 226, 1908; Hill, Eng. News-Rec., LXXXIX: 798, 1922; Oram, *Ibid.*, XCVIII: 190, 1927.

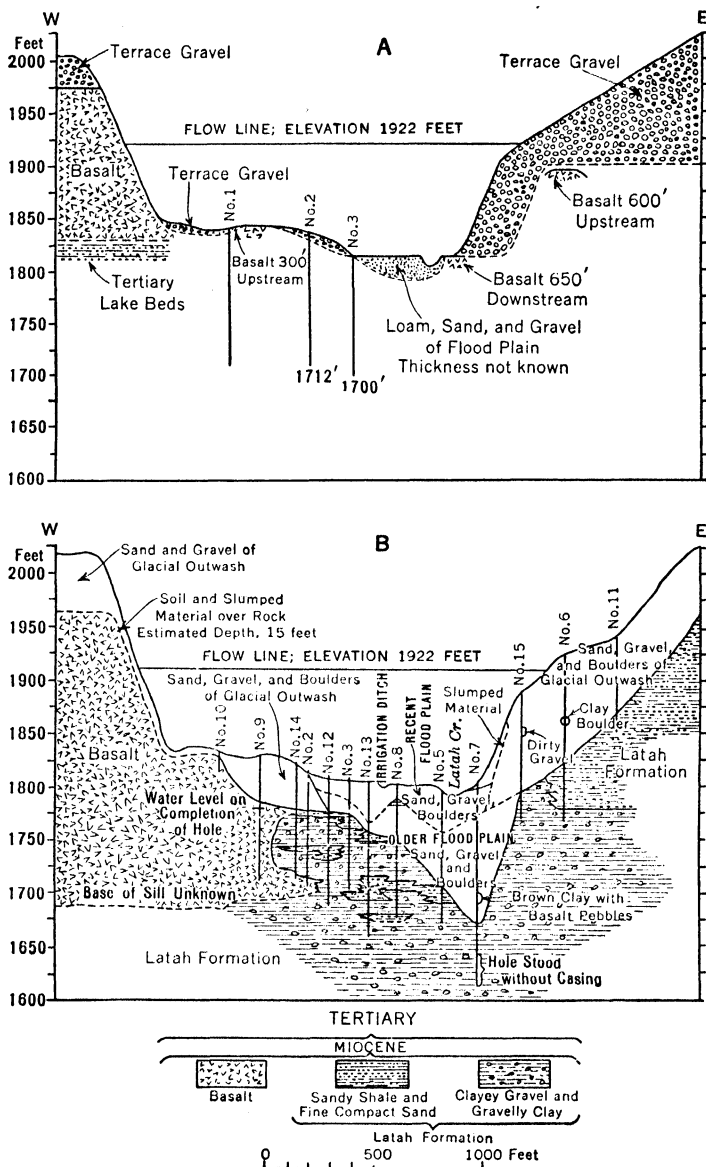

FIG. 196i. — Geologic section of Latah Creek dam site, Columbia basin irrigation project, Washington. *A*, showing known and inferred relations; *B*, based on completed examination and results of test drill holes. (After Bryan, U. S. Geol. Surv., Wat. Sup. Pap. 597-A, 1929.)

and spacing of joints, faults, shear zones; position of beds; depth of weathering in rock; permeability of material; ability of rock to withstand hydraulic and dynamic pressure.

Much information may have to be obtained from drill holes and these should be located with reference to the structure of the rocks, instead of placing them arbitrarily in straight rows. Shot drills are recommended for exploring bed rock conditions because they give large cores at least cost, and insure a substantial core recovery. They are also said to be very sensitive to the presence of joints or other openings in the rock. If, however, the groundwater level is to be determined, drilling must be suspended frequently and for a sufficiently long period to permit the water to sink to its normal level. Drill holes may also be used for pressure tests in order to locate leaky joints and cavities in the bed rock. Churn drills are often unsatisfactory for the reason that a boulder may be mistaken for bed rock. Sounding rods are also liable to lead to error, as a finely cemented gravel may be reported as bed rock.

In recent years electrical prospecting¹ has been used with much success to determine the depth of unconsolidated material overlying bed rock. Crosby claims that by the use of the electrical potential method the depth of glacial gravels over bed rock can be determined with an accuracy of about 5 per cent. This method of prospecting should be particularly valuable in glaciated areas where there is an almost complete lack of correspondence between bed rock and surface topography.

¹ Crosby and Leonardon Amer. Inst. Min. Met. Engrs., Tech. Pub. 131; Eng. News-Rec., Feb. 14, 1929; Jour. Bos. Soc. Civ. Engrs., Jan. 1929.

CHAPTER XII

BUILDING STONE

Properties of Building Stone

Under the term "building stone" are included: (1) All stone used for dimension blocks in the ordinary construction of buildings, dams, dry docks, retaining walls, etc.; (2) stone used for purposes of ornamentation; and (3) stone used for roofing. Stone employed for flagging and paving blocks belong more properly under the head of paving materials.

Kinds of rock used. — Many different kinds of rock are employed for building purposes, although the sedimentary ones, because of their wider distribution and lower cost of quarrying, are more extensively utilized than the igneous or metamorphic ones.

Moreover whatever the class of stone selected for building work, it is usually only the more massive and denser varieties that are chosen, although in some regions of mild climate very soft and porous rocks may occasionally be quarried. However, the choice of such should be made with great care.

Factors governing the selection of building stone. — The factors which govern the choice of a building stone are cost, color, and durability. The first of these is often given the greatest weight, the second forms the primary consideration when the stone is used for purely ornamental purposes, while the last is given altogether too little weight by many purchasers of structural materials.

Each of these factors may be considered in more detail.

Cost. The cost of a building stone will depend on: (1) Its availability, whether easy of access, close to transportation lines, or in abundance and purity; (2) its workability, whether easy to extract and dress; and (3) location. One of these may greatly overbalance the others.

Thus granites are found in several parts of the United States, but an engineer requiring a granite for use in the Southern states, may select the Maine product, not because granites of equally good quality are wanting in the South, but because the quarries of the New England states are often not only well equipped for quarrying and handling stone, but as a rule have the advantage of water transportation.

Color. — This factor is perhaps of more importance to the architect than the engineer, and yet the latter does not entirely neglect it, for in

engineering work a light-colored stone is preferred to a dark one, because of its brighter and cleaner appearance. Aside from this, however, lighter-colored stones of igneous character are more widely used, because their structure is usually such as to permit the extraction of larger blocks.

Beauty. — This factor is considered mainly in the selection of decorative stone, such as marble, serpentine, or onyx.

Durability. — Curiously enough, this property, which should be regarded as of primary importance in the selection of a building stone, is often relegated to last place. Many a costly structure stands as a mute witness to the neglect of this important property. The mere fact that a stone is hard and dense when quarried is no guarantee that it will endure the attacks of weathering agents for even a period of 25 years.

Structural features of building stone. — Under this head are included jointing, stratification, and cleavage. The discussion of these is of great practical importance since they affect the character of the rock, ease of quarrying, and indirectly the durability.

Joints. — No stone is free from joints. In stratified rocks they are usually vertical, and occur in one or more systems.

In igneous rocks they may be both vertical and horizontal, and show their best development in granites. In these the more pronounced of the vertical systems is termed the *rift*, and even if there is not a second system at right angles to the rift, the stone may have a grain along which it splits.

The horizontal jointing usually present in granite quarries tends to break the rock into a series of sheets, which are not of uniform thickness throughout, because the horizontal joints usually converge, thus breaking the granite into a series of flat lenses often of considerable horizontal dimensions.

Joints may be both an advantage and a disadvantage. Their presence is beneficial in that they facilitate the extraction of the stone, a matter of importance in a hard rock like granite.

They are injurious in some cases, because (1) they form a channel of access for the weathering agents, as a result of which the stone may be weathered for a distance of an inch or more on either side of the joint plane. (2) They limit the size of the blocks which can be extracted, and sometimes an otherwise good stone may be so cracked by joints as to be of little value for any purpose other than road material.

If the horizontal joints are closely spaced, but vertical joints widely separated, slabs of large size can be obtained, while if the horizontal joints are also far apart, stone having all three dimensions large, can be extracted.

As explained under weathering, crystalline rock like granite, which is commonly broken into blocks by three sets of joint planes, may undergo decay on all sides of the blocks, so that if the process proceeds far enough the upper part of the quarry shows a series of boulders of fresh rock, surrounded by residual clay. In such event it may be necessary to strip off 15 or 25 feet before reaching sound stone.

Quarries in which the stone is broken into blocks, often of irregular size and shape, by jointing, are known as boulder quarries (Plate LXIV, Fig. 2).

Stratification. — The planes of stratification present in all quarries of sedimentary rock exert an influence similar to joints. They facilitate the extraction of the stone but, if too closely spaced, may make the stone so slabby that it is of no use except for flagging purposes. They also afford more ready channels of access for surface waters, especially if tilted, and thus cause the stone to weather.

Inclined beds may call for a different plan of quarrying than horizontal ones, the floor of the quarry being worked on a slant, parallel with the bedding, instead of flat (Ref. 1, 1a).

Durability of Building Stone

The processes of weathering have been described in another chapter and need not be repeated here. The durability of a building stone depends on its ability to successfully resist the attacks of weathering agents, and the natural factors affecting this are structure, texture, and mineral composition. Location in building may be regarded as an artificial factor.

Structure. — Any structural weakness facilitates the operation of the weathering agents. Thus joint planes, bedding planes, fault planes, or irregular fractures produced by folding or faulting (in other words, cracks of brecciation) all serve as pathways for weathering agents (Plate LX, Fig. 1). Into these the surface waters, frost and plant roots can enter, and if the stone is susceptible bring about its disintegration and decomposition, or decay.

Texture. — A stone may be either coarse or fine (Plate LXII) and even-grained (Plate LXII, Fig. 1), or it may be porphyritic (Plate IV, Fig. 2). It may also be dense or porous.

Considering the texture first, we find that stones tend to disintegrate somewhat under changes of temperature, and that coarse-grained rocks are affected more than fine-grained ones, while those of porphyritic texture, especially if coarse-grained, are disintegrated more rapidly than the finely-grained porphyritic and even granular ones.

This disintegration is due in part at least to the different coefficients of expansion of the individual minerals.

A dense stone, other things being equal, will break down less rapidly than a porous one, for the following reasons. Dense rocks are practically impervious, hence the weathering agents cannot work their way into them. Porous rocks, being open, absorb water readily, and if this absorbed water freezes in the pores of the stone, it may split the latter.

Mineral composition. — Since different minerals show a different degree of resistance to the attacks of weathering agents, it follows that the rocks, because of their varying mineral composition, will also vary in their weather-resisting qualities, and that those containing the most susceptible minerals will suffer first on exposure to the elements. The somewhat rapid breaking down of rocks with an abundance of pyrite, or marbles with much mica, frequently serve as a warning that all stones will not endure forever. (See further in Chapter on Weathering.)

Life of a building stone. — The life of a building stone refers to the period of time that it will resist the attacks of weathering agents without undergoing disintegration or decay. It may be influenced by natural or artificial causes. The former include quarry water and injurious minerals; the latter, selection, quarrying and its position in the structure.

Quarry water. — Many stones, especially stratified ones, contain water in their pores when first quarried. This is known as quarry water, and may be present in some stratified rocks, such as sandstones, in sufficient quantities to interfere with quarrying during freezing weather.

The quarry water usually contains mineral matter in solution, and when the liquid evaporates, as the stone dries out, the former is left deposited between the grains, often in sufficient quantities to perceptibly harden the rock.

Estimated life of building stone. — The following table was compiled some years ago by A. A. Julien, and is based in part on observations made on building stone in New York City.

Kind of stone.	Life in years.
Coarse brownstone.....	5 to 15
Fine laminated brownstone.....	20 to 50
Compact brownstone.....	100 to 200
Bluestone (sandstone), untried, perhaps centuries.....
Coarse fossiliferous limestone.....	20 to 40
Fine oolitic (French) limestone.....	30 to 40
Marble, coarse, dolomitic.....	40
Marble, fine, dolomitic.....	60 to 80
Marble, fine.....	50 to 100
Granite.....	75 to 200
Gneiss, 50 years to many centuries.....

To the above might be added many serpentines and cippolino marble, which in a severe climate sometimes do not have a life of more than 2 or 3 years.

Injurious Minerals

Certain minerals are to be regarded as injurious under all circumstances, while others such as mica can be considered so only when occurring in abundance in some rocks, such as sandstones and marbles. The effect of these may be as follows:

Flint or chert. — This term, as already explained, refers to the amorphous or non-crystalline forms of silica (see under Quartz, Chapter I), which forms concretions in many limestones (Plate XIII, Fig. 2). There are several objections to the presence of this material.

Firstly, it is much harder than the surrounding rock, and therefore, interferes with the cutting of it. Secondly, it is more resistant to weather, and as a result stands out in knotty relief on the weathered surface of the stone. Thirdly, the rock when exposed to weather is likely to split along the lines of chert concretions. Cases are known of bridge abutments constructed of cherty limestone, which split so badly that they had to be torn down and replaced.

Mica. — This is a common constituent of many granites, gneisses, sandstones, and marbles. It is not harmful in the first, unless segregated into bunches or knots, in which case it renders the stone unsightly. In the second it seldom causes trouble, unless it becomes so abundant as to develop a schistose structure, thus interfering with the use of the stone for dimension blocks. In the third it does no harm if present in small quantities, and is uniformly distributed through the rock; but if it is abundant and segregated along the stratification planes, splitting of the stone on continued exposure to frost is likely to result. The trouble has been sometimes aggravated, as in the case of the Connecticut brownstone, by setting the stone on edge, thus permitting the layers to flake off. Many a brownstone front in the cities of the eastern United States has scaled so badly after 15 or 20 years exposure, as to require the whole front of a building to be repointed with hammer and chisel.

Mica is also an objectionable impurity in many crystalline limestones or marbles. In these it may be present in scattered grains, blotches or bands.

The scattered grains if few are not likely to cause much trouble, but in the other two cases, the mica not only interferes with the continuity of the polish, but often succumbs to the attacks of weathering agents to such an extent, that the stone becomes badly pitted or even spalls off.



PLATE LIX, FIG. 1. — Weathered sandstone, second story, County Court House, Denver, Colo. (R. D. George, photo.)

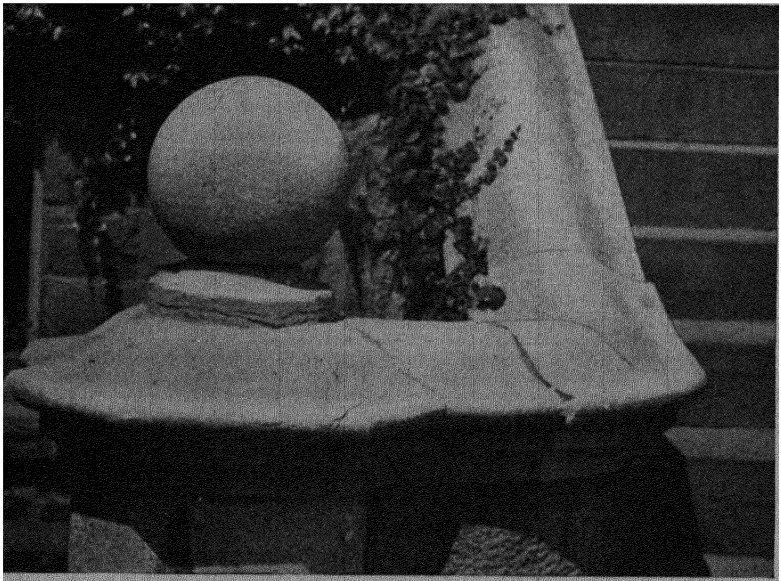

FIG. 2. — Roughened surface of limestone after some years of exposure to weather. (H. Ries, photo.)

In some marbles which are exposed to the weather in a severe climate this trouble is likely to appear within two or three years after the stone is placed in the building.

Pyrite.¹ — Many building stones contain at least small quantities of this mineral, which on exposure to weather changes through oxidation and hydration to limonite.

A few small specks scattered here and there through the rock do little or no harm. In abundance, or if in large lumps, the change of pyrite to limonite, develops pits in the stone, and moreover the limonite set free is often washed down over the surface of the rock causing an unsightly stain. Again, in the decomposition of pyrite, some sulphuric acid is formed, and if the rock contains carbonates these are attacked by the acid set free.

When the pyrite changes to iron sulphate, the latter being easily soluble is brought to the **surface** by evaporating moisture, and deposited there as a whitish scum. All "whitewash" is not, however, attributable to this cause.

In some stones, as for example, the Berea sandstone, the pyrite appears to be in a very finely-divided condition, and evenly distributed through the rock. In this case the pyrite does not exercise any injurious influence, but simply causes a change of color, the stone taking on a buff tint as the pyrite alters to limonite.

It must not be understood from the above that all discoloration in building stone is due to pyrite, for it is not. Take for instance the case of a building stone in which iron is present in the form of ferrous carbonate. This will also change to limonite on exposure to weather.

In general we can say, that a stone containing an appreciable quantity of pyrite is to be avoided.

Tremolite. — This is a white to pale-green variety of amphibole (see Chapter I), found in some magnesian, crystalline limestones. It occurs in blade-like or silky-looking masses, and on exposure to weather tends to decompose to a greenish-yellow clay. This washes out leaving pits on the surface of the stone. Tremolite is found in some crystalline limestones in pieces varying from a fraction of an inch in diameter to patches several inches across. It is not found in the stone of all quarries, and even in those which do contain it, all parts of the mass do not show it. The product of a given quarry might, therefore, at one time run high in tremolite, and at another be quite free from it.

Prolongation of life of building stone. — Much building stone is lost due to careless quarrying. The use of too much explosive, or im-

¹ This includes also marcasite and pyrrhotite.

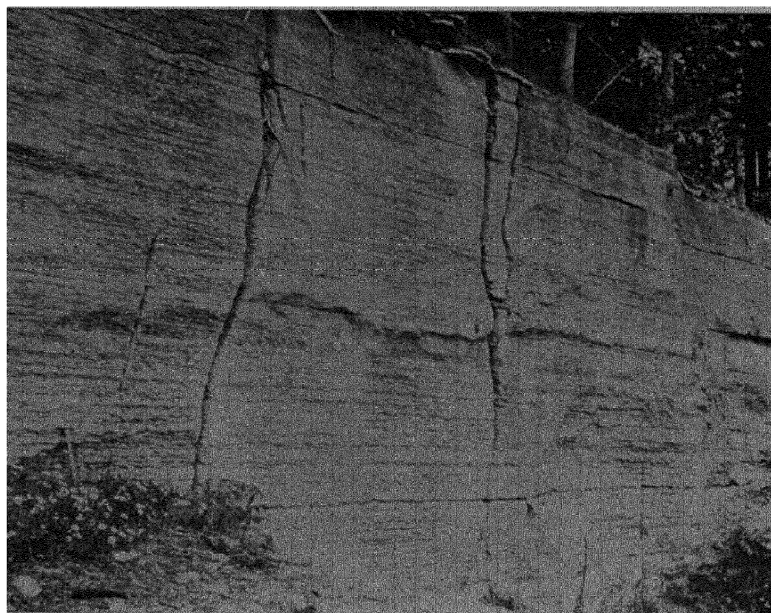

PLATE LX, FIG. 1. — View in a limestone quarry showing solvent action of water along joint planes. (H. Ries, photo.)

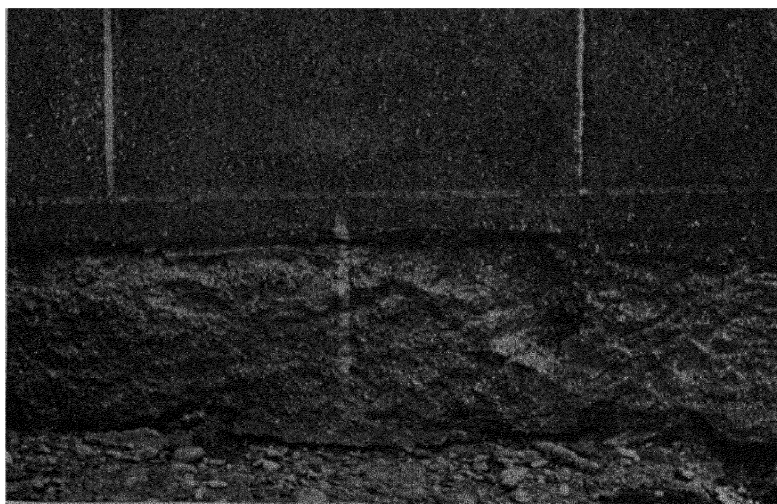

FIG. 2. — Deterioration of lava rock at St. George, Utah, caused by soluble sulphates absorbed from soil. (R. A. Hart, photo.)

proper placing of drill holes may cause shattering of the stone and development of minute cracks. Although the latter are often too small to be noticeable to the naked eye, still the frost and other agents of weathering will work their way into them and ultimately injure the stone. A considerable quantity of building stone, especially limestone and sandstone, is now quarried with channeling machines thus avoiding the use of explosives.

Improper selection often has much to do with the life of a stone, and all stock should be carefully examined before it is accepted.

Stratified rocks should be set on bed and not on edge.

Rocks of a highly absorbent character should be either set in a dry position, or else coated with some waterproofing material. Moreover very porous stones should not be used in a cold moist climate.

The weather conditions of the middle and northern Atlantic states, with their frequent extreme changes of temperature in winter, are especially severe on many building stones.

Even the careless dressing of the surface of a building stone, may open up minute crevices into which weathering agents work their way quietly, but persistently.

Physical Properties

Absorption. — The absorption of a building stone refers to the quantity of water which it will absorb, and is usually expressed in percentage terms of the original dry weight. It shows wide extremes even in the same kind of rock, but in general it is very low in igneous rocks (excepting certain volcanic ones) and metamorphic rocks. Limestones and sandstones show variation, but in general absorption is low in those used for building purposes. Figures indicating the range of absorption of the different kinds of stones are given under their respective heads.

HIRSCHWALD'S ABSORPTION TESTS

	Percentage by weight.				Percentage of pore volume.			
	I.	II.	III.	IV.	Ia.	IIa.	IIIa.	S.
Sandstone	4.89	5.66	7.89	9.23	52.97	61.30	85.46	0.613
Sandstone	6.90	7.33	10.80	11.31	61.06	64.88	95.48	0.648
Marble	0.35	0.49	0.55	0.59	59.47	84.27	94.67	0.831
Limestone	7.51	7.88	19.08	21.19	35.46	37.20	90.04	0.372
Slate	0.51	0.55	0.70	0.70	72.92	79.16	100.00	0.786
Tuff	22.11	23.41	30.25	33.75	65.51	69.37	89.64	0.694
Granite	0.51	0.91	1.07	1.25	41.20	57.71	85.54	0.728

I. Absorption after rapid submersion; II. absorption after slow submersion; III. submersion under vacuum; IV. submersion under 50 to 150 atmospheres pressure. Ia-IIIa represent the percentage of the pore volume filled by the water in each case. S is the saturation coefficient and = $\frac{II}{IV}$.

The experiments of Hirschwald (Ref. 4) have shown that a stone absorbs considerably more water in a vacuum or under strong pressure than it does under normal atmospheric pressure.

Relation of absorption to porosity. — There is not necessarily any fixed relation between absorption and porosity. The latter represents the volume of pore space and hence a stone of low porosity can absorb but little water, while a stone of high porosity may absorb and hold a large quantity of water. The latter, however, will depend somewhat on the size of the pores. If these are small, the water is drawn in by capillarity and held; but if the pores are large, the water will drain off more readily if circumstances permit.

It is probable that a very porous stone will not absorb enough water under normal conditions to completely fill its pores, and for this reason chiefly a determination of the porosity of a stone does not seem of great practical importance, except in special cases.

These would include the exposure of the stone to very moist conditions, or its use in the lining of water-carrying tunnels, where the water may be under considerable pressure.

The following determinations of porosity are given by Foerster.¹

	Per cent		Per cent
Granite.....	0.04 to 0.61	Trachyte tuff.....	25.07
Sycnite.....	1.38	Serpentine.....	0.56
Diorite.....	.25	Sandstones.....	6.9 to 25.5
Porphyry.....	0.29 to 2.75	Carrara marble.....	0.22
Basalt.....	1.28	Calcareous tufa.....	32.2
Diabase breccia.....	0.18	Roofing slates.....	0.45 to 0.115

Buckley's² work on Wisconsin building stone gives:

	Per cent
Granites.....	0.019 to 0.62
Limestones.....	0.55 to 13.35
Sandstones.....	4.81 to 28.28

and for Missouri stone³ he gives:

	Per cent
Granites.....	0.255 to 1.452
Limestones.....	0.32 to 13.38
Sandstones.....	7.01 to 23.77

The porosity can be obtained by the formula:

$$P = 100 \frac{W - D}{W - S},$$

¹ Baumaterialenkunde, I, p. 13.

² Wis. Geol. & Nat. Hist. Survey, Bull. IV, p. 400, 1898.

³ Mo. Bur. Geol. & Mines, II, 2nd series, p. 317, 1904.

in which

P = per cent porosity.

W = saturated weight.

D = dry weight.

S = suspended weight of saturated stone.

Character of pores. — It has already been pointed out that the pores of a rock may be either large or small. To this should be added that they may be comparatively straight or tortuous, and of varying diameter. The practical significance of these two points is that in a stone with straight pores the water in expanding as it freezes may squeeze out, and thus exert less internal pressure on the stone, but if the pores are winding, the reverse is true, and the stone is subjected to greater pressure from inside. The same is true if the pores are constricted at points, for the water finds difficulty in squeezing through them.

Amount of water absorbed under different conditions. — There is some question as to whether the quantity of water absorbed in the laboratory test is not greater than that absorbed when the stone is in use.

In the former case the stone is submerged in water, and encouraged to soak up as much as possible, indeed, some suggest placing the submerged stone under a vacuum, which would still further increase the amount of water absorbed.

In use the stone is set in the wall with one or at most two sides exposed to the rain, and it is questionable whether the stone would, when so exposed, take up as much water as when surrounded by water on all sides. Of course if the stone is set in damp soil, or is exposed to water under pressure it might take up more.

It is also true that a stone set in a cornice, or water table, or on a flat surface will hold water or snow longer than if placed in the face of a vertical wall.

Crushing strength. — The crushing strength of a stone refers to its resistance to pressure. Unfortunately it is a property to which undue importance has been attached; indeed, in some cases it may be the only test made on a stone. It can be safely assumed, as has been claimed by some that a stone which “is so weak as to be likely to crush in the walls of a building, or even in a window stool, cap or pillar, bears such visible marks of its unfitness as to deceive no one with more than an extremely rudimentary knowledge on the subject.”

Few stones used for building purposes will, when tested, show a strength under 6000 pounds per square inch, and many, especially igneous ones, range as high as 20,000 to 30,000 pounds per square inch, and in extreme cases 40,000 pounds.

To be sure, in some large buildings a single column or block may be called upon to carry a heavy load, but even then it probably does not approach the limit of strength of the stone.

Buckley has shown that the stone at the base of the Washington monument supports a maximum pressure of 22,658 tons per square foot, or 314.6 pounds per square inch. Allowing a factor of safety of twenty would only require the stone at the base of the monument to sustain 6292 pounds per square inch. Even at the base of the tallest buildings the pressure is probably not more than 160 pounds per square inch.

The crushing strength of a stone is commonly obtained by breaking a cube (usually 2 in.) in a special testing machine. Great care should be taken to see that the cubes are prepared with the sides smooth and exactly parallel. In some cases, instead of preparing the surface of the cube carefully, it is only made approximately smooth and bedded between the plates of the machine with pasteboard or plaster of Paris.

In order to accurately compare the crushing strength of different building stones, the conditions under which the tests are made should be alike in every case. The importance of this is clearly recognizable if we stop for a moment to consider the factors that may affect the result. These may be: (1) Method of quarrying, whether by channeling machine or explosive; (2) length of time of seasoning; (3) method of preparing cubes for test; (4) degree of dryness of stone; (5) temperature of test piece; (6) direction of application of pressure, with respect to bedding planes, cleavage, grain, etc.; (7) character of bearing faces of machine; (8) material interposed between bearing plates of machine and face of cube.

These emphasize the fact that the crushing test should be standardized, and all tests made in accordance with this standard.

Other things being equal, the crushing strength of a stone is dependent on the state of aggregation of the mineral particles.

In stratified rocks it depends on the character and amount of the cementing material, while in igneous and metamorphic rocks it is dependent on the interlocking of the mineral grains (Plate VII). This interknitting of the minerals produces a higher average crushing strength in the two last-named classes of rocks.

A large number of crushing tests of building stones have been published (see especially Refs. 6, 43, and 78), but those made by different persons are not always comparable with safety for the reason that the tests have not always been carried out in exactly the same manner.

The following figures from tests by Buckley for Missouri and Wisconsin, Marston for Iowa, and Parks for Ontario, will give some idea of the variations which exist in the different groups of stones.

State or Province.	Kind.	Range, lbs. per sq. in.
Missouri.....	Limestone.....	5,714 to 27,183 on bed
".....	Limestone.....	5,774 to 25,577 on edge
".....	Sandstone.....	4,371 to 9,002 on bed
".....	Sandstone.....	3,933 to 9,206 on edge
".....	Granite.....	18,236 to 19,410
Wisconsin.....	Igneous rocks.....	15,009 to 47,674
".....	Limestone.....	6,675 to 42,787 on bed
".....	Limestone.....	7,508 to 40,453 on edge
".....	Sandstone.....	4,340 to 13,669 on bed
".....	Sandstone.....	1,763 to 12,566 on edge
Iowa.....	Limestone.....	2,470 to 16,435
".....	Sandstone.....	3,600 to 13,000
Ontario ¹	Sandstone.....	9,539 to 31,793
".....	Granites and gneisses.....	23,152 to 33,453
".....	Crystalline limestone and marbles.....	12,079 to 25,018

¹ Report on Ontario Building Stones by Parks, Dept. of Mines, Can., 1912.

Relative strength on bed and on edge. — The statement is made by some writers that bedded or laminated stones will stand a greater pressure in a direction at right angles to their bedding than parallel with it. This seems theoretically correct, but the published tests do not always appear to confirm it.

The following data taken from the work of Buckley on Missouri and Wisconsin building stones indicate no general law.

Kind.	Locality.	Bed.	Edge.
Limestone.....	Bowling Green, Mo.....	8,881	6,019
".....	Breckenridge, Mo.....	6,944	8,036
".....	Carthage, Mo.....	14,271	11,879
".....	".....	16,337	15,396
".....	".....	12,741	12,684
".....	Hannibal, Mo.....	9,286	9,915
".....	Kansas, City, Mo.....	13,124	10,449
Sandstone.....	4,942	4,143
Sandstone.....	Warrensburg, Mo.....	5,911	4,869
Limestone.....	Wauwatosa, Wis.....	10,111	13,406
Limestone.....	Wauwatosa, Wis.....	17,647	23,744
Sandstone.....	Ashland, Wis.....	6,244	4,747
Sandstone.....	Dunnville, Wis.....	2,502	2,944

Relative strength wet and dry. — A building stone should always be tested dry, for the reason that it shows a lower strength when wet.

There are, unfortunately, few published tests to show this, but the following figures given by Watson, Laney and Merrill in their report on North Carolina building stones (Ref. 51) emphasize the difference to a marked degree.

CRUSHING TESTS OF NORTH CAROLINA SANDSTONES

Per cent absorption.	Conditions.	Crushing strength, lbs. per sq. in.
4.2.....	Dry.....	10,322
	Wet.....	11,150
3.71.....	Wet.....	6,962
	Dry.....	5,837
	Wet.....	12,250
	Dry.....	11,232
	Wet.....	5,637
		6,712

The greatest decrease of strength on soaking is likely to be shown by those stones whose cement is liable to soften when they are soaked in water.

Effect of intermittent pressure. — Stones usually weaken when subjected to continued or intermittent pressure, and may fall considerably below their normal ultimate crushing strength. However, great difficulty is experienced in obtaining satisfactory data on this point, for the reason that it is difficult to tell within a range of 1000 to 5000 pounds, the crushing strength of samples to be tested (Buckley, Ref. 43).

Effect of freezing on crushing strength. — It is quite evident that a stone which is saturated with water and then subjected to repeated freezings for 20 or more times may be weakened to such an extent that it will not withstand the same pressure as a cube of fresh stone.

Buckley found that out of thirty-four sets of samples of Missouri stones tested, only eleven gave an average crushing strength higher than that of the fresh samples. The greatest loss does not appear in those showing the highest porosity as can be seen from the following table:

CRUSHING TESTS ON FRESH AND FROZEN SAMPLES OF MISSOURI STONES

Kind.	Locality.	Per cent porosity.	Average crushing strength, fresh.	Average crushing strength after freezing.
Limestone.....	Bowling Green.....	10.62	8,881 6	11,074.0
".....	Breckenridge.....	7 90	6,944 0	8,163.0
".....	Carthage.....	1.34	14,270.6	13,382 7
".....	Columbia.....	3.10	9,828 5	9,738.0
".....	Hannibal.....	5.03	9,286 3	8,975.0
".....	Joplin.....	1.13	11,870 0	8,111.0
".....	Rolla.....	13.00	8,486.7	9,323 3
".....	St. Louis.....	7 30	17,095.0	16,246.0
Sandstone.....	Curless.....	22.95	4,942 0	5,742.0
".....	Miami.....	14.31	7,477.6	8,670.5
".....	Warrensburg.....	16.77	5,910.6	5,097.0

CRUSHING STRENGTH OF WISCONSIN STONES BEFORE AND AFTER FREEZING

Kind of rock.	Location.	Crushing strength, fresh.	Crushing strength, frozen.
Granite.....	Athelstane.....	19,988	10,619
“.....	Berlin.....	24,800	36,009
“.....	Montello.....	38,244	35,045
Limestone.....	Duck Creek.....	24,522	28,392
“.....	Sturgeon Bay.....	35,970	20,777
“.....	Wauwatosa.....	18,477	25,779
“.....	Burlington.....	12,827	7,554
Sandstone.....	Presque Isle.....	5,495	5,930
“.....	Dunville.....	2,722	3,464
“.....	Port Wing.....	5,329	4,399

Hirschwald (Ref. 4) states that in order to determine the effect of freezing on the crushing strength, the crushing test should always be made on the wet stone.

Transverse strength. — The transverse strength of a stone may be defined as its ability to withstand a bending strain, and as numerically



FIG. 197. — Sandstone broken by transverse strain, caused by settling of the building.

expressed represents the force required to break a bar 1 inch square resting on supports 1 inch apart, the load being applied in the middle.

This is measured in terms of the *modulus of rupture*, which is computed from the formula:

$$R = \frac{3wl}{2bd^2},$$

in which

- R = modulus of rupture.
- w = weight required to break stone.
- l = distance between supports.
- b = width of stone.
- d = thickness of stone.

The importance of this test is not universally recognized, and it is, therefore, rarely carried out. Many a stone used for a window sill or cap has cracked under transverse strain because its modulus of rupture in the section used is too low. Such transverse breaks are not uncommonly caused by the settling of a building (Fig. 197.)

It must be remembered that the transverse strength does not appear to stand in any direct relation to the crushing strength.

While there is considerable variation in the modulus of rupture shown by different stones of the same class, the same kind of rock will usually show a lower transverse strength when wet than when dry, and also after exposure to hot and cold water baths.

Figures bearing out these statements are given below:

RANGE OF TRANSVERSE STRENGTH OF WISCONSIN AND MISSOURI BUILDING STONES (AFTER BUCKLEY)

Kind.	Modulus of rupture.	
	Wisconsin.	Missouri.
Granite	2,324.3 to 3,909.7	851.30 to 3,311.60
Limestone.	1,164.3 to 4,659.2	418.61 to 1,321.76
Sandstone.	362.9 to 1,324.0	

MODULUS OF RUPTURE OF ONTARIO STONES (AFTER PARKS)

Kind.	No. tested.	Range.	Average.
Limestones	33	818 to 4,291	2,224
Sandstones	10	417 to 2,186	1,283
Crystalline limestone	8	1,091 to 3,737	1,907
Granites	3	2,480 to 3,382

RELATIVE TRANSVERSE STRENGTH OF STONES IN NATURAL STATE, AND AFTER
EXPOSURE TO HOT AND COLD WATER BATHS. ¹

Granites

Description.	Modulus of rupture per sq. in.			
	Natural state, total.	After exposure to hot and cold water baths.		
		Total.	Loss.	Per cent of natural state.
	Lbs.	Lbs.	Lbs.	
From Braddock quarries, near Little Rock, Ark.	1704	1244	460
From Millbridge, Me., "White Rock Mountain"	2069	2027	42
From Rockville, Stearnes County, Minn.	1423	1230	193
Drake's granite, from Sioux Falls, Minn.	1378	1053	325
From Branford, Conn.	1415	1083	332
From Troy, N. H.	2335	2002	333
Means	1721	1440	281	83.7

Marbles

Rutland white, Vt. ^a	1202	291	911
Mountain Dark, Vt.	2109	1408	701
Sutherland Falls, Vt.	3054	1531	1523
From St. Joe, Ark.	1615	567	1048
From De Kalb, St. Lawrence Co., N.Y.	1144	533	611
From Kennesaw quarry, Tate, Ga.	1553	605	948
Means	1779	822	957	46.2

a. Heated in hot-air oven to 402° F.

Limestones

From Isle La Motte, Vt.	2493	786	1707
From Mount Vernon, Ky.	1434	1076	358
From Beaver, Carroll County, Ark.	2860	2247	613
From Bowling Green, Ky.	1317	799	518
Blue colored from Bedford, Ind.	1867	958	909
Means	1994	1173	821	58.8

¹Report on Tests of Metals, etc., 1895, War Department.

RELATIVE TRANSVERSE STRENGTH OF STONES IN NATURAL STATE, AND AFTER EXPOSURE TO HOT AND COLD WATER BATHS. — (Continued)

Sandstones

From Cromwell, Conn.....	2243	1500	743
From Worcester quarry, East Long Meadow, Mass.....	987	189	-202
From Kibble quarry, East Long Meadow, Mass.....	1273	655	618
From Cabin Creek, Johnson County, Ark.	2442	890	1552
Quarries near Fort Smith, Ark.....	1761	1185	576
From Olympia, Wash.....	2073	2297	-224
From Chuckanut, Wash.....	2016	961	1055
From Tenino, Wash.....	667	323	344
Means.....	1683	1125	558	66.9
Means of all stones.....				65.1

Fire resistance (Refs. 5, 7). — Many building stones suffer serious disintegration as a result of exposure to fire, or still worse the combined action of fire and water, and the serious conflagrations in such cities as Baltimore, San Francisco, etc., have demonstrated this fact.

This disintegration by fire may be due to unequal stresses set up within the stone by the outer portion of a block becoming highly heated

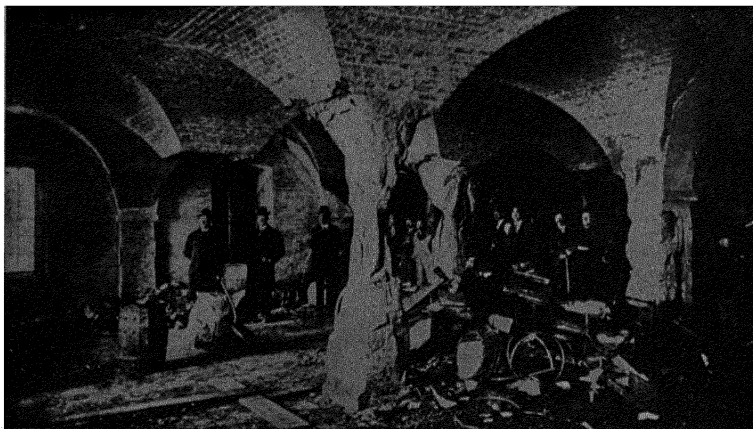

FIG. 198.—Effect of fire on granite columns, U. S. Public Storehouse, Baltimore, Md.

while the interior is still comparatively cool, or it may be caused by the stone first becoming highly heated, and then being suddenly cooled by the application of a stream of cold water.¹

¹ Some believe that the crumbling of granite under heat is due to microscopic bubbles in the quartz grains, which contain water or liquid carbonic acid gas. Under heat these hundreds of microscopic bubbles expand and burst.

The best form of test to determine the fire resistance of a building stone consists of building up a section of masonry of the stone to be heated, or the stone can be built up in an iron framework which forms one movable wall of a furnace. In either case the stone after being heated to about 1750° F., is cooled down by a strong stream of cold water from a hose.

Many stones after heating to redness and slow cooling emit a dull sound when struck. Lime rocks, if heated above 850° C. calcine to quicklime, but at a lower temperature they are less affected by heating and slow cooling than any other rocks. Granites seem on the whole to have a lower resistance than sandstones.

Considered as a class, however, building stones are of low fire resistance, especially if rapidly cooled. In comparative tests they are often found inferior to clay products of non-vitrified character.

A series of tests made by W. E. McCourt consisted in: (1) Heating two cubes to 550° C. and cooling one fast, the other slow; (2) similar treatment of two other cubes at 850° C.; (3) heating for five minute intervals in a strong blast and cooling for alternate five minutes; (4) alternately heating in a blast for five minutes and quenching with water for five minutes.

Professor McCourt in summarizing his New York tests made the following interesting statements:

“At 550° C. (1022 F.) most of the stones stood up very well. The temperature does not seem to have been high enough to cause much rupturing of the samples, either upon slow or fast cooling. The sandstones, limestones, marble and gneiss were slightly injured, while the granites seem to have suffered least.”

“The temperature of a severe conflagration would probably be higher than 550° C. but there would be buildings outside of the direct action of the fire which might not be subjected to this degree of heat and in this zone the stones would suffer little injury. The sandstones might crack somewhat; but, as the cracking seems to be almost entirely along the bed, the stability of the structure would not be endangered, provided the stone had been properly set.”

“The gneiss would fail badly, especially if it were coarse-grained and much banded. The coarse-grained granites might suffer to some extent. These, though cracked to a less extent than the sandstones, would suffer more damage and possibly disintegrate if the heat were long-continued because the irregular cracks, intensified by the crushing and shearing forces on the stone incident to its position in the structure, would tend to break it down. The limestones and marble would be little injured.”

“The temperature of 850° C. (1562° F.) represents fairly the probable degree of heat reached in a conflagration, though undoubtedly it exceeds that in some cases. At this temperature we find that the stones behave somewhat differently than at the lower temperature. All the cubes tested were injured to some degree, but among themselves they vary widely in the extent of the damage.”

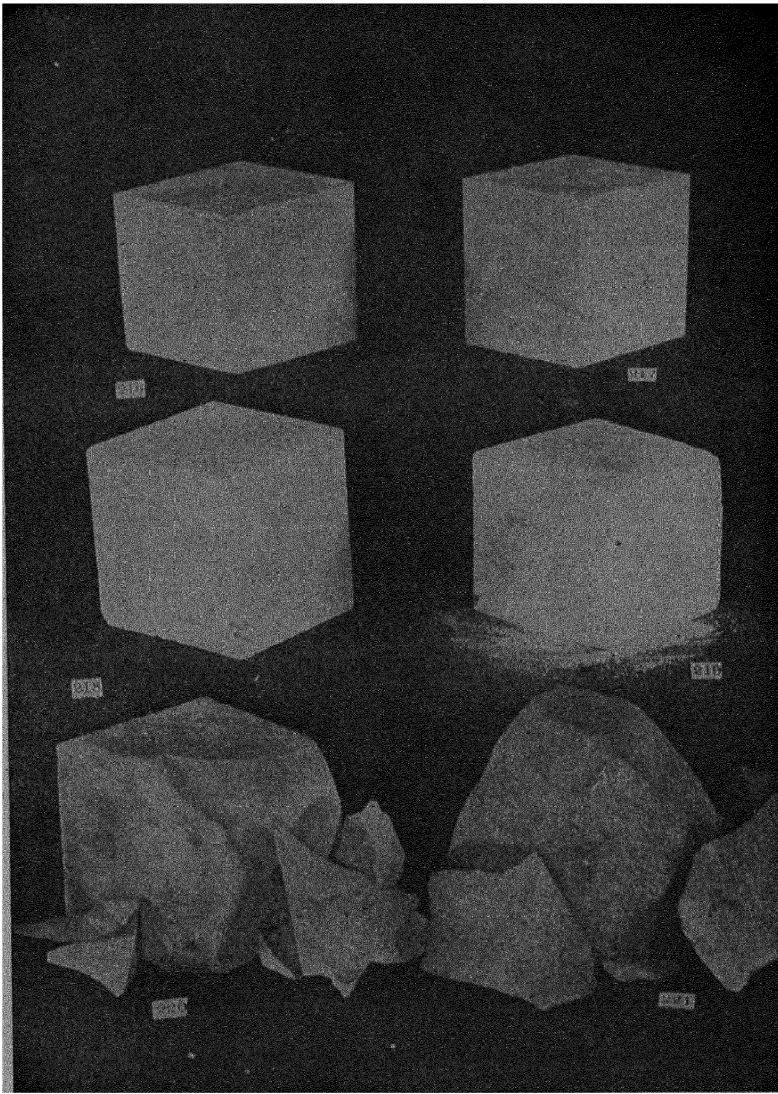

PLATE LXI. — Fire Tests on 3-inch cubes of limestone, Newton, N. J. (After W. E. McCourt.)

- | | |
|-----------------------------|-----------------------------|
| 216. 550° C., slow cooling. | 217. 550° C., fast cooling. |
| 218. 850° C., slow cooling. | 219. 850° C., fast cooling. |
| 220. Flame test. | 221. Flame and water test. |

“ All the igneous rocks and the gneiss at 850° C. suffered injury in varying degrees and in various ways. The coarse-grained granites were damaged the most by cracking very irregularly around the individual mineral constituents. Naturally, such cracking of the stone in a building might cause the walls to crumble. The cracking is due, possibly, to the coarseness of texture and the differences in coefficient of expansion of the various mineral constituents. Some minerals expand more than others and the strains occasioned thereby will tend to rupture the stones more than if the mineral composition is simpler. The rupturing will be greater, too, if the rock be coarser in texture. For example, a granite containing much plagioclase would be more apt to break into pieces than one with little plagioclase for the reason that this mineral expands in one direction and contracts in another, and this would set up stresses of greater proportion than would be occasioned in a stone containing little of this mineral. In the gneisses the injury seems to be controlled by the same factors as in the granites, but there comes in here the added factor of banding. Those which are made up of many bands would be damaged more severely than those in which the banding is slight.”

“ All the sandstones which were tested are fine-grained and rather compact. All suffered some injury, though, in most cases, the cracking was along the lamination planes. In some cubes, however, transverse cracks were also developed.”

“ The variety of samples was not great enough to warrant any conclusive evidence toward a determination of the controlling factors. It would seem, however, that the more compact and hard the stone is the better will it resist extreme heat. The following relation of the percentage of absorption to the effect of the heat is interesting. In a general way the greater the absorption, the greater the effect of the heat. A very porous sandstone will be reduced to sand and a stone in which the cement is largely limonite or clay will suffer more than one held together by silica or lime carbonate.”

“ The limestones, up to the point where calcination begins (600°–800° C.) were little injured, but above that point they failed badly, owing to the crumbling caused by the flaking of the quicklime. The purer the stone, the more will it crumble. The marble behaves similarly to the limestone; but, because of the coarseness of the texture, also cracks considerably. As has been mentioned before, both the limestones and marble on sudden cooling seem to flake off less than on slow cooling.”

“ The flame tests cannot be considered as indicative of the probable effect of a conflagration upon the general body of the stone in a building, but rather as an indication of the effect upon projecting cornices, lintels, pillars, carving and all thin edges of stonework. All the stones were damaged to some extent. The limestones were, as a whole, comparatively little injured, while the marble was badly damaged. The tendency seems to be for the stone to split off in shells around the point where the greatest heat strikes the stone. The temperature of the flame probably did not exceed 700° C., so it is safe to say that in a conflagration all carved stone and thin edges would suffer. However, outside of the intense heat, the limestones would act best, while the other stones would be affected in the order: sandstone, granite, gneiss and marble.”

“ After having been heated to 850° C., most of the stones, as observed by Buckley, emit a characteristic ring when struck with metal, and when scratched, emit a sound similar to that of a soft burned brick. It will be noted that in those stones in which iron is present in a ferrous condition the color was changed to a brownish tinge owing to the change of the iron to a ferric state. If the temperature does not exceed 550° C.,

all the stones will stand up very well, but at the temperature which is probable in a conflagration, in a general way, the finer-grained and more compact the stone and the simpler in mineralogical composition the better will it resist the effect of the extreme heat. The order, then, of the refractoriness of the New York stones which were tested might be placed as sandstone, fine-grained granite, limestone, coarse-grained granite, gneiss and marble."

Expansion and contraction of building stone. — Building stones expand when heated and contract when cooled, but do not return to their original length. This slight increase in size is known as the *permanent swelling*. Although it is a very small amount when a piece of stone one foot long is being considered, still it may be appreciable when it involves a mass of masonry 100 or 200 feet in length.

The following averages are based on experiments made at the Watertown, Mass., arsenal,¹ the permanent swelling being for a bar of stone 20 inches long, heated and cooled through a range of temperature from 32° F. to 212° F.

Kind of stone.	Inch.
Granite.....	0.004
Marble.....	0.009
Limestone.....	0.007
Sandstone.....	0.0047

If the stones were set tight, with no joints, buckling of the wall might follow, but it is probable that the cement joints take up some of the increase in size. But even so, engineers sometimes allow for this expansion by putting in some elastic joints of asphaltic material or tar felt. The practice is not a universal one however.

COEFFICIENTS OF EXPANSION OF STONES, AS DETERMINED IN WATER BATHS

Name.	Location.	Original gaged length in air.	Temperature.				Coefficient of expansion.
			Hot.	Differ-ence.		Differ-ence in length.	
				Deg.	Deg.		
		Ins.	Deg.	Deg.	Deg.	Ins.	
Buff oolitic limestone	Bedford, Ind..	20 0033	178	33 5	144 5	0 0109	0 00000375
Limestone	Indiana.....	20 0084	177	33.5	143 5	0 0103	0 00000376
Marble	Vermont.....	19 9989	203	24	169	0 0122	0 00000361
Marble	Lee, Mass. ...	20 0061	189 5	33 5	156	0 0175	0 00000582
Red sandstone	Maryland.....	20 0034	183	33 5	149 5	0 0152	0 00000501
Red sandstone	Portland, Conn	19 9912	180	33 5	146 5	0 0154	0 00000526
Sandstone	Ohio.....	20 0019	183	33 5	149 5	0 0186	0 00000622
Slate	Monson, Me. . .	19 9954	194	34	160	0 0158	0 00000500
Bluestone	New York.....	20 0052	192	33 5	158 5	0 0189	0 00000596
Granite	Milford, Mass. .	20 0023	183	33 5	149 5	0 0122	0 00000408
Granite	Quincy, Mass. .	19 9951	199	33 5	165 5	0 0126	0 00000381
Granite	Rockport, Mass. .	19 9303	181	33 5	147.5	0.0091	0.00000311

¹ Report on Tests of Metals, etc., at Watertown Arsenal, U. S. War Department, 1895, p. 322.

The preceding table gives the coefficients of expansion of a number of stones as determined in a water bath.¹

Modulus of elasticity. — This term is synonymous with coefficient of elasticity, and can be defined as the weight required to stretch a rod of one square inch section to double its length.

Baker states that it is valuable in determining the effect of combining masonry and metal, of joining different kinds of masonry, or of joining new masonry to old; in calculating the effect of loading a masonry arch; in proportioning abutments and piers of railroad bridges subject to shock, etc.

A method of determining it consists in measuring the amount of compression which a 2-inch cube of stone shows for each increment of 500 to 1000 pounds load to the limit of its elasticity. The modulus of elasticity is then computed from these data by means of an empirical formula.

Few determinations have been made of this property of building stones, but the following are taken from the report of Buckley on the Wisconsin building stones (Ref. 78.)

Kind.	Locality.	Position.	Modulus of elasticity, lbs. per sq. in.
Granite.....	Amberg.....	201,000
“.....	Amberg.....	951,500
“.....	Granite Heights.....	1,450,000
“.....	Montello.....	1,653,000
Limestone.....	Duck Creek.....	Bed.....	462,800
“.....	Burlington.....	Bed.....	31,500
“.....	Burlington.....	Edge.....	501,300
“.....	Fountain City.....	Bed.....	171,000
“.....	Fountain City.....	Edge.....	237,900
Sandstone.....	Presque Isle.....	Bed.....	114,500
“.....	Presque Isle.....	Edge.....	94,000
“.....	Dunnville.....	Bed.....	103,420
“.....	Dunnville.....	Edge.....	145,300
“.....	Houghton.....	Bed.....	170,600
“.....	Houghton.....	Edge.....	151,300
“.....	Bass Island.....	Bed.....	76,300
“.....	Bass Island.....	Edge.....	64,900

Abrasive resistance. — The abrasive resistance of a stone depends in part on the state of aggregation of the mineral particles and in part on their individual hardness. Some stones wear very unevenly because of their irregularity in hardness, and may be less desirable than those which are uniformly soft.

¹ Report on Tests of Metals, etc., U. S. War Dept., 1890.

The abrasive resistance of a stone has to be considered whenever it is placed in a position where it is subjected to rubbing action. Such situations include the use of a stone for steps, for paving or flooring purposes,¹ or for lining troughs or tunnels where it is subjected to the abrasive action of running water carrying mud or sand. Moreover, in dry climates having sandy soils, which are frequently transported by strong winds, or along the sea coast where dune sand is moved by the same forces, the stone is subjected to the grinding action of a natural sand blast.

Many rock outcrops exposed to abrasive action show a very irregular surface, because the softer minerals have been worn away, leaving the harder ones standing out in knotty form.

A test to determine the abrasive resistance of a stone should, therefore, be made on those which are to be used for paving, steps, flooring, or wherever they have to stand rubbing action.

Several methods for determining the abrasive resistance of stone have been suggested, but none universally adopted.

The common method consists in laying the stone to be tested on a rubbing table, weighting it down, and applying emery or some other abrasive at a given rate while the table revolves.

The difficulty with this method lies in not being able to feed the sand at a uniform rate, and in being sure that all of it passes under the test piece.

The method is of value chiefly for comparative purposes, where several pieces of stone are tested at the same time.

Gary² endeavored to perfect the test by cutting slabs of 50 square centimeters surface parallel with the bedding. These were held down with a 30-kilogram weight and placed 32 centimeters from the center of a circular rubbing plate. At one minute intervals, 20 grams of Naxos emery of a certain size were strewn on the table. The abrasive and abraded rock remained on the table until the completion of 110 revolutions, which consumed about five minutes. No water was used. The loss of weight of the stone indicated the amount of abrasion.

Another method devised by Gary³ which seems to the authors to be a better one, involves the use of a sand blast. In the specially devised apparatus the sand is forced through a six centimeter diameter opening, under a dry steam pressure of 3 atmospheres, for 2 minutes. The stone to be tested is held immediately over the opening.

The following figures give the results obtained by Gary with both methods.

¹ It is not uncommon to see floors paved with marbles of different colors, and very different abrasive resistance.

² Baumaterialienkunde, II, p. 11, 1897-98. ³ Baumaterialienkunde, X, p. 133, 1905.

ABRASION TESTS MADE BY GARY.

Name.	Abrasion on rubbing table.				Abrasion with sand blast at right angles to bedding.		
	Surface, sq. cm.	Aver. loss, ccm.	Abrasion, in sq. cm.	Aver. loss, ccm.	Abrasion, sq. cm.	Aver. loss, ccm.	Abrasion, sq. cm.
Basalt.....	50	5.4	0.11	1.70	0.06	1.81	0.06
Basalt lava.....	49	9.6	0.20	6.01	0.21	7.06	0.25
Granite.....	49	5.1	0.10	2.64	0.09	3.78	0.13
Gneiss.....	48	9.6	0.20	4.01	0.14	3.26	0.12
Porphyry.....	49	8.5	0.17	3.29	0.12	2.58	0.09
Graywacke.....	50	10.8	0.22	4.24	0.15	4.16	0.15
Sandstone.....	50	18.4	0.37	11.15	0.39	8.42	0.30
Schist.....	50	29.7	0.59	8.02	0.28	5.90	0.21

The sand-blast treatment not only tests the abrasive resistance, but also brings out irregularities in the hardness.

Frost resistance. — A good building stone should resist the action of frost. The disintegration by frost is due to the water absorbed by the stone freezing within its pores. This of course arises from the fact that the change of water to ice is accompanied by an increase in volume of one-eleventh, and the internal pressure resulting from this may be sufficient to disrupt the stone.

With other things equal, one might expect a stone of high absorption to break more easily than one of low absorption. This, however, is not always the case, for there are variable factors which affect the result. Among these may be mentioned the size, shape, and distribution of the pores, as well as the rigidity of the rock.

A rock of high porosity may absorb a high percentage of water, and yet not disintegrate on freezing, because either the water drains off rapidly, or else if it should remain in the stone is forced outward, through the large pores, when it freezes.

On the other hand, a stone with small pores, or irregular ones, retains longer the water absorbed by it, and this on freezing often exerts sufficient internal pressure to split the stone.

It must be remembered, however, that the extent of the damage done depends on how completely the pores are filled.

A stone soaked under normal atmospheric pressure is not likely to be completely saturated, while one soaked in a vacuum will have its pores pretty well filled with water.

How different these results are is shown in the following table in which I represents the number of times the stone stood freezing without

injury after soaking under normal atmospheric pressure, while II shows the number of times the stone was frozen after soaking in a vacuum (Hirschwald, Ref. 4.).

EFFECT OF FREEZING A STONE WITH PORES PARTIALLY AND COMPLETELY FILLED

Kind of rock.	I.	II.
Limestone.....	31 times, no effect	5 times, broken in two
Marble.....	25 times, no effect	3 times, cracked
Sandstone.....	25 times, no effect	8 times, spalled off
Tuff.....	25 times, no effect	14 times, many cracks
Coarse granite.....	Unaffected	8 times, mica scales detached

The splitting of a stone when exposed to freezing temperatures is, however, not necessarily due solely to absorbed water, for as previously explained it may be due to quarry water.

Careful consideration should, therefore, be given by the engineer to the frost resistance of a building stone: (1) By not quarrying stratified rocks in cold weather; (2) by the selection of a rock of known high frost resistance; and (3) by not placing porous or absorbent rocks in a position where they are sure to absorb considerable moisture.

Laboratory tests made to determine the frost resistance should as far as possible simulate the conditions of use.

Freezing method. — The most logical method of making a frost test consists in thoroughly soaking the stone, and then exposing it to a temperature below freezing, this being repeated about 20 times. The stone is weighed before and after the tests and any loss of weight measured in percentage terms of the original dry weight.

Other effects of alternate freezing and thawing may be: (1) Formation of cracks; (2) detaching of grains from surface; and (3) loss of strength.

The second type of loss might occur in a laboratory test without being accompanied by any serious disintegration of the stone, as the surface of many dressed stones is coated with partly loosened grains.

Buckley, in a series of tests made on Wisconsin stone subjected to thirty-five alternate freezings (outdoors) and thawings, found the following losses in weight: Granites and rhyolites, not over 0.05 per cent; limestones, not over 0.03 per cent; and sandstones, not over 0.62 per cent.

A set of Missouri building stone tested by the same author gave the following losses: Limestones, 0.006–0.909 per cent; sandstones, 0.111–0.591 per cent.

Sulphate of soda test. — An artificial method consists in soaking the stone in a solution of sulphate of soda, and then drying it out, the theory being that the growth of the sulphate of soda crystals in the pores of the rock exerts internal pressure. The treatment is repeated a number of times.¹

The test is much more severe than the ordinary freezing test, and may give abnormal losses as the following figures taken from Luquer's experiments will show.

ARTIFICIAL AND NATURAL FROST TESTS

Stone.	Loss of weight in parts per 10,000	
	Sulphate.	Freezing.
Medium, crystalline dolomitic marble	17.01	2.30
Fine-grained limestone	25.99	2.07
Coarse-grained red granite	15.51	1.38
Fine-grained gray granite	5.16	1.50+
Norite, "Au Sable granite"	3.84	1.50+
Decomposed sandstone	482.12	68.74
Very fine-grained sandstone	47.65	10.63
Sandstone	145.18	14.21
Decomposed sandstone	1621.31	25.31

In the arid regions of the West, alkali salts are abundant in some soil and river waters. The absorption by stone or concrete of water containing these leads to their crystallization in the pores of the rock and causes disintegration. (Plate LX, Fig. 2.)

The structure of a stone sometimes hastens its disintegration under frost action. Thus a laminated rock, such as a sandstone, is apt to split rather easily along the bedding planes, and this may be hastened if the stone is set in the building on edge instead of on bed.

Effect of atmospheric gases. — Carbon dioxide and sulphuric acid gases are present in the atmosphere of some localities in appreciable quantities. This is especially true in the vicinity of factories, smelters, railroad yards, etc., where these acid gases are being discharged into the atmosphere from chimneys.

If moisture is present this not only acts as a carrier for the gases but serves to aid chemical action when they come in contact with the surface of the stones of many buildings (Ref. 3a).

Another possible source of sulphuric acid may be from the decay of pyrite in the rock itself.

Limestones, or other rocks with calcareous cement, are most affected

¹ Luquer, Trans. Amer. Soc. Civ. Engrs., XXXIII, Mar., 1895, p. 235.

by acid gases of the atmosphere. The result may be a very slow and usually uneven solution of the stone, which in the end causes a roughening of the surface or sometimes even scaling off of the rock.

Chemical composition of building stone. — The chemical analysis of a building stone is usually of very little commercial value, for three reasons, viz.: (1) Many persons have not sufficient knowledge of chemistry and mineralogy to interpret it; (2) it is often incomplete, and does not indicate the presence of injurious elements; and (3) what information is obtainable can usually be had more readily by other methods, especially microscopic ones.

It is true, of course, that different kinds of stone show a more or less characteristic chemical composition. Igneous rocks on chemical analysis show silica, alumina, and varying proportions of iron oxides, lime, magnesia, and alkalies, depending on the kind of rock.

Limestones if pure consist solely of calcium carbonate, and dolomites of calcium and magnesium carbonate, but if containing clayey impurities they show some silica, alumina, iron oxide and also some chemically combined water.

Sandstones if pure show little else but silica. If clayey they carry alumina, iron oxide, and some chemically-combined water in addition. If calcareous they may show several per cent of lime.

Microscopic examination. — This consists in examining a thin section of the rock under the microscope by polarized light. It serves to indicate the presence (especially in igneous rocks) of many accessory minerals of secondary importance, not visible to the naked eye, or of minute grains of injurious minerals. In some cases it may reveal that the cause of splitting in an apparently homogeneous stone may be due to elongation of the grains in one direction.

The microscopic examination may also show incipient weathering and structures not visible to the eye alone.

It is possible to calculate the percentage mineral composition of a rock from *both* the chemical analysis¹ and microscopic examination, and if this is done the one can be used to check the other.

The percentage of different minerals present in a rock, as determined by the microscope, is conveniently made by the Rosiwal method. This method was devised by Rosiwal, an Austrian geologist, for determining the approximate proportions of the chief minerals (feldspar, quartz, mica and hornblende) by means of the microscope.

¹ It consists² in tracing a network of lines intersecting one another at right angles upon a polished rock surface, at intervals so far distant that no two parallel lines

¹ Kemp, Handbook of Rocks.

² The description is quoted from Dale, Bull. 354, U. S. Geol. Survey.

will traverse the same mineral particle. The total length of the lines is measured, then the diameters of all the particles of each kind of mineral are added separately and their proportion to the total length of the lines obtained. The average size of the particles of each mineral can be also calculated from the same measurements. Although this method was primarily designed for application to the coarse and medium granites, it can be extended also to the finer ones by drawing the lines upon camera lucida sketches made from thin sections of such granites under polarized light."

Igneous Rocks

Of the many kinds of igneous rocks, the granites and granite gneisses are more extensively employed for building stone than any others in the United States.

This is due to several causes, such as wider distribution, more pleasing color, uniformity of texture, and greater regularity of structure such as jointing, as well as greater durability.

The other plutonic igneous rocks are employed occasionally either because they form a convenient source for local use, or because in special cases their natural beauty may make them of value for ornamental purposes.

Volcanic rocks have a more restricted use than the plutonic ones. Some are rather soft and porous, and can, therefore, be used only in mild climates.

Granites

Definition. — The term *granite*, as commonly used by quarrymen, includes all igneous rocks and gneiss. It seems best, however, to use it in the geological sense, which is more restricted. It may, therefore, be defined as an even-granular, crystalline, plutonic, igneous rock, consisting of quartz, and alkalic feldspar, with usually mica, hornblende or pyroxene. There are also varying amounts of other feldspars, and a large number of subordinate accessory minerals, few of which except pyrite and garnet are visible to the naked eye, or likely to be recognized by any one not having a knowledge of mineralogy (see Chapter II on Rocks).

Properties of granites. — Since the granites are the most widely used of the igneous rocks, their properties have been more thoroughly investigated in this country. It may be said, however, that many other plutonic rocks of granitoid texture including gneisses resemble the granites in their absorption, crushing strength, transverse strength, fire resistance, etc.

Specific gravity. — The average specific gravity of granite is about 2.662, which is equivalent to two long tons, or 4480 pounds per cubic yard, or about 165 pounds per cubic foot.

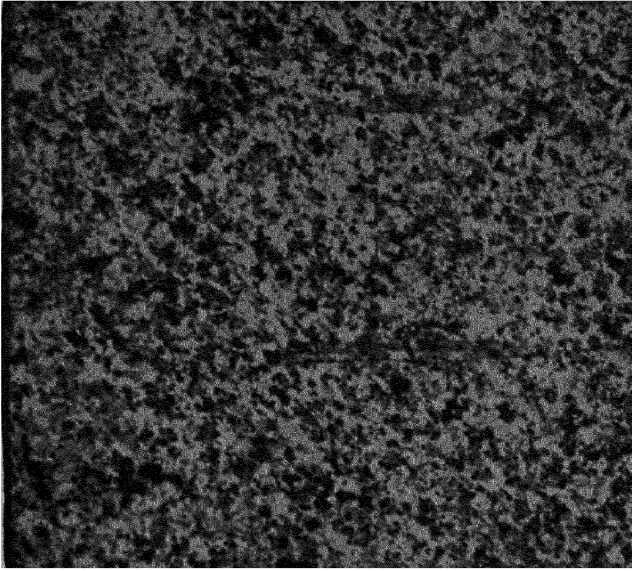

PLATE LXII, FIG. 1. — Moderately fine-grained granite, Hallowell, Me.

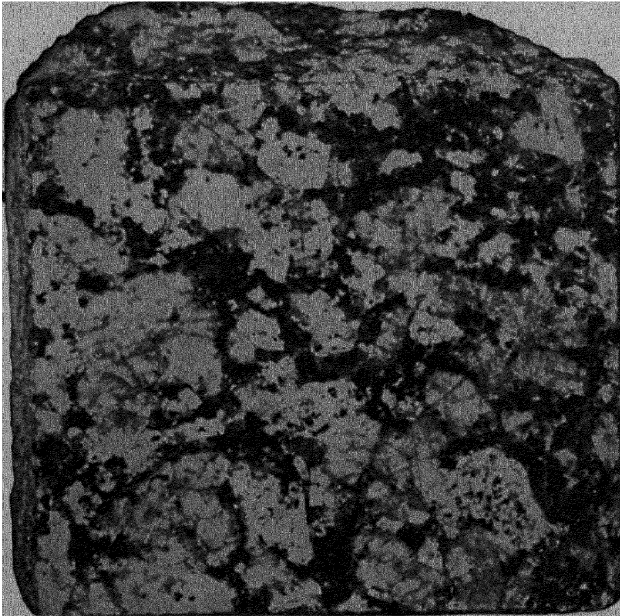

FIG. 2. — Very coarse-grained granite, St. Cloud, Minn.

Crushing strength. — The ultimate crushing strength was found by Buckley in Wisconsin granites to vary from 15,000 to 43,973 pounds per square inch, but 15,000 to 30,000 pounds would be the more usual range.

Texture. — The texture of granites is usually even granular or granitoid, but sometimes it is porphyritic. The granitoid ones may be fine-, medium-, or coarse-grained. Other things being equal, a fine-grained granite is usually more durable than a coarse-grained one, and the latter in turn longer lived than a porphyritic one. Finer-grained granites also lend themselves to carving for ornamentation better than the coarse-textured varieties.

Absorption. — Granites, if fresh, always show a low absorption, usually less than one per cent when fresh. Their porosity is consequently small, and there is little danger from quarrying them in freezing weather.

Elasticity. — This property is rarely tested. Specimens from Connecticut, Maine, Minnesota and New Hampshire, showed that pieces with a gaged length of 20 inches, and a diameter of 5.5 inches at the middle, when placed under a load of 5000 pounds per square inch, compressed from 0.0108 to 0.0245 inches. This resulted in a lateral expansion of from 0.005 to 0.007 inch, and gave ratios of lateral expansion to longitudinal compression ranging from 1 : 8 to 1 : 47.¹

Flexibility. — Granite, in spite of its apparently rigid character, is flexible in sheets of sufficient thinness and area. Dale states that sheets half an inch thick and 4 feet long, from a Maine quarry were flexible, but suggests that this flexibility may have been due to the partially disintegrated character of the stone.²

Fire resistance. — Granite spalls off badly under the combined influence of fire and water, which may be due to the differential expansion and contraction of the outer and inner portions of a block. It may also be due to the vitreousness of the quartz, and the presence of liquids and gases contained in microscopic cavities of the quartz, which expand violently on being heated.

Color. — The color of granites, as of other feldspar-bearing igneous rocks, depends on the color of the prevailing mineral, feldspar, and the proportion of light and dark minerals.

Pink or red granites are not uncommon, and owe their color to that of the prevailing mineral, feldspar. Probably the most frequent color of granite is some shade of gray, which is determined by the ratio of dark to light-colored minerals, and the light nearly white color of the feldspars.

¹ Report on Tests of Metals, etc., U. S. War Dept., 1896, pp. 339-348.

² U. S. Geol. Survey, Bull. 313, pp. 22 and 151, 1907.

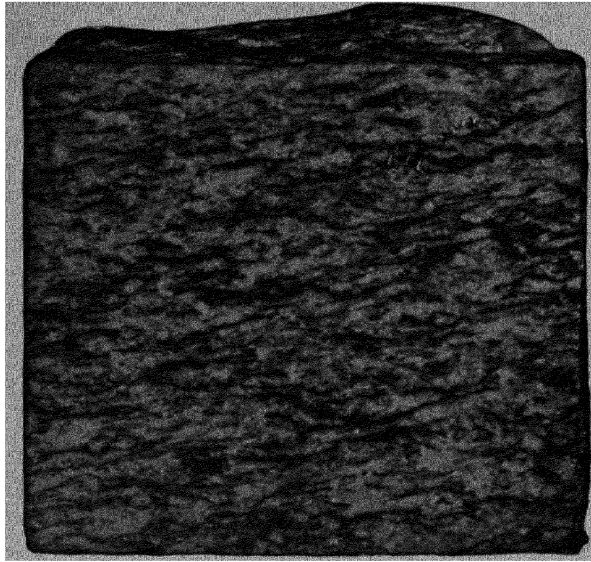

PLATE LXIII, FIG. 1. — Port Deposit, Maryland, gneissic granite with face cut at right angles to banding.

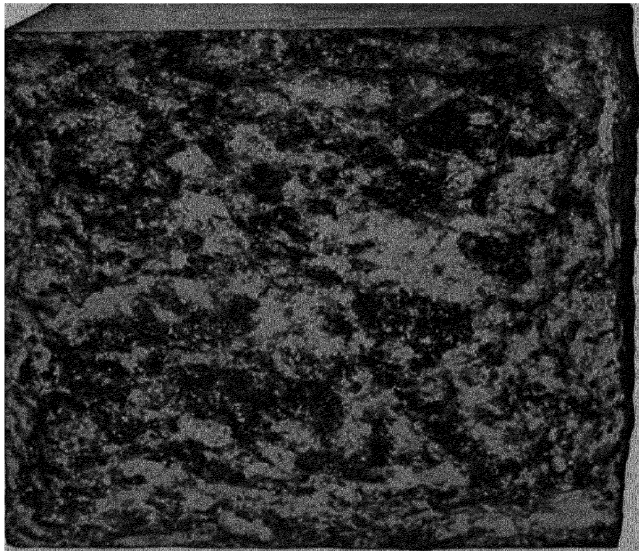

FIG. 2. — Port Deposit, Maryland, gneissic granite with face cut parallel to the banding.

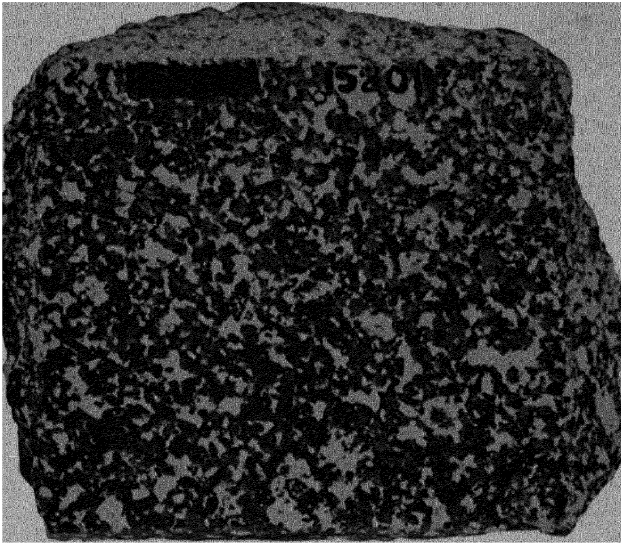

PLATE LXIV, FIG. 1. — Diorite from Perris, Calif., showing contrast between light and dark minerals.

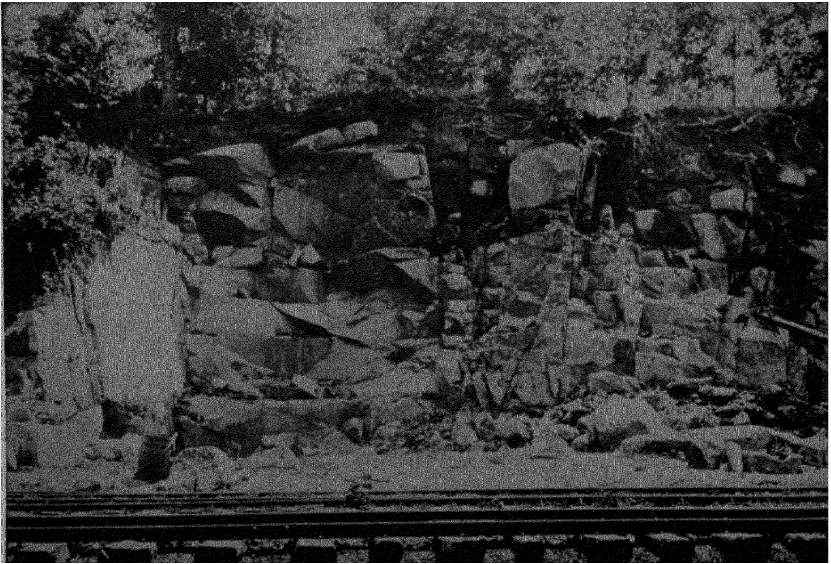

FIG. 2. — Boulder quarry, Richmond, Va. (H. Ries, photo.)

Cases are known of some deep-pink granites fading on prolonged exposure to the sunlight.

Classification. — Granites may be classified according to their mineral constituents, texture, color, or even uses, but no one of these is satisfactory as a basis. The varietal names are given in Chapter II.

Structure of granites. — Fortunately for the quarrymen joints are present in almost every granite quarry and greatly facilitate the extraction of the stone, but they vary in their regularity.

In most quarries the rock mass is broken into sheets or beds by joints which are roughly parallel to the surface, but which, owing to their divergence and convergence, break the granite into a series of flat lenses.

In addition to these there are usually one or more systems of vertical joints. The spacing of these several sets of joints will of course determine the size of block that can be extracted from a given quarry. Monoliths 50 feet long and 4 feet square are not difficult to obtain.

When weathering has taken place along the joints, the rounded blocks of stone resemble boulders, and hence the name *boulder-quarry* (Plate LXIV, Fig. 2). This feature is most commonly seen in the southern quarries, where the products of rock decay have not been removed by glacial action. Where present it necessitates at times the removal of much unsound or partly decayed stone, in order to uncover the sound material. Although these boulders may appear to be fresh interiorly, they are not infrequently traversed by minute cracks, which do not become noticeable until the stone is put in use. Their selection is, therefore, undesirable.

The *rift* is an obscure foliation, either vertical (or nearly so) or horizontal, along which the granite splits more readily than in any other direction, while the grain is a direction at right angles to the rift, along which the stone splits less readily.

Rift and grain are not necessarily pronounced; indeed, either or both may be poorly developed or absent. A change in the direction of the rift is called the *run*.

The *cut off* or *hardway* is a term used to indicate the direction along which granite must be channeled because it will not split.

Sheets is a term used to designate the division of granite by joint-like fractures which are variously curved or almost horizontal, and nearly parallel with the surface. The sheets usually become thicker with depth.

Knots are segregations varying greatly in size, but usually roundish in outline. They are made up chiefly of the darker minerals and often form unsightly spots in granite. They are mainly objectionable because

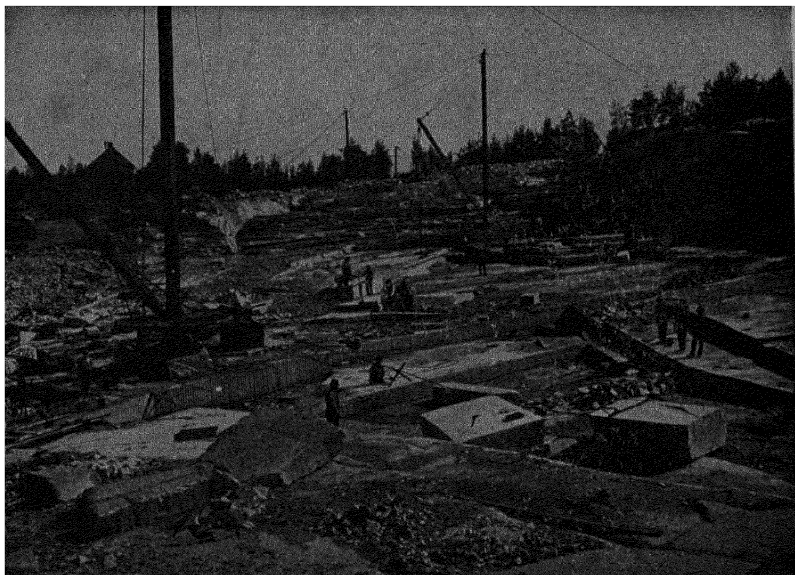

PLATE LXXIV, FIG. 1. — Granite quarry at North Jay, Me. (Photo loaned by
Maine and New Hampshire Granite Company.)

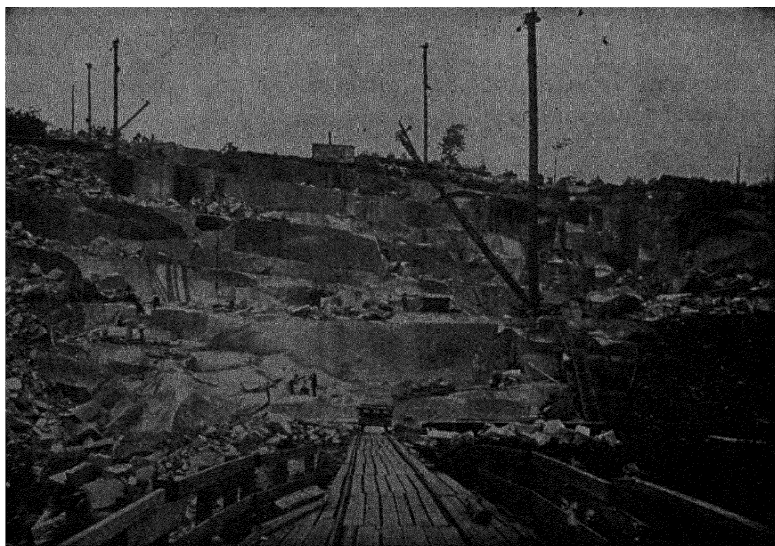

FIG. 2. — Granite quarry, Hardwick, Vt. (From Ries' Economic Geology.)
(481)

they mar the beauty of the stone, but in some plutonic rocks they are so numerous and symmetrical in form as to be of ornamental character.

Inclusions. — Many granites contain angular fragments of other rocks, such as schists, gneisses, limestone or even other granites, which become incorporated in the granite during its intrusion. Those portions of the rock containing them often have to be discarded.

Dikes. — In some granite quarries the stone is traversed by dikes of other igneous rock, such as diabase, or in most cases pegmatite. They are objectionable; because (1) the stone containing them is of no value for dimension work; (2) the rock on either side of them is often rendered worthless by shattering; and (3) an otherwise good stone may be so permeated with small dikes as to seriously decrease its usefulness.

Uses of granite. — Granites on account of their usually great durability, variety of color, susceptibility to polish, and texture, are among the most widely-used of building stones. The coarser- and medium-grained ones are well adapted to massive work, such as the construction of large buildings, sea-walls, dams, bridge piers, dry docks, etc.

Distribution of Granites and Granite-Gneisses

Granite forms an important source of building stone, somewhat widely distributed in the United States, but probably 70 per cent of that quarried comes from the eastern United States, where extensive deposits, owing to their favorable location for working and shipment, together with their nearness to large markets, have been developed on an enormous scale. Gneisses, usually of granitic composition, are also widely employed in the eastern states. Under this head there are also included certain closely allied rocks such as grano-diorites, etc.

The producing areas are: (1) Eastern belt extending from Maine, southwestward to northern Alabama. (2) Minnesota-Wisconsin area. (3) Southwestern area, including isolated districts in Missouri, Oklahoma and Texas. (4) Cordilleran area, including parts of Colorado, California and other western states. (5) Black Hills area of South Dakota.

Eastern crystalline belt (Refs. 14, 25, 28, 35, 38, 40, 45, 50, 58, 60, 66, 73). — This belt which extends from northeastern Maine to northern Alabama contains a number of granites and granite-gneisses, which range in age from pre-Cambrian to Carboniferous, but are mostly the former.

Without a detailed discussion, the following table may suffice as a statement of the more important occurrences.

State.	Locality.	Kind.	Texture.	Color.
Maine	North Jay	Biotite-muscovite granite	Fine	Light gray
	Hallowell	Biotite-muscovite granite	Fine	White
	Crotch Island Fox Islands	Biotite granite Biotite granite	Coarse Coarse	Light gray Pink gray
New Hampshire	Concord	Muscovite-biotite granite	Fine-medium	Bluish gray
	Fitzwilliam	Muscovite-biotite granite	Fine	Light bluish gray
	Marlboro	Biotite-muscovite granite	Fine	Light bluish gray
	Lebanon Canaan Redstone	Biotite-granite gneiss Biotite-granite gneiss Biotite granite	Gneissoid coarse Gneissoid coarse Coarse	Pink gray Light buff gray Light pink mottled
Vermont	Woodbury	Biotite granite	Fine-medium	Bluish gray
	*Barre	Biotite granite	Fine	Shades of gray
	Hardwick	Quartz-monzonite	Medium	Dark gray
	*Windsor	Hornblende-augite granite	Medium	Olive green
	Bethel	Quartz monzonite	Medium	Light
Massachusetts	Milford	Biotite granite	Medium slightly gneissoid	Pink gray
	Fall River New Bedford	Biotite-granite gneiss Biotite-muscovite granite gneiss	Coarse Coarse sometimes gneissoid	Pink gray Light pink gray
	Rockport	Hornblende-granite	Medium to coarse	Gray and green
	*Quincy	Hornblende pyroxene granite	Medium to coarse	Gray or greenish shades
	*Chester	Muscovite-biotite granite	Variable	Blue gray
Rhode Island	*Westerly	Quartz monzonite and biotite granites	Fine	Pink, blue
Connecticut	Stony Creek Greenwich	Biotite granite gneiss Mica-diorite gneiss	Coarse gneissoid Coarse, porphyritic gneissoid	Pink Blue gray
	Leete Island	Biotite-granite gneiss	Medium gneissic	Red gray
New York	St. Lawrence County	Granite	Fine to coarse	Pink
New Jersey	Compton	Granite	Coarse grained	Pink
Maryland	Port Deposit Woodstock	Biotite-granite gneiss Biotite granite	Fine, gneissic Medium	Gray Gray
	Baltimore	Gneiss	Variable	Blue gray
Virginia	Fredericksburg	Biotite granite	Medium to fine-grained	Blue gray
	Petersburg Richmond	Biotite granite Biotite granite	Medium Fine to medium	Gray Gray and blue gray
North Carolina	Mt. Airy Salisbury Greystone	Biotite granite Biotite granite Biotite granite	Medium Fine Fine to medium, gneissoid	Light gray Pink or light gray Gray to pink gray
South Carolina	Columbia Rion	Biotite granite Biotite granite	Fine to coarse Medium	Gray Gray
	Heath Springs	Biotite granite	Fine	Blue gray
Georgia	Stone Mountain	Biotite muscovite granite	Fine to medium	Light gray
	Lexington	Biotite granite	Fine	Blue gray
	*Oglosby Sparta	Biotite granite Biotite granite	Fine to medium Medium to coarse	Blue gray Gray

* Used also for monumental purposes.

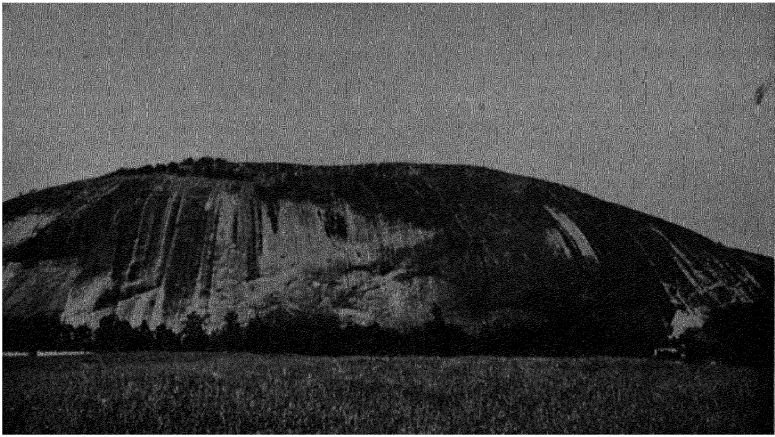

PLATE LXVII, FIG. 1. — General view of Stone Mountain, Ga. (After Watson, U. S. Geol. Survey, Bull. 426.)



FIG. 2. — Quarry of granite along base of Stone Mountain, Ga., shows sheeting following surface. (After Watson, *Ibid.*)

The rocks are usually some shade of gray, pink being less frequent. They are medium- to fine-grained in texture, and even-granular to porphyritic. Practically all are of excellent durability. The New England ones have been worked the longest and are hence more extensively developed. Indeed many of the granites located along the coast have been shipped to many southern points. In recent years, however, there has been considerable expansion in the quarrying industry of the southern states.

Minnesota-Wisconsin area (Refs. 42, 78). — There are several detached areas in these two states, which supply both constructional and ornamental granites. The best-known constructional granite in Wisconsin is the Wausau stone which is a coarse-grained red or gray rock. That obtained from Amberg is a fine-grained gray granite. Berlin supplies a fine-grained, grayish-black quartz porphyry utilized chiefly for paving blocks, while a highly ornamental fine-grained red granite, of value for monumental work, is quarried at Montello.

In Minnesota medium-grained pinkish granite and a fine-grained gray or red syenite is quarried at St. Cloud, while a dark-red medium to coarse-grained gray granite comes from Ortonville.

Southwestern area (Refs. 19, 43, 54, 65). — The several granite areas of Missouri, Oklahoma, and Texas are worked on a small scale, chiefly because they are located in a region of limited demand. The following types are mentioned:

State.	Locality.	Kind.	Texture.	Color.
Missouri	Graniteville	Biotite granite	Medium to coarse	Red
Texas	Knob Lick Wichita Mts.		Fine Coarse to fine	Gray to Red Gray
Oklahoma	Arbuckle Mts. Garnet County	Biotite granite	Coarse Coarse	Pink Pink

Cordilleran area (Refs. 6, 20, 23, 44, 75). — Granite is found in a number of the Rocky Mountain states, but has not been extensively quarried. On the Pacific coast there are several areas of importance in California. These include the Rocklin area which yields a gray biotite granite of varying texture and the Raymond area which supplies a medium-grained, light-gray, biotite granite. Granite has also been quarried in Riverside County.

Plutonic Rocks other than Granite

These in general resemble the granites in their physical properties, so that this topic requires no further discussion. We need, therefore, refer only to their distribution.

Syenite (Ref. 19). — This type of plutonic rock is comparatively rare, and is consequently but little used for structural work. The most important occurrence is near Little Rock, Ark., where the stone has been quarried for some years. The rock is bluish-gray, strong and durable.

Gabbro (Refs. 37, 38, 51). — Gabbro is little used for structural work. This is due to its lack of regular jointing, absence of pronounced rift and grain, dark color and often great toughness. It is sometimes selected for monumental work because of its fine color, and ability to take a good polish.

Gabbro is a common rock in the Adirondack Mountains of New York state, and is also known to occur in the vicinity of Baltimore as well as farther south in the crystalline area, around Lake Superior, and a few other scattered points. The Duluth, Minn., gabbro has been used as a building stone.

Diabase. — This type of rock is more apt to occur in dikes than in stocks and laccoliths. The most important occurrences are in Connecticut and in northeastern New Jersey (Ref. 46) and the adjoining parts of New York. Additional but smaller areas occur to the southwest as far as Alabama. The stone from these is sometimes used locally for road material, and in rarer cases for monumental purposes. In the New York region especially the rock is extensively quarried for road material, and to a lesser extent for paving blocks. It is seldom used for dimension stone, because of its great toughness, abundant and irregular jointing, as well as absence of rift and grain.

Volcanic Rocks

These vary from very porous soft materials like tuff to the hard dense basalts.

The use of basalt as a building stone is not widespread, in spite of the extensive areas of this rock in the west and northwest. Its very dark color, abundant jointing and irregular break make it rather unfavorable for dimension work.

The more acid, softer and usually more porous volcanic rocks, such as trachyte, rhyolite, and andesite, are rare in the east, and where they occur they are usually metamorphosed and not of much commercial value; but in the Rocky Mountain region, they are of common

occurrence and at times somewhat extensively employed for structural work.

The rhyolite quarried at Castle Rock near Denver, Colorado, and the andesite from Del Norte, Colorado, have both been much used. Their absorption is often high, but this is of minor importance in a dry climate. Their strength is also lower than that of the plutonic rocks, but still it is sufficient for structural work. The porous ones should not, however, be selected for any work where they are exposed to moisture, as in the construction of dams or reservoirs. Consolidated tuffs are also common in many parts of the Cordilleran region and for ordinary construction work give satisfactory results, being used at scattered points from Montana to Arizona. They are widely used in Mexico, and endure well in a dry and mild climate. Many are soft enough to saw and they are even more porous than the rhyolites and andesites.

Sandstones and Quartzites

Sandstones and quartzites, as already stated, are normally composed of grains of quartz bound together by some cementing substance. Other minerals may be and often are present, at least in small quantities. These accessory minerals include feldspar, mica, iron oxide, pyrite or even tourmaline. In rare cases feldspar predominates (see further, Chapter II).

Structural features. — Sandstones and quartzites always show a bedded structure, but the layers are not necessarily horizontal, and in regions of folding may tilt at a high angle. The thickness of the beds affects the size of the blocks that can be extracted, while their position affects the cost and method of quarrying employed. Jointing is present in all sandstone quarries, and the effect of this has already been explained (Chap. III).

In some sandstone formations shaly beds are not uncommon. If present in excess they cause much waste; if few they can be overlooked, and be thrown out as encountered. Of specially injurious character, however, are thin clayey or shaly streaks which occur in the sandstone beds, because these are liable to open up on exposure to frost and split the stone.

Properties of sandstones. — *Texture.* — Sandstones vary in texture from very fine-grained ones, through those of medium coarseness, to extreme cases in which the grains are quite large, so by increasing coarseness they pass into conglomerates. On the other hand by increasing fineness and increasing clayey matter they grade into shales.

Hardness. — Since the hardness of a rock, as already explained, depends in part on the state of aggregation of the mineral grains, the hardness of sand rocks will depend upon the tightness with which they are cemented together. A sandstone, therefore, although composed entirely of quartz grains may be so soft that a lump of it can be almost crushed under foot.

The cementing material in sandstone may be iron oxide, silica, calcium carbonate or clay. The quality and character of the cement affects the strength, durability, workability and even color of the stone. In some sandstones more than one kind of cementing material is present.

Silica cement is the most durable, but if present in too great quantity makes the stone hard to work. The Berea sandstone of Ohio contains a moderate amount of siliceous cement, while the Potsdam quartzite of New York is strongly cemented with the same material.

Iron oxide may also act as a strong binder, but probably to a less degree than silica, and at the same time it colors the stone.

Calcium carbonate, though giving a fairly strong cement is an undesirable one, for the reason that it is not only soft, but readily dissolves in carbonated waters. It can be detected usually by the fact that it effervesces when a drop of dilute muriatic acid is put on the stone. Small quantities of this cement are not harmful.

Clay cement has both its advantages and disadvantages. It is not a strong cement, and, moreover, serves to attract moisture to the stone; hence an excess of clay renders a stone liable to injury by freezing. A small amount softens the stone somewhat and makes it easier to work. The clay also gives the stone at times a dull, earthy look. If present the clay should be evenly distributed, and not concentrated in seams.

Color. — Buff, yellow and yellowish-brown colors are due to limonite, and red or red-brown tints are caused by hematite, while bluish-gray and black are due to clay or carbonaceous matter.

Uneven distribution of coloring matter produces a blotchy appearance. Many sandstones change color on exposure to the atmosphere due to oxidation of the iron compounds contained in them. This change is not necessarily a sign of decay, and the weathered rock may have a more pleasing tone than the fresh stone.

Absorption. — Sandstones show a wide range of absorption. Hard, dense ones like quartzite take up under 1 per cent of water, while porous ones may take up 10 or 11 per cent and more.

Crushing strength. — Sandstones often show a crushing strength of from 9000 to 12,000 pounds per square inch, but may fall below this, or run even considerably higher, especially if quartzitic in character

The following figures give some idea of their variation in crushing strength, as well as their other properties.

TESTS OF SANDSTONE

Locality.	Crushing strength.		Transverse strength, modulus of rupture.	Absorption, per cent.	Specific gravity.
	Position.	Lbs. per sq. in.			
Presque Isle, Wis.	Bed	6,244	574 6	8.89	
Presque Isle, Wis.	Edge	4,747			
Houghton, Wis.	Bed	4,549		15 22	2 582
Houghton, Wis.	Edge	4,000			
Dunnville, Wis.	Bed	2,502		10 33	2 649
Dunnville, Wis.	Edge	2,842			
Port Wing, Wis.	Bed	5,498	2073		2 35
Port Wing, Wis.	Edge	1,658			
Portland, Conn.		12,580		2 08	2 49
East Longmeadow, Mass.		12,210			
Potsdam, N. Y.				5 00	2 604
Marquette, Mich.		3,800			
Waltonville, Pa.		14,753		4 00	2 16
Kettle River, Minn.		11,547			
Berea, O.		11,213	777 97	7 64	2 649
Warrensburg, Mo.	Bed	5,911			
Warrensburg, Mo.	Edge	4,869		3 76	2 346
Flagstaff, Ariz.		6,309			
Colusa, Cal.		8,880		3 025	2 558
Columbus, Mont.		8,500			
Warsaw, N. Y.		19,022		3 9	2 34
Tenino, Wash.		5,750			
Medina, N. Y.		3,270		2 0	2 41
Medina, N. Y.	Bed	17,250			
Trinidad, Colo.	Edge	14,812		2 0	2 39
Trinidad, Colo.	Bed	10,110			
Trinidad, Colo.	Edge	9,665		.06	2 39

Durability. — Hard quartzites are usually of high durability, and withstand the attacks of the weather for a long period. Sandstones of low absorption and good hardness also show a long life as a rule, but some of the softer ones may disintegrate under frost action. Clay seams, as already mentioned, are sources of weakness, and mica scales, if abundant along the bedding planes are also liable to cause trouble. In both cases this is likely to be aggravated if the stone is set on edge instead of on bed.

The Connecticut brownstone forms a striking case in point. It was formerly much used in many of the eastern cities, and in order to get a smooth surface was rubbed parallel with the bedding. The stone was then set in the wall on edge. The result was that after the stone had been in place for 15 years it began to scale off badly parallel with the bedding planes. Had the rock been set in the building on bed much of this trouble might have been avoided.

Fire resistance. — Sandstones are perhaps as little affected by a temperature of 1500° F. as any building stones, but are likely to spall and crack when exposed to the combined action of fire and water.

Varieties of sandstone. — The varietal names have been given in Chapter II.

Distribution of Sandstones and Quartzites

Geologic distribution. — Sandstones have a wide geologic distribution, but the geologic age is not necessarily an index of quality, although we can state in general terms that those sandstones occurring in the older geological formations are usually harder and denser than those found in the younger ones. This being so it is fortunate that many occurrences of the second class are found in those parts of the United States where the climate is mild or dry.

Geographic distribution (Refs. 33, 37, 43, 48, 54, 56, 73, 77, 78). — It may seem superfluous to discuss the areal distribution of sandstones as there is hardly a state that does not contain deposits of them that are fit for quarrying.

In the eastern states one broken belt of brownstone¹ extends from southern Massachusetts southward to North Carolina and is quarried at a number of points.

Another belt of sandstones extends along the Appalachian Mountain range from Pennsylvania southward to Alabama. These vary from Ordovician to Carboniferous in age, and are quarried at a number of points for local use. The Medina sandstone quarried in western New York forms an isolated area of this belt.

In the central states there are a number of sandstone formations, which are worked here and there. Many of them occur in the Carboniferous. The most important is the Berea sandstone of northern Ohio, a widely-used sandstone at the present day; the Kettle River sandstone of Cambrian age of Minnesota is much used also.

Many sandstones often of porous character are quarried in the Cordilleran area, and form an excellent source of building material.

Limestones

Structural features. — Limestones are always stratified, but the beds vary in thickness in different quarries or even in the same quarry. Those deposits which show massive bedding will naturally be of greater value for extracting dimension stone. In most districts where limestones are quarried for structural work the beds lie flat or nearly so, but at times owing to folding of the rocks the beds may be tilted at varying angles. Jointing is rarely absent, and since limestones are more soluble in surface waters than sandstones the rock along these joints is sometimes more or less weathered by solution (Plate LX, Fig. 1).

¹ The typical brownstone is a brown sandstone, but the name often includes sandstones of other colors occurring in the same formation.

Vertical and horizontal variations may occur. Thus thick beds may alternate with thin ones, or shaly seams with limestones. Certain beds may be of even character, while others interbedded with them may be of cherty nature. As a result a good series of beds occurs at one level, while at a higher or lower level the beds may be worthless. Again, the limestones if followed up along the strike sometimes become shaly, or change in composition.

Bearing these facts in mind, it will be realized that in searching for a quarry site, the engineer should not base his conclusions on one or two outcrops.

Properties of limestones. — *Texture.* — Limestones show a variable texture, but the majority are fine-grained. Those which are coarse-grained are either strongly fossiliferous or else coarsely crystalline. The finer-grained ones split more evenly and have better weathering qualities. The texture does not necessarily bear any direct relation to the absorption.

Hardness. — Dense limestones are usually quite hard, while the more porous ones are likely to be soft. The French Caen stone much used for decorative work is a good example of a fine-grained porous one, while the Coquina rock of Florida is an excellent type of a very open coarse-grained stone.

Some are so soft as to be readily cut with a saw. The Bedford limestone of Mississippian (Lower Carboniferous) age, quarried in Indiana, is moderately hard, while the Shenandoah group of limestones of the southern states represents a very firm hard rock.

Color. — A pure limestone whether calcitic or dolomitic is white, but clayey or carbonaceous impurities tend to give it a grayish color and the former may also make it grayish or brownish black. Many of the latter fade slightly on exposure to the atmosphere.

Durability and mineral impurities. — Both limestones and dolomites of dense and massive character, as well as those free from mineral impurities, are of good durability, although not as long-lived as dense sandstones and granites.

Limestones weather primarily by solution; that is to say, rain or surface water may slowly attack the rock, but the solution of the surface is likely to go on very unevenly. If certain portions are silicified, such as fossils replaced by silica, or if quartz veins are present in the rock, these resist the solvent action of the surface waters more than the surrounding calcareous parts of the rock and are left standing out in relief, giving the stone a rough appearance

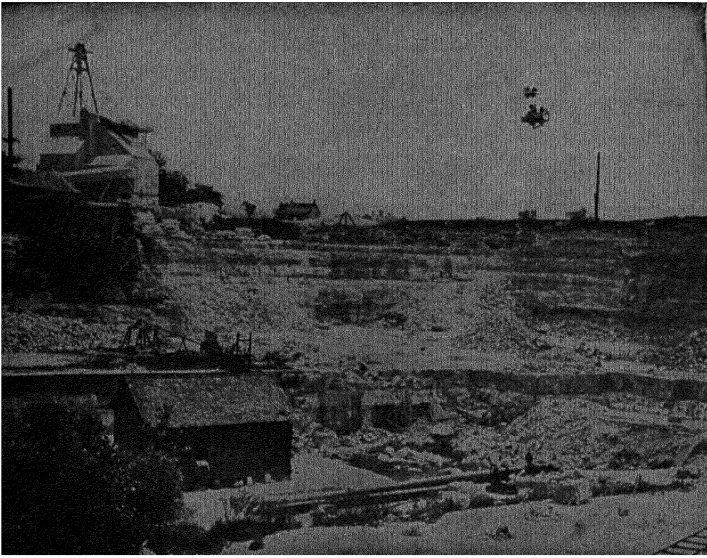

PLATE LXVIII, FIG. 1. — Horizontally stratified limestone, Milwaukee, Wis.
(From Rics, "Building Stones and Clay Products".)

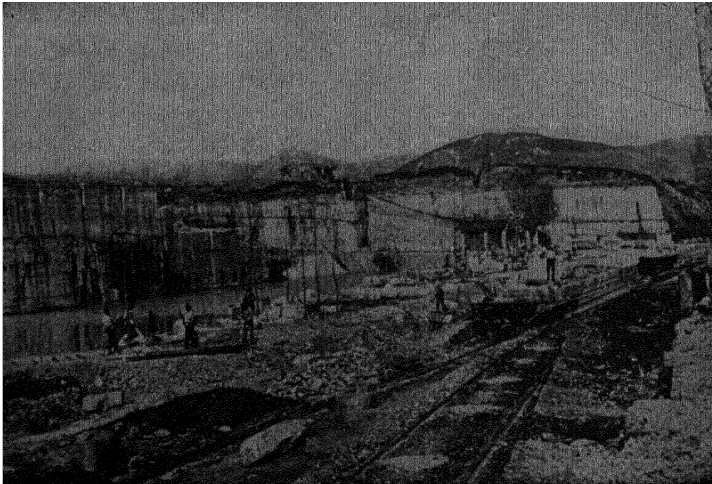

FIG. 2. — Quarry in calcareous tufa, Tivoli, Italy. (J. C. Branner, photo.)

Dolomites do not weather so readily by solution. Some coarse-grained ones disintegrate, breaking off a grain at a time.

Certain mineral impurities interfere with the value of the stone.

Pyrite is an undesirable one, not only because it weathers to rusty limonite, but for the reason that in this change sulphuric acid is set free, which attacks the rock.

Chert (Plate XIII, Fig. 2) is another common impurity in some lime rocks, the nodules usually being strung out in bands along the stratification planes. It not only causes the rock to weather unevenly, but interferes with the dressing of it, in drilling through it, and lastly imparts to the stone a tendency to split along the lines of the chert concretions when exposed to frost action. Cases are known where masonry composed of cherty limestone has split so badly as to necessitate its being replaced by fresh stone.

Absorption. — The majority of the harder limestones have a very low absorption, usually under two per cent. Some widely-used ones may run much higher. Thus the Bedford, Ind., limestone shows 4 or 5 per cent; the French Caen stone 10 to 12 per cent; the Roman travertine still more.

Fire resistance. — The resistance of limestone to fire, at temperatures below that required to convert the stone into quicklime, is usually fair, although lime rock, like other stones, is apt to spall badly under the combined attack of fire and water.

Crushing strength. — Most hard limestones show a good crushing strength, ranging from 9000 to 12,000 pounds per square inch, or sometimes very much higher.

The table on page 477, though not exhaustive, shows something of the variation of their crushing strength and other properties.

Chemical composition. — For structural work the chemical analysis of a limestone is of comparatively little value, but the following analyses are given for those who desire to see the range in chemical composition shown by limestones which are ordinarily employed for building purposes.

ANALYSES OF LIMESTONE

	I.	II.	III.	IV.
CaCO ₃	97.26	54.33	81.43	98.91
MgCO ₃	0.37	39.41	15.04	0.58
Al ₂ O ₃ }	0.49	0.26	0.57	0.63
Fe ₂ O ₃ }				
SiO ₂	1.69	3.96	2.89	0.10
H ₂ O.....		1.50	0.08

I. Bedford, Ind.; II. Newburg, N. Y.; III. Spore, O.; IV. Siluria, Ala.

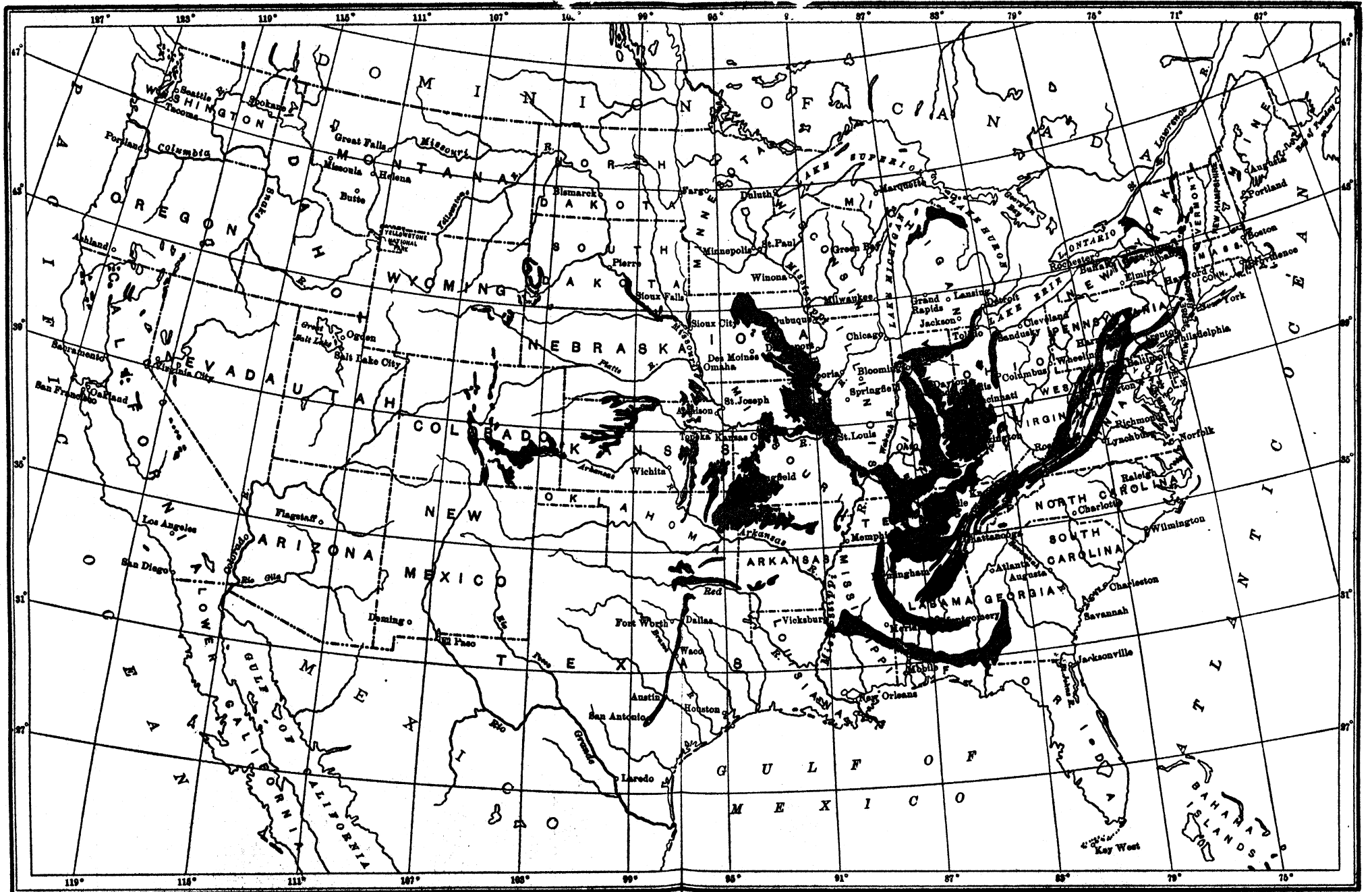

PLATE LXIX. — Map showing limestone areas of United States. (After U. S. Geol. Surv.)

Varieties of limestone and dolomite. — The different varietal names have been explained on p. 121.

Distribution of Limestones in the United States

Limestones are found in many states (Plate LXIX, and Refs. 6, 20, 30, 33, 37, 43, 46, 53, 73, 75, 78), and in all geologic horizons from Cambrian up to Tertiary. Those found in the older geologic horizons are on the whole denser and harder than those occurring in the younger ones. Because of their wide distribution, few areas have attained great importance.

In the Atlantic states an important belt of hard dense limestones extends from New York to Alabama following the Great Valley. This is known as the Shenandoah group of limestones, and has been opened at a number of points for structural work.

In the central states the Mississippian or Lower Carboniferous formation carries a number of important limestone deposits, of which that worked near Bedford, Ind., is the best known. Much is also supplied by the Devonian and Silurian formations. West of the Great Plains, however, there are no such extensive deposits as are known in the East, as a glance at the map (Plate LXIX) giving the distribution of limestone formations will show.

Marbles

Three types of rock are included under this head, viz., (1) crystalline limestones, or marbles proper; (2) onyx marbles, and (3) serpentine marbles.

Crystalline Limestones

These are metamorphosed limestones or dolomites, occurring in areas of metamorphic rocks.

Properties of crystalline limestones. — *Structure.* — These marbles are usually massively bedded, not abundantly jointed and the beds show a variable dip. Owing to their massive character they are commonly quarried with channeling machines.

Texture. — Marbles vary in texture from coarse to fine, and for general purposes the latter are preferred. Some ornamental ones show a brecciated structure, which although it may add to their decorative value renders them unfit for exterior use in a severe climate.

Color. — The range of colors shown by marbles is very great and this adds to their ornamental value. Some are white, others gray to

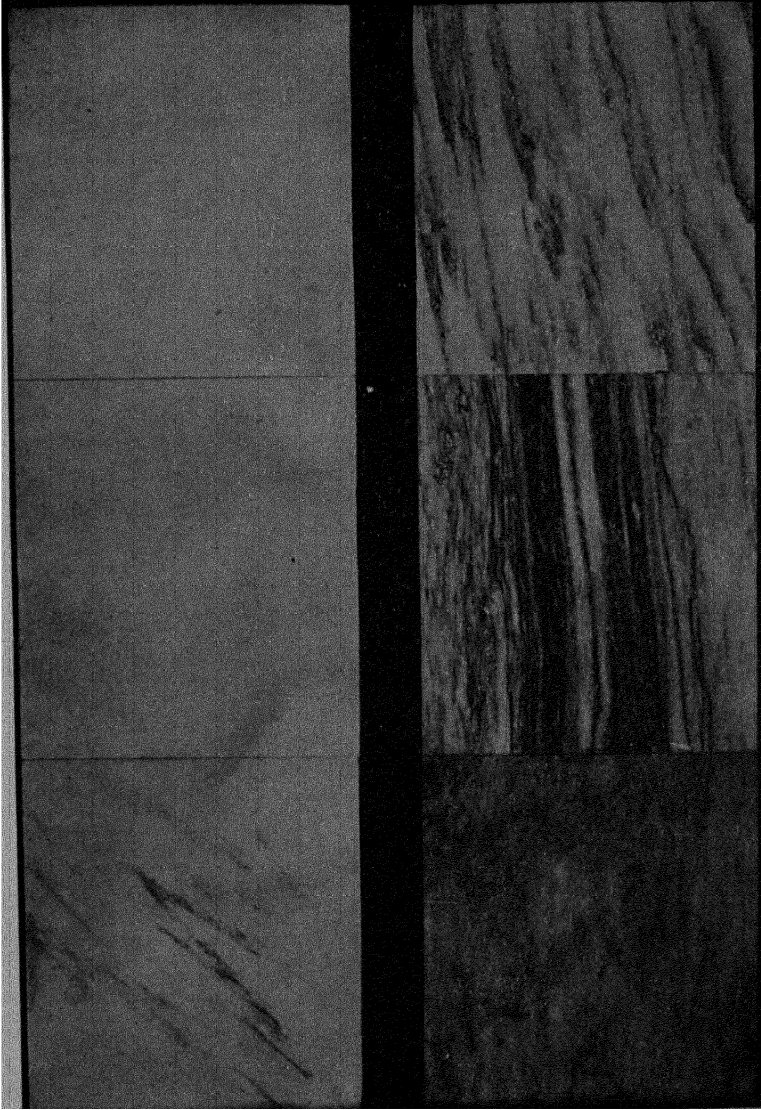

PLATE LXX. — Slabs of marble, showing plain white, and streaks, bands and mottlings produced by mica. (496)

black, due to carbonaceous matter; still others may show varying and often beautiful shades of red, pink, yellow, green, etc., due to iron compounds and micaceous minerals.

Mineral composition. — When pure, marbles are composed of calcite or dolomite, or a mixture of the two. Other minerals, if present, are often to be regarded as injurious impurities.

Pyrite is one of these and its effect is the same as in limestone. Mica is another. It occurs usually in fine scales which form blotches, or wavy bands. In small amounts it is not very harmful, but if abundant it lowers the weather-resisting qualities of the stone, the mica dropping out or decaying, and leaving a pitted surface. Micaceous marbles should not, therefore, be exposed to a severe climate.

Tremolite is found in some dolomitic marbles, and its light-colored, silky-lustered grains, when fresh, are easily recognizable. It weathers somewhat easily to a clayey material, so that, if abundant, the surface of the stone may become pitted as the tremolite weathers out. Its occurrence in a given marble deposit may be irregular. Quartz may occur in some marbles as veins, concretions, or thin layers. Such stone should be rejected. In some Vancouver Island marbles diopside and wollastonite grains, which are present in the rock, not only interfere with the production of a good polish but also weather out somewhat easily.

Durability. -- What has been said regarding the durability of limestones holds true for marbles, and to this should be added the fact that the presence of much mica or a brecciated structure are additional points of weakness.

TESTS OF MARBLE

Locality.	Crushing strength, average crushing strength.	Transverse strength, average modulus rupture.	Specific gravity.	Per cent absorption.	Weight per cu. ft.
Colville, Wash.....	19,000	2.87	0.16	178
South Dover, N. Y.....	19,000	2.86	0.267
Tate, Ga.....	12,800	2.71	0.008	169
Marble Hill, Ga.....	13,300	2.73	0.006	171.8
Tennessee.....	16,500	0.008
Cockeysville, Md.....	16,000	175
Dorset, Vt.....	2.63	0.58	164.7
Tuckahoe, N. Y.....	13,600	2.80	175
Rutland, Vt.....	11,892	1202
Rutland, Vt.....	13,864	2057
De Kalb, N. Y.....	838

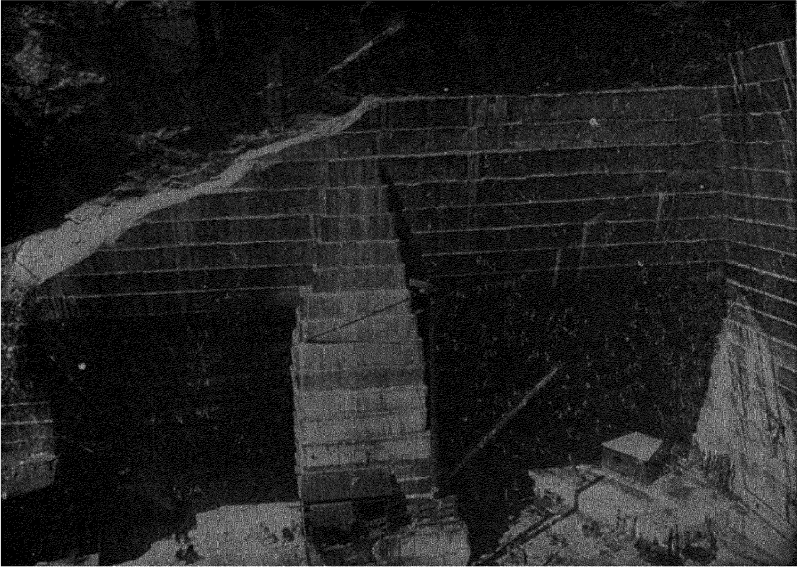

PLATE LXXI, FIG. 1. — Quarry of Vermont Marble Company, Proctor, Vt
(Photo loaned by Vermont Marble Company.)

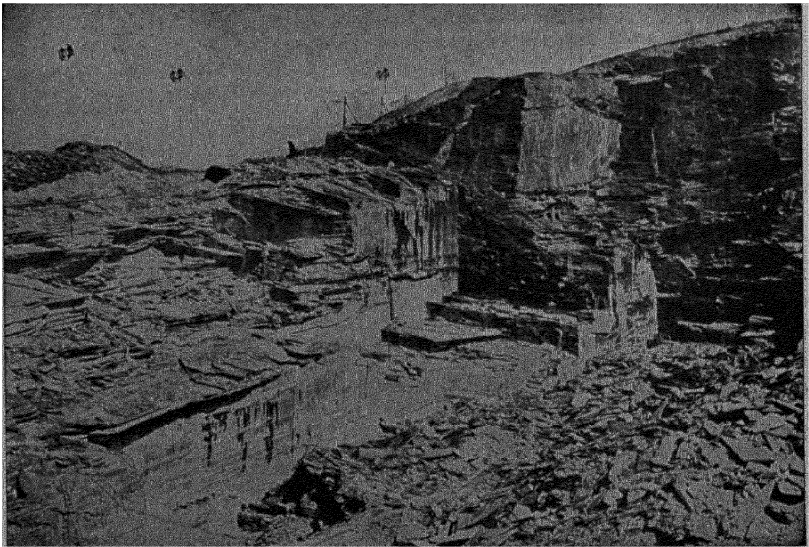

FIG. 2. — Slate quarry, Penrhyn, Pa. (From Ries' Economic Geology.)
(498)

Absorption. — The absorption of marbles is always low, usually under one per cent.

Crushing and transverse strength. — A few tests taken from different sources, and given below will give some indication of these and other properties of marbles.

Sonorousness. — The ring which a marble emits when struck with a hammer is to some extent indicative of its soundness. However, good marbles may vary somewhat in this respect.

Uses. — Marbles are being used in increasing quantities for ordinary structural work, although many of the lighter-colored ones soon become soiled by dust and smoke. They are also widely employed for decorative work, because of their beauty, susceptibility to polish and easy-working qualities. They are still widely used for monuments and shafts, especially in the rural districts, but are rapidly being replaced by granite.

Distribution of Marbles in the United States

One belt of marble extends from western Vermont (Ref. 70) southward into Alabama and this is an important one, for it supplies chiefly white and gray marbles which are quarried in Vermont, Pennsylvania, Maryland (Ref. 37), Georgia (Ref. 26) and Alabama. Pink and black marbles are locally known. Variegated marbles of siliceous character are obtained in northern Vermont, and pink and brown ones in eastern Tennessee (Ref. 64).

White ones are obtained in Colorado, and white and gray ones in California. Near Carthage, Mo., there is quarried a hard, dense, creamy-white limestone that is sometimes marketed as a marble, and takes a polish.

Onyx Marble

Under this term we can include two types of calcareous rock, the one a hot-spring deposit or travertine formed at the surface, the other a cold-water deposit formed in limestone caves, in a similar manner to stalactites and stalagmites. Neither type of deposit is extensive, and the stone is solely used for decorative work.

Serpentine

This rock is occasionally found in sufficiently massive form to be used for structural and decorative work; indeed the latter use is its main one. The main objection to it is the frequent and irregular jointing developed in practically all quarries, and its poor weathering qualities, for on exposure to weather it wears irregularly, cracks, loses

its lustre and fades in spots. The impurities that are often present in the stone are iron oxides, pyrite, hornblende, pyroxene and carbonates of lime and magnesia.

The colors of the rock are often very beautiful. Green and yellow predominate in the purer forms, while the more impure ones commonly exhibit various shades of black, red or brown (see Chapter II).

Serpentine deposits (Ref. 6) are known in Massachusetts, Vermont, New York, New Jersey, Pennsylvania, Maryland (Ref. 37), Georgia, California and Washington.

Ophicalcite or *ophiolite* is a spotted green and white variety, which consists of a white ground of calcite, and green spots of serpentine. It is not much used (see Chapter II).

Slates

Structural features.—Slates, as previously explained, are metamorphic rocks, derived usually from clay or shale and more rarely from very fine-grained igneous rocks (see Metamorphic Rocks).

Their commercial value depends primarily on the existence of a well-defined plane of splitting, called *cleavage*. This has been developed by metamorphism, through the rearrangement and flattening of the original mineral grains, and in the mica slates at least by the development of mica scales (see under Metamorphism).

During the process of metamorphism many of the stratification planes become sealed up, their position, however, being indicated by dark bands or ribbons. As a rule the slaty cleavage is not coincident with the bedding but may form any angle with it (Figs. 68 and 199).

The cleavability of different slates varies, some splitting evenly and smoothly into thin layers, while others do so with difficulty. Repeated freezing and thawing has a disastrous effect on the cleavability, so that the material should be split when fresh from the quarry and before it has a chance to dry out.

False cleavage and *slip cleavage* (Fig. 200) are terms applied to extremely minute plications seen on the cleavage surfaces, which are due to microscopic slips or faults along which the slate breaks easily.

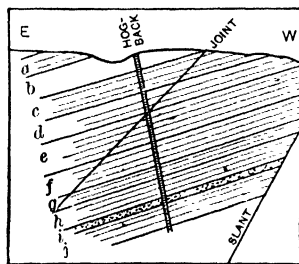

FIG. 199.—Section in slate quarry with cleavage parallel to bedding. *a*, purple slate; *b*, unworked; *c* and *d*, variegated; *e* and *f*, green; *g* and *h*, gray-green; *i*, quartzite; *j*, gray with black patches. (After Dale.)

The *grain* (Plate LXXII, Fig. 1) is a direction along which the slate can be split, but not as smoothly as along the true cleavage. It is indicated by a somewhat indistinct striation on the cleavage surface in a direction nearly parallel to the cleavage dip.

Joints (Plate LXXI, Fig. 2) are found in slate of all quarries and may traverse the rock in various directions. The term *post* is applied to a mass of slate traversed by so many closely-spaced joints as to be worthless.

Veins of calcite or quartz are not uncommon, and sometimes occupy the joint fissures. Their presence renders that portion of the slate in which they occur worthless.

Properties of slate. — Since slate differs in its occurrence, properties and uses from other building stones, its properties and the tests which can be applied to it need special reference.

Sonorousness. — A piece of roofing slate when struck usually emits a ring like vitreous china. The mica slates are more sonorous than

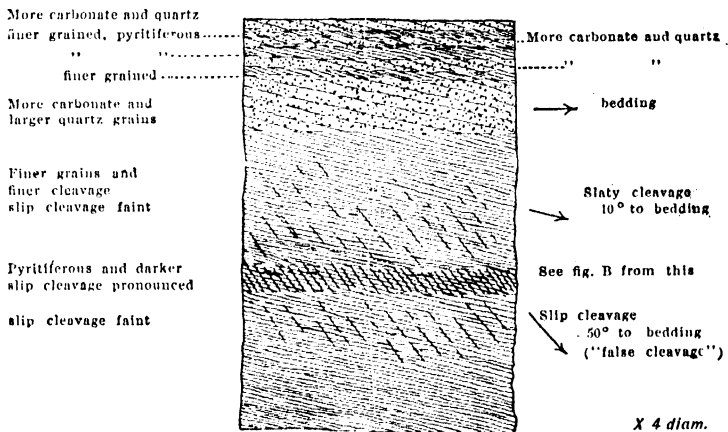

FIG. 200. — Section showing relation of cleavage, false cleavage and bedding. (After Dale.)

the clay slates; but those with considerable chlorite may be deficient in this respect.

Cleavability. — This property is tested by splitting the slate with a thin, broad-edged chisel, in order to determine the smoothness, thinness and regularity with which it cleaves.



PLATE LXXII, FIG. 1. — Sculpting slate. The slab has been broken along the grain, and as the one piece dropped, it broke along the cleavage. (H. Ries, photo.)



FIG. 2. — Splitting slate. (H. Ries, photo.)

Cross fracture (Sculping). — This property is tested to determine the character of the grain.

Color and discoloration. — The value of a roofing slate depends somewhat upon its permanence of color. Information on this point is best obtained by comparing a freshly-quarried piece with a weathered one that has lain on the dump for several years at least.

Strength. — It is important to determine the transverse strength of a slate. The modulus of rupture in the best slates ranges from 7000 to 10,000 pounds. An impact test is sometimes used instead of the regular transverse test. A simple one devised by Merriam consists in dropping a wooden ball of 15.7 ounces weight, from a height of 9 inches, on to a piece of slate 6 by $7\frac{3}{4}$ inches and 0.20 to 0.28 inches thick. The blows are repeated until the slate breaks. The foot-pounds of work per pound of slate can be calculated from the weight and thickness of the slate, and the number of blows.

Toughness or elasticity. — If a slab of slate is fastened between two supports and subjected to pressure it will bend slightly before breaking, the amount of deflection indicating the degree of toughness of the slate.

Abrasive resistance. — This is of importance where the slate is used in thick slabs for paving or stair treads, but there is no standard method for determining it.

Corrodibility. — Slates should resist exposure to acid atmospheres. They may be exposed to it either by moisture or rain water with acid flowing on the upper surface, or by such water being drawn up by capillarity between the slate slabs on the roof.

A method of testing this consists in using a solution of 98 parts of water, and 1 part each of hydrochloric and sulphuric acids. A weighed piece of slate is immersed in this for 120 hours, dried for 40 hours, weighed, the solution strengthened and the process repeated. The loss in weight indicates the degree to which it is corroded.

Mineral impurities. — Pyrite or marcasite, the sulphides of iron, are objectionable impurities, because they decompose to limonite and leave the slate pitted. Calcium carbonate is an undesirable constituent, since it is attacked by acids of the atmosphere. Clay is present in some slates, and such will emit an argillaceous odor if breathed upon, provided they contain much of it. Siderite or a mixture of dolomite and siderite is found in some slates, especially the sea-green ones of Vermont. Upon exposure to weather the iron carbonate changes to limonite, and there is a corresponding change in color of the slate from green to grayish-brown.

MERRIMAN'S TESTS ON SLATE.

Color and locality.	Modulus of rupture in pounds per square inch.		Ultimate deflec- tion in inches. Supports 22 inches apart.		Specific gravity.		Per cent absorp- tion in 24 hrs.		Amount in grams abraded by 50 turns of a small grindstone.		Per cent of weight lost in acid solu- tion in 63 hrs.	
	Max.	Aver.	Max.	Aver.	Max.	Aver.	Max.	Aver.	Max.	Aver.	Max.	Aver.
Blue, Chapman Quarries, Pa.	12,490	9460	0.24	0.212	2.78	2.76	0.29	0.23	0.234	0.208	0.560	0.383
Blue, William Slate Co., Arvonia, Va.	10,700	9040	0.31	0.227	2.79	2.78	0.20	0.14	0.067	0.06	0.801	0.394
Blue, A. L. Pitts, Arvonia, Va.	11,970	9850	0.25	0.225	2.80	2.79	0.33	0.21	0.159	0.108	0.552	0.323
Blue, Merrill Brownville Slate Co., Be, Marville, Me.	11,720	9880	0.22	0.20	2.80	2.79	0.18	0.14	0.360	0.265	0.366	0.305
Blue, Monson Cons. Slate Co., Monson, Me.	11,370	9130	0.24	0.20	2.79	2.79	0.20	0.18	0.302	0.256	0.384	0.286
Green; Vermont Unfading Green Slate Co., Fair Haven, Vt.	6,580	6410	0.26	0.22	2.78	2.77	0.30	0.23	0.356	0.341	0.313	0.295
Green; Rising & Nelson Slate Co., W. Pawlet, Vt.	11,040	7250	0.24	0.20	2.75	2.73	0.42	0.32	0.299	0.190	1.067	0.768
Green; Mathews Cons. Slate Co., Boston, Mass.	10,130	8050	0.22	0.19	2.78	2.78	0.40	0.37	0.286	0.226	0.428	0.379
Red; Mathews Cons. Slate Co., Boston, Mass.	11,340	9220	0.27	0.23	2.85	2.84	0.33	0.24	0.304	0.148	0.507	0.373

U. S. Geol. Survey, Bull. 275.

Tests of slate.—The table on p. 487 gives the properties of a number of slates.

Quarrying.—The waste in slate quarrying is very high, probably never under 60 per cent and not infrequently as high as 80 per cent. The utilization of the tremendous waste heaps is still an unsolved problem, but several possible uses have been suggested, viz.: (1) As a substitute for clay or shale in Portland cement; (2) as a mineral pigment when ground and mixed with oil; (3) as road material; (4) for brick manufacture; and (5) crushed as granules for roofing.¹

The salable material taken from the quarry may be used either for roofing purposes or millstock. The latter represents a more massive type, which is cut into slabs for tubs, sinks, table tops, switchboards, blackboards, stair treads, etc.

Classification of slates.—The following classification of slates has been suggested by Dale.

A. Clay slates.—Purple red of Penrhyn, Wales; black of Martinsburg, W. Va.

B. Mica slates:

1. Fading:

- (a) Carbonaceous or graphitic (blackish);
Lehigh & Northampton Counties, Pa.; Benson, Vt.
- (b) Chloritic (greenish);
"Sea green," Vermont.
- (c) Hematitic and chloritic (purplish);
Purplish of Pawlet and Poultney, Vt.

2. Unfading:

- (a) Graphitic;
Peachbottom of Pa. and Md.; Arvonnia, Va.; Northfield, Vt.; Brownville, Monson, Me.; North Blanchard, Me.; West Monson, Me.
- (b) Hematitic (reddish);
Granville, Hampton, N. Y.; Polk County, Ark.
- (c) Chloritic (greenish);
"Unfading green," Vermont.
- (d) Hematitic and chloritic (purplish);
Purplish of Fair Haven, Vt.; Thurston, Md.

Distribution of Slates in the United States

Since slates are of metamorphic origin, they, like true marbles, are limited to those regions (Plate LXXIII) in which the rocks are metamorphosed, due to mountain-making movements as explained on p. 208.

¹ Stone, Pa. Top. and Geol. Surv., Bull. 82, 1923.

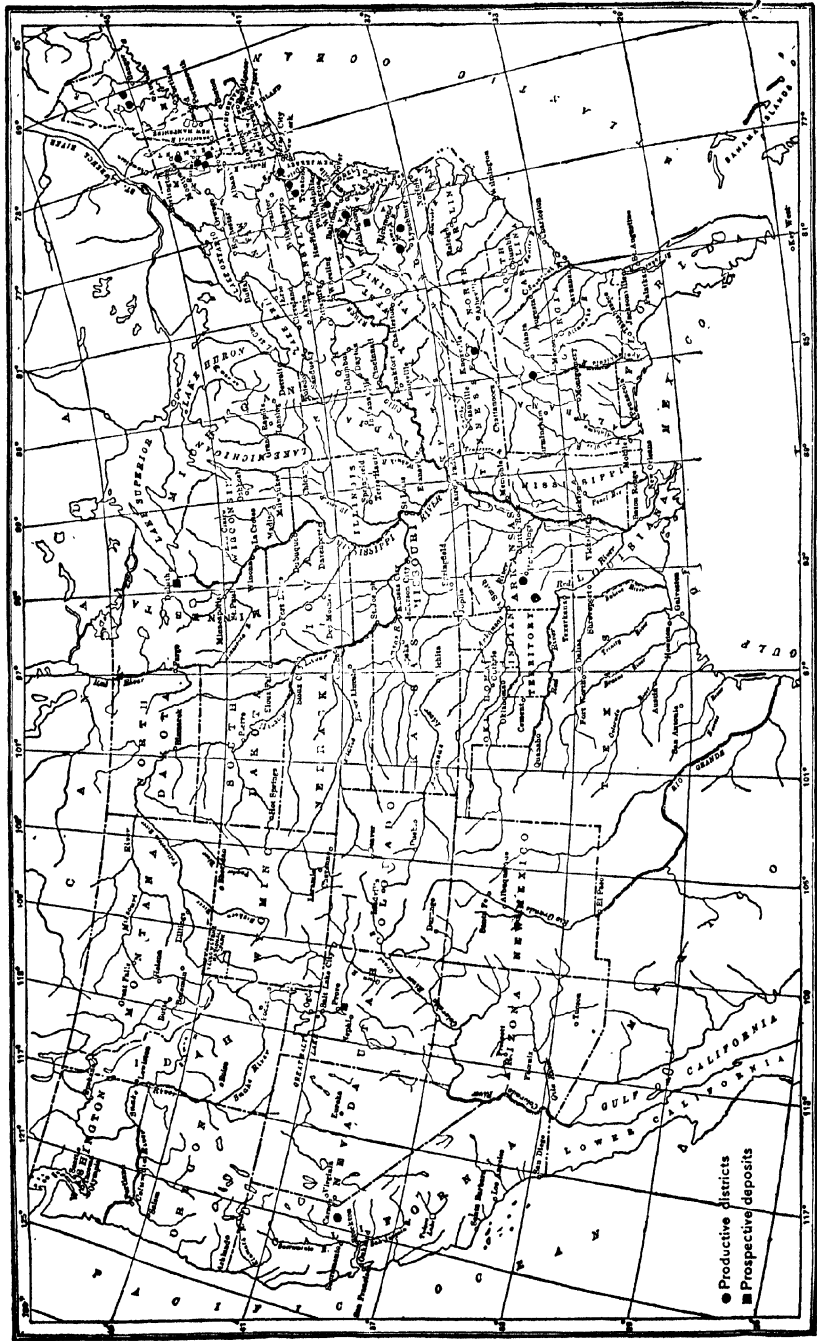

PLATE LXXIII. — Map showing slate-producing districts of the United States. (After Dale, U. S. Geol. Survey, Bull. 275.) (506)

At present the greater part of our supply comes from the Cambrian and Silurian horizons of the Atlantic states (Ref. 69). The slates from this area are chiefly grayish-black, but that portion of the belt lying on the border between New York and Vermont also supplies red, green and purple slate. Other producing states are California, Arkansas and Minnesota.

References on Building Stone

General works. — 1. Bowles, Bur. Mines, Inf. Circ. 6313, 1930 (Marble, general). 1a. Bowles, *Ibid.*, Bull. 124, 1917 (Sandstone quarrying). 1b. Bowles, *Ibid.*, Bull. 218, 1922 (Slate technology). 1c. Brown, W. M., *Stone*, June, 1908 (Preservation methods). — 2. Davies, D. C., *Slate and Slate Quarrying*, London, 1899 (Crosby, Lockwood & Son). — 3. Forster, C. L., *Elements of Mining and Quarrying*, London, 1903 (Griffin & Co.). — 3a. Gardner, Univ. State, N. Y., Dept. Ed. Pub., 1919 (Effect acid atmosphere on marble). — 3b. Heaton, Quarry, Surveyors and Contractors Jour., XXVII, p. 56, 1922 (Stone preservation). — 4. Hirshwald, *Handbuch der bautechnischen Gesteinsprüfung*, Berlin, 1912 (Gebrüder Bornträger). — 4a. Howe, *Geology of Building Stones* (London, 1910). — 5. Humphreys, U. S. Geol. Surv., Bull. 370, 1909 (Fire tests). — 6. Merrill, G. P., *Stones for Building and Decoration*, New York (Wiley & Sons). — 7. McCourt, W. E., N. Y. State Museum, Bull. 100, 1906, and N. J. Geol. Surv., Ann. Rept., 1906 (Fire tests). — 8. Renwick, W. G., *Marble and Marble Working*, London, 1909 (Lockwood, Crosby & Son). — 9. Ries, H., *Building Stones and Clay Products*, New York, 1912 (Wiley & Sons). — 10. Seipp, H., *Wetterbeständigkeit der natürlichen Bausteine*, Jena, 1900 (H. Costenoble). — 10a. Tarr, *Econ. Geol.*, X, p. 348, 1915 (Heating tests).

Serials. — 11. *Stone*, a monthly magazine published in New York City. — 12. *Baumaterialenkunde*, published by Stahle u. Friedel, Stuttgart.

Areal reports. — *Alabama.* 13. Prouty, Ala. Geol. Surv., Bull. 18, 1916 (Marbles). 14. Watson, U. S. Geol. Surv., Bull. 426, 1910 (Granites). — *Alaska.* 15. Wright, U. S. Geol. Surv., Bull. 345, 1908, and Burchard, Bull. 682, 1920. — *Arizona.* 16. Anon, *Stone*, Aug., 1911 (Marble). — *Arkansas.* 17. Hopkins, Ark. Geol. Surv., Ann. Rept. 1890, IV, 1893 (Marbles). 18. Purdue, Ark. Geol. Surv., 1909 (Slate). 19. Williams, J. F., Ark. Geol. Surv., Ann. Rept., 1890, II, 1891 (Igneous rocks). — *California.* 20. Aubury and others, Calif.

State Min. Bur., Bull. 38, 1906 (General.) 21. Eckel, U. S. Geol. Surv., Bull. 225, p. 417, 1904 (Slate). 22. Dale, U. S. Geol. Surv., Bull. 586, 1914 (Slate). — *Colorado*. 23. Lakes, Mines and Minerals, XXII, pp. 29 and 62, 1901. 24. Anon, Stone, XI, p. 213, 1895. — *Connecticut*. 25. Dale, U. S. Geol. Surv., Bull. 738, 1923 (Granites). — *Georgia*. 26. McCallie, Ga. Geol. Surv., Bull. 1, 2nd ed., 1904 (Marbles). 27. Watson, Ga. Geol. Surv., Bull. 9A, 1903 (Granites and gneisses). 28. Watson, U. S. Geol. Surv., Bull. 426, 1910 (Granites). 29. Dale, U. S. Geol. Surv., Bull. 586, 1914 (Slate). — *Indiana*. 30. Hopkins, Ind. Geol. and Nat. Hist. Surv., 20th Ann. Rept., p. 188, 1896. 31. Loughlin, U. S. Geol. Surv., Bull. 811-C, 1929 (Bedford limestone); also Ind. Geol. and Nat. Hist. Surv., 32nd Ann. Rept., p. 321, 1907 (Limestone). 32. Thompson, Ind. Geol. and Nat. Hist. Surv., 17th Ann. Rept., p. 19, 1891 (General). — *Iowa*. 33. Beyer, Williams and Marston, Ia. Geol. Surv., XVII, pp. 54 and 185, 1907. — *Kentucky*. 34. Crump, Ky. Geol. Surv., 4th ser., I, p. 1037 (Bowling Green limestone). — *Maine*. 35. Dale, U. S. Geol. Surv., Bull. 738, 1923 (Granite). 36. Dale, U. S. Geol. Surv., 586, 1914 (Slate). — *Maryland*. 37. Matthews, Md. Geol. Surv., II, p. 125, 1898 (General). 38. Watson, U. S. Geol. Surv., Bull. 426, 1910 (Granites). 39. Dale, *Ibid.*, Bull. 586, 1914 (Slate). — *Massachusetts*. 40. Dale, U. S. Geol. Surv., Bull. 738, 1923 (Granites). — *Michigan*. 41. Benedict, Stone, XVII, p. 153 (Bayport district). — *Minnesota*. 42. Bowles, U. S. Geol. Surv., Bull. 665, 1918 (General). — *Missouri*. 43. Buckley and Buehler, Mo. Bur. Geol. and Mines, II, 1904 (General). — *Montana*. 44. Rowe, Univ. of Mont., Bull. 50 (General). — *New Hampshire*. 45. Dale, U. S. Geol. Surv., Bull. 738, 1923 (Granites). — *New Jersey*. 46. Lewis, N. J. Geol. Surv., Ann. Rept. 1908, p. 53, 1909 (General). — *New York*. 47. Dale, U. S. Geol. Surv., Bull. 586, 1914 (Slate). 48. Dickinson, N. Y. State Museum, Bull. 61, 1903 (Bluestone). 49. Newland, Bull. 181 (General). — *North Carolina*. 50. Watson, U. S. Geol. Surv., Bull. 426, 1910 (Granites). 51. Watson, Lancy and Merrill, N. C. Geol. Surv., Bull. 2, 1906 (General). — *Ohio*. 52. Orton, Ohio Geol. Surv., V, p. 578, 1884. 53. Orton and Peppel, *Ibid.*, 4th ser., Bull. 4, 1906 (Limestones). — *Oklahoma*. 54. Gould and Taylor, Okla. Geol. Surv., Bull. 5, 1911 (General). — *Oregon*. 55. Parks, Min. Res. Ore., I, No. 2, 1914. — *Pennsylvania*. 56. Hopkins, Penn. State College, Ann. Rept., 1895. — *Appendix*, 1897; also U. S. Geol. Surv., 18th Ann. Rept., V, p. 1025, 1897 (Brownstones). 57. Dale, U. S. Geol. Surv., Bull. 586, 1914 (Slate). — *Rhode Island*. 58. Dale, U. S. Geol. Surv., Bull. 738, 1923 (Granites). — *South Carolina*. 59. Sloan, S. C.

Geol. Surv., Ser. IV, Bull. 2, p. 162, 1908. 60. Watson, U. S. Geol. Surv., Bull. 426, 1910 (Granites). — *South Dakota*. 61. Todd, S. Dak. Geol. Surv., Bull. 3, p. 81, 1902. — *Tennessee*. 62. Gordon, Dale and Bowles, Tenn. Geol. Surv., Bull. 28, 1924 (Marbles). 63. See also G. P. Merrill's book mentioned above. 64. Gordon, C. H., *Ibid.*, Bull. 2D, 1911. — *Texas*. 65. Nash. Univ. Tex. Bull. 1725, 1917: — *Vermont*. 66. Dale, U. S. Geol. Surv., Bull. 738, 1923 (Granites). 67. Perkins, Report of State Geologist on Mineral Industries of Vermont, 1899-1900, 1903-1904, 1907-1908, and Report on Marble, Slate and Granite Industries, 1898. 68. Ries, U. S. Geol. Surv., 18th Ann. Rept. (Marbles). 69. Dale, U. S. Geol. Surv., Bull. 586, 1914 (Slate). 70. *Ibid.*, Bull. 521, 1912 (Marbles). 71. Bristol, Rept. State Geologist, 1911-12 (High-tension testing slate and marble). 72. Baker and Davidson, *Ibid.* (Strength and weathering qualities slate). — *Virginia*. 73. Watson, Min. Res. of Va., Lynchburg, 1907 (General), and U. S. Geol. Surv., Bull. 426, 1910 (Granites). 74. Dale, U. S. Geol. Surv., Bull. 586, 1914 (Slate). — *Washington*. 75. Shedd, Wash. Geol. Surv., II, 1902 (General). — *West Virginia*. 76. Dale, U. S. Geol. Surv., Bull. 586, 1914 (Slate). 77. Grimsley, W. Va., Geol. Surv., III, 1905 (Limestones), and IV, p. 355, 1909 (Sandstones). — *Wisconsin*. 78. Buckley, Wis. Geol. and Nat. Hist. Surv., Bull. IV, 1898 (General). — *Wyoming*. 79. Knight, Eng. & Min. Jour., LXVI, p. 546, 1898. — *Canada*. 83. Parks, Can. Dept. Mines, Building Stones Canada, Pts. I, II, III, IV, V. (Que., Ont., N. S., N. B., Prairie Provinces, Brit. Col.)

CHAPTER XIII

LIMES, CEMENTS, AND PLASTER

Limes and Calcareous Cements

The limes and calcareous cements form an important class of economic products obtained from limestones of varying composition by heating them to different temperatures. The limes are produced from limestones low in clayey impurities; the cements from limestones high in clayey substances. In the burning of the former calcium oxide is formed, in the latter complex silicates and aluminates.

Composition of limestones. — The subjoined table gives a sufficient number of analyses to indicate how these rocks vary in their composition.

ANALYSES OF LIMESTONE

	I.	II.	III.	IV.	V.	VI.	VII.	VIII.	IX.	X.	XI.
SiO ₂72	0.06	3 83	0 08	5 5	7 60	6 22	28 72	15 37
Al ₂ O ₃				0.80	2 31	0 25	1 3	0 75	1 70	12 28	9 13
Fe ₂ O ₃			1.5						0 86	5 22	2 25
CaO	56 00	30 44	54 28	55 00	52 16	30 46	28 2	50 05	47 86	25 54	25 50
MgO		21 73	0 8		0 14	21 48	20 2	0 30	0 04	1 10	12 35
CO ₂	44 00	47 83	44 0	43 22	41 64	47 58	44 3	41 30	42 11	24 40	34 20
H ₂ O					0 20						1 20
SO ₃				0 05	0 20					1 53	n.d.
Total.	100 00	100 00	101 30	99 13	100 28	99 85	99 5	100 00	100 99	98 79	100 00

I. Calcite; II. Dolomite; III. Pure limestone, Smith's Basin, N. Y.; IV. Bog lime, Newaygo, Mich; V. Chalk, Western P. C. Co., Yankton, S. D; VI. Dolomite, Canaan, Conn; VII. Magnesian limestone, Oxford Furnace, Sussex County, N. J.; VIII. Hydraulic limestone, Malain, France; IX. Impure bog lime, Montezuma, N. Y.; X. Natural cement rock, Cumberland, Md.; XI. Natural cement rock, Rondout.

From this table it will be seen that limestones range from rocks composed almost entirely of calcium carbonate or of calcium and magnesium carbonates, to others which are high in clayey and siliceous impurities. The presence of such impurities not only gives the rock an earthy appearance, but at times even a shaly structure.

It must not be assumed, however, that even marked differences in chemical composition can always be detected with the naked eye, for in many cases they cannot. If then it is necessary to sample a quarry for analysis, it should be done thoroughly and systematically.

Changes in burning. — If a limestone is calcined to a temperature of 900° C. it loses all of its carbon dioxide, as shown by the following equation:

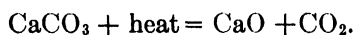

This is the temperature of decarbonation, and the rock after heating to this point is porous and if low in impurities will slake when mixed with water. Heated still higher the rock will clinker or fuse incipiently, provided there are clayey impurities present. Moreover, the temperature of clinkering depends on the amount and nature of these impurities. The presence of such clayey impurities not only interferes with the slaking qualities of the burned product, but is responsible for the property of setting to a hard mass when the properly-burned material is ground and mixed with water. This latter type of product represents hydraulic cement.

Lime

Limestone free from or containing but a small percentage of clayey impurities is by decarbonation changed to quicklime, a substance which has a high affinity for water, and which, when mixed with it slakes, forming a hydrate of lime. Thus:

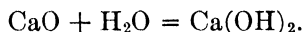

The heat required for burning the lime depends somewhat on the character of the stone, but decarbonation takes place at about 900° C. and the stone may be heated as high as about 1200° C., although at this temperature impurities if present cause incipient vitrification on the outside of the lump and retard slaking. Since some vitrification may occur even below this temperature the lower the heat at which the lime is burned the better. The presence of steam in the kiln lowers the decarbonation temperature to 790° C., and for this reason wood gives better lime than coal, because it contains more moisture which changes to steam in the kiln.

The classification of limes adopted by the National Lime Manufacturers' Association is as follows:

	Per cent of Magnesia
High-calcium lime.....	0-5
Magnesian lime.....	5-25
Dolomitic lime.....	25-45
Super-dolomitic lime.....	over 45

Lime in slaking, as said before, combines chemically with the water, this reaction being accompanied by the generation of heat and an increase in volume. Slaked lime sets on exposure to the air, due to the evaporation of the excess of water, and the reversion of the calcium

hydrate to calcium carbonate by absorption of carbon dioxide from the atmosphere. Thus:

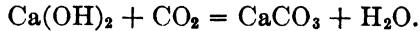

Dolomitic limes will in general slake more slowly, take up less water, generate less heat, expand less, set more slowly and shrink less than high-calcium limes. An underburned calcite lime resembles a dolomitic lime in some respects. An overburned lime reacts more slowly than a normally-burned one.

Magnesian limes work more smoothly, but set more slowly than high-calcium limes, as well as being stronger. But, after all, experience in mixing plays an important rôle in the production of successful results.

Hydrated lime is a product prepared by adding just enough water to accomplish complete slaking, the heat generated evaporating the excess of water and leaving the product dry. It consists of calcium hydrate and magnesium oxide (if the latter is present). It usually saves the time required for slaking.

Hydraulic or Silicate Cements

With an increase in clayey and siliceous impurities, the burned rock shows a decrease in its slaking qualities and develops hydraulic properties, or sets when ground and mixed with water. This product is the hydraulic cement, whose setting properties are due to the formation of new compounds during manufacture or when mixed with water. The new compounds formed in burning are probably solid solutions of aluminates and silicates of lime.

Hydraulic cements can be divided into the following classes: Hydraulic limes, natural cements, Portland cements, Puzzolan cements and high alumina cement. These four classes differ in regard to the raw materials used, method of manufacture and properties of the finished product.

Hydraulic Limes

These are formed by burning a siliceous or argillaceous limestone to a temperature not much above that of decarbonation. Owing to the high percentage of calcium carbonate in the rock, considerable free lime appears in the finished product.

The burned product, therefore, not only has hydraulic properties, but it will also slake on the addition of water. As a result of the latter property it is self-pulverizing, because the swelling incident to slaking disintegrates the mass.

The following analyses give the composition of some limestones used for making hydraulic lime.

ANALYSES OF HYDRAULIC LIMESTONE

	I.	II.	III.	IV.
SiO ₂	14.30	11.03	7.60	17.00
Al ₂ O ₃	0.70	3.75	0.75	1.00
Fe ₂ O ₃	0.80	5.07
CaO.....	46.50	43.02	50.05	44.80
MgO.....	undet.	1.34	0.30	0.71
CO ₂ {	36.54	35.27	41.30	35.99
H ₂ O {

I. Teil, France. II. Hausbergen, Germany. III. Malain, France. IV. Senonches, France.

In the best types of hydraulic limestones, silica varies between 13 and 17 per cent, while alumina and iron oxide together rarely exceed 3 per cent.

Hydraulic limes generally have a yellow color, a specific gravity of about 2.9, and slake and set slowly, but have little strength unless mixed with sand. They are of little importance in the United States, although small quantities have in the last few years been produced in Maryland, Georgia, and New York. They are, however, of much importance in Europe.

The following table gives the composition of: (I) A hydraulic limestone, (II) hydraulic lime, before slaking, and (III) hydraulic lime after slaking.

ANALYSES OF HYDRAULIC LIME

	I.	II.	III.
SiO ₂	13.20	21.20	19.08
CaO.....	86.80 }	78.80	70.92
CO ₂		0.00	0.00
H ₂ O.....	0.00	0.00	10.00

Grappier cement is a product obtained by finely grinding lumps of underburned and overburned material. It may approximate Portland cement in its properties, provided it contains enough lime silicate. *Lafarge* cement, known also as a "non-staining" cement, is of the grappier type.

Feebly hydraulic limes include products whose cementation index ranges between 0.30 and 0.70. They contain considerable free lime and are of low strength, but are used in England.

They also form the basis of *Selenitic lime* or *Scott's cement*, which is made of a mixture of hydraulic lime and plaster of Paris. These cements show a higher strength than the hydraulic lime proper.

Natural Cements

These are made from a clayey limestone containing from 15 to 40 per cent of clayey impurities, by burning it at a temperature of dull redness, or just high enough to cause some incipient fusion.

They show a variable and sometimes high percentage of magnesia, which is not considered injurious as in Portland cement materials.

The following analyses give the composition of natural cement rocks from a number of localities.

ANALYSES OF NATURAL CEMENT ROCKS

	I.	II.	III.	IV.	V.	VI.	VII.	VIII.	IX.
SiO ₂	14 15	15 21	21 80	24 74	12 14	18 52	10 66	18 34	17 56
Al ₂ O ₃	6 37	4 07	3 70	16 74	4 62	6 34	4 35	7 49	1 41
Fe ₂ O ₃	2 35	1 44	3 10	6 30	1 84	2 63	1 47	3 60	3 03
CaO.....	26 32	33 99	35.00	23 41	22 66	25 31	27 20	37 60	25 50
MgO.....	12.10	7 57	3.50	4 09	16 84	12 13	16 77	1 38	15 45
Na ₂ O, K ₂ O.....	0 18	6 13	3 52	undet.
SO ₃	1 81	2 22	0 13	0 90
CO ₂	34 70	35.03	33 00	22 90	39.07	33 31	38 81	31 06	37 05
H ₂ O.....	2 03	undet.	1 53	3 94
Cementation index.....	1 11	1.68	3 15	0 88	1.43	0.71	1 49

I. Utica, Ill.; II. Louisville, Ky., district; III. Fort Scott, Kas.; IV. Cumberland, Md.; V. Mankato, Minn.; VI. Rosendale, N. Y.; VII. Central New York; VIII. Copley, Pa.; IX. Milwaukee, Wis.

Natural cements then are made from the natural rock. After burning and grinding they are usually yellow to brown in color, and have a specific gravity of 2.7 to 3.1. They set rapidly and do not develop as high a tensile strength as the Portlands.

Argillaceous limestones suited to natural-cement manufacture are widely distributed, and occur interstratified with other clayey and calcareous rocks which may have no hydraulic value. Owing to the low price of natural cement, the material must be exceptionally well located to be workable, and such deposits are few in number. But aside from this the consumption has been decreasing in recent years, because Portland cement is regarded as more desirable.

Portland Cement

Portland cement is the product obtained by burning to incipient fusion a finely-ground artificial mixture, consisting essentially of lime, silica, alumina and some iron oxide, these substances being present in definite proportions. The finely-ground burned product is the cement.

The combinations of raw materials used in the United States are:

Marl (bog-lime) and clay; limestone and clay or shale; chalk and clay; high-calcium limestone and argillaceous limestone (natural-cement rock).

The ratio of lime to silica, alumina and iron oxide combined in the finished cement will be not less than 1.6 to 1 or more than 2.3 to 1 (Eckel).

Raw materials used.—*Clay.*—The clay (or shale) used in Portland-cement manufacture is usually of the transported type and, therefore, often somewhat impure. It should be as free as possible from gravel and sand, calcareous fragments, or gypsum and pyrite nodules. The silica should be not less than 55 per cent, and preferably from 60 to 70 per cent. The ratio of $(Al_2O_3 + Fe_2O_3)$ to SiO_2 should be about 1 : 3. Magnesia and alkalis should not exceed 3 per cent if possible.

The clays employed are either non-calcareous or calcareous. Fire clays are undesirable, because: (1) On account of their high-alumina content they produce a very quick-setting cement, and (2) on account of their low percentage of fluxing impurities the vitrification temperature of the clinker becomes too high for practical operating purposes (Bleiningger). Number 2 fire clays¹ can be used if no others are available.

The hardness of the clay affects the expense of grinding, and its texture and uniformity affect the uniformity of the mixture.

White-burning residual clays are sometimes used for making white cement, but slate is rarely employed in Portland cement manufacture.

The following analyses give the composition of some of the argillaceous materials employed.

ANALYSES OF CLAYS USED IN PORTLAND CEMENT MANUFACTURE

	I.	II.	III.	IV.	V.	VI.	VII.
SiO_2	53.21	74.29	61.92	55.27	39.23	61.15	58.20
Al_2O_3	15.91	12.06	16.58	10.20	12.13	18.47	18.83
Fe_2O_3	7.25	4.92	7.84	3.40	2.79	5.05	5.78
CaO	1.89	0.41	2.01	9.12	21.61	0.98	4.35
MgO	0.99	0.68	1.58	5.73	2.69	2.26	3.51
Na_2O, K_2O	2.21	2.56	3.64	undet.	1.69	undet.	3.20
SO_2	0.97	undet.	tr.	undet.	undet.	0.91	0.49*
CO_2	undet.	undet.	undet.	undet.			0.60
H_2O	17.21	undet.	undet.	undet.	19.84	7.02	4.07
	99.64	94.92	93.57	83.72	99.98	93.84	99.03
$SiO_2 \rightarrow$ $Al_2O_3 + Fe_2O_3$	2.29	4.39	2.53	4.06	2.63	2.6	2.36

I. Pacific Portland Cement Co., Suisun, Calif., (Eckel); II. Bedford, Ind.; III. Smith's Landing, N. Y. (Eckel); IV. Syracuse, Ind.; V. Owen Sound, Ontario, Can.; 1 to 5. Are clays; VI. Shale, Coldwater, Mich; VII. Slate, Rockmart, Ga.

* Sulphur.

¹ Those fusing about cone 27, but still the term is rather loosely used.

Limestone. — The limestones used in Portland cement manufacture vary in hardness, texture, and chemical composition.

The following tabulation is given by Eckel to show the variation in lime rocks, and their possible gradation into clay rocks.

Material.	Hard.	Soft.	Unconsolidated.
Calcareous (CaCO ₃ over 75 per cent)	Pure hard limestone	Pure, soft, limestone or chalk	Pure bog-lime (incorrectly termed marl)
Argillo-calcareous (CaCO ₃ , 40 to 75 per cent)	Hard clayey limestone (cement rock)	Soft limestone or clayey chalk	Marl (often called clayey marl)
Argillaceous (CaCO ₃ , less than 40 per cent)	Slate	Shale	Clay

It will be seen from the above that no hard line of separation exists between adjoining members, and those of the lowest division are given to show the possible transition of the lime rocks into the clay rocks.

All of the lime rocks are comparatively fine-grained in texture, except some of the fossiliferous chalks and hard limestones, and some of the crystalline limestones.

The substances which may be regarded as undesirable impurities either under all or certain conditions are magnesia, silica, iron, alkalis and sulphur.

Magnesia is regarded by many as an inert or harmful constituent, and should be so low, that the MgO content of the finished cement will not exceed 3 per cent. Since the magnesia hydrates more slowly than the lime, dolomitic Portlands show two periods of hydration.

Silica, if present in a finely-divided form, either free or combined, and in the proper quantity to bring the silica, alumina-iron ratio within the proper limits, does no harm. If, however, it is in the form of chert concretions (Plate XIII, Fig. 2), the silica does not flux easily with the lime, and such limestones should be avoided. Coarse grains of silicates such as are found in marbles are likewise undesirable.

Iron in the form of pyrite should be avoided if present in amounts of over 2 or 3 per cent.

The sulphur may also be combined with calcium in the form of gypsum. In either case over 1½ per cent of sulphur is not wanted.

Sulphur compounds are undesirable for two reasons, viz.: (1) They form compounds of lower oxidation, which will on hydration of the cement, oxidize to sulphates with an increase in volume; (2) if oxidized in the kiln the sulphur may take lime away from the silica.

It is important to remember that the composition of a limestone

cannot be judged from its appearance, and before utilizing a deposit of lime rock for Portland cement manufacture careful analyses should be made of the fresh rock from the different beds in the deposit. Before opening a quarry the areal extent of the beds should be determined and should be carefully sampled at close intervals for analysis, especially in regions like the eastern Great Valley, where beds of high-calcium rocks grade frequently and rapidly into high-magnesium beds.

Marl deposits often contain irregular streaks of muck or peaty matter.

The cement. — Finely-ground Portland cement is blue to gray in color, and has a specific gravity of from 3 to 3.25. It is stronger than natural cement and sets more slowly.

Calculation of Portland cement mixture. — Given a clay and limestone of known composition, we can calculate with the aid of the cementation index, the number of parts of each that will be required as follows:

Operation I. — Multiply the percentage of silica in the clayey material by 2.8, the percentage of alumina by 1.1, and the percentage of iron oxide by 0.7. Add the products. Subtract from the sum thus obtained the percentage of calcium oxide in the clayey material, plus 1.4 times the percentage of magnesia and call the result n .

Operation II. — Multiply the percentage of silica in the calcareous material by 2.8, the percentage of alumina by 1.1, and the percentage of iron oxide by 0.7. Add the products and subtract the sum from the percentage of calcium oxide plus 1.4 times the percentage of magnesia in the calcareous material, calling the result m .

Operation III. — $\frac{n}{m}$ = parts of limestone to be used for each part of clay by weight.

For safety the amount of limestone required should be reduced by about 10 per cent.

Burning changes in cements. — Natural-cement rock is burned in a vertical kiln, similar to that used for burning lime. The chemically-combined water passes off at about 500° or 600° C.; the carbon dioxide about 800° or 900° C., or if magnesium carbonate is present, some decarbonation occurs at a lower temperature. Combination between the lime or magnesia and clayey impurities probably begins as low as 1000° C.

Portland cement mixtures are now usually burned in rotary kilns, at a much higher temperature than natural cement.

The chemical changes are complex, and probably only partly understood.

There have been several views expressed regarding the cause of setting. A plausible theory is that the basic calcium silicate is decomposed, setting free lime hydrate, forming possibly a monocalcium silicate and some colloidal products.

Economic considerations. — In determining the value of a deposit for Portland cement manufacture, a number of factors have to be considered, such as: (1) Chemical composition of the material; (2) physical characters; (3) quantity of rock available; and (4) location of deposit with respect to (a) transportation routes, (b) fuel supplies, and (c) market. The first of these has already been referred to. The second affects the cost of quarrying and crushing.

With regard to the third, it has been calculated that a plant running on dry material, such as limestone and shale, will use approximately 20,000 tons of raw material per year per kiln. Of this about 15,000 tons are limestone and 5000 tons are shale or their equivalents (bog lime and clay, etc.). If the limestone is taken at 160 pounds per cubic foot, one kiln will require about 190,000 cubic feet of limestone per year. Chalk may run as low as 110 pounds per cubic foot. Eckel states that a cubic yard of bog lime in the lake yields 900 pounds of dry bog lime.

Assuming the clay to run about 125 pounds per cubic foot dry, each kiln will take about 80,000 cubic feet per year. Shale weighs about 140 pounds per cubic foot.

Eckel states that for each kiln of a proposed plant there should be in sight at least 3,800,000 cubic feet of limestone and 1,600,000 cubic feet of clay or shale (Ref. 1).

Puzzolan Cements

This term in its broadest sense includes all natural or artificial materials, which when mixed with lime, yield a hydraulic cement without the aid of heat. The most important type made from natural materials is a mixture of volcanic ash and lime. An important type made from artificial materials, and of greater importance commercially is the *slag cement*, which consists of a mixture of blast-furnace slag and lime, both of which are finely pulverized before, during and after the mixing. There are several factories in the United States making slag cement, but none making the natural puzzolan.

The following table gives the composition of some volcanic ash deposits and slag used in this type of cement.

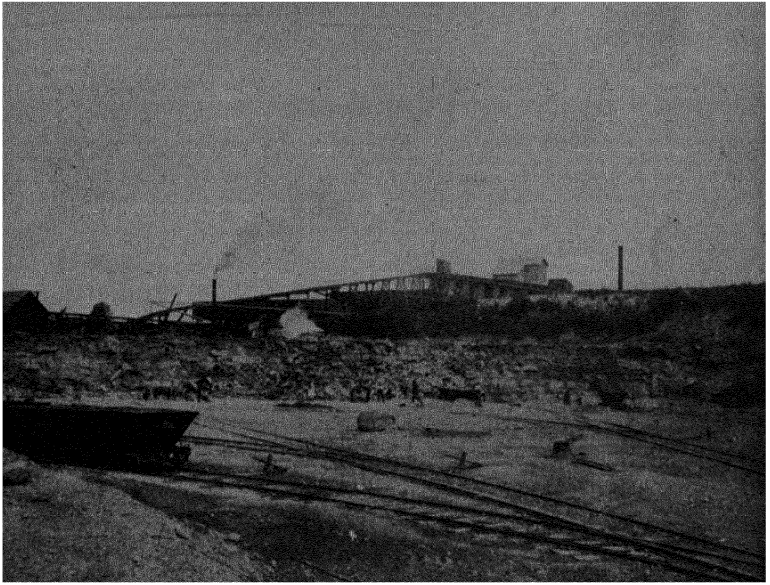

PLATE LXXIV, FIG. 1. — Quarry in natural cement rock, Milwaukee, Wis.
(H. Ries, photo.)

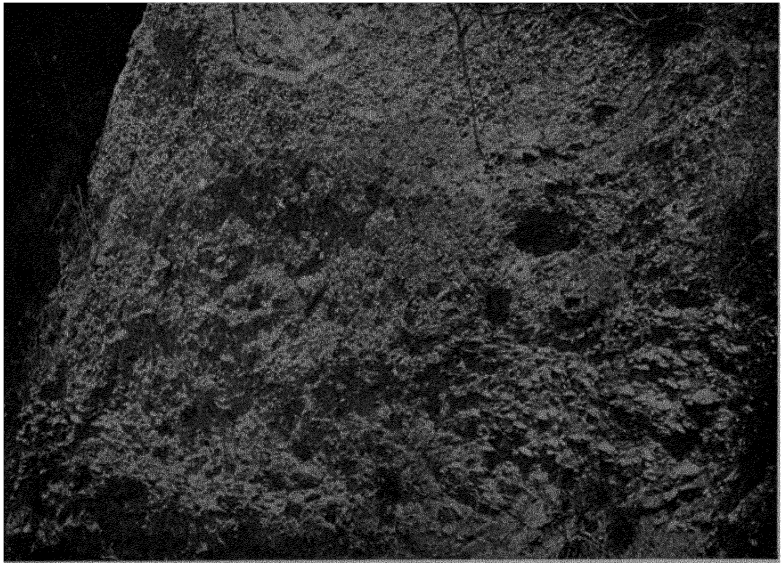

FIG. 2. — Shell marl outcrop along James River, Va. Used in Portland cement
manufacture. (T. L. Watson, photo.)

ANALYSES OF VOLCANIC ASH AND SLAG

	I.	II.	III.	IV.	V.	VI.
SiO ₂	44.5	56.31	47.9	46.25	51.08	34.30
Al ₂ O ₃	15.0	15.23	34.2	20.71	16.30	14.76
Fe ₂ O ₃	12.0	7.11				
CaO.....	8.8	1.74	8.2	2.15	5.46	48.11
MgO.....	4.7	1.36	3.9	1.00	1.50	2.66
K ₂ O.....	1.4	6.54	2.6	6.30	6.21
Na ₂ O.....	4.9	2.84				
H ₂ O.....	9.2	6.12	3.2	9.25	7.64

I. Puzzolana, Civita Vecchia, Italy; II. Tuff, Monte Nuova; III. Puzzolana, Auvergne Mountains, France; IV. Trass, Rhine district, Germany; V. Average of 31 analyses of Puzzolan material; VI. Slag, Chicago, Ill., $\frac{\text{CaO}}{\text{SiO}_2} = 1.40$; $\frac{\text{Al}_2\text{O}_3}{\text{SiO}_2} = .43$.

Slag cements differ from Portland cements in their lighter color (bluish-white to lilac), lower specific gravity (2.7–2.9), and slower set. They do not always show sufficient strength to pass the Portland specifications. They are also noticeably deficient in abrasive resistance.

The production of slag cement in the United States has shown a falling off in recent years.

Cement tests. — The tests which are usually applied to natural, Portland and slag cements are those to determine: (1) Fineness; (2) specific gravity; (3) soundness; (4) time of setting; and (5) tensile strength both alone (neat) and mixed with sand (mortar.)

High Alumina Cement

This cement, which is a French product, is a lime aluminate made by actually fusing a mixture of limestone and bauxite with coke in a furnace. The slag is ground and has an approximate composition of CaO, 50 per cent; Al₂O₃, 40 per cent; SiO₂, etc., 10 per cent. The cement is lower in lime than true Portland, its color is almost white, and it hardens so rapidly as to make a good heavy gun platform within 24 hours. It is also said to be more resistant to sea water than ordinary Portland.¹

Cementation Index

The *cementation index* is a formula used to express quantitatively the relation between the composition and hydraulic value of a cementing material. It cannot, however, be employed as the sole basis of classification, since the properties of a cement depend both on its

¹ Eckel, Eng. News-Rec., LXXXVII, p. 566, 1921; Bates, P. H., Rock Products, June 26, 1926.

composition and conditions of manufacture, such as temperature of burning.

The formula for calculating the cementation index is as follows:

$$\frac{(2.8 \times \text{per cent SiO}_2) + (1.1 \times \text{per cent Al}_2\text{O}_3) + (0.7 \times \text{per cent Fe}_2\text{O}_3)}{(\text{per cent CaO}) + (1.4 \times \text{per cent MgO})}$$

The cementation indices for the several classes of cements are as follows:

Eminently hydraulic limes	0.70–1.10	
Feebly hydraulic limes	0.30–0.70	
Natural cements	1.00–2.00	$\left\{ \begin{array}{l} 1.-1.15 \text{ Natural Portlands} \\ 1.15-1.6 \text{ Most U. S. \&} \\ \text{Roman} \\ 1.66-2.0 \text{ Low lime} \end{array} \right.$
Portland cement	1.00–1.20	

It will be seen from this that the several classes may overlap somewhat.

Distribution of Lime and Cement Materials in the United States

Limestone for lime.—Limestones of suitable composition for making lime are so widely distributed that no particular regions or states require special mention. A glance at the map showing distribution of limestones (Plate LXIX) will emphasize this point.

Natural cement rocks.—Argillaceous limestones suitable for natural cement are found at a number of points. In some districts only one bed of cement rock is present, in others two or three. The rock worked in the different districts does not all come from the same geological formation, nor do the beds lie equally accessible. Thus in some districts they are flat (Milwaukee) (Plate LXXIV, Fig. 1), while in others they are strongly folded, with steep dips, and have to be worked by underground methods (Rosendale, N. Y., and Cumberland, Md.)

Among the important districts may be mentioned those of Rosendale and the Lehigh Valley region in Pennsylvania; Akron, N. Y.; Cumberland, Md.; Milwaukee, Wis.; Louisville, Ky.; and Utica, Ill.

Portland cement materials.—Clay and limestone in one form or another are so widely distributed in the United States that Portland cement manufacture would be possible at many localities. Economic conditions, however, render it in many cases impracticable, even though suitable raw materials are present.

The most important region at present lies in the Lehigh Valley district of eastern Pennsylvania, where a mixture of cement rock and high-grade limestone is used. In the central states, Ohio, Michigan, and Indiana, and even parts of New York, much Portland cement is made from a mixture of bog lime and clay. In the Virginia Coastal Plain a mixture of marl (Plate LXXIV) and clay is used. The scattered plants in other states run chiefly on limestone and clay or shale. The map (Plate LXXV) shows the distribution of cement plants.

Puzzolan cement materials. — Deposits of volcanic ash are abundant in many western states, but the material is not utilized for cement manufacture. In the construction of the Los Angeles aqueduct the experiment was successfully tried of mixing Portland cement and volcanic ash.

Production of cement materials. — Brief reference to the production of Portland and natural cement shows the relative importance of these materials in engineering and general work of construction. The Portland cement output has increased from 42,000 barrels in 1880 valued at \$126,000 to 114,789,984 barrels in 1922 valued at \$202,030,271. On the other hand the natural cement showed an output of 2,440,000 barrels in 1880, rose to a maximum of 9,868,179 barrels in 1899. In 1922 the combined shipments of natural and Puzzolan cements were down to 889,428 barrels.

And yet with the phenomenal increase of Portland cement there has been a more or less steady drop in price which brought it down from \$2.50 in 1881 to 81.3 cents in 1912 and up to \$1.76 in 1922. Natural and Puzzolan cement were valued at \$1.45 per barrel in 1922.

Gypsum Plasters

Gypsum, the hydrous sulphate of calcium, is widely used for the manufacture of plaster of Paris, cement plaster, wall plaster; in agriculture, as a retarder of Portland cement, and to a lesser extent in other industries.

Properties and occurrence. — The properties of gypsum and its varieties have been discussed in Chapter I on Minerals, while the manner of its occurrence has been described in Chapter II on Rocks. These facts need therefore not be repeated here.

Of the three main types of occurrence there described, the "rock" gypsum is the most important commercially. *Gypsite* or *gypsum earth* is of importance in Kansas, and some other states of the Great Plains region, but the gypsum sands although occurring in abundance in some parts of New Mexico are not utilized at present.

Anhydrite (see Chapter I) is found in small amounts in most gypsum

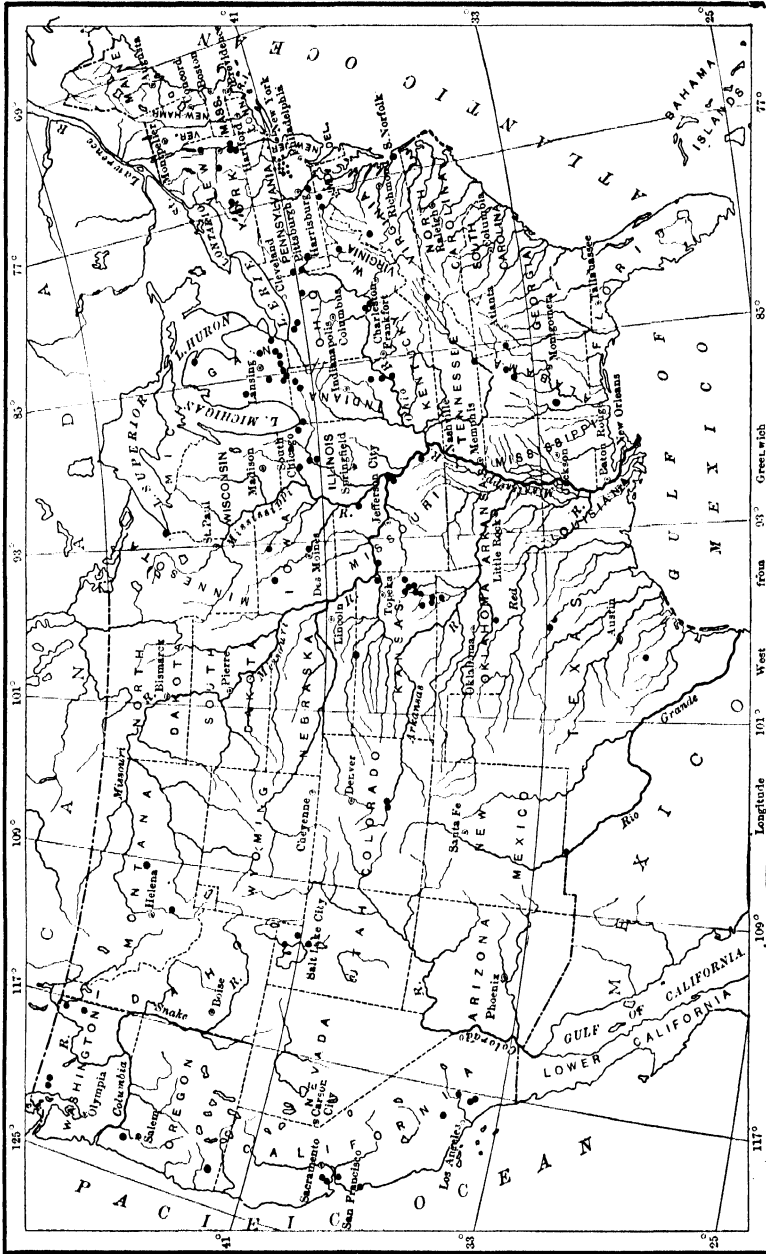

PLATE LXXV. — Map showing distribution of Portland cement plants in United States. (U. S. Geol. Survey, Min. Res., 1921.)

deposits, but in some it is abundant and forms large masses, whose shape, size and relations to the associated gypsum vary. The workmen usually recognize it readily by its slightly greater hardness.

In the gypsum deposits of Virginia, New Brunswick and Nova Scotia, for example, anhydrite is especially abundant.

If the anhydrite is more or less intimately mixed with the gypsum, and is present in large amounts the material is not marketable, but if it occurs in isolated masses or beds, it can be left in the quarry, or thrown out in working the deposit.

Anhydrite on exposure to the weather may change into gypsum, and under conditions of extreme aridity the reverse process sometimes takes place.

Chemical composition.—The following table gives the composition of gypsum deposits from a number of localities:

ANALYSES OF GYPSUM

	Pure gypsum.	Dillon, Kan.	Alabaster, Mich.	Grand Rapids, Mich.	Saltville, Va.	Gypsite, Marlow, Okla.	Gypsite, Burns, Kan.	Gypsite, Salina, Kan.	Gypsite, Dillon, Kan.
CaSO ₄	79 10	78 40	78.51	76 26	72 06	59 46	67 91	34 38	56 58
H ₂ O.....	20 90	19 96	20.96	20.84	21 30	16 59	17.72	8 50	15 16
SiO ₂		0 35	0.05	tr.	1 68	10 67	2 31	34 35	17 10
Al ₂ O ₃ and Fe ₂ O ₃		0.12	0.08	0 54	1.95	0 60	0.37	4 11	2 04
CaCO ₃		0.56	n.d.	10.21	11 71	8 14	7 71
MgCO ₃		0.57	0 11	n.d.	1.10	0 52	10 52	1 24
	100.00	99.96	99.71	97.64	96.99	98.63	100 53	100.00	99 83

	Onondaga, N. Y.	Fort Dodge, Ia.	Sandusky, O.
CaSO ₄	} 73.92 {	73.44	78 73
H ₂ O.....		20 76	19 70
SiO ₂	} 4.64 {	0.65	{ 0 91
Al ₂ O ₃			{ 0 60
Fe ₂ O ₃	} 21.44 {	
CaCO ₃
MgO.....			0.54

Chemistry of gypsum-calcination.—When pure gypsum is heated to a temperature of between 250° F. and 400° F. it loses about three-fourths of its water of combination and the calcined product is known as *plaster of Paris*, which when mixed with water, takes up in chemical combination as much as it lost, and sets to a hard mass.

Kinds of plaster.— If the gypsum contains a considerable quantity of impurities, the latter retard the setting, and such slow-setting plasters are termed *cement-plasters*. They are of value for structural work. Gypsum calcined above 400° F. is termed *dead-burnt plaster*, because it appears to have no setting properties, but if it is heated to about 900° F., and finely ground, it sets, with great slowness to a hard product known as *flooring plaster* (German *estrich-gyps*). *Stucco* is another name for plaster of Paris. *Keene's cement* is a product obtained by calcining pure gypsum at a red heat, immersing it in an alum bath, drying and calcining again.

Mack's cement is a dehydrated gypsum which is mixed with 0.4 per cent of sodium sulphate or potassium sulphate. It forms a quick, hard and durable set, and is used for flooring, or for covering wire mesh on walls or ceilings.

Neat or pure plaster may develop a strength of over 400 lbs. per sq. in. at the end of 4 weeks, while one of plaster, to one, two and three of sand, gave respectively about 350, 200 and 130 lbs. per sq. in. for the same period.

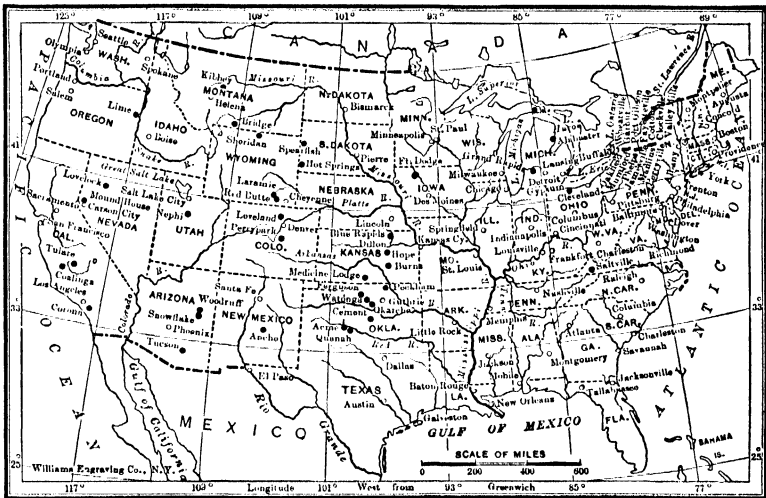

FIG. 198. — Map showing distribution of gypsum in the United States. (From Ries' Economic Geology.)

Distribution of gypsum.— Rock gypsum is quarried in a number of states, but New York, Virginia, Ohio, Michigan, Kansas, and Iowa are important producers.

The deposits are not restricted to any one geological horizon, but in the United States range from Silurian to Tertiary in age.

Gypsite is dug in some quantity in Kansas, as well as in Wyoming, Oklahoma and Texas.

The general distribution of gypsum in the United States is shown on the map (Fig. 198).

Much high-grade gypsum is exported from Nova Scotia and New Brunswick to the United States.

References on Limes and Calcareous Cements

General. — 1. Eckel, Cements, Limes and Plasters, New York, 1922 (Wiley & Sons). — 2. Humphrey, U. S. Geol. Surv., Bulls., 331 and 344 (Tests). — 3. Eno, Ohio Geol. Surv., 4th ser., Bull., 2, 1904 (Uses). — 4. Bleininger, *Ibid.*, Bull., 3, 1904 (Manufacture). 5. Bowles, Bureau Mines, Bull. 160, 1918. (Rock quarrying for cement manufacture.)

Areal. — Eckel and others, U. S. Geol. Surv., Bull., 522, 1913, contains summary of most of the literature on limestones and cement materials of the United States.

Many State Geological Surveys have issued special reports dealing with lime and cement materials, among them: Alabama, Georgia, Illinois, Indiana, Iowa, Maryland, Michigan, New Jersey, Ohio, Pennsylvania, South Dakota, Tennessee, Virginia and West Virginia.

References on Gypsum

1. Stone and others, U. S. Geol. Surv., Bull. 697, 1920 (United States). 2. Eckel, Cements, Limes and Plaster, New York, 1922 (Wiley & Sons). 3. Wilder, *Ia. Geol. Surv.*, Vol. XXVIII. (Distribution and technology. Excellent.) 4. Cole, *Can. Dept. Mines*, No. 245 *Can.*). 5. Stone, U. S. Bur. Mines, Tech. Pap. 155, 1917 (Technology). The Geological Surveys of Iowa, Kansas, Michigan, New York, Iowa, Virginia, etc., have published special papers or reports on their gypsum deposits, and some of these contain considerable matter on the technology of gypsum plasters.

CHAPTER XIV

CLAY AND CLAY PRODUCTS

As a definition of this material (clay) has been given (p. 94), there is no need of repeating it here. Its commercial value depends primarily upon the fact that it possesses two very important physical properties. These are: (1) Plasticity, by virtue of which it forms a pasty mass when wet, thus permitting it to be molded into a diversity of shapes, which it retains when dry; and (2) hardening under fire, which operates to make the given form permanent.

A number of different products are made from clay, some of which are of importance to the engineer. These include building and paving brick, sewer pipe, railroad ballast, road metal and puddle. Clay is also an essential ingredient of Portland cement, but this is taken up in Chapter XII.

Properties of Clay

These are of two kinds, physical and chemical and since they exercise an important influence on the behavior of the clay, and indirectly its uses, they will be described, remarking in advance, however, that the physical properties are the more important.

Physical Properties

These include plasticity, transverse strength, air and fire shrinkage, fusibility, and specific gravity.

Plasticity. — This, as defined above, is an exceedingly important property, and clays vary from very plastic or “fat” ones, to those of low plasticity which are termed “lean,” and are often sandy. The plasticity affects the behavior of the clay in molding. Some clays are very sticky and hard to mix, and such may also on account of their high plasticity work badly in certain types of brick-molding machines. Deficient plasticity is also bad, and may cause the clay to tear in the molding process. Manufacturers of clay products often use a mixture of two clays or of clay and sand, in order to get a mass of the proper consistency.

The amount of water required to work up a clay to its maximum plasticity varies. In lean clays it may not be more than 15 per cent,

while in very plastic ones it often rises to 30 or 35 per cent. This water must be eliminated in drying.

Transverse strength. — This represents the ability of the thoroughly dried clay to withstand a bending strain, and is measured in terms of the *modulus of rupture* (p. 462). Weak clays may show a modulus of rupture of 10 to 50 pounds, while exceptionally strong clays may run as high as 1500 pounds. The practical importance of the transverse strength is that it enables the clay to withstand the shocks and strains of handling during manufacture and before it is burned. It does not stand in any direct relation to plasticity, nor to a clay's tendency to crack in air drying.

Shrinkage is of two kinds — air shrinkage and fire shrinkage. The former takes place while the clay is drying after being molded, and is due to the evaporation of the water, and the gathering together and shrinkage of the clay particles. The latter occurs during firing, and is due to a compacting of the mass as the particles soften and fuse together under the action of heat. Both are variable.

In the manufacture of most clay products an average total shrinkage of about 8 or 9 per cent is commonly desired, and excessive shrinkage is likely to cause cracking or warping of the product. The shrinkage may be reduced by the addition of sand, or ground brick. A mixture of clays sometimes produces the desired effect.

Since clays show a variable shrinkage, the size of brick made from *different* ones will not be the same. Even in the same kiln of bricks, however, a difference in size is sometimes observable, because those which are harder-burned have shrunk more.

Fusibility. — This is one of the most important properties of clay. When subjected to a rising temperature, clays soften slowly and hence fusion takes place gradually. Indeed, it is possible to recognize three stages, which may be termed respectively, incipient fusion, vitrification, and viscosity. It is somewhat difficult at times to exactly locate each of these, so gradual is the change, but the recognition of them is of considerable practical importance. They may be defined as follows:

Incipient fusion is the point at which the clay grains have become sufficiently soft in part at least to make the mass stick together. The clay body is still very porous and can be scratched with a knife, and it is not, therefore, "steel hard."

Vitrification represents a further degree of heating, sufficient to cause enough softening of the grains, and fluxing between them to weld the whole together into a dense, practically non-absorbent mass. The clay body still holds its shape, however.

Viscosity is the stage at which the clay has become so soft due to extensive fluxing, that it no longer holds its shape.

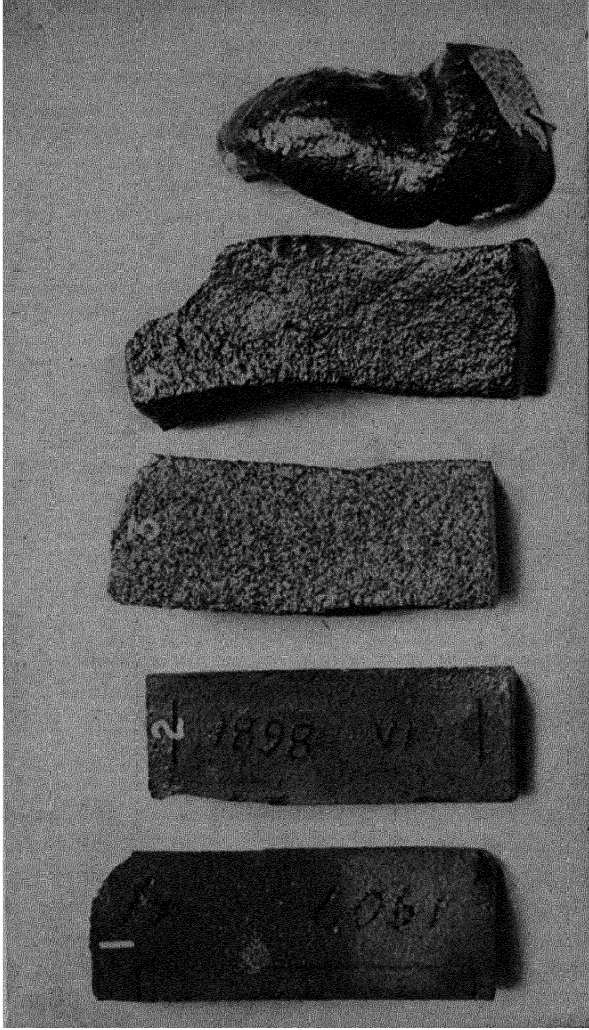

PLATE LXXVI. — Bricklets of different clays, all fired at the same temperature to show their different fusibilities. (529)

Comparison of different clays shows us: (1) That the temperature of incipient fusion is not the same in all. In the lower grades of clay that is in those having a high percentage of fluxing impurities it may begin about 1000° C., while in refractory clays it may not occur until a considerably higher temperature is attained; (2) the three stages of fusion are not equi-spaced, nor is the temperature interval between the first and third, the same in all clays. Thus in calcareous clays the temperature interval between the extreme points, is very small, possibly not more than 50° C., while in others it may be quite large.

The practical bearing of these facts is this: In burning a kiln full of ware, say one containing 100,000 brick, it is impossible to control the temperature within a few degrees, so that if the ware is to be vitrified we must have a sufficiently large temperature interval between vitrification and viscosity, to permit reaching the former point without danger of running on to the latter, and melting down the entire contents of the kiln.

The approximate extent of fusion is often indicated by the absorption. Common brick, which are usually burned to incipient fusion or a little beyond, show an absorption of 10 to 25 per cent, while paving brick which are vitrified or nearly so have a very low absorption.

If a brick, therefore, is exposed to rising temperature its fire shrinkage and density reach a maximum at vitrification, beyond which it begins to swell, and even gets more porous due to the development of a vesicular structure. The color also deepens with increasing temperature.

Color. — Raw or unburned clays are white if free from iron or carbonaceous matter. They are often colored yellow, brown, red or even green by iron oxides, and gray or black by carbonaceous matter.

Burned clays are white if free from iron oxide, but if the latter is present they will usually be buff or red depending on the quantity present and the evenness of its distribution in the clay. An excess of lime over iron counteracts the latter, and a cream or buff product results, which turns greenish or yellowish-green on vitrification. The carbon, unless burned out, may affect the color of the burned ware. It should be emphasized here that color is not a safe basis of comparison for bricks made from different clays, though many engineers seem not to be aware of this fact.

Specific gravity. — There is some difference of opinion as to the method of determining the specific gravity of a clay. Some believe that it should be determined in powdered form and this may be called the true specific gravity. Others consider that it should be determined by coating a lump of the clay with paraffine, and weighing this in air and water; but many term this the apparent specific gravity. It is sometimes urged that the latter method enables us to calculate

the weight of the clay per cubic foot, but since the water content of different clays is not always the same, the method can hardly be considered accurate. When one is dealing with soft clays, 125 pounds per cubic foot can be taken as the approximate weight, while 135 to 140 pounds should be allowed for shales.

Chemical Properties

The number of common elements which have been found in clays is great, and even some of the rarer ones have been noted; but in most clays the number of elements present is usually small, being commonly confined to those determined in the ordinary chemical analysis, which shows their existence in the clay, but not always the state of chemical combination. The common constituents of a clay are silica, alumina, ferric or ferrous oxide, lime, magnesia, alkalis, titanitic acid and combined water. Carbon dioxide is always found in calcareous clays. Carbonaceous matter and sulphur trioxide are usually present only in small amounts.

The effect of these ingredients may be briefly stated as follows:

Silica is most often present in the form of quartz grains, but it may also be contained in grains of undecomposed silicate minerals. It aids in lowering the plasticity and shrinkage and helps to increase the refractoriness at low temperatures. A clay high in silica (70 to 80 per cent) is usually sandy. *Alumina*, which is most abundant in white clays, is a refractory ingredient. Contrary to many statements which have appeared in print it stands in no direct relation to the plasticity. *Iron oxide*, as already explained, acts as a coloring agent. If the clay is burned in an oxidizing atmosphere ferric compounds are formed, but if the kiln atmosphere has a deficiency of oxygen, or if there are other substances present which have a greater affinity for oxygen, ferrous compounds result. *Lime*, *magnesia* and *alkalis* as well as *iron oxide* are fluxing impurities, which promote the fusion of the clay. In a clay of low heat resistance the combined percentage of these fluxes is high, while in a refractory or fire clay, it is small. *Titanic acid* though rarely exceeding 1 or 2 per cent, is seldom absent, and acts as a flux at high temperatures. *Vanadium* compounds are the probable cause of a greenish-yellow stain which develops on some buff bricks after they come from the kiln.

Chemically combined water and carbonaceous matter pass off at a temperature of dull redness, the former between 450° and 600° C, and the latter between 800° and 900° C. Their loss leaves the clay temporarily porous until fire shrinkage sets in.

Many a brick made from carbonaceous clay is ruined, simply because the manufacturer does not realize that the fire shrinkage should not be allowed to begin until the carbon is driven off. If allowed to remain in the brick after it is dense, the carbon robs the iron of part of its oxygen, reducing it to ferrous oxide. This unites readily with the silica in the clay forming an easily fusible ferrous silicate, which colors the center of the brick bluish-black. But as the heat rises gases are evolved by the carbon which in their effort to escape bloat the brick. Sulphur if present in the clay,

and not driven off in burning is likewise a cause of black coring and premature swelling. Such defects in a brick, therefore, may be due to carbonaceous matter and less often sulphur in the clay, and improper burning. Some brick-makers think black coring is due to setting the brick too moist, but this is only indirectly so.

The following analyses show how clays vary in their chemical composition, but it must be stated emphatically that a chemical analysis is usually valueless for judging the commercial value of a clay, as regards its use for burned clay wares.

ANALYSES SHOWING VARIATION IN COMPOSITION OF CLAYS

	I.	II.	III.	IV.	V.
Silica (SiO ₂)	46 3	45 78	57 62	59 92	68 62
Alumina (Al ₂ O ₃)	39 8	36 46	24 00	27 56	14 98
Ferric oxide (Fe ₂ O ₃)		0 28	1 9	1 03	4 16
Ferrous oxide (FeO)		1 08	1 2		
Lime (CaO)		0 50	0 7	tr.	1 48
Magnesia (MgO)		0 04	0 3	tr.	1 09
Potash (K ₂ O)		} 0 25 }	0 5	} 0 64 }	3 36
Soda (Na ₂ O)			0 2		
Titanic oxide (TiO ₂)					
Water (H ₂ O)	13 9	13 40	10 5	9 70	3 55
Moisture		2 05	2 7	1 12	2 78
Carbon dioxide (CO ₂)					
Sulphur trioxide (SO ₃)			0 35		
Organic matter					
Manganous oxide (MnO)					0 64
Total	100 00	99 84	99 97	99 97	100 66
	VI.	VII.	VIII.	IX.	X.
Silica (SiO ₂)	82.45	54.64	38 07	90 00	47 92
Alumina (Al ₂ O ₃)	10.92	14 62	9 46	4 60	14 40
Ferric oxide (Fe ₂ O ₃)	1 08	5 69	2 70	1.44	3 60
Ferrous oxide (FeO)					
Lime (CaO)	0 22	5 16	15 84	0.10	12 30
Magnesia (MgO)	0.96	2 90	8 50	0 10	1 08
Potash (K ₂ O)		5 89	2 76	tr.	1 20
Soda (Na ₂ O)				tr.	1 50
Titanic oxide (TiO ₂)	1 00			0 70	1 22
Water (H ₂ O)	2 4	3 74	3 49	3 04	4 85
Moisture		0 85			
Carbon dioxide (CO ₂)		4 80	20 46		9.50
Sulphur trioxide (SO ₃)					1 44
Organic matter					1 34
Manganous oxide (MnO)		0.76			
Total	99 03	99 05	100 28	99 98	100.35

I. Kaolinite; II. Washed kaolin, Webster, N. C.; III. Plastic fire clay, St. Louis, Mo.; IV. Flint fire clay, Salineville, O.; V. Loess clay, Guthrie Center, Ia.; VI. Pressed-brick clay, Rusk, Tex.; VII. Brick shale, Mason City, Ia.; VIII. Calcareous brick clay, Milwaukee, Wis.; IX. Sandy brick clay, Colmesneil, Tex.; X. Blue clay-shale, Ferris, Tex.

Occurrence of Clay

Classification of clay deposits.—Two important classes of clays are: (1) Residual, and (2) transported.

Residual clays.—Residual clays are derived from many different kinds of rocks by weathering processes (see Chapter IV.) The deposit thus formed will be found overlying the parent rock and often grading downward into it. From its method of origin and position it is termed a residual clay.

Residual clays are formed from feldspathic rocks by the decomposition of the silicates in them, such as feldspar, which breaks down to a clayey mass.

They are derived from shales by simple disintegration of the mass, and from limestones by a process of solution. In the latter

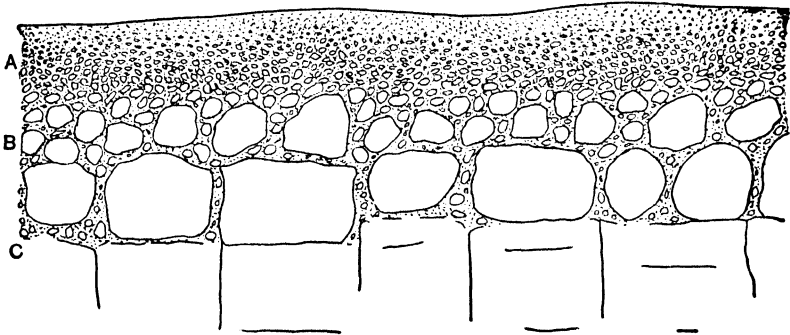

FIG. 202. — Section showing passage of the fully-formed residual clay on the surface into the solid bed rock below. A, clay; B, clay and partly-decomposed rock; C, bed-rock below, passing upward into rock fragments with a little clay. (After Ries, *Clays, Occurrence, Properties and Uses.*)

case the carbonates are dissolved out, and the residual clay represents the clayey impurities which are left behind. In this type the underlying surface of the limestone may be exceedingly uneven, chimneys of the unaltered rock extending up into the clay. This peculiarity makes it not only difficult to estimate the tonnage or volume of such a deposit without first making an excessive number of borings, but in addition these irregular rock chimneys often preclude the use of cheap methods of excavation, such as steam shoveling.

The extent of a deposit of residual clay will depend primarily on the extent of the parent rock. Its depth will depend on that to which weathering processes have penetrated the rock, and upon the degree

to which the land surface has been worn down by rain wash. It will therefore be thicker on flat or gently-sloping surfaces than on steep ones. Residual clays are moreover rare or absent in glaciated regions.

The majority of residual clays are colored by iron oxide, only those derived from iron-free rocks being as a rule white.

Transported clays. — With the erosion of the land surface the particles of a residual clay become washed away to lakes, seas or the ocean, or other places, where they settle down in the quiet water as a fine aluminous sediment, forming deposits of sedimentary clay. Such deposits are often of great thickness and vast extent.

With the accumulation sometimes of many feet of other sediments on top of them, they become consolidated by pressure and sometimes additionally by the deposit of a cement around the grains. Consolidated clay is termed *shale*, and where the consolidation is due to pressure alone it breaks down easily when ground, and forms a plastic mass when mixed with water.

Residual materials have in some instances been transported by glacial action, or even wind, to form clayey deposits.

The following are the most important types of transported clays:

Marine clays. — Clay deposits laid down on the ocean bottom. Since their deposition they have often been elevated to form dry land in all the continents, and in many cases have been consolidated, but elsewhere, as in the Atlantic and Gulf Coastal plains, they have remained unconsolidated.

Estuarine clays. — These are formed in estuaries or arms of the sea. The areas are long and narrow, as in the case of the Hudson River Valley deposits, and thin out towards the valley walls, where they rest on bed rock, glacial drift or other sediments.

Floodplain clays. — These originate by the deposition of clayey sediment during periods of flood, on the lowlands bordering a river. Such deposits are of variable thickness, sometimes very sandy, or of alternating layers of sand and sandy clay. They usually thin out towards the valley walls.

Lake clays. — Clay deposits in lakes, ponds, and swamps are included under this type. They vary from very plastic to very sandy material. The deposits are usually basin-shaped, of varying depth, and are common in many regions.

Glacial clays, often called till or boulder clay, consist of a mixture of rock flour (the result of glacial grinding) together with residual and transported clays eroded by glacial action. Glacial clays are often stony, tough, dense, and commonly unstratified. They form a mantle

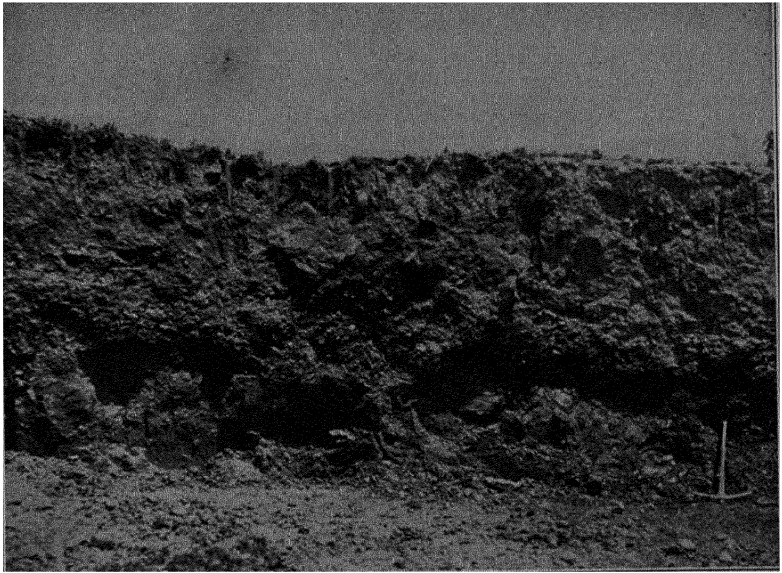

PLATE LXXVII, FIG. 1. — Deposit of stony glacial clay. (After Ries, N. J. Geol. Survey, Fin. Rept., VI., p. 128.)

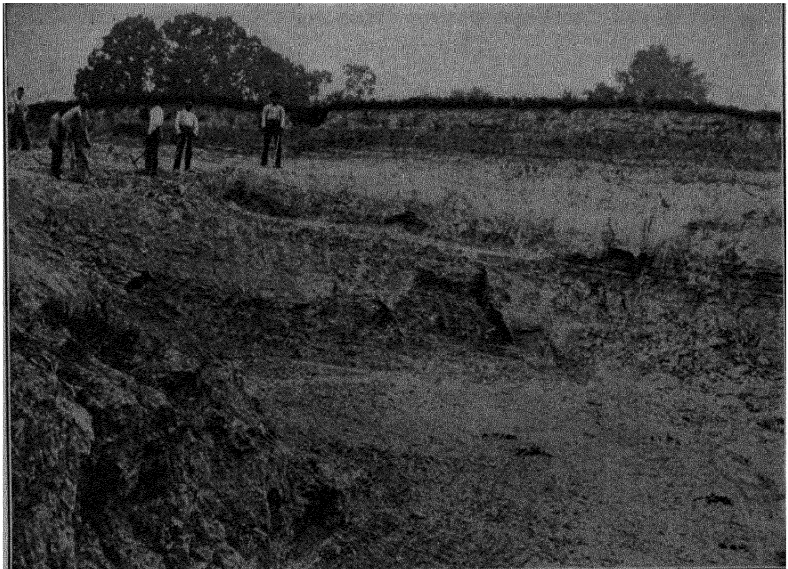

FIG. 2. — Stratified marine clay, from Athens, Tex. Shows gently dipping layers. (H. Ries, photo.)

of variable thickness, immediately underlying the surface in many regions formerly occupied by glaciers, hence they are common in the northern states. Glacial clays are used for brickmaking.

Uses of Clay

Kinds of clay. — Many kinds of clay are known by special names, which in some cases indicate their use, but in others refer to certain physical properties. Those of interest or importance to engineers are mentioned below.

Adobe. A sandy, often calcareous, clay used in the west and southwest for making sun-dried brick. *Brick clay.* Any common clay suitable for making ordinary brick. *Fire clay.* A clay capable of resisting a high degree of heat. The term is applied to many clays, having no right to it. *Gumbo.* A very sticky, highly plastic clay, of dark color, occurring abundantly in the central, west-central, and southern states. It is used for making railroad ballast and road material. *Kaolin.* A white-burning residual clay. *Loess.* A sandy, calcareous, clay, covering thousands of square miles in the Great Plains region. *Paving-brick clay.* One capable of being molded in a machine, and burning to a vitrified body at a moderate temperature. *Pressed-brick clay.* Any clay capable of being used for the manufacture of pressed brick, but usually a No. 2 fire clay. *Sewer-pipe clay.* A term applicable to any clay that can be used for the manufacture of sewer pipe.

Engineering Uses of Clay

These have been already named, and may be taken up briefly. Since the character of the product is affected not only by the nature of the raw material, but by the method of manufacture as well, these points should be given some attention in the discussion.

The use of clays for brick. — It may be stated as a general proposition that the higher grades of brick are usually made of the better grades of clay.

Clays for common brick. — The clays and shales selected are commonly of low grade, and mostly red-burning, but calcareous clays yielding a cream-colored product are worked in some regions where they abound, as in parts of Wisconsin, Michigan, Illinois, etc. The main requisites are that the clay shall mold easily, and burn hard at as low a temperature as possible. Unfortunately but little care is often used in the selection of clay for common brick, and the product shows it. Lime pebbles if present should be crushed or screened out, otherwise they are sure to cause cracking and bursting of the brick.

Clays for pressed brick. — These are made of red-burning clays or shales, cream-burning calcareous clays, or buff-burning No. 2 fire clays. The last named are most used.

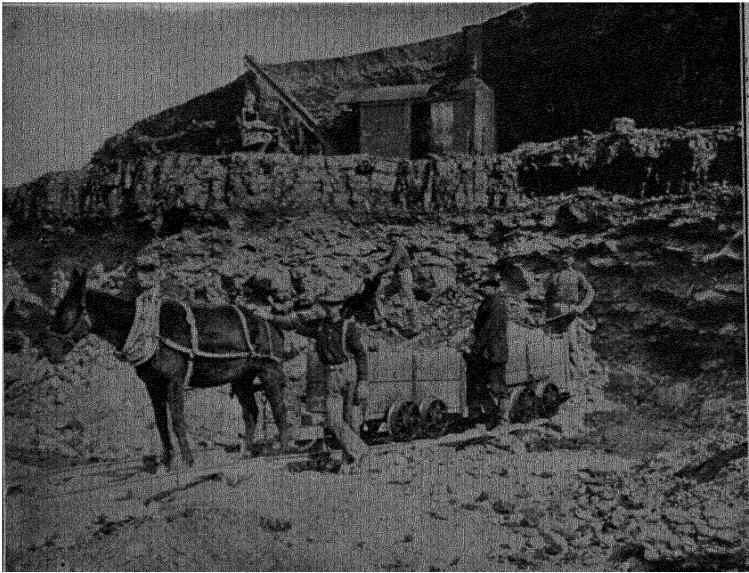

PLATE LXXVIII, FIG. 1. — Section showing fire clay underlying coal seam. The upper clay above coal is of impure character.

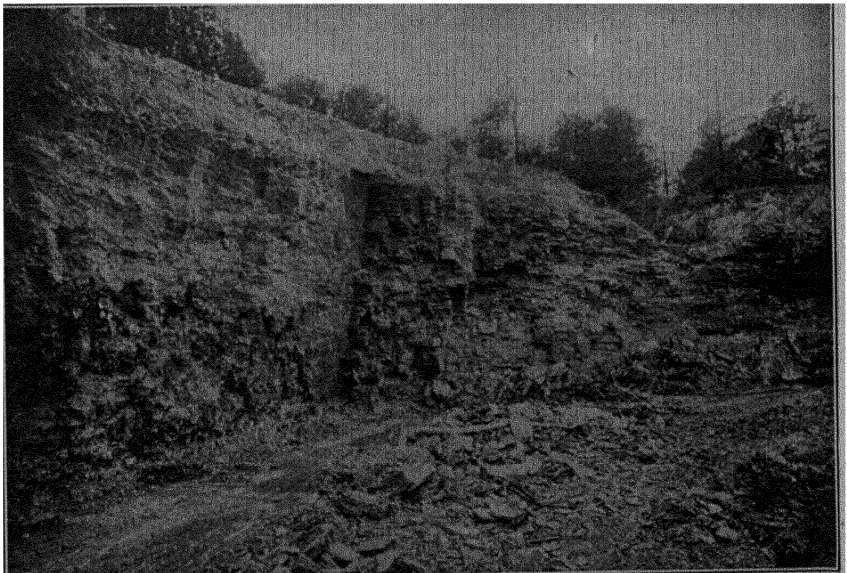

FIG. 2. — Shale used for paving blocks, Veedersburg, Ind. (After Blatchley, 29th Ann. Rept., Ind. Dept. Geol. and Nat. Res., p. 80.)

Clays for paving brick. — These are made either from red-burning clays or shales which burn easily to a vitrified body, or else from a low-grade fire clay, which gives a buff-colored ware. Both types of material are capable of yielding excellent results.

Methods of manufacture. — These may be briefly taken up in order to point out their influence on the character of the product, and some other details of importance to the engineer. The steps in the process are essentially similar for all classes of brick, the difference being chiefly in the raw material, and care used in manufacture.

The manufacture of brick can, therefore, be resolved into the following steps: Preparation, molding, drying, and burning.

Preparation. — Shales and tough clays require a preliminary disintegration to facilitate their admixture with water, or sand, or even other clays, and weathering is sometimes resorted to as a means of partial disintegration. In the mixing or tempering which follows, the water must be thoroughly incorporated into the clay, for imperfect tempering often leads to warping or splitting of the brick, because lumps of unslaked clay are left in the mass. Pebbles not previously removed by crushing or special machinery cause similar trouble.

Tempering is now done largely by machines such as the pug mill or wet pan. The former is simply a horizontal trough with blades on a revolving shaft, which cut and mix the clay. The latter is a revolving pan with two large mullers, underneath which the charge of wet clay has to pass.

Molding. — Three common methods of molding are in vogue, known respectively as the soft-mud, stiff-mud, and dry-press process. Each may be said to have its limitations.

Soft-mud process. — Soft-mud brick are made in a machine, in which the soft wet clay is forced into wooden molds. The latter usually have six compartments, and are sanded to prevent the wet clay from sticking to the wooden surface. A soft mud brick has: (1) A homogeneous structure; (2) five sanded surfaces from contact with the interior face of the mold, and a sixth rough one, caused by striking the excess of clay off the top of the mold as it comes from the machine. (3) They lack very sharp corners and straight edges. (4) Their fracture may show more pebbly particles than bricks made by the other processes.

A soft-mud machine operated by steam power will commonly turn out from 25,000 to 40,000 bricks per day. The process is adapted to a wide range of clays.

Stiff-mud process. — In this method the raw material is tempered to a stiff paste, and forced from the machine through a die of rectangular cross section, thus giving a bar of clay, which is cut into bricks by

a properly-constructed wire-cutting device. The bricks are termed either end cut or side cut, depending on whether the area of the cross section of the bar of clay corresponds to the end or side of a brick.

A stiff-mud brick can be easily recognized by the four smooth surfaces, which represent those portions of the bar in contact with the interior surface of the lubricated die, and the two cut faces showing the tearing action of the cutting wires.

Too much friction between clay and die may cause a tearing of the clay, especially on the edges of the bar, resulting in the production of serrations, like saw teeth. Stiff-mud brick sometimes show a laminated or shelly structure on a section parallel to the cut face, produced by the twisting action of the auger that forces the clay through the die. It is not observable in all brick, but apt to be especially pronounced in very plastic clays, in fact at times so much so, as to make some other molding process more desirable. Brick makers often fail to realize that each clay is a problem by itself, and that small changes in the construction of a given stiff-mud machine may turn success to failure.

The stiff-mud process while one of high capacity, 60,000 or even 100,000 bricks per day being turned out by one machine, is not adapted to all kinds of clays, those of medium plasticity giving perhaps the best results, so that defective brick are sometimes the fault of the clay and not the process.

The laminations are regarded by some as a structural weakness, and the bricks often show a tendency to spall off, when exposed to fire and water. Paving brick are commonly made by this process, and repressed as described below.

Dry-press process. — This process is generally used for front brick, and sometimes for common brick, but very rarely for pavers.

The clay, containing not more than 12 to 15 per cent moisture, is disintegrated, screened, and then pressed in steel molds in a specially-constructed, powerful press.

The advantages claimed for this process are that in one operation we get a brick with sharp edges and smooth faces. If the clay does not disintegrate readily, or is insufficiently screened, the brick show a granular structure. Dry-pressed brick if hard-burned are just as strong as others, but if not hard-burned, they frequently show a higher absorption. In other words a clay molded dry-press must usually be burned harder to get a given density and hardness, than if it were molded by another process.

Repressing. — Many soft-mud and stiff-mud brick after molding are repressed in steel molds, the main object being to smooth the surface and straighten the edges or imprint some design or markings on the surface. In some cases the brick is slightly smaller and even stronger (as shown by tests). Repressing may also give the brick a tough exterior skin, which strengthens their resistance to disintegrating influences. The following tests show some effects of repressing.

Strength.	Not repressed.	Repressed.
Crushing strength, pounds per square inch.	3107	4304
Transverse strength, modulus of rupture	440	613
Absorption.	12.0%	9.75%

Drying. — Bricks made by either the soft-mud or stiff-mud process have to be freed from most of their water before they can be burned. Where the drying is done by solar heat in the open, the yard can only produce during warm weather, but where it is done by artificial heat as in tunnels, the yard can be operated throughout the entire year. Some clays have to be dried with great care to prevent cracking, others do not.

Burning. — The temperature required for burning brick varies with the clay, the density, and degree of hardness and color desired, the same clay yielding different results when fired at different temperatures. Common bricks are usually fired at a red heat, sometimes not much above 1000° C. Pressed brick made of No. 2 fire clays are commonly burned at about 1250° C., while paving brick may be burned from as low as 1175° to 1250° C., or possibly even a little higher. Even though all the preceding stages of the process have been carried out properly, the ware may be ruined if not properly burned. The kilns used should be briefly referred to.

Common brick are often burned in scove kilns. These simply represent a rectangular pile of brick set 30 to 50 courses high, with arches left running through the bottom of the pile about every three feet. The mass is enclosed in a temporary wall which is smeared over with wet clay. Fires are built in the arches and the heat gradually works up through the kiln. Such a kiln is only adapted to common bricks; its action is not always uniform, consequently care should be taken in selecting samples from it for testing. The hardest-burned bricks are near the arches, the under-burned ones usually near the top and corners, but still local cold spots may give "pale" bricks right in the center of the kiln.

In the permanent kilns — the type used for paving and pressed brick — there are permanent walls, roofs, and fire boxes. The kiln is better controlled and we can expect a more uniform product. There may be certain differences, however, depending on the direction of the draft. In up-draft kilns, the heat enters at the bottom and passes out at the top, consequently the hardest-burned bricks may be looked for in the lower half of the kiln if the burning is not uniform, whereas in down-draft kilns, the heat enters at the top, and the reverse conditions may obtain.

Properties of bricks. — The average of a number of tests made on bricks molded by each of three methods shows that if properly burned there is not much difference in the range of crushing and transverse

strength of the several kinds. Dry-press brick often show a higher absorption.

The tests which can be applied to brick are: (1) Crushing test; (2) transverse test; (3) absorption test and porosity; (4) abrasion test; (5) frost resistance; (6) fire resistance; (7) permeability. All of these are rarely carried out, but usually only 1 and 3 for structural brick, and 1, 3, and 4 for paving brick.

Sewer pipe. — This class of ware is made from a clay or shale, or mixture of two or more kinds of these materials, whose physical properties are such that they will either burn to a vitrified body, or one of low absorption, and also take a salt glaze. In some sewer-pipe mixtures a fire clay is used as one of the ingredients.

Sewer-pipe clays are thoroughly ground if necessary, well-mixed, and then molded in a special form of press. After drying carefully in drying rooms, they are burned in down-draft kilns. The glaze is obtained by throwing salt into the fires, and the sodium vapors passing through the kiln unite with the clay to form a glaze. A poor glaze may be due to the clay, excess of soluble salts in the same, or too low temperature of burning.

The flaws which sewer-pipe may show and their causes are: (1) Blisters, due to air imprisoned in the clay during molding; (2) surface pimpling, due probably to the texture of the body and treatment during firing, but which can usually be prevented by finer grinding and slower burning; (3) warping and cracking often caused by uneven mixing, uneven heating, or inability of the pipes to stand the weight of those set on them, when red hot; and (4) fine cracks which may develop in the drying and open still further in the burning.

Sewer pipe may be tested for their strength to resist crushing, bursting, and impact under various practical conditions; their resistance to abrasion by sand or gravel; resistance to corrosion by acids, alkalis, steam, and gases; and their permeability.

Railroad ballast. — The use of burned clay for ballasting railroads is of importance in those areas where stone is wanting or if used has to be hauled a long distance. The type of clay much used in the central and western states is a very plastic sticky clay commonly known as *gumbo*, and which is often found as extensive surface deposits.

The method of use consists in locating a deposit near the line of railroad, and running a spur track out on to it. A trench 6 or 8 feet deep is dug in the clay along the track, and the clay so excavated is piled up on the opposite side. A wood fire is started in the bottom of the trench and on this are piled alternating layers of clay and fuel (either

coal or wood). The heat supplied by the burning fuel bakes the clay lumps, the larger ones becoming broken up also by the rapid heating. These hard lumps of clay can be utilized for ballast.

The cost of manufacture approximates 50 to 60 cents delivered on the cars, and the product is sometimes hauled as far as 100 miles. Burned clay is said to make a fairly satisfactory ballast, being easy on the rolling stock, and keeping well drained. If the clay is underburned it disintegrates somewhat rapidly. The making of burned clay ballast is not always practicable in thickly-settled regions, since the abundant smoke developed in the burning is regarded as a nuisance.

Road material. — In some regions where the surface clay is of gumbo-like nature, and no cheap material is available for highway construction, the burned gumbo has been used for top dressing on the wagon roads. Indeed, sometimes the upper few inches of the road bed itself are plowed up, gathered into heaps, burned, and then spread on the road again.

Puddle. — This term is applicable to any clay that can be used to form a waterproof lining or backing to a reservoir or other water-retaining embankment or wall. The two main requisites are that the clay shall be water-tight and dry without cracking. If the clay is too plastic it has to be made leaner by adding sand or gravel.

Distribution of Clays in the United States

Clays have a wider distribution than most other rocks, being found in all formations from the oldest to the youngest.

Both white and colored residual clays are derived from the older crystalline rocks, and are of widespread occurrence in the Piedmont region of the southern states. Deposits of shale as well as fire clay are abundant and important in the coal-measures formations of the eastern and central states where they form the basis of an extensive paving and fire-brick industry.

In the Coastal Plain region of the Atlantic and Gulf coast states, clays suitable for fire brick, pressed brick, stoneware, and terra cotta are obtained from the Cretaceous and Tertiary deposits. Somewhat similar uses are open to the clays of these formations found in parts of the Great Plains, in the eastern foothills of the Rocky Mountains, and along the Pacific Coast.

The surface clays of recent origin are, however, the most widespread and are used everywhere for brick and tile.

References on Clay

Technology and properties. — (1) Merrill, G. P., *Rocks, Rock Weathering and Soils*, New York, 1906 (Macmillan Co.); (2) Ries, *Clays, Occurrence, Properties and Uses*, New York, 1927 (Wiley & Sons); (3) Ries, U. S. Geol. Surv., Bull. 708, 1922 (High-grade clays U. S.); (4) Searles, *Chemical and Physical Properties of Clays and other Ceramic Materials*, London, 1924; (5) *Transactions American Ceramic Society*, Columbus, O., Vols. I to XIX and the *Journal of the American Ceramic Society*, Vols. I—date, contain many excellent papers; (6) Various bulletins of U. S. Bur. Mines.

Areal reports. — Reference No. 3 summarizes the literature dealing with the high-grade clays found in the United States. In addition, the Geological Surveys of Alabama, Connecticut, Georgia, Illinois, Indiana, Iowa, Maryland, Mississippi, Missouri, New Jersey, New York, North Carolina, North Dakota, Ohio, Oklahoma, South Carolina, Texas, Virginia, Washington, West Virginia, and Wisconsin have published special reports on the clay deposits of their respective states. Scattered papers are contained in the reports of the United States Geological Survey, and the Canadian Geological Survey has issued a series of special bulletins on Canadian clay deposits.

Supplementary references. — Ackerman, A. S. E., *Soc. of Engrs., Trans.*, 1919 (Experiments with clay in its relation to piles); *Ibid.*, 1921, p. 87 (Physical Properties of Clay).

CHAPTER XV

COAL SERIES

Kinds of Coal

Under this heading are included a number of substances consisting chiefly of a mixture of fixed carbon, volatile hydrocarbons (as well as some other volatile matter), sulphur and ash.

It is generally admitted that all the members of the coal series are of vegetable origin (p. 559), and that they probably form a lineal succession, represented by the following members, ranged from low to high rank. Peat, lignite, subbituminous, bituminous, semibituminous, semi-anthracite and anthracite. The properties of these are as follows:

Peat. — This is a surface deposit, representing the first stage in coal formation, and is formed by the growth and decay of grasses, bog moss and other plants in moist places.

A section in a peat bog from the top downward may show: (1) A layer of living plants; (2) a layer of dead plant roots, stems and leaves,

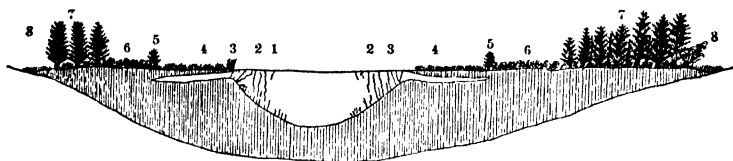

FIG. 203. — Diagram showing how plants fill depressions from the sides and top, to form a peat deposit: (1) Zone of Chara and floating aquatic plants. (2) Zone of Potamogetons. (3) Zone of water lilies. (4) Floating sedge mat. (5) Advance plants of conifers and shrubs. (6) Shrub and Sphagnum zone. (7) Zone of tamarack and spruce. (8) Marginal fosse. (After Davis, Mich. Geol Survey, Ann. Rep. for 1906.)

whose structure is clearly recognizable and which grades into (3) a layer of fully-formed peat; a dense, brownish-black mass of more or less jelly-like or cheesy character, in which the vegetable structure is often indistinct. The analyses on page 546 show the difference in composition of the different layers in a peat bog. They also indicate that in the passage from vegetable matter to peat the hydrogen and oxygen diminish, while the carbon increases in proportion.

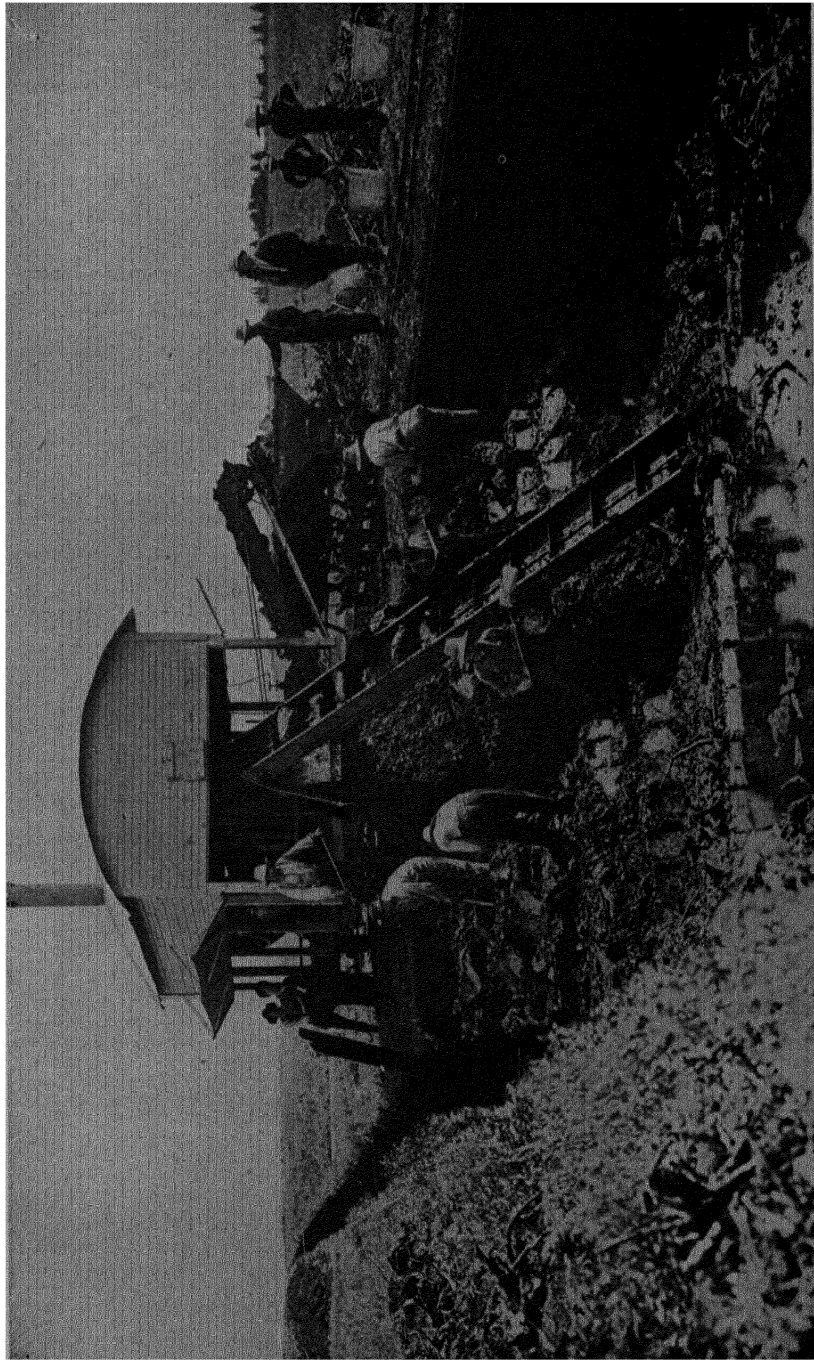

PLATE LXXIX. — View of a peat bog and peat-excavating machine. (Photo loaned by Can. Dept. Mines.) (545)

ANALYSES OF DIFFERENT LAYERS OF A PEAT BOG

Material.	Carbon.	Hydrogen.	Oxygen.	Nitrogen.
Sphagnum ¹	49.88	6.54	42.42	1.16
Porous, light-brown peat.....	50.86	5.80	42.57	0.77
Porous, red-brown peat.....	53.51	5.90	40.59	
Heavy brown peat.....	56.43	5.32	38.25	
Heavy black peat.....	59.70	5.70	33.04	1.56

¹ The fact that sphagnum occurs on the surface is not necessarily an indication that it was the only peat-forming plant present.

Peat as taken from the bog contains much moisture—often as much as 90 per cent—and has to be dried. It is then porous and light in weight, burns readily with a long, smoky flame and with a lower heating power than higher grades of coal (see Refs. 30–36).



FIG. 204. — Peaty deposit with cypress stumps covered by sandy clays due to sinking of land below sea level. Chesapeake Bay, Maryland. (H. Ries, photo.)

Lignite. — This substance, also called *brown coal*, represents the second stage in coal formation. It is often brown in color, woody in texture and has a brown streak. It burns readily with a long, smoky flame, but in its raw condition is less valuable than the higher

grades of coal, partly because of its lower heating power. Most lignite contains a relatively high amount of moisture, and the drying out of this on exposure to the air causes the material to disintegrate. On this account it should not be stored for long periods or hauled a great distance to market.

Lignite deposits are found only in the more recent geological formations (such as the Cretaceous and Tertiary) interstratified with shales and sandstones, often of only partially consolidated character.

Subbituminous coal or black lignite. — A grade intermediate between lignite and bituminous and not always distinguishable from the latter on sight. It is usually black and sometimes has a fairly bright luster. Campbell has claimed that subbituminous coal can be distinguished from bituminous on the basis of weathering, because the former checks irregularly in drying and splits parallel with the bedding on weathering, while bituminous coal shows a columnar cleavage (Plate LXXXI). The differentiation of subbituminous coal from lignite is suggested on the basis of color, the former being black, the latter brown. The term subbituminous is widely used in the United States, but it is not officially recognized in Canada, so that in the latter country some subbituminous coals are known as lignites to the dissatisfaction of the producers. Subbituminous coal occurs under similar conditions to lignite and even in formations of the same age.

Bituminous coal. — This represents the fourth stage in coal formation. It has greater density than the lignites or subbituminous coals, is deep black in color, comparatively brittle and breaks with a cubical or sometimes conchoidal fracture.

Bituminous coal burns readily, with a smoky flame of yellow color, but with greater heating power usually than the other grades already mentioned. It does not disintegrate as readily on exposure to air as lignite. Most of the bituminous coal found in the United States lies in the formations of earlier geologic age (Carboniferous) than the lignite; but where the two occur in the same formation as in parts of the Northwest and West, the lignite is in horizontal strata, while the bituminous is associated with at least slightly folded ones. This suggests that the folding bears some relation to the character of the coal.

Many bituminous coals when freed of their volatile constituents by heating to redness in an oven, cake to a hard mass called *coke*. All bituminous coals do not exhibit this property, and the discussion of it will be taken up later.

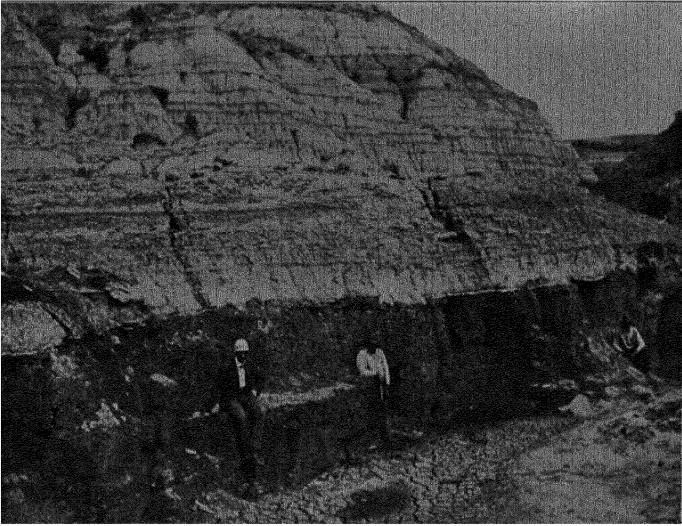

PLATE LXXX, FIG. 1. — Outcrop of lignite, Williston, N. Dak. (Photo by Wilder, from Ries' Economic Geology.)



FIG. 2. — Culm pile in Pennsylvania anthracite region.

Cannel coal. — This is a compact variety of coal, with a dull luster, conchoidal fracture, and unusually high percentage of volatile matter. It ignites easily. True cannel is a variety of bituminous coal, subcannel a variety of lignite, and canneloid a variety of anthracite (Ref. 2).

Following are two analyses of cannel coal, I from Cumberland Gap field, Kentucky, and II from Cannelburg, Indiana:

ANALYSES OF CANNEL COAL

Constituents.	I	II
Moisture.....	1.00	1.47
Volatile matter.....	51.60	49.08
Fixed carbon.....	40.40	26.35
Ash.....	7.00	23.10
Sulphur.....	0.739	1.48
Fuel ratio.....	0.78	0.53

Semibituminous coal. — This is a term which was proposed by H. D. Rogers of the Pennsylvania Geological Survey as early as 1858 to apply to those grades above bituminous, whose volatile matter was between 12 and 18 per cent, and still later in 1879 Fraser of the same organization included under it coals whose fuel ratios ranged from 8 to 5.¹

Semianthracite coal. — This was another term proposed by Rogers at the same time as the preceding one, to include coals between bituminous and anthracite having less than 10 per cent volatile matter, and it now includes coals whose fuel ratio is 3 to 10.

The retention of both terms seems perhaps unfortunate, but they persist to the present day, and are sometimes no doubt rather loosely used. Possibly the disagreement among different people as to what shall be included under these terms may partly be responsible for the confusion.

Anthracite coal. — This variety of coal is black, hard and brittle, with high luster and conchoidal fracture. It has a lower percentage of volatile matter and a higher percentage of fixed carbon than any of the other varieties. On this account it ignites less readily, burns with a short flame, but gives great heat. The fuel ratio is 10 and over.

The geological distribution is more restricted than that of bitu-

¹ The fuel ratio is the ratio of the fixed carbon to the volatile matter.

minous coal. It occurs usually in areas of somewhat strongly folded rocks (northeastern Pennsylvania), and is also found in certain areas where beds of bituminous coal have been converted into anthracite by the near approach of intrusive masses of igneous rock (Crested Butte, Colo.; Cerillos, N. Mex., etc.).

Composition of Coal

The composition of coal may be expressed in either the elementary or the proximate form. In the first there is given the percentage of carbon, hydrogen, oxygen, nitrogen, without reference to its mode of combination. In the latter an attempt is made to show the form in which the elements are combined. This is the form commonly employed as it is considered to be of greater practical value.

Below are given the proximate and ultimate composition of two coals, the ash and sulphur being common to both.

		Lignite, North Dakota.	Bituminous coal, Pennsylvania.
Proximate analysis	Moisture.....	36.13	3.51
	Volatile matter.....	29.28	16.82
	Fixed carbon.....	29.55	73.04
	{ Ash.....	5.04	6.63
	{ Sulphur.....	0.59	0.94
Ultimate analysis	Hydrogen.....	6.60	4.56
	Carbon.....	42.00	80.70
	Nitrogen.....	0.73	1.26
	Oxygen.....	45.04	5.91

Proximate analysis of coal. — The proximate analysis, though apparently a simple operation, needs to be carefully carried out to prevent variable results. The constituents of the coal are grouped as moisture, volatile matter, fixed carbon, ash and sulphur.

The moisture can be driven off at 100° C., and is usually highest in peat and lignite. The volatile matter was formerly termed the volatile hydrocarbons, but it is now clear that other substances also are driven off at a red heat, and that the volatile matter of coals differs greatly in its character.¹

Thus the coals of the younger geological formations of the West have a large proportion of carbon dioxide, carbon monoxide and water, and a correspondingly small proportion of hydrocarbons and tarry vapors.

On the other hand the bituminous coals of the Appalachian region

¹ See Bull. 1, U. S. Bureau of Mines, Washington.

yield volatile matter containing much tarry vapor and hydrocarbon compounds, which are hard to burn completely without an excess of air and high temperature.

The western coals give up their volatile matter more easily at moderate temperatures than the eastern ones. The volatile matter produced at medium temperatures is rich in higher hydrocarbons of the methane (CH₄-marsh gas) series, such as ethane and propane, which contain a larger proportion of carbon than is present in methane.

These facts help to explain the difficulty of burning Pittsburg coal, for example, without smoke, the low efficiency usually obtained in burning high-volatile western coals, the advantage of a preheated auxiliary air supply introduced over a fuel bed, and the advantage of a furnace and boiler setting adapted to the type of fuel used. They bear directly also on the question of steaming "capacity" of coals for locomotives, the designing and operation of gas producers for high-volatile fuels, and the operation of coke ovens and gas retorts.

The results of tests by the U. S. Bureau of Mines show that the inert, non-combustible material is present in volatile products of different kinds of coal in amounts ranging from 1 to 15 per cent.

The following table gives the percentage of volatile matter and coke yield in some eastern and western coals:

VOLATILE MATTER AND COKE YIELD OF COALS

Coals.	Va.	Penn.	Ill.	Wyo.	Wyo., air- dried.	Utah.	Wyo.
No. of tests, averages.....	2	6	2	4	2	2	2
Coke, per cent.....	79.1	71.4	63.1	44.7	53.0	58.6	63.9
Tar, per cent.....	7.2	11.3	11.9	7.1	5.5	12.3	10.3
Water, per cent.....	1.3	4.9	10.7	27.5	19.0	11.8	10.0
Ammonia, lbs. sulphate per ton.....	12.9	23.8	25.3	27.2	26.7	26.3	26.3
CO ₂ , per cent.....	0.44	0.72	1.2	8.14	8.41	3.13	2.13
H ₂ S, per cent.....	0.07	0.25	0.46	0.08	0.11	0.24	0.30
Gas, cu. ft. per ton (a).....	9700	8140	8400	7830	8170	7620	7940
Comp. of gas (b)							
Illuminants.....	1.4	3.2	3.0	2.2	2.6	5.7	5.5
CO.....	3.2	5.1	7.4	10.5	21.4	14.9	12.3
CH ₄ , C ₂ H ₆ , etc.....	26.4	27.8	(c) 26.3	18.1	(c) 22.6	27.2	25.4
H.....	67.8	61.0	(c) 56.8	54.0	(c) 49.3	47.8	53.1
N.....	1.2	2.9	6.5	6.2	4.1	4.4	3.7
Total volatile products (without moisture)	19.7	27.4	29.8	33.3	35.5	38.5	32.4
Water of constitution.....	0.1	3.7	3.6	5.5	7.5	8.9	6.3
Inert volatile matter (d).....	0.7	4.7	5.1	14.0	16.3	12.4	8.8

(a) Calculated to dry basis at 0° C. and 760 mm. pressure, free of air and CO₂.

(b) Calculated to CO₂ and O free basis.

(c) H calculated.

(d) Sum of ammonia, CO₂ and water of constitution.

The fixed carbon of the coal burns with difficulty and is highest in the anthracite variety.

The value of a coal for fuel purposes is determined mainly by the relative amount of its different constituents. Thus both the fixed carbon and volatile hydrocarbons represent heating elements of the

coal, the former being the stronger. The fuel ratio is the ratio of the fixed carbon to the volatile hydrocarbons. Anthracite has a higher fuel ratio than lignite. The free-burning character of a coal is due to a goodly percentage of volatile hydrocarbons.

Moisture is a non-essential constituent of coal, for it not only displaces just so much combustible matter, but requires heat for its evaporation, and when present in large amounts often causes coal to disintegrate while drying out. It ranges from perhaps 2 or 3 per cent in anthracite to 20 or 30 per cent in lignite.

The following table gives the analyses of a number of coals from different parts of the United States, and will serve to show how they vary in composition:

ANALYSES OF COALS

Locality.	Proximate				Ultimate					Calories.	B.T.U.
	Moisture.	Volatile matter.	Fixed carbon.	Ash.	Sulphur.	Hydrogen.	Carbon.	Nitrogen.	Oxygen.		
<i>Peat.</i>											
Halifax, Mass.	49 80	27 27	10 88	12 05	0 34
Orlando, Fla.	13 19	56 83	24 30	5 68	0 49	6 06	51 18	2 56	34 03	4961	...
<i>Lignite.</i>											
Lehigh, Stark Co., N. Dak.	32 64	29 19	26 75	11 42	3 54	6 15	39 53	0 49	38 87	3872	6,970
Crockett, Tex.	13 40	42 75	29 00	14 85	1 04	5 57	52 06	0 95	25 53	5199	9,358
Lester, Ark.	19 13	35 36	32 54	12 97	0 65	5 60	48 51	0 91	31 36	4714	...
<i>Subbituminous.</i>											
Tesla, Cal.	18 51	35 33	30 67	15 49	3 05	5 93	47 34	0 66	27 53	4728	...
Lafayette, Colo.	13 49	37 11	43 03	6 37	0 58	5 75	61 13	1 22	24 95	5995	10,791
Gallup, N. Mex.	8 13	34 82	37 83	19 22	1 30	5 05	56 71	0 98	16 74	5668	10,202
Glendive, Mont.	34 89	43 48	13 56	8 07	1 33	6 41	41 66	0 56	41 97	3880	6,984
<i>Bituminous.</i>											
Huntington, Ark.	1 17	17 83	68 12	12 88	1 27	4 00	75 68	1 47	4 70	7450	13,410
Coffeen, Ill.	5 13	32 68	47 46	14 73	4 45	4 88	60 51	1 23	14 20	6199	11,158
Clarksburg, W. Va.	1 46	40 14	50 50	7 90	3 50	5 09	74 44	1 37	7 70	7700	13,860
Clarion County, Pa.	2 87	34 51	54 31	8 31	1 36
Johnstown, Pa.	2 35	14 30	71 40	11 95	3 30	4 22	75 16	1 13	4 24	7382	13,288
Pocahontas steam coal, Va.	0 54	19 86	74 61	4 99	0 344
Coking coal, Wise Co., Va.	0 924	35 97	58 44	4 09	0 579
<i>Semibituminous.</i>											
Coal Hill, Ark.	1 28	12 82	73 69	12 21	2 01	3 74	77 29	1 39	3 36	7448	13,406
Paris, Ark.	2 77	14 69	73 47	9 07	2 79	4 02	78 71	1 46	3 95	7652	13,774
Gary, W. Va. (bony layer) ..	0 52	12 11	58 60	28 77	0 55	3 33	62 36	0 66	3 97	6002	...
<i>Semianthracite.</i>											
Russellville, Ark.	2 07	9 81	78 82	9 30	1 74	3 62	80 28	1 47	3 59	7612	13,703
Blacksburg, Va.	0 73	10 55	69 92	18 80	0 66	3 60	72 23	0 69	4 02	6929	...
<i>Anthracite.</i>											
Scranton, Pa. (culm).	2 08	7 27	74 32	16 33	0 77	2 81	75 21	0 80	4 08	6929	...
Mammoth seam, St. Nicholas, Schuylkill Co., Pa.	2 80	1 16	88 21	7 83	0 80	1 89	84 36	0 63	4 40	7388	13,298
Crested Butte, Colo.	3 25	3 65	87 72	5 38	0 94	3 50	84 53	1 53	4 12	7795	14,031

The ash represents non-combustible mineral matter and bears no direct relation to the kind of coal; and the same is true of sulphur, which is present as an ingredient of pyrite or gypsum. Ash also displaces combustible matter, but otherwise, in most cases, it is an inert impurity. The clinkering of coal is commonly due to a high percentage of fusible impurities in the ash.

Sulphur is an objectionable impurity in steaming coals on account of its corrosive action on the boiler tubes. It is also undesirable in coals to be used for metallurgical purposes and gas manufacture.

The term *grade* indicates the purity of the coal.

Structural Features of Coal Beds

Outcrops. — The outcrop of a coal bed is usually easily recognized on account of its color and coaly character (Plates LXXX and LXXXIV). Coal weathers easily, however, and unless the exposure is a somewhat fresh one, the material is disintegrated, the wash from it mingling with the soil, and if the outcropping bed is on a hillside, often extending some feet down the slope. This weathered outcrop is termed the *smut* or *blossom* by coal miners.

In areas where the beds have been tilted, or the slopes are steep, and where there is no covering of foreign material, the coal outcrops can often be easily traced, but in regions where the dip is flat or nearly so, and the surface level, the search for coal is often attended with difficulty, which is increased if the country is covered with glacial drift or other superficial deposits of unconsolidated character. In such cases boring or pitting is commonly resorted to.

The number of coal beds present in any given region varies, and sometimes the number is large. Thus in the Pennsylvania section as many as 20 beds are known, and in Alabama at least 55 have been counted, but all are not workable. But in any series of beds all are not necessarily sufficiently thick or of good enough quality to be workable; indeed a bed which is workable at one point may not be so at another.

Associated rocks. — Most coal beds are interbedded with shales,¹ clays or sandstones, but conglomerates and limestones are at times found not far from the coal above or below it, and sometimes may form either the floor or the roof. The sedimentary rocks associated with lignite or even subbituminous coal are not as often consolidated,

¹ These are usually but incorrectly called slates, while the coal bed is frequently called a seam or vein, although both names are incorrect.

or at least as much so, as those which are interbedded with bituminous and anthracite coal.

Coal beds are often underlain by a bed of clay, which in some regions is of refractory character; but the widespread belief that all these underclays are fire clays is wholly unwarranted.

The character of the rock overlying a coal bed is of some importance to the engineer. If firm and solid it forms a good roof, but if soft and crumbly it requires support.

If the coal measures are strongly folded the associated rocks are sometimes so badly fractured as to give considerable trouble, and in some regions of this character the beds appear to be under such strain that when the coal is mined the roof or floor rock being no longer confined bulges out into the workings. Sudden movements of this sort are called *bumps*.

Variations in extent and thickness. — Few coal beds are traceable over large areas; on the contrary they are lens-like in their nature,

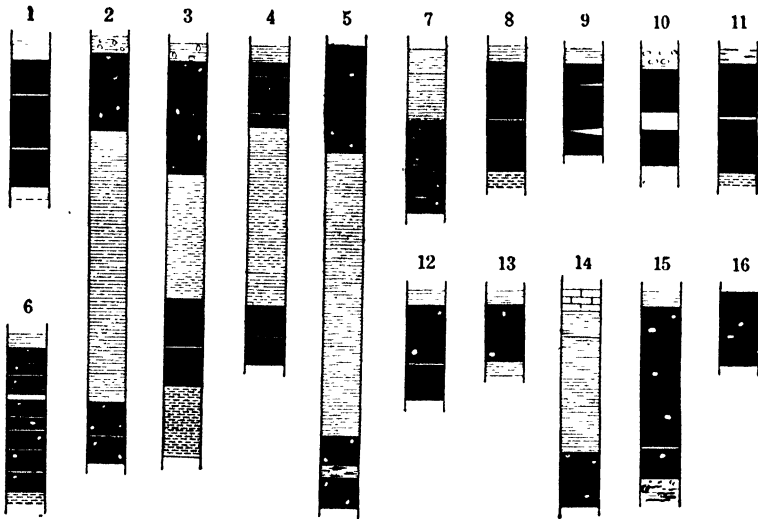

FIG. 205. — Sections of Clarion coal, Foxburg quadrangle, Pa. The coal has two beds with a variable interval of clay, shale or sandstone in between. The lower bed has a persistent "binder" one-quarter to six inches thick near the middle and in places additional binders. Nos. 1, 2, 3, 4, 5 represent both upper and lower Clarion coal, while Nos. 6 to 16 inclusive represent the lower Clarion. (After Shaw and Munn, U. S. Geol. Survey, Bull. 454, 1911.)

thinning out eventually in all directions. But a bed which thins out completely may reappear a little farther on at the same or a slightly

different stratigraphic level. Again a bed of sufficient thickness to work in one mine may be so thin in a neighboring one as to be scarcely noticeable. This thinning and thickening is commonly called pinching and swelling (Fig. 206). In regions of strong folding the coal beds are sometimes found in separate synclinal basins, the intervening anticlinal folds having been removed by erosion.

The thickness between adjoining beds also varies from place to place and the separating beds may thin out so that two coal beds coalesce. Structural features like this often render it difficult to identify the same coal beds in different sections.

The Mammoth bed, so prominent in the anthracite basins of Pennsylvania, splits into three separate beds in the Wilkesbarre basin. This splitting is caused by the appearance of beds of shale (called "slate" by coal miners), which often become so thick as to split up the coal seam into two or more beds. (See Fig. 202.) When narrow,

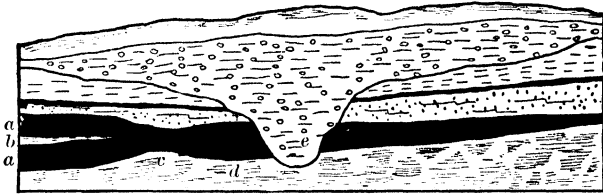

FIG. 206. — Section showing irregularities in a coal bed. *a*, split; *b*, parting of shale; *c*, pinch; *d*, swell; *e*, cut out. (From Ries' Economic Geology.)

such a bed of shale is called a parting. The Pittsburg seam of western Pennsylvania shows a fire-clay parting or "horseback" from six to ten inches thick over many square miles.

Other partings are sometimes found cutting across the beds from top to bottom. In some cases they represent erosion channels formed in the coal during or subsequent to its formation, and later filled by deposition of sand and clay. In other cases they are due to the filling of fissures formed by different causes.

Coal beds may pass into shale, the latter representing possibly islands of mud or ridges which rose above the level of the marsh in which the coal plants accumulated.

Variation in quality. — Coal beds change in quality in a variety of ways. A given bed may show uniform composition throughout its entire extent, or it may vary, being of excellent grade at one point and poor quality at another. So, too, a bed may vary vertically, the upper part perhaps being of a different nature from the lower half.

Several beds, lying one above the other, and separated by an interval of barren rock, may likewise be quite dissimilar.

Such variations in quality are commonly due to varying conditions of accumulation.

Folding.— All degrees of folding may be seen in different coal regions, from the very gentle folds of the Ohio field to the intense

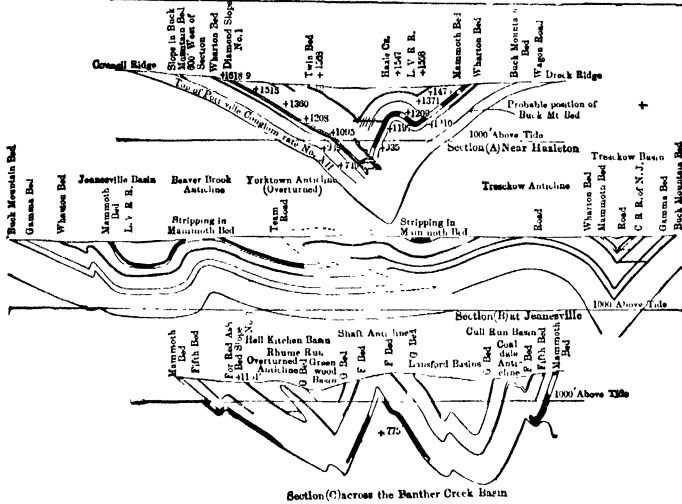

FIG. 207. — Section in coal basins of Pennsylvania, showing several beds in same section and also intense folding. (From 2d. Penn. Geol. Survey.)

crumples of the Pennsylvania anthracite region (Fig. 207). In cases like the latter, the intense folding not only breaks up the coal, but also the enclosing rocks. Since variations in the intensity of the folding cause differing dips, the amount of inclination of the beds affects to some extent the method of mining to be employed.

Faulting.— Faulting is not an uncommon feature of some coal beds, and the coal is sometimes badly crushed on either side of the fracture. The amount of slip, number, and kind of faults is variable, depending on character and force of compression or tension to which the beds have been exposed, nature of the rocks, etc. In the

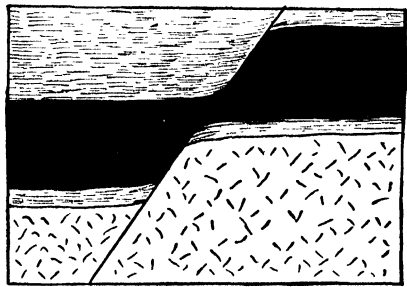

FIG. 208. — Section of faulted coal seam. (After Keyes, Ia. Geol. Survey, II.)

Appalachian region, for example, faults are rare at the northern end, as the rocks though strongly folded were more yielding, but at the southern end in Alabama where the associated formations contained more rigid beds, faults are numerous.

Classification of Coals

A number of different types of coal are recognized by the trade in both the United States and Canada, and their differentiation is based on physical and chemical characters. However, no sharp line of division exists between them, and moreover the terms are often used in a loose way.

Numerous attempts have been made to construct a satisfactory classification, but none of those suggested have met with widespread approval. (Refs. 7-12.) Some of the classifications are complex, several have to be figured on a pure coal basis, and others require an elementary analysis of the coal.

The higher ranks of coal can be fairly well separated on the basis of their fuel ratios, from 10 and above, for example, being called anthracite. Below the rank of bituminous, the subbituminous and lignite are separated on the basis of their color and manner of weathering.

Specific Gravity

The specific gravity of several ranks of coal as given by different writers is as follows:

Lignite (Moore, Ref. 13).....	.5 -1.3
Bituminous (Moore, Ref. 13).....	1.15-1.5
Bituminous, pure, Canada (Porter, Ref. 15)....	1.26-1.32
Bituminous, Ill. (Nebel, Ref. 14).....	1.28-1.33
Cannel (Moore, Ref. 13).....	1.2 -1.3
Cannel (Ashley, Ref. 2).....	1.14-1.51

Porter and Durley (Ref. 15) conclude that few, if any, coals with a specific gravity of over 1.6 are worth burning, and, except anthracites and some special types, the approximate limit is 1.55.

The gravity of coal will increase with an increase of ash. If specific gravity is used in calculating tonnage in the ground, the determination must be accurately made. Thus the apparent specific gravity of fresh coal may be 1.33, while after drying out it may be only 1.2. This difference of .13 would make a difference of 1020 tons per acre 6 feet thick, or over 650,000 tons for one square mile.

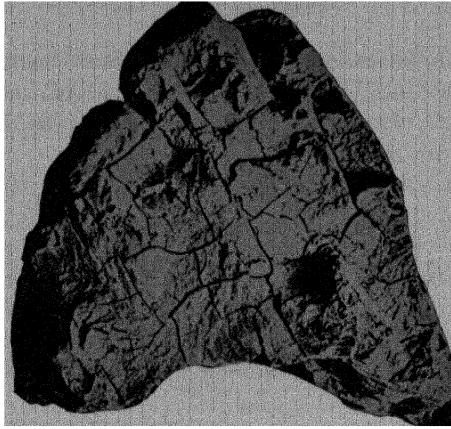

PLATE LXXXI, FIG. 1. — Subbituminous coal, showing the irregular checking developed in drying.

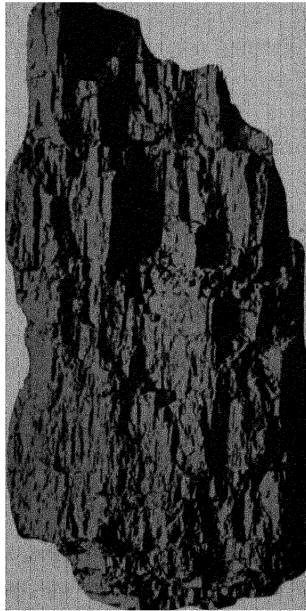

FIG. 2. — Bituminous coal, showing prismatic structure. (After Campbell, Econ. Geol., III.)

erate temperature could not have brought about considerable metamorphism in the coal.

Origin of Coal

Reference to the members of the coal series already described will show that there is an undoubted gradation between plant beds and anthracite coal (see Refs. 1-6). This theory is strengthened by the fact that coal in addition to containing the same elements as plant tissue often shows the presence of plant fibres, leaves, stems, seeds, etc. Furthermore, we sometimes find stumps or trunks of trees standing upright in the coal, with their roots penetrating the underlying bed of clay, just as trees at present stand in bogs.

The early stages in coal formation are not hard to trace, for we know that if dead vegetable matter accumulates under water, with little access of air, as in a peat bog, that it undergoes a slow process of decay, and physical change, forming the material known as peat. This differs from the living vegetable tissue chemically in having less hydrogen, oxygen and nitrogen and more carbon, and physically in being more compact, darker, and showing fewer distinct plant remains.

That pressure alone will convert the peat into a mass resembling lignite or even subbituminous coal is shown by the behavior of peat in the briquetting machine. It is therefore reasonable to assume that as a deposit of peat became buried under a considerable thickness of sediment, it would become compacted and consolidated.

It is therefore assumed that prolonged burial of a peat bed under many feet of stratified rocks gradually changes the vegetable accumulation into lignite and still further into subbituminous coal.

It has been noted in many cases, however, that the rocks are at least slightly folded in bituminous coal areas, and this leads to the suggestion that the folding not only indicates additional pressure, but that the same force generated some heat, and drove off more volatile matter.

The fact that the anthracite coal of Pennsylvania is found in a region of strong folding lends color to this view.

As further bearing on this point we may refer to some of the coals of Montana, where the lignite is found in practically flat rocks underlying the Plains, while the bituminous coals occur in the mountains where the beds are tilted due to folding.

There is some question of course how much heat was involved in the process of coal formation, and whether long pressure with mod-

A condition also stipulated by some (Campbell) is that the rocks must have been sufficiently broken by joints to permit the escape of the more volatile matter during the coal metamorphosis, otherwise marked folding of coal beds might result without changing them much.

Heat alone is no doubt a powerful factor in changing coal, for where the beds have been cut by dikes of igneous rock we find the coal on either side changed to natural coke or in some cases graphite. Or as in the Crested Butte area of Colorado, where a bed of bituminous coal has been locally changed to anthracite by the intrusion of basaltic rock into the underlying beds.

While the foregoing explanation assumes that, in general, the succession peat, lignite, etc., is a strictly lineal one, this theory cannot be said to be universally accepted. J. J. Stevenson, among others, has argued that anthracite coal has not been developed from bituminous coal by metamorphism, but that the volatile constituents were in part removed by longer exposure of the vegetable matter to oxidation before burial.

Technology of Coal

Calorific power of coals (Ref. 20). — The calorific power of coal may be expressed: (1) in calories, or the number or units (kilograms) of water, which one unit (kilogram) of fuel will raise 1° C. or, (2) in British thermal units (B. T. U.), or the number of pounds of water which one pound of fuel will raise 1° F.

The following figures are taken from the reports of the United States Geological Survey. Many others will be found there.

CALORIFIC POWER OF COALS

Kind.	Calories.	B.T.U.
Peat, high ash, York, Me.	2019	3,634
Peat.	4559	8,206
Lignite, Tesla, Cal.	4503	8,105
Brown lignite, Lehigh, N. Dak.	3421	6,158
Brown lignite, Williston, N. Dak.	3603	6,485
Subbituminous, Miles, Mont.	4432	7,977
Bituminous, Coffeen, Ill.	6031	10,856
" Carterville, Ill.	6666	11,999
" West Mineral, Kan.	7181	12,926
" Straight Creek, Ky.	7986	14,375
" Westernport, Md.	7696	13,853
" Roslyn, Wash.	8352	15,034
Semibituminous, Bonanza, Ark.	6067	10,920
Semianthracite, Blacksburg, Va.	7112	12,801
Anthracite, Scranton, Pa.	6929	12,472

Coke (Refs. 22 23) — Artificial coke is made by subjecting bituminous coals to a high temperature either with the air entirely excluded or by permitting the access of only enough air theoretically to burn the volatile matter given off from the coal. The former process is distillation, the latter partial combustion.

In distillation the coal is usually crushed to half an inch or smaller, and charged into retorts which are about 30 feet long, 6 to 8 ft. high, and 17 to 22 inches wide. The heat is supplied by the combustion gases of the coal which pass through flues in the walls of the retort oven as it is used.

The coking by partial combustion is done in beehive ovens usually 12 to 13 feet diameter, 6 to 7 feet high in the center, and 3 feet at the circumference. Each oven holds 6 to 8 tons of coal, and the coking process takes 48 to 72 hours. A modification of this is now much used.

In the retort ovens the volatile gases are saved as by-products, yielding gas, tar, ammonium sulphate, etc. The coke from either type of oven is suitable for blast furnace, foundry or smelter purposes.

The following analyses give I, the analysis of coal from Ellsworth, Pa.; II, coke from same; and III, range of composition of Pennsylvania cokes.

ANALYSES OF PENNSYLVANIA COKES

	I.	II.	III.
Moisture.....	4.73	0.23	0.23- 0.91
Volatile matter.....	34.29	1.19	0.29- 2.26
Fixed carbon.....	56.27	91.63	80.84-92.53
Ash.....	4.71	6.95	6.95-15.99
Sulphur.....	0.94	0.81	0.81- 1.87

The upper limits in III for ash, sulphur and volatile matter are extreme cases either of imperfectly-made coke or of coke made from coal that is not generally used for the purpose.

While it is recognized that many bituminous coals will coke, still the cause of coking is not clearly understood, and the chemical analysis, so far as we are able to interpret it, does not appear to throw much light on the matter. It may have some connection with the character of the plants which formed the coal.

The safest way to determine the coking qualities of a coal is by means of a practical test. It has been suggested, however, that the coking qualities of a coal can be inferred with fair accuracy by its behavior when ground in an agate mortar. Coals of good coking character stick to the mortar, while those of opposite quality are easily brushed loose. This is known as the Pischel test.

David White has also claimed that the coking value of a coal seems to be indicated with fair accuracy by the hydrogen-oxygen ratio, calculated on a moisture-free basis. Practically all coals with $\frac{H}{O} = 58$ possess coking qualities. Most coals with $\frac{H}{O}$ down to 55 make coke of some kind, a few with ratios as low as 50 will coke, though the product is rarely good. This test may fail as a guide in those coals which are undergoing anthracitization. However, while these laboratory tests may indicate whether a coal will coke, they do not give us definite evidence regarding the physical character of the product, which is a matter of considerable importance.

Natural coke or carbonite. — Natural coke is occasionally found in coal deposits, and has been formed by igneous rocks cutting across coal seams. Thus in Utah, for example, "dikes of igneous rock ten feet in width have cut vertically across a coal bed nine to sixteen feet thick, metamorphosing the coal into a coke-like substance to a distance of three feet on either side. The coke thus formed is distinctly columnar, the columns standing perpendicular to the face of the dike; it has a graphitic lustre, but is not vesicular like artificial coke." Natural coke is also found in the Cerillos field of New Mexico, the Crested Butte area of Colorado, the Richmond coal basin of Virginia, in Illinois, etc.

* In the following analyses I and II give the composition of two natural cokes and III of artificial coke.

ANALYSES OF COKE

	I.	II.	III
Moisture.....	1 116	1 66	0 29
Volatile matter.....	11.977	18 35	0 59
Fixed carbon.....	75.881	67 13	93 84
Ash.....	11 881	12.86	5 28
Sulphur.....	4.70	0 357
Phosphorus.....	0 018

It will be noticed that the quantity of volatile matter is higher in carbonite than in artificial coke. This may be due to its having been formed at some depth below the surface, thus preventing the escape of the volatile matter; or it may be due to short heating, or enrichment by gases from the neighboring coal.

At all events, carbonite is of no commercial value.



PLATE LXXXII, FIG. 1. — Beehive coke ovens, Brookwood, Ala.

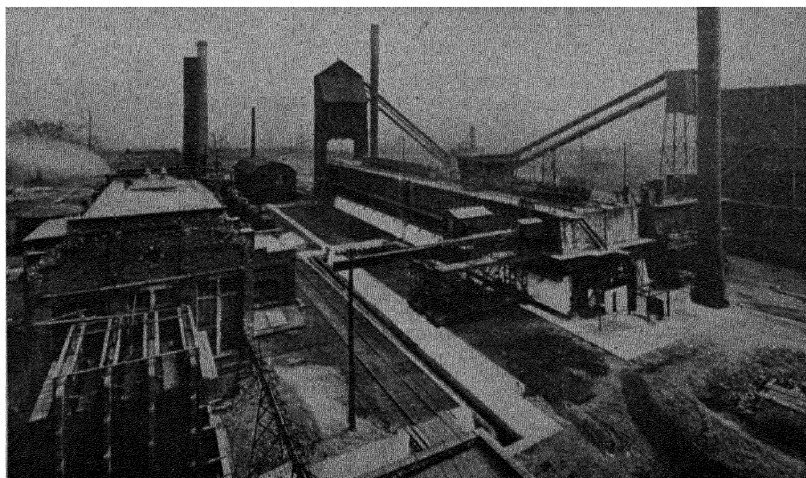

PLATE LXXXII, FIG. 2. — By-product coke ovens.

Coke-oven tar (Ref. 19). — The tar which is saved from the by-product coke ovens is of interest to engineers as the use of refined coal tar for the treatment and construction of roads is rapidly increasing in this country.¹

The growing demand for it will probably lead to a more widespread use of retort coke ovens. As one ton of coal yields on the average about 10 gallons of tar, it has been estimated from the amount of coal coked in non-recovery ovens, that the quantity of tar now allowed to escape is sufficient to build 9000 miles of tar-macadam road 15 feet wide.

Hubbard states that straight coal-tar roadbinders or refined coal tars are usually made by distilling the crude material. For construction work a soft and almost fluid pitch is often used. If it runs too high in free carbon, crude water-gas tar may be mixed with it before distillation, as this is low in free carbon. A high-carbon tar is difficult to distil properly.

Coke-oven tars are considered well adapted to roadbinders.

"In an ordinary road-tar for use in construction work where free carbon is present to the extent of about 20 per cent, the proportion of total distillate, below 315° C., to pitch residue is approximately 1 to 4. Where this relation exists the pitch residue is hard and brittle. A residue which is soft or plastic is to be preferred, as it would indicate longer life during service, and where such a residue is present the proportion of distillate would naturally be lower for a given consistency, as the distillate may be considered as fluxes for the residues."

Of 31 pitch residues from coke-oven tars, 14 were soft or plastic after distillation, a condition rare in gas-house coal tars.

The following are some analyses of coke-oven tars given on a water-free basis, but in most of these this was under 3 per cent.

ANALYSES OF COKE-OVEN TARS

Locality.	Fractions by weight.					
	Per cent free carbon	Per cent up to 110° C.	Per cent 110-170° C.	Per cent 170-270° C.	Per cent 270-315° C.	Per cent of pitch.
Syracuse, N. Y.....	7 82	0 30	0 70	11 59	7 35	79 73
Lebanon, Pa.....	4.73	1 30	0 60	15.57	8 44	74 07
Dunbar, Pa.	9 00	1 42	0.20	18 10	5.79	74 36
Everett, Mass	14.22	2 34	0 51	20 81	14 69	60.91
Gary, Ind.	2 81	1 03	0 30	19.07	6.70	72.37
Buffalo, N. Y.	17 17	0 30	1.73	10.12	10 42	76 68

Use of coals in gas producers (Ref. 18). — Some of the western states have but little good coal. The low-grade coals which occur in large quantities cannot be used in boiler furnaces, and many will not bear long transportation. In other states where good coals occur,

¹ P. Hubbard, *Dust Preventives and Road Binders*, p. 239; also U. S. Dept. Agric., *Office Public Roads*, Circ. 97, 1912.

there is also a considerable quantity of bone¹ coal, and also slack² coal, which goes to waste.

The proposition of saving these by utilizing them in gas producers has been strongly advocated by many, including the Bureau of Mines,³ and tests made by the Bureau have shown that the method is not only practicable but economically possible.

It has been estimated that on an average each coal tested in the producer-gas plant developed two and one-half times the power that it would develop in the ordinary steam-boiler plant.

Thus a low-grade North Dakota lignite when converted into producer gas developed as much power as the best West Virginia bituminous coal, burned under the steam boiler.

For simply steam-boiler work, it is questionable whether any advantage is gained by the use of producers for high-grade fuels, except the reduction or elimination of smoke, but for low-grade fuels there is a decided gain.

The composition of producer gas varies greatly, depending on the type of the producer, method and skill used in operating, regulation of air and steam supply, fuel used, etc.

The following are given in the Bureau of Mines Report as typical analyses of up-draft, pressure-producer gas.

TYPICAL ANALYSES OF UP-DRAFT PRESSURE-PRODUCER GAS
(Percentages by volume)

Constituents.	From bituminous coal.	From lignite.	From peat.
Carbon dioxide (CO ₂)	9.84	10.55	12.40
Oxygen (O ₂)	0.04	0.16	0.00
Ethylene (C ₂ H ₄)	0.18	0.17	0.40
Carbon monoxide (CO)	18.28	18.72	21.00
Hydrogen (H ₂)	12.90	13.74	18.50
Methane (CH ₄)	3.12	3.44	2.20
Nitrogen (N ₂)	55.64	53.22	45.50
	100.00	100.00	100.00

Carbon monoxide, hydrogen, ethylene and methane are regarded as desirable constituents, but the suitability of the gas for a particular industrial application depends on the relative proportion of these constituents.

Coal briquetting (Ref. 29). — The term briquet is applied to the product obtained by compressing fine coal or lignite into different shapes, either with or without the use of binding material. The forms made are known as briquets, eggettes, boulets, carbonets, coalettes, etc.

¹ Coal with shaly streaks.

² Fine or broken coal.

³ Bur. of Mines, Tech. Paper 9 and Bull. 13.

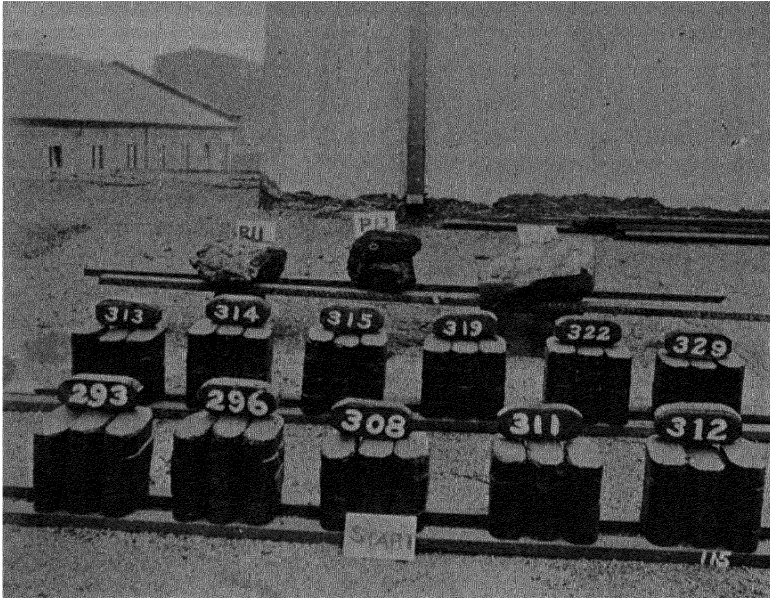

PLATE LXXXIII, Fig. 1. — Lignite briquets at beginning of weathering test.

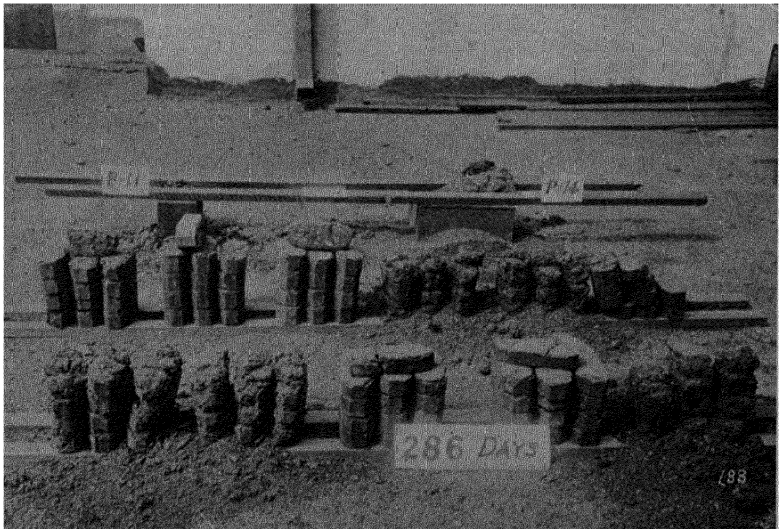

Fig. 2. — The same after 286 days' weathering. (Wright, U. S. Bur. Mines, Bull. 14, 1911.)

The successful development of the industry in the United States depends on the ability to use low-grade fuel materials, and the production of an article that will compete successfully with raw coal or coke.

The low-grade fuels that could be used are: (1) Anthracite culm; (2) slack coal from semianthracite, bituminous, and subbituminous coals of non-coking character; and (3) lignite, which disintegrates in storage or long transportation.

The briquetting industry has not developed very rapidly in the United States because of (1) a large supply of cheap fuel, (2) high labor cost, and (3) unsuccessful attempts to exploit secret processes.

The industry will probably be most valuable in those regions where there are large fields of lignite somewhat remotely located from areas of better coal.¹

Escape of gas from coal (Ref. 26). — Inflammable gas, consisting chiefly of marsh-gas (methane, CH₄), called also fire damp by coal miners, escapes from coal in many mines. Little is said to be known regarding the condition of this gas in the coal or its quantity and rate of escape. An additional quantity may also come from the rocks above and below the coal.

Coal does not give off gas alone during the period of mining, but may yield it continuously for a long time after it has been mined, this fact having been demonstrated by experiments made on certain American coals. The escape is rapid at first, but diminishes in rate and ceases after several months. The loss in fuel value due to the escape of gas is small, but the danger of accumulation of explosive gas from this source in mines and coal bunkers is sufficient to call for proper ventilation in mines and coal storages.

Coal on the whole seems to suffer but slight calorific loss when stored for some time. Storage under water preserves strength, but it is questionable whether this gain offsets the disadvantages of having to fire wet coal. It of course prevents spontaneous combustion, and so might be justified where the coal is particularly dangerous on this account.²

Distribution of Coal in the United States

The occurrences of coal and lignite in the United States can be grouped in the following regions:

	Area, sq. mi.
1. Appalachian, including parts of Pennsylvania, Ohio, Maryland, Virginia, West Virginia, Eastern Kentucky, Tennessee, Georgia, and Alabama.....	69,812

¹ See Bur. of Mines, Bull. 14; U. S. Geol. Survey, Bull. 316, 343, 366, 385, 403.

² See also Trent process for cleaning high ash coal, Chem. and Met. Eng. XXV, No.

5, 1921 and XXVI, No. 4, 1922.

³ See Tech. Paper 16, Bur. of Mines.

	Area, sq. mi.
2. Atlantic Coast Triassic, including parts of Virginia and North Carolina.....	210
3. Eastern Interior, including parts of Indiana, Illinois, and Western Kentucky.....	48,500
4. Northern Interior, including parts of Michigan.....	11,000
5. Western Interior, including parts of Iowa, Missouri, Nebraska, Kansas, Oklahoma, and Arkansas.....	71,664
6. Southwestern, including parts of Texas.....	13,500
7. Gulf Coast Lignite region, including parts of Alabama, Mississippi, Louisiana, Arkansas, and Texas.....	84,300
8. Rocky Mountain region, including parts of Colorado, Arizona, New Mexico, Utah, Wyoming, Idaho, Montana, North Dakota, and South Dakota.....	195,960
9. Pacific Coast region, including parts of Washington, Oregon, and California.....	1,830
10. Alaska.....	

The estimates of areas given above are from calculations made by the United States Geological Survey, and are to be considered as fairly accurate, although they may be extended by future development of areas now regarded as unproductive. Much coal now lies too deep to be profitably mined, but this may be sought in the future when other more easily accessible supplies become exhausted, or mining methods cheapened.

Statistics of production show that the production of the individual fields is by no means proportional to their area. Proximity to markets, value of the coal for fuel, and relative quantity of coal per square mile of productive area are factors of importance in determining the output of a field.

Each field may be surrounded by a zone whose markets are dominated by it, while between it and the neighboring field there is a belt in which the coals from both fields compete, assuming them to be of the same character.

Geologic distribution. — There is not necessarily any direct relation between the kind of coal and its geological age, especially in formations later than Carboniferous.

Coals belonging to the Carboniferous system are found east of the 100th meridian and include not only the best coals of the country, but also most of those east of the line mentioned. Triassic coals are found in Virginia and North Carolina.

Cretaceous coals lie between the 100th and 115th meridian, and Tertiary coals chiefly west of the 120th; an exception to the latter being a large area of Tertiary lignites in the Gulf States.

The character and structure of the coals may be briefly referred to.

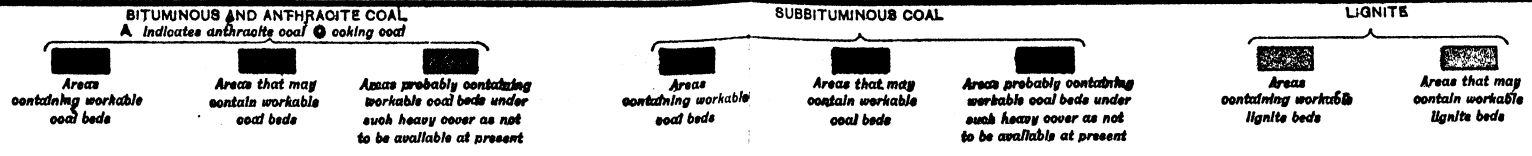
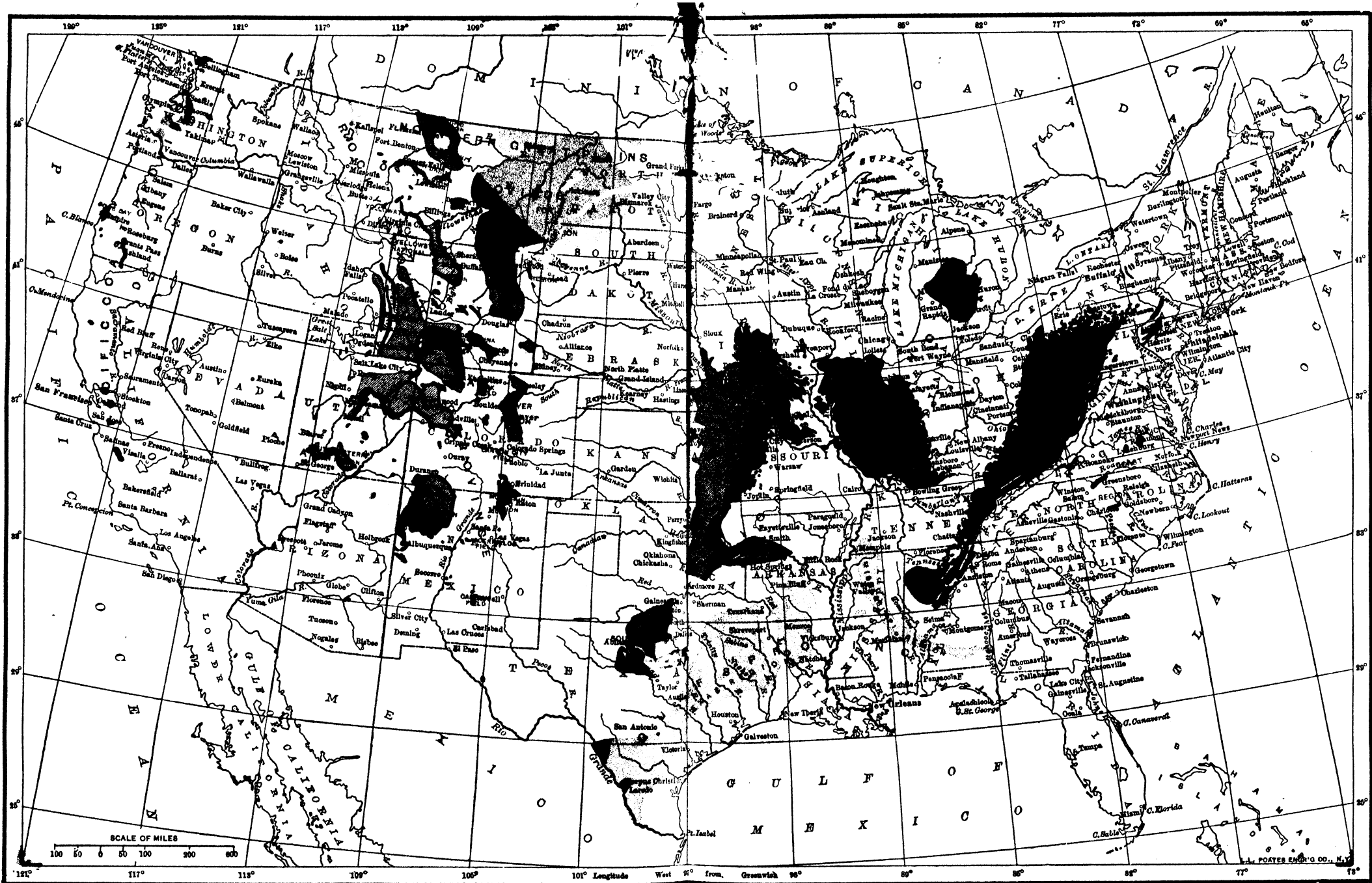

PLATE LXXXIV. — Map of coal fields of the United States. (U. S. Geol. Survey.)

Appalachian region. — This is the most important coal region in the United States, extending a distance of 850 miles from northeastern Pennsylvania to Alabama, and it is estimated that about 75 per cent of its area contains workable coal.

At the southern end the coal measures pass beneath the Coastal Plain deposits, and they may possibly connect to the westward with the Arkansas coals.

The coals of this region are closely associated with the Appalachian Mountain uplift, and hence show a similar structure. Thus on the eastern edge of the field, the coal-bearing formations are much folded, while at its southern end they are faulted in addition.

To the westward the folds become gentle. The coal beds are not continuous over the entire field, for extensive erosion has left them as a series of somewhat disconnected basins.

This variation in structural conditions, coupled with variations in topography, demands therefore a somewhat diversified method of mining.

The coal measures of the Appalachian region consist of a great thickness of overlapping lenses of conglomerate, sandstone, limestone, shale, fire clay, and coal. This means that the coal beds are not as

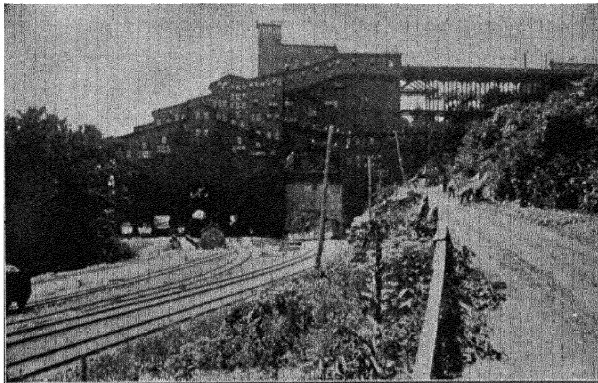

FIG. 209. — Coal breaker in Pennsylvania anthracite region. (From Ries' Economic Geology.)

a rule continuous over long distances, and while a fairly uniform succession of beds is identifiable in Pennsylvania, Ohio, Maryland, and West Virginia, the problem is less clear in the more southern states. The coals range from bituminous to anthracite.

The anthracite is confined to the highly-folded area of northeast-

central Pennsylvania, and is utilized for fuel purposes. Owing to its peculiar physical character it can be crushed to any size, and in this operation much of the shale and shaly coal, called *bone*, is separated. The fine-grained refuse from the coal breakers, known as *culm*, has, however, during the period of mining accumulated in enormous quantities, and its utilization has presented an interesting engineering problem. A great deal of it is now washed and screened to save the fine particles of clean coal; and much is also washed into the mines to support the roof, so that the pillars of coal originally left for that purpose can be removed.

The finer sizes such as buckwheat, rice, and barley, which are obtained by washing the culm, are important as steam-raising fuels, and are much used for this purpose in large buildings, especially where smoke-prohibiting ordinances exist. Their use requires special grates and furnaces, but they represent the only grade of anthracite that can compete with bituminous coal for steam raising in the eastern markets.

Outside of the Pennsylvania anthracite fields and the semianthracite fields of Virginia, the coal with very few exceptions is bituminous or semibituminous. Coking coal is found throughout the entire extent of the field; but most of the coke is made from coals along the eastern border, the coking qualities seeming to disappear toward the western margin. The Connelsville district in Fayette and Westmoreland counties of southwestern Pennsylvania is especially prominent.

Excellent steaming coals are mined in Clearfield, Allegheny, and Washington counties of Pennsylvania; in the Hocking district of Ohio; in northern West Virginia; and in the Pocahontas district of Virginia and West Virginia, the latter being known as smokeless, as well as coking.

Other well known grades are the Youghiogheny gas coals of southwestern Pennsylvania; the Cumberland smithing coal of Maryland and adjacent counties in West Virginia; the Kanawha splint and gas coals, the Massillon domestic coal of Ohio, and high-grade steaming and domestic coals of the Jellico basin.

Eastern Interior field.— This field is an oval elongated basin extending northeast and southwest, with the marginal beds dipping gently towards the lowest portion, which lies in Illinois.

The coal of this field is all bituminous, but varies in quality. That on the eastern edge of the field is called block or semi-block, because of its peculiar jointing. It is very pure, dry, and non-coking.

The rest of the coal, which is known locally as bituminous and forms more persistent beds than the block coal, is classed as coking and gas



PLATE LXXXV. — Outcrop of thick "vein" Freeport coal (bituminous) near Pittsburgh, Pa.; a-b is top of coal bed. (Photo by J. K. Johnston.)

coal, but is not sufficiently high-grade to compete, for these purposes, with the high-grade coking coals of the eastern states. For steaming purposes it competes with the Appalachian coals. Cannel coal is mined at one or two points.

Northern Interior or Michigan region. — This region forms a large basin, with the beds dipping irregularly from the margin toward the center. Owing to the heavy covering of unconsolidated deposits, such as glacial drift, outcrops are scarce, and prospecting has to be done by drilling. The coals, which are all bituminous, are used chiefly for fuel, but some are coking and others may prove of value for gas manufacture.

Western Interior region. — The coal measures, composed of limestones, shales, and coal beds, have in general a gentle western dip, and are divisible into two parts, of which the lower is on the whole the more important.

The coals are all essentially bituminous. Those of Iowa are mostly of low-grade, non-coking character, but have fairly good steaming

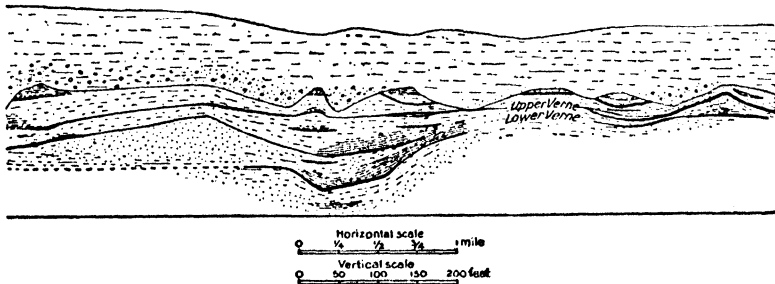

FIG. 210. — Generalized section of Michigan coal region. Shows irregularity of beds and the entire absence of outcrops due to heavy surface covering. (After Lane, U. S. Geol. Survey, 22d Ann. Rept., III.)

qualities. On account of the high sulphur content of many, they do not stock well. Much bituminous coal is mined in Kansas, and some coking coal is found. The Missouri coals are similar to the Iowa ones in quality. Arkansas produces both bituminous and semibituminous coal; indeed the latter is sometimes termed semianthracite. The quality increases from east to west, and the beds are often folded.

Rocky Mountain region. — This includes a number of separate areas extending from the Canadian boundary southward into New Mexico and Arizona. The coals range in grade from lignite to anthracite. Portions of this area are only slightly disturbed, but in others moun-

tain-building forces and igneous intrusions have affected a large proportion of the region, often materially changing the character of the coal. Thus the bituminous coal in the Crested Butte area, Colorado, or the Cerrillos field, New Mexico, has been locally changed to anthracite by igneous intrusions. Some of the coal yields a high-grade coke, such as that of Trinidad and Glenwood Springs, Colorado. Some of the lignite is also profitably used because of its nearness to market.

Pacific Coast region.—Coals ranging from lignitic to bituminous occur scattered over a wide area in the states of California, Washington, and Oregon, but the individual fields are not large. Those of Washington, which are mainly bituminous, are the most important.

References on Coal

Origin and Occurrence. — 1. Ashley, U. S. Geol. Surv., Bull. 615, 1915 (Graph. anthracite). 2. Ashley, *Ibid.*, Bull. 659, 1918 (Cannel coal). 3. Campbell, *Econ. Geol.*, I, p. 26, 1905 (Origin). 4. Campbell, *Trans. Internat. Conference Bit. Coal*, Pittsburg, 1926. (Ranks, distribution, reserves.) 5. Moore, *Coal*, New York, 1922 (Wiley & Sons). 6. White and Thiessen, U. S. Bur. Mines, Bull. 38, 1914 (Origin).

Classification. — 7. Ashley, *Amer. Inst. Min. Met. Engrs.*, LXIII, p. 782, 1920. 8. Campbell, *Econ. Geol.*, III, p. 134, 1908, and *Amer. Inst. Min. Engrs.*, *Trans.*, XXXVI, p. 324, 1906. 9. Dowling, *Can. Min. Inst., Jour.*, XI, p. 220, 1908. 10. Fieldner, U. S. Bur. Mines, *Inform. Circ.* 6094, 1929. 11. Grout, *Econ. Geol.*, II, p. 225, 1907. 12. Parr, *Ill. Geol. Surv.*, Bull. 3, 1906.

Specific Gravity. — 13. Moore, *Coal*, p. 4, New York, 1922 (Wiley & Sons). 14. Nebel, *Ill. Univ.*, Bull. XIII, No. 44, 1916. 15. Porter and Durley, *Investigations of Canadian Coals*, I, p. 165, 1912.

Technologic. — 16. Babcock, U. S. Bur. Mines, Bull. 89, 1910, and Darling, *Tech. Pap.* 178, 1918 (Utilizing lignites). 17. Darton, *Ibid.*, Bull. 72 (Gases in coal mines). 18. Fernald and Smith, *Ibid.*, Bull. 13, 1911, also Bull. 9, 1910, and Bull. 55, 1913 (Producer gas). 19. Fieldner, *Ibid.*, *Tech. Pap.*, 76, 1914 (Sampling). 20. Hubbard, U. S. Dept. Agri., *Office Pub. Roads*, Cir. 97, 1912 (Coke oven tars). 21. Parker and others, U. S. Geol. Surv., *Prof. Pap.* 48 and *Bulls.* 261 and 290 (Analyses of coals). 22. Moldenke, U. S. Bur. Mines, Bull. 3, 1910 (Coke industry). 23. Pishel, *Econ. Geol.*, III, p. 265, 1908 (Test for coking coal). 24. Porter and Ovitz, U. S. Bur. Mines, Bull. I, 1910

(Volatile matter in coal). 25. Porter and Ovitz, *Ibid.*, Tech. Pap. 16, 1912 (Deterioration coal in storage). 26. Porter and Ovitz, *Ibid.*, Tech. Pap. 2, 1911 (Escape of gas from coal). 27. Porter and others, *Can. Dept. Mines, Mines Branch, Vols. I, II, III* (Investigation Canadian coals). 28. Selvin and Fieldner, *U. S. Bur. Mines, Bull.* 209 (Fusibility coal ash). 29. Wright, *Ibid.*, Bull. 14, 1911 (Bringing tests lignite).

References on Peat. — 30. Bastin and Davis, *U. S. Geol. Surv.*, Bull. 376, 1909. (Maine.) Soper, *Ibid.*, 728, 1922. (United States.) 31. Dachnowski, *Ohio Geol. Surv.*, 4th ser., Bull. 16, 1912. (Uses and origin.) 32. Davis, *Mich. Geol. Surv.*, Ann. Rept., 1906, p. 105, 1907. (General and Mich.) 33. Haanel, *Dept. Mines, Can.*, Spec. Bull. 1912. (Peat as fuel for power.) 34. Nystrom, *Dept. Mines, Can.*, Spec. Bull. 1908. (Manufacture and uses.) 35. Parmelee and McCourt, *N. J. Geol. Surv.*, Rept. 1905, p. 223, 1906. (N. J. and analyses.) 36. Ries, *N. Y. State Museum*, 54th Ann. Rept., 1903. (New York, origin and uses.)

Areal Reports. — The Contributions to Economic Geology issued annually by the U. S. Geological Survey contain a number of short papers on different coal districts, especially western ones. Professional Paper 48 of the U. S. Geological Survey, and Bulletins 261 and 290, contain a number of analyses and tests. Bulletins 22 and 86, U. S. Bureau of Mines, contain many analyses. Many bulletins dealing with the technology and composition of coal have also been published by the Bureau of Mines.

Special reports have also been issued by the Geological Surveys of Alabama, Georgia, Illinois, Indiana, Iowa, Kansas, Kentucky, Maryland, Michigan, Missouri, Montana, North Carolina, North Dakota, Ohio, Pennsylvania, Texas, Virginia, Washington, and West Virginia. Alaska coal is treated in a number of the U. S. Geological Survey Bulletins, dealing with the mineral resources of that territory.

The Department of Mines, Canada, has issued several bulletins on peat and others dealing with tests of Canadian coal. Reports on the more important coal fields have been issued by the Canada Geological Survey.

CHAPTER XVI

PETROLEUM, NATURAL GAS, AND OTHER HYDROCARBONS

Petroleum and Natural Gas

Introductory. — Under this heading is included a series of substances, chiefly compounds of carbon and hydrogen (hydrocarbons), with variable amounts of oxygen, sulphur, and nitrogen. These substances range from gases, through liquids and viscous materials to solids, the four physical conditions being represented by natural gas, petroleum, mineral tar or maltha, and asphalt or paraffin.

All of these materials are of economic value, and some of them are of importance to the engineer.

Natural gas is widely used for heating and lighting. Petroleum is of importance as a fuel, illuminant, and lubricant, and the residue of asphaltic oils as an ingredient of paving mixtures.

Asphalt in its pure form is employed for paints, varnishes and insulation, while the larger deposits of impure nature are utilized for paving purposes.

Properties of petroleum. — Crude petroleum is a liquid of complex composition, variable color and density. It consists of a mixture of gaseous, liquid and solid hydrocarbons, the last being in solution, and the second predominating. The variation in density is due to varying amounts of the three kinds of hydrocarbons mentioned above.

American petroleum may have a paraffin base (most Pennsylvania oils), an asphaltic base (Texas and many California oils), or a mixed asphaltic and paraffin base (some Illinois and mid-continental petroleum).

The paraffin oils predominate east of the Mississippi, while the asphaltic oils are abundant west of it. Most petroleum contains some nitrogen, but the quantity present rarely exceeds 2 per cent.

Sulphur, though usually present, is abundant only in exceptional cases, and then the oil requires special treatment to eliminate it.

Petroleum commonly vary in specific gravity between about 0.8 and 0.98, but the gravity is usually expressed in terms of the Beaumé scale, on which 10° is equivalent to a specific gravity of 1 as compared with water. Thus a heavy oil would be 12° or 14° Beaumé, while a light one would be about 46° Beaumé.

Petroleum also varies: (1) In the temperature at which it solidifies; (2) in the minimum temperature at which it gives off inflammable vapors (flashing point); and (3) in the boiling point.

When petroleum is subjected to a rising temperature, the lighter oils pass off first, and then the heavier ones, the more important oils which can be separated being gasoline, benzine, and heavy kerosene, while there is left behind a residue of paraffin or asphalt-like character.

The oils, found in different fields, or even in the several strata of the same field, may consequently yield different percentages of the same kind of distillate.

Illuminating oil is of low gravity, lubricating oil of medium, and fuel oil of high gravity (comparatively speaking). Fuel oils are commonly used in their crude form.

Properties of natural gas. — Natural gas consists chiefly of marsh gas—fire damp— CH_4 . It is colorless, odorless, burns often with a luminous flame, and when mixed with air is highly explosive.

Other hydrocarbons, such as ethane (C_2H_6), ethylene (C_2H_4), carbon monoxide, and carbon dioxide may be present. The nitrogen content is variable, and rarely large. Some contain helium in extractable quantities.

The following analyses of natural gas will serve to show how it may vary in composition:

ANALYSES OF NATURAL GAS¹

Constituents.	1	2	3	4	5
Methane (CH_4)	94.40	82.25	14.85	73.81	
Ethane (C_2H_6)	0.00	0.00	0.41		98.90
Olefine (C_2H_4)	0.00	0.12			
Carbon dioxide (CO_2)	0.00	0.61	0.00	0.81	0.40
Carbon monoxide (CO)	0.00	0.00	0.00		
Oxygen	0.23	tr.	0.20	3.46	
Nitrogen	5.08	16.40	82.70	21.92	0.70
Hydrogen	0.00	0.00	tr.		
Helium	0.183	0.616	1.84	undetermined	
Hydrogen sulphide (H_2S)					

1. Iola, Kas.

2. Fredonia, Kas.

3. Dexter, Kas.

4. Pittsfield, Ill.

5. Pittsburgh, Pa.

The one analysis from Dexter, Kas., is exceptional, because of its high nitrogen content, which renders it non-inflammable.

¹ Many additional analyses can be found in the U. S. Geol. Survey, Min. Res., 1911, II, p. 324, 1912, and special bulletins of U. S. Bur. Mines.

Natural gas is used chiefly for heating and illumination, but the wasteful use of this product in some states has nearly exhausted the supply in those regions.

The table given below brings out the essential differences between natural gas and other fuel or illuminating gases.

ANALYSES OF NATURAL AND MANUFACTURED GASES

Constituents.	Average Pa. and W. Va.	Average Ohio and Indiana.	Average Kansas.	Average Coal Gas.	Average Water Gas.	Average Producer Gas Bit. Coal.
Marsh gas, CH ₄	80 85	93 60	93 65	40 00	2 00	2 05
Other hydrocarbons	14 00	0 30	0 25	4 00	0 00	0 04
N	4 60	3 60	4 80	2 05	2 00	56 26
CO ₂	0 05	0 20	0 30	0 45	4 00	2 60
CO	0 40	0 50	1 00	6 00	45 00	27 00
H	0 10	1 50	0 00	46 00	45 00	12 00
H ₂ S	0 00	0 15	0 00	0 00	0 00	0 00
O	tr.	0 15	0 00	1 50	1 50	0 05
Lbs. in 1000 cu. ft.	47 50	48 50	49 00	33 00	45 60	75 00
Sp. gr.	0 624	0 637	0 645	0 453	0 600	0 985
B.T.U. per 1000 cu. ft.	1,145,000	1,095,000	1,100,000	755,000	350,000	155,000

Dry natural gas is that which consists chiefly of methane, and is used in increasing quantities for the manufacture of carbon black. Wet or casing-head gas contains, besides methane, varying amounts of the heavier hydrocarbons, and is yielded with the oil in many wells, as well as by gas wells located in oil pools. It is much used in making gas-gasoline.¹

In recent years considerable attention has been given to the waste of natural gas, and methods for preventing it, for the early exhaustion of some large fields has been due to the reckless manner in which it has been used.

The following are the chief causes of waste according to Day:² (1) Free escape of gas from natural gas wells that have not been closed in. (2) Free escape of gas from oil wells. (3) Abuse of gas by the use of its pressure to drive steam engines in oil fields. (4) Abuse by jetting the gas into oil wells, for the purpose of a gas lift instead of an air lift in oil production. (5) Wasteful installation of gas burners and lights in oil-well drilling. (6) Waste by selling at flat rate. (7) Waste from open grates, inefficient furnaces, improperly-adjusted mixers, and other causes, by consumers. (8) Overheated buildings.

Occurrence of oil and gas. — Oil and gas are with few exceptions always found in sedimentary rocks. At least a little gas usually oc-

¹ Bur. Mines, Tech. Paper 10.

² U. S. Geol. Survey, Min. Res., 1911, II, p. 280, 1912.

curs with the oil, but the gas is at times alone. A well may yield either one or the other.

The two are sometimes found in separate beds, or in different parts of the same bed. In most cases the oil or gas has collected in the pores of the rock, but occasionally they are found in joint planes or other kinds of cavities.

The rock containing the oil or gas is known as the oil or gas rock, or *sand*. It is usually a sandstone of varying coarseness and porosity, and less often a limestone or even shale. Even an apparently dense rock can hold a surprisingly large amount of oil or gas. White estimated that fairly productive sands may hold from six to twelve pints of oil per cubic foot, but that probably not more than three-fourths of the quantity stored in the rock is obtainable.

That portion of a formation containing the oil or gas is known as a *pool*. A district may contain several pools, and in each one there may be one or more sands lying at different levels (Fig. 209). Indeed, in some districts as many as 10 or 12 sands may be struck in drilling, but all are not necessarily productive in all parts of the area.

The thickness of the producing rock ("pay sand") will vary in the different fields. In some, the sand is as thin as 2 feet, in others

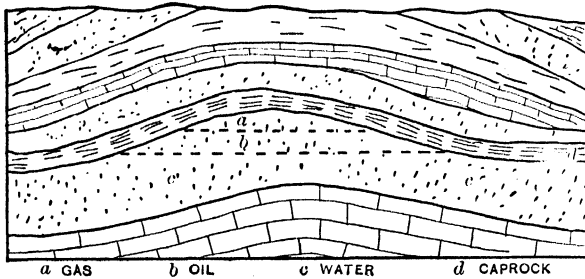

Fig. 211. — Section showing association of oil and gas with anticline. (After Hayes.)

as much as 75 or 100 feet. Its depth below the surface may range from 50 or 60 to 4000 feet or more.

Well pressure. — Both oil and gas are usually under pressure, so that if any line of escape is opened up they rise towards the surface, sometimes with sufficient force to eject the string of drilling tools.

¹ For other estimates see Washburne, Amer. Inst. Min. Engrs., Trans., 1915, and Bell, Amer. Soc. Mech. Engrs., Trans., XXX.

will collect farther down the dip and perhaps even in the synclines where the rocks are dry and porous. The water accompanying oil and gas is of saline character.

Indications of oil and gas. — Surface indications of oil and gas are sometimes found. For the first they may consist of oil seepages, bituminous sands, asphalt veins and bituminous pools. For the second they are surface flows of gas. Both types may be misleading and should be accepted with caution.

Origin of Oil, Gas and Asphalt

There is evidently a close genetic relationship between the different hydrocarbons, as is seen from the fact that: (1) The gases given off by petroleum are similar to those predominating in natural gas; (2) the exposure of many petroleums to the air results in a change to a viscous mass and finally to a solid asphalt or paraffin-like substance; (3) oil and gas often occur together in the same rock; and (4) asphalt deposits are sometimes found in petroliferous formations.

It is now commonly believed that petroleum has been derived mostly from plants of low orders, which on decaying yield waxy, fatty gelatinous or resinous products, and mingled with which there may be more or less animal matter. This plant and animal matter was deposited as organic detritus in mud or slimes, on the bottom of various bodies of salt or fresh water. After undergoing destruction by aerobic bacteria, it was later and for a long time subjected to deoxidation by anaerobic microbes, whose work caused the generation of methane (CH_4). These products of decay became subsequently buried under other sediments, where they underwent further changes resulting in the formation of hydrocarbon compounds.

Oil and gas may therefore be derived from vegetable matter the same as coal, and it has been suggested by White¹ that whether the organic matter is transformed into some kind of coal or oil or gas will depend probably on the composition of the débris, condition of accumulation, or extent of microbial action, which takes place before the close of this first or biochemical stage. In the dynamo-chemical stage which follows burial under other sediments, other changes have gone on, and the progressively more altered shales, when distilled, yield the oils with the greatest amount of light hydrocarbons.

Oil, gas and coal may occur in the same regions, and White has shown that where the rocks were sufficiently affected regionally by metamor-

¹ Geol. Soc. Amer., Bull., XXVIII, p. 728, 1917

phosing agents to devolatilize the coals to 65 per cent of fixed carbon or greater, any oil the rocks may have previously contained has been devolatilized and driven off.¹ Consequently, oil is not commonly found in commercial quantities where the coal contains above 60 per cent fixed carbon figured on a moisture-free basis. White's law of the parallelism of oil distribution to regional metamorphism has been found to be true in many parts of the United States (Refs. 1, 12).

There are several less widely-accepted theories all based on the hypothesis that the hydrocarbons are of inorganic origin (Refs. 1, 2, 11).

Since the solid bitumens are often found in veins, it is supposed that the oil has seeped into these, and subsequently hardened by the loss of its more volatile constituents.

Cases are known where oil has oozed from fissures, spread over the surface, and gradually changed to asphalt or paraffin.

Distribution of Petroleum in the United States

The important oil fields of the United States are the Appalachian, Ohio-Indiana, Illinois, Mid-Continental, Gulf coast, California, Colorado, and Wyoming. Outside of these, small areas have been developed or prospected in Michigan, Utah, Missouri, Arizona, New Mexico, Alaska, etc.

It is almost impossible to have a map showing accurate distribution without revising it from year to year.

Appalachian field. — This field covers the largest area of those in the United States, but is no longer the most important, as it supplies but little over 4-5 per cent of the country's production.

The oil-bearing rocks, which range from Ordovician to Carboniferous in age, are chiefly sandstones, with a few limestones, embedded in and underlain by a great thickness of shales, while below these are probably limestone beds. The oil-bearing rocks occupy the bottom and west side of a great structural trough, within which are a number of subordinate folds. The sands range in depth from 100 to 4000 feet. In recent years much drilling has been done in Kentucky and Tennessee, and more recently in Ohio, resulting in finding oil at lower horizons than in other parts of the field, but the output from these has not been sufficient to overcome the general decline.

The oil obtained from the Appalachian field has been of high grade, practically free from sulphur, and usually from asphalt, but rich in

¹ White, Jour. Wash. Acad. Sci., V, No. 6, p. 189, 1915.

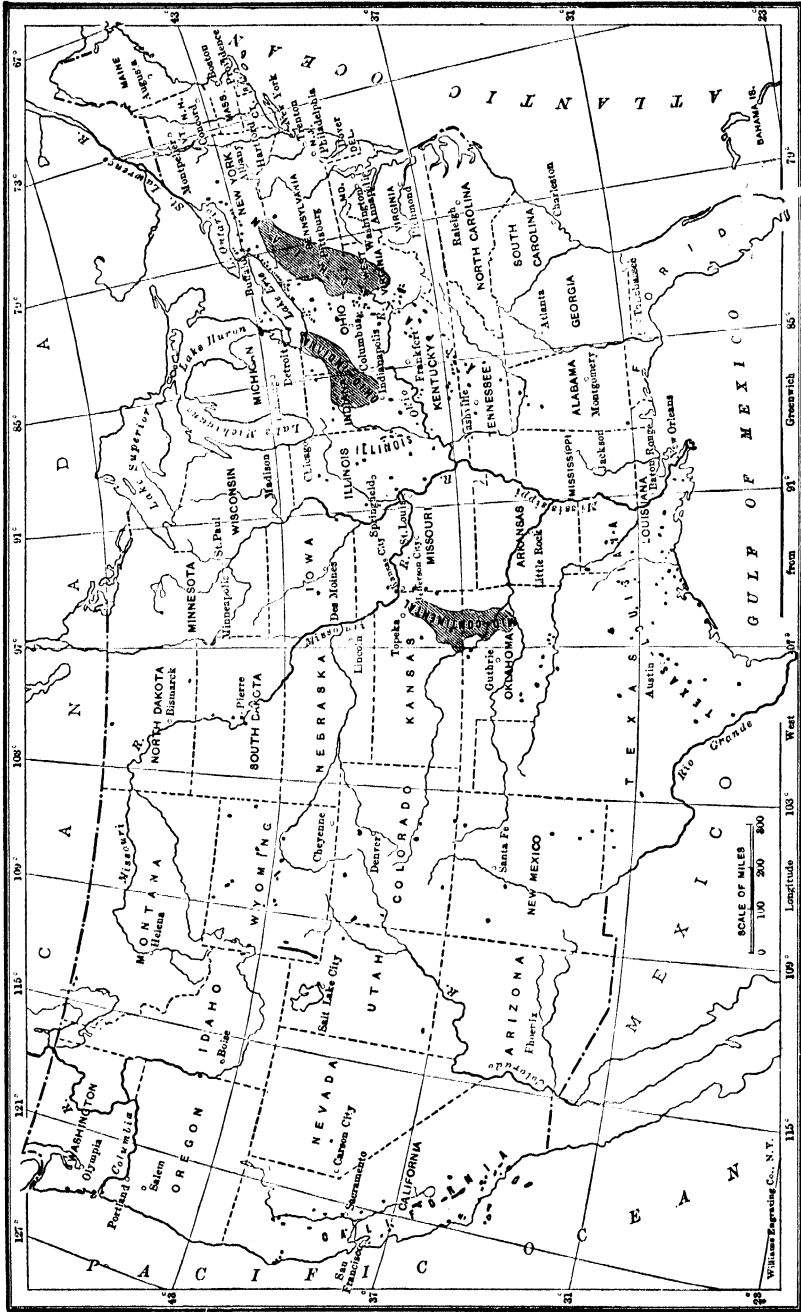

PLATE LXXXVI. — Map showing oil and gas fields of the United States. (After Day from Ries' Economic Geology.)

paraffin wax. The Kentucky and Tennessee oils are inferior to those of Pennsylvania, and much is obtained from shallow depths.

Ohio-Indiana field. — The oil in this field is found in Trenton limestone. It is high in sulphur and requires special treatment. Though formerly a large producer, the output has dropped off considerably, even though in 1911 oil was found in the Trenton limestone at a depth of about 1000 feet below the previous pools.

Illinois field. — This field showed an increasing production to 1910, and has since steadily declined. The main portion of the field is associated with a structural feature known as the La Salle anticline, extending from the southeastern part of the state into southwestern Indiana. The oil is thick, asphaltic and contains sulphur in the northern portion, but in the southern part of the field it is found at a greater depth (2200+ ft.), is thinner, and contains little or no sulphur. The oil sands are of Carboniferous age.

Mid-Continental field. — This field underlies a portion of southeastern Kansas and northeastern Oklahoma, and extends roughly from Paola, Kansas, to Muskogee, Oklahoma. The north Texas and north Louisiana (Caddo field) might also be included, as the products are similar, although they are not found at the same geologic horizon. The oil of Kansas and Oklahoma is in general found in Carboniferous sandstones. Those of north Texas and Louisiana in Cretaceous. Most of the Kansas oils are asphaltic, but in Oklahoma oils of both paraffin and asphaltic types are found. In northern Louisiana and Texas, paraffin oils free from sulphur predominate, but heavier oils are known. The field ranks second in importance.

Gulf field. — Within this field are included a number of scattered areas lying in the Coastal Plain region. The oils have been found in association with certain salt domes, which also carry limestone and gypsum. The oils are mostly heavy, asphaltic and sulphurous, but exceptionally lighter, non-asphaltic ones occur.

California field. — This state is now the leading producer, the output coming from a number of fields, which differ so that it is difficult to generalize regarding them. The California oils have been usually characterized by much asphalt, although in recent years not a few lighter ones have been found. They are often in rocks that have been much disturbed and some are obtained over 5000 feet below the surface, as in the recent wells drilled near Los Angeles.

The following table gives a summary of the occurrence of oil in the principal fields:

SUMMARIZED TABLE OF OIL OCCURRENCES IN THE UNITED STATES

Field.	Structure.	Geologic Age.	Kind of Rock.	Kind of Oil.
Appalachian.	Geosyncline with subordinate anticlines.	Ordovician to Carboniferous.	Mostly sandstone.	Paraffin base.
Lima-Indiana.	Anticlines.	Ordovician.	Mostly limestone.	Paraffin base. Sulphur.
Illinois.	Low anticlines (?)	Carboniferous.	Sandstones.	Paraffin and mixed oils.
Michigan.	Probably anticlines.	Silurian.	Sandstones.	Paraffin base.
Mid-Continental.	Westerly dip with some anticlines.	Carboniferous. Cretaceous.	Shales, sandstones, mostly.	Both paraffinic and asphaltic.
Wyoming.	Usually folded.	Carboniferous to Tertiary.	Mostly sandstone.	Paraffinic and asphaltic.
Colorado.	Folded.	Cretaceous.	Sandstone and shale.	Paraffinic.
Gulf Coast.	Domes.	Tertiary and Cretaceous.	Dolomite and sandstone.	Mainly asphaltic, sometimes high sulphur.
California.	Folded and faulted.	Tertiary.	Sandstones, shales, conglomerates.	Mainly asphaltic.
Alaska.	Folded and faulted.	Jurassic to Tertiary.	Sandstones and shales.	Paraffin.

Distribution of Natural Gas in the United States

The distribution of natural gas is practically co-extensive with petroleum. Most oil wells yield some gas, but the gas regions are fewer in number than the oil regions. In the Appalachian field gas has been found from New York to Alabama, but West Virginia is at present the chief producer. Much is obtained in Pennsylvania and Oklahoma. The Trenton limestone gas of the Ohio-Indiana field is practically exhausted, but gas is now being obtained from the Clinton sand of Ohio. While the gas field of southeastern Kansas is practically exhausted, its place is taken by Oklahoma, and in this state the production of oil is complicated by high gas pressure to a greater extent than in most other oil fields.

Northern Louisiana¹ still remains an important producer and recently some strong gas fields have been developed in California.

Solid and Semi-solid Bitumens

Under this heading are included: (1) Bitumens of a more or less solid character, which occupy fissures in rocks or in rarer cases, basin-shaped depressions on the surface, and (2) bitumen of viscous character, or *maltha*, which oozes from fissures or pores of the rocks, and sometimes collects in pools on the surface.

¹ Much of the gasolene gas is used to make carbon black.

Since the first class is found filling fissures or associated with them, they may be called *vein bitumens*.

Vein bitumens. — There are several varieties of vein bitumens, all of which are black or dark-brown in color, usually have a pitchy odor, and burn easily with a smoky flame. They are insoluble in water, but soluble to a varying degree in ether, oil of turpentine and naphth: They are closely related chemically, and in their mode of occurrence, but they differ somewhat in their behavior towards solvents, as well as in their fusibility. Their specific gravity ranges from 1 to 1.1.

It may be added that all authorities do not regard all of the substances included under this head, as bitumens.¹ Some of them, as albertite and wurtzilite, are not so considered by Richardson,² because as he states they are “not soluble to any extent in the usual solvents for bitumen, nor do they melt at comparatively low temperatures, nor dissolve in heavy asphaltic oils.”

ELEMENTARY ANALYSES OF BITUMENS AND MALTHA

	1	2	3	4	5	6	7	8	9	10
	Ozokerite, Utah.	Maltha, Car- pantera, Cal.	Impsonite, Oklahoma.	Grahamite, W. Va.	Grahamite, W. Va.	Albertite, Nova Scotia.	Gilsonite, Utah.	Gilsonite, Utah.	Wurtzilite, Utah.	Lake Pich. Trinidad,
C	85 25	85 72	86 57	76 45	59 20	86 04	88 30	89 28	80 00	83 68
H	15 09	11 83	7 26	7 83	5 77	8 96	9 96	8 66	12 23	10 84
N		1 21	1 48	tr.	1 01	2 93	} 0 32	0 79	1 78	0 45
O			2 00	13 46	14 68	1 97			1 79	5 83
S.		1 32	1 38	tr.	tr.	tr.	1 32	1 79	5 83	5 10
Ash			1 31	0 10	19 34	0 10	0 10			
Moisture										

1, 8, 9, 10. Richardson, "Nature and Origin of Asphalt," 1898. 2. Munic. Eng. Mag., June-August, 1897. 3. Amer. Jour. Sci., Sept., 1899, p. 221. 4. Wurtz, analyst, Amer. Jour. Sci., iii, VI; 415, 1873. 5. Hite, analyst, Geol. Soc. Amer., Bull. X, 283, 1899. A proximate analysis made on another sample gave 1.13 sulphur. 6. Trans. Amer. Philos. Soc., Phila., 853, 1852. 7. Jour. Frankl. Inst., CXL, No. 837, Sept., 1895.

On the other hand, Peckham³ includes under asphaltic coals, the vein bitumens grahamite, albertite, gilsonite, etc., which he states “yield paraffin on distillation.”

The terms asphalt and asphaltum are considered as synonymous by many. Peckham⁴ gives it as the solid form of natural bitumen, while Richardson, in practical agreement with him, includes under

¹ Day calls them pyrobitumens.

² Modern Asphalt Pavement, p. 107.

³ Solid Bitumens, p. 77, 1909.

⁴ l. c., p. 79.

asphalts, "all solid native bitumens which are in use in the paving and other industries." Specifically, he says, "true asphalt is sharply differentiated from several of the bitumens which are used industrially under this designation, such as gilsonite and grahamite."

The Committee on Standard Tests for Road Materials, in its report to the American Society for Testing Materials, defines asphalts as "solid or semi-solid native bitumens, solid or semi-solid bitumens obtained by refining petroleum, or solid or semi-solid bitumens which are combinations of the bitumens mentioned with petroleum or derivations thereof, which melt upon the application of heat and which consist of a mixture of hydrocarbons and their derivations of complex structure, largely cyclic and bridge compounds."

Asphaltenes. — The committee define these as the components of the bitumen in petroleum, petroleum products, malthas, asphalt cements and solid native bitumens, which are soluble in carbon disulphide but insoluble in paraffin naphthas.

The following are some of the more important types of the purer bitumens, which occur mostly in vein form.

Albertite. — A black bitumen with a brilliant lustre and conchoidal fracture, a hardness of 1 to 2, and specific gravity of 1.097. It is barely soluble in alcohol, and dissolves to the extent of 4 per cent in ether and 30 per cent in oil of turpentine.

The material was worked in New Brunswick, but was too valuable to use in pavements, and the deposit appears to be exhausted.

Grahamite. — This is a brittle, black bitumen with a hardness of 2 and specific gravity of 1.145. It is slightly soluble in alcohol, partly so in ether, petroleum and benzole, but almost completely in turpentine. Carbon disulphide and chloroform dissolve it completely. It occurs in veins but never in large amounts.

According to Richardson¹ it is differentiated from the asphalts and gilsonites by the fact that it yields from 30 to 50 per cent fixed carbon on ignition. It is called asphaltite and gilsonite by some.

Grahamite has been found in West Virginia, southeastern Oklahoma, and Colorado, but the deposits are hardly large enough to be of much use in the paving industry.

Gilsonite or Uintaite is a black, brilliant bitumen, with conchoidal fracture, hardness of 2 to 2.5 and specific gravity of 1.065 to 1.067. It is equally soluble in cold carbon tetrachloride and carbon disulphide, thus differentiating it from grahamite and some of the residual pitches. According to Richardson it is "readily soluble in the heavy

¹ l. c., p. 205.

asphaltic residues from California and Texas petroleums, and when mixed with these in the proper proportion, makes a material which is extremely rubbery and more or less elastic. It possesses little ductility, however, and in this respect differs from similar preparations made with asphalt." Utah is the most important producer.

"The material is used chiefly in the manufacture of Japan varnishes, in water-proof cement for coating reservoirs, and in insulating materials.

Glance Pitch. — The name is applied to a somewhat widely-distributed bitumen of which the best supplies come from East Syria and the Dead Sea. It is not used in the paving industry.

Manjak. — This is a bitumen found only on the Island of Barbadoes. It is of high purity, black color, and brilliant lustre, related probably to grahamite. It is said to be of no value in the paving industry.

Maltha. — Under this term are included viscous, liquid, natural bitumens, which correspond in consistency to the artificial residuums, but are usually denser.

Richardson¹ claims that they are rarely of a suitable character for use as a flux because on heating they are generally rapidly converted into a harder material by the loss of volatile hydrocarbons.

Maltha is not known to occur in large deposits in the United States, although it is somewhat widely distributed in the California oil fields.

Trinidad lake asphalt. — This represents a type of deposit not found in the United States, but occurs in the famous pitch lake on the island of Trinidad, off the coast of Venezuela.

The deposit appears to occupy a basin-shaped depression of about 100 acres, and the pitch has evidently oozed up from below, for borings show that it occupies a crater-like depression in sandstones which are more or less impregnated with bitumen. An analysis is given in the table on p. 585.

Trinidad asphalt has to be dried and agitated with steam before use. The refined material has a specific gravity of 1.4, dull lustre, conchoidal fracture, and hardness of 2. It contains about 56 per cent of bitumen soluble in carbon disulphide.

Bituminous Rocks

Under this heading are included consolidated and unconsolidated rocks, whose pores are more or less completely filled with bituminous matter. In some cases the material is petroleum, and then it is

¹ l. c., p. 122.

possible, though not always commercially practicable, to distil the oil from the rock. In other cases the pore filling is either maltha or asphalt, and the material is sometimes used for paving purposes.

Bituminous rocks may be classified according to the character of the rock as bituminous sands or sandstones, bituminous limestones, shales and schists. The amount of bituminous matter in the rock varies, and as a rule is not large, as the table of analyses given below shows.

Some difference of opinion exists as to the value of bituminous rocks for paving purposes. The advocates of this material claim that the



FIG. 213. — Map of asphalt and bituminous rock deposits of the United States. (After Eldridge, U. S. Geol. Survey, 22d Ann. Rept., IX.)

bitumen and rock occur practically mixed by nature, requiring only crushing (if the rock is hard), heating and spreading. Cases are quoted also in print of bituminous rock pavements which have given excellent satisfaction.

As against this we hear that the character of bituminous rocks is variable, that the texture of the mineral grains is not always such as to compact to a tight mass, and that the bituminous matter is sometimes maltha and not asphalt, which becomes brittle with time.

A mixture of bituminous limestone and bituminous sandstone has sometimes given better results than the sandstone alone. In France bituminous limestone has been successfully used for paving purposes. Bituminous rocks are widely distributed in the United States (Fig. 213).

In Kentucky asphaltic sandstones occur at several localities but the most important deposits are in Edmonson county. The stone is crushed, spread on the road and rolled cold.

In Oklahoma a number of quarries of bituminous sands and limestones have been opened in the Buckhorn district east of the Washita River and near Rock Creek, but their output is small.

In California bituminous sands occur near Santa Cruz, Santa Barbara and San Luis Obispo but are now little worked.

The following data are given by Richardson, showing the percentage of bituminous matter and texture of a number of rocks.

BITUMINOUS ROCKS FROM UNITED STATES

	1	2	3	4	5	6	7	8	9	10
Bitumen soluble in CS ₂	9.1	7.7	11.1	8.2	11.8	13.2	11.4	11.4	5.9	7.5
Passing 200 mesh-sieve	3.9	7.2	13.0	18.8	1.2	8.6	1.5	4.4	44.1	18.5
" 100 "	35.0	26.6	48.0	9.0	5.0	5.2	4.1	6.1	10.0	14.0
" 80 "	36.0	26.0	23.0	18.0	16.0	12.0	12.0	16.1	5.0	21.0
" 50 "	15.0	29.4	5.0	16.0	59.0	40.0	35.0	44.0	9.0	25.0
" 40 "	1.0	2.5	0.0	4.0	6.0	13.0	20.0	9.6	7.0	7.0
" 30 "	0.0	0.4	..	3.0	1.0	5.0	11.0	5.0	7.0	2.0
" 20 "	0.0	0.2	..	8.0	0.0	2.0	4.0	3.0	6.0	3.0
" 10 "	6.0	0.0	1.0	0.0	1.0	6.0	2.0
Retained on 10 mesh-sieve	9.0

1. Bituminous sand, Soldier Creek, Carter County, Ky. 2. Same, Breckenridge County, Ky. 3. Bituminous sand, Buckhorn District, Indian Territory. 4. Surface mixture made from bituminous sand and lime rocks from Oklahoma. 5. Bituminous sandstone near Ardmore, Oklahoma. 6. Bituminous sand, richest rock, Side Hill quarry, Santa Cruz, Cal. 7. Poorer rock, same quarry. 8. Bituminous sand, San Luis Obispo, Cal. 9. Bituminous limestone, Seyssel, France. 10. Bituminous limestone, Vorwohle, Ger.

Oil Shale

Oil shale is a shale containing bituminous matter known as *kerogen*, which on destructive distillation yields oil and tarry matters resembling petroleum. Oil shales have been worked in Scotland for a number of years, but not in the United States. In the latter country the most important deposits occur in Utah and Colorado. They are hardly to be regarded as a commercial source of oil at present, but may become so in the future.

To be of commercial value an oil shale should yield from 30 to 60 gallons of oil per ton of shale, and ammonia, the latter by-product serving to support the cost of mining and treatment. It is converted into ammonium sulphate with sulphuric acid.

References on Petroleum and Natural Gas

1. Campbell, Econ. Geol., VI, p. 363, 1911. (Theories of Origin.)
2. Clapp, Ibid., IV, p. 603, 1909. (Origin.)
3. Clapp, Geol. Soc. Amer.,

Bull. XXVIII, p. 553, 1917. (Origin.) 4. Collom, U. S. Bur. Mines, Bull. 209. (Prospecting and testing for oil and gas.) 5. Clarke, U. S. Geol. Surv., Bull. 770, p. 731, 1924. (Composition.) 6. Day, David T., Editor in Chief, Handbook of the Petroleum Industry, New York, 1922. (Wiley & Sons.) 7. Emmons, Geology of Petroleum, New York, 1921. (McGraw-Hill Co.) 8. Garfias, Petroleum Resources of World, 1923, New York. (Wiley & Sons.) 9. Hager, Dorsey, Oil Field Practice, New York, 1926. (McGraw-Hill Book Co., Inc.) 10. Redwood, Sir Boverton, Petroleum, 4th edition. (Van Nostrand.) 11. Ries, Economic Geology, 6th edition, 1930, New York. (Wiley & Sons.) 12. White, Geol. Soc. Amer., Bull. XXVIII, p. 728, 1917. (Origin.) 13. Ziegler, Popular Oil Geology, 2nd edition, 1920, New York. (Wiley & Sons.) 14. Hager, D., Practical Oil Geology, 3rd edition. 15. Ver Wiebe, Oil Fields of the United States, 1930, New York. (McGraw-Hill Co.)

Many of the bulletins of the United States Geological Survey contain papers on special districts.

The following state geological surveys have issued special reports on petroleum or natural gas: Alabama, California, Illinois, Indiana, Kansas, Kentucky, Michigan, New York, Ohio, Oklahoma, Pennsylvania, Tennessee, West Virginia. Also bibliographies on petroleum, issued at intervals by U. S. Bureau of Mines.

See also special reports by Department of Mines, Canada, both Mines Branch and Geological Survey.

Many excellent papers in proceedings of American Association of Petroleum Geologists.

References on Solid and Semi-solid Bitumens and Oil Shale

1. Ashley, U. S. Geol. Surv., Bull. 641, 1917. (Oil shale c. U. S.)
2. Eldridge, U. S. Geol. Surv., 22nd Ann. Rept., Pt. I, 1901. (Distribution in U. S.) 2a. Gavin, U. S. Bur. Mines, Bull. 210. (Oil shale, history and technology.) 3. Ells, Dept. Mines, Canada, Bulletins 55 and 1107, 1910. (Bituminous shales, Nova Scotia and New Brunswick.)
4. Winchester, Econ. Geol., XII, p. 505, 1917. (Oil shale in U. S.) 5. Gosling, Sch. of M. Quart., XVI, p. 41. (Ozokerite.) 6. Hertle and others, Report on Asphalt Paving by Commissioner of Accounts of New York City, 1904. 7. Peckham, Solid Bitumens, New York, 1909. (M. C. Clark Pub. Co.) 8. Richardson, The Modern Asphalt Pavement, 2nd edition, N. Y., 1908. (Wiley & Sons.) 9. Abraham, Asphalts and Allied Substances, 2nd edition.

CHAPTER XVII

ROAD FOUNDATIONS AND ROAD MATERIALS

In the construction of roads, especially in the country, the engineer should consider two factors; namely, (1) the geological conditions which may affect the permanence and stability of the road bed, drainage, etc., and (2) the kind and character of rock to be used for the road, whether sand, gravel or crushed stone.¹ What may be said under the first head applies equally well to rail and wagon roads, as both are affected by the same set of geological conditions, and unless specifically stated to the contrary this will be understood to be so.

ROAD FOUNDATIONS

Kind of rock. — In the construction of cuts either on or through a hillside, it is necessary to consider the character of the rock and its structure. Some rocks are hard, massive and therefore expensive to blast, while others are soft, or contain joint or stratification planes, and hence are easy to remove. Gravels, sands, clays and even shales (if not too hard) can be attacked with the steam shovel. In many cases the material removed from the cut can be utilized for fills.

Depressions filled with peat often give trouble, more with railroads than with wagon roads, because of the yielding character of the material, which has not always sufficient strength to hold up the road bed, and may require much and continual filling to keep the top of the sinking material at proper grade. Bogs on hillsides give similar trouble and moreover are usually springy.

Clay sometimes causes much trouble, especially on railway lines, for two reasons: (1) If wet and on a slope, it shows a tendency to slide, even though very slowly; and (2) since clay expands when wet, and shrinks when dry, the heaving of soil is likely to affect the road, and in the case of tracks to throw them out of alignment.

In the province of Alberta, Canada, for example, there are certain clay formations which have given the railway engineers considerable

¹ The use of asphalt is referred to in Chapter XV, and the use of cement and concrete hardly lies within the field of this book.

trouble, because the material absorbs a large amount of water, and increases in volume.

Rock structure. — In igneous rocks, joint planes are usually present; in metamorphic rocks, joints and sometimes stratification and foliation planes; while in the sedimentary ones both joints and stratification planes occur. A rock mass which is unsupported may slide along either type of plane, and this fact should not be overlooked in the construction of rock cuts (Chapter VII).

Take, for example, the case of a slate whose cleavage planes are inclined at right angles to the line of the road. On the side of downward dip the face of the cut can be quite steep, but on the other side it should be sloping if possible and parallel with the dip, otherwise slips of rock are liable to be frequent.

If much water seeps along these planes, and the rock is located in a region of frost, the tendency to loosen pieces of it will be great...

Valley crossings. — The character of the underground structure has to be considered here in connection with bridge foundations. Piers for railroad bridges are often of large size, those for wagon bridges not usually as great, but in either case it is essential that they rest on firm ground. The material on the sides of a valley is sometimes of the character of slide material, which does not remain firm under great weight.

In other cases the beds may dip towards the stream, and contain slippery layers here and there in the section. If now a large bridge pier is placed on such a mass, the weight of it may cause movement along some of the slip planes, unless the precaution has been taken to prevent it.¹

Filled valleys are not uncommon (p. 441). In some cases these contain tightly packed sand and gravel which give no trouble. In other cases the material is peaty (see above), or in still other instances a comparatively firm surface bed of sand and gravel may be underlain by wet clay or quicksand.

Embankments constructed across a valley filling sometimes load it up to a greater degree than it can stand, so that the fill settles down. One cannot tell, without boring or test-pitting, how thick the filling is; and, moreover, the deepest part of the original rock bottom of the valley is not necessarily under its central portion.

Slope of cuts. — This should be carefully considered in order to insure stability of the sides of a cut and prevent constant slides. Firm

¹ *Engineering News*, XXXIX, p. 278, 1898, and *Railroad Gazette*, XL, p. 197, 1906.

rock can usually be left standing with a steep face, but unconsolidated materials, like sand and gravel, must be given their proper angle of repose, remembering that moisture in material like clay increases its tendency to assume a lower angle. The same material in a dry climate will often stand up better than in a moist one. On p. 371 will be found the allowable slopes suggested for different kinds of rock.

Along many lines of railway, there are often clay cuts which have to be constantly watched, because of their tendency to slide down on the track.

Another cause of sliding in a cut is the presence of alternating hard and soft beds. Take the case of sandstone interbedded with soft shale. As the latter weathers back, the sandstone beds are robbed of their support and fall down.

The subject of sand dunes in their relation to road work need simply be mentioned here by way of reminder, since it has been discussed in Chapter II.

Drainage. — If the foundation of a road is not of such character as to be self-draining, some means must be provided to accomplish this artificially. Before constructing a road, therefore, the character of the foundations with respect to its moisture-holding qualities should be investigated. Clay, for example, has strong capillary power; it absorbs moisture and holds it, and therefore requires artificial drainage.

Sand on the contrary, unless very fine-grained, will permit the water to drain off if it can do so. The permeability and capillarity of these materials can be tested by bringing a sample of known volume in contact with a known volume of water, and noting the time that the latter takes to pass through the former. For the permeability test the water should be placed above the material, and for the capillarity test, below, but in contact with it.

ROAD MATERIALS

Raw materials used for highway construction. — These include clay, sand, gravel, crushed stone, asphalt and bituminous rock. The last two have been referred to in Chapter XV. The properties of the others are discussed in the following pages of this chapter, but the mode of occurrence is treated in Chapter II.

The different kinds of unconsolidated and consolidated rock employed in highway construction are rarely transported for long distances, local sources of supply on the contrary being usually drawn upon. It therefore frequently devolves upon the engineer to carefully examine these local sources with reference to the quantity

and quality of the best material, its accessibility and thickness of overburden.

The engineer engaged in road construction, or the preparation of specifications should be familiar with at least the common kinds of rocks. The authors have in mind one case of an engineer who specified syenite (a comparatively rare rock) for use on roads in a certain district where it could not be found, and if used would have to be hauled a long distance. Why he did not call for granite, which would have served the purpose just as well, and could have been obtained nearer by, is not known. The district in which it was to have been used contained plenty of sandstone, and even some limestone.

Clay

Clay is sometimes used for roads, but the different deposits available vary widely in their characters. Some are exceedingly sticky when wet, and dry to a hard, caked, cracked mass, like the *gumbo* of the western and southwestern states. The *black waxy* soil of Texas is of the same character. When very wet it is almost impassable. Other clays are sandy, and do not get quite so sticky. Under continued traffic clay roads, when dry, wear down to a dust that is equally disagreeable.

Much better results are obtained by using a sand-clay mixture, in which case the clay fills the voids between the sand grains. Roads of this type (Refs. 27 and 28) are common in many parts of the South, especially in the Coastal Plain region, and give excellent results, provided the sand and clay are well mixed and the road is properly drained. The sand forms about 70 per cent of the whole. These materials, unless mixed wet, do not reach their best condition in a road until they have been made thoroughly wet by rain several times.

Sand

The texture and varying mineralogical character of sand have already been referred to on page 95. When the grains are less than 1/200 inch in diameter the material is referred to as silt. Many sands have a variable proportion of both silt and clay; indeed, many sands in their natural condition may not only lack uniformity of texture, but are not clean.

For road material it is chiefly the siliceous sands that are employed, and then for the purpose of mixing with gravel or crushed stone.

Sand may be obtained from several different types of deposits, which vary somewhat in their extent and character. Dune sands form de-

posits of considerable extent and as a rule are uniformly fine-grained. Beach sands are often fine, and the grains are commonly rounded. Stream sands, which are found either in the bed of streams, or in bordering terraces, or deltas, may have both clayey and gravelly layers. Residual sands are comparatively rare, and the grains may often be angular. Stratified glacial drift may often contain sand pockets of considerable size, but they most frequently contain considerable admixed gravel. Bank sand is a rather indefinite term applied to any kind forming hills or banks.

Sand alone is not commonly used for roads, as when dug it becomes loose and even dusty. Moist sand, however, packs well, and the sandy beaches along some coasts make excellent driveways when moist.

Gravel

Under the term gravel is included all unconsolidated material that will not pass a 4-mesh sieve. It may occur in nature under a variety of conditions, and these with their characteristics are as follows: 1. Stream-bed gravels. Usually of variable size and rock composition, the pebbles being either rounded or flat, and often mixed with both coarser and finer material, so that it may be necessary to wash and screen them. 2. Flood-plain gravels. Often sandy and pockety, and interstratified with sand. 3. Beach gravels. Usually cleaner than river gravels, may lack binder, and pebbles commonly quite fresh. 4. Delta gravels. Often mixed with coarser and finer material. May pass into sand with depth, and in the case of a large delta become coarser upstream. 5. Glacial gravels, occurring in eskers, kames, or outwash plains. (Refs. 4, 11, 13.)

In some regions the rocks or pebbles in glacial deposits often show considerable similarity to the bed rock of adjoining regions in direction from which the ice came. Gravelly deposits of a residual character are known and are used especially in the South, where the chert, much used in Alabama, is commonly referred to under this name (Ref. 28).

Examination of gravel deposits. — Gravel deposits should be carefully examined to determine their tonnage and extent. This may be done by test pitting or boring and by an examination of cuts and embankments.

Other properties to be considered are shape and lithologic character of pebbles, texture, depth of weathering, approximate quantity of clay, sand, and organic matter. Gravels which are iron-stained usually have better binding qualities. Calcareous gravels may be leached in the upper beds.

Quality of gravel. — The lithologic character of gravels has an important bearing on their behavior under traffic. Some gravel deposits consist entirely of schist pebbles, for example, and grind easily under traffic; others like granite are tough and resistant.¹

Gravel to be of value for roads should not disintegrate under traffic, and the pebbles should be of variable size, so as to have the minimum quantity of voids. A certain amount of fine material sufficient to fill these spaces is desirable. If the gravel is too coarse, some finer material should be added. It is claimed that if a gravel occurs in a somewhat cemented condition in the bank it is likely to make a good road material, and that gravels containing many pebbles of rocks which have good roadmaking qualities are desirable, although the rounded pebbles of a rock have generally less cementing power than angular fragments of the same kind of stone.

The fact that a gravel packs quickly does not necessarily indicate that it will make a good road, for clayey gravels do this, and those containing over 20 per cent of clay are said to make muddy roads.

Iron oxide is a good cement, and many gravels with it pack well under traffic. Examples of such are the *yellow gravels* of New Jersey, and the Lafayette formation of the southern states.

Requirements of gravel. — These as stated by different highway engineers and road commissions vary somewhat. As an example we may take those issued by the Borough of Brooklyn in 1912. "The Hudson River road gravel required shall be what is known as 'double screened' and 'fine' gravel. It shall be free from all foreign substances and meet the following requirements. *Double screened:* Per cent wear not to exceed 5 per cent. Percentage voids not to exceed 45 per cent. The U. S. Dept. of Agriculture cementation test must not be under 25. The percentage retained on a 1½-inch screen not to be greater than 10 per cent, nor less than 5 per cent. The percentage retained on a ¾-inch screen must not be less than 75 per cent. *Fine gravel:* Percentage of substances soluble in water not to exceed 5 per cent. Percentage retained on a ¾-inch screen not to exceed 5 per cent. Percentage in powder form not to exceed 5 per cent.

Tests of gravel. — The quality of road gravel can be determined by several tests as follows: *Mechanical analysis:* This is to determine the percentage of pebbles of different sizes, and is accomplished by passing the material through different size screens and noting the quantity caught on each. That which passes 200 mesh is called powder. *Voids:* The determination is made as on crushed stone (p. 585).

¹ See 8th biennial report of New Hampshire State Highway Dept., which contains a most interesting survey and laboratory tests of gravels in that state.

Quality: This is determined by the abrasion and cementation test as on crushed stone (p. 599). **Solubility in water:** This test, which is often desired, gives the amount of soluble matter obtained by boiling a small sample in water for one hour.

Tests of gravel from different localities.—The following table from Baker (Ref. 1) gives the tests of gravels from a number of different localities. All the samples are said to make a good road material.

TESTS OF ROAD GRAVEL

Size of mesh.	Urbana, Ill.	Decatur, Ill.	Lexington.	Rockford.	Peekskill, N. Y.	Buck Hill.	Rock Hill.	Shark River, N. J.	Oaktown.	Shaker Prairie.	Paducah.	Rosetta.
Per cent caught on 2-in. mesh	0 0	0 0	0 0	6 0	0 0	0 0	0 0	0 0	0 0	0 0	0 0	0 0
" " 1 " "	0 3	1 1	4 8	35 6	2 1	0 0	0 0	0 0	1 5	9 1	20 5	1 9
" " 1/2 " "	9 6	12 2	10 0	23 5	41 3	11 7	3 3	0 8	12 2	12 6	20 5	17 8
" " 1/4 " "	13 0	10 5	8 7	7 4	25 5	11 0	13 4	12 7	18 6	9 1	8 8	11 0
" " 1/8 " "	41 1	14 8	20 2	9 1	17 8	8 4	25 1	33 2	47 5	21 3	13 8	22 3
" " 1/16 " "	12 1	3 9	15 3	3 2	2 2	20 4	14 0	7 4	8 9	9 3	5 2	20 0
" " 1/32 " "	3 9	7 8	15 9	2 7	1 8	8 2	7 2	5 5	3 5	9 3	1 9	10 5
" " passing 1/32-in. mesh	16 2	40 0	21 0	8 7	8 4	20 2	16 3	20 0	6 1	18 8	21 8	10 4
" " in suspension	3 8	9 6	4 2	3 2	0 9	20 0	20 7	20 2	1 8	9 8	7 8	5 9
Total	100 0	100 0	99 9	99 4	100 0	99 9	100 0	99 6	100 1	99 3	99 7	99 8
Per cent voids in washed gravel.	25 5	30 5	27 3	29 6	30 5	26 3	34 0	28 2	25 6	24 3	24 5	25 3

Chert gravel.—This material is available at several localities in the Gulf states, and has given excellent results in Alabama, so that we may quote briefly from the State Geological Survey report (Ref. 28).

"Chert, when of the best varieties, such as Fort Payne chert, is one of the very best of road materials. If it is crushed or broken by hand so that no piece is over two inches in diameter, and the majority even less, it will make a very lasting road. If any fragments of larger dimensions are used, even under the bottom, it will soon wear enough to expose the big lumps, and then you will have a road that is very rough, hard on horses, and especially hard on rubber tires. Chert binds together better than any of the pebble gravels or even limestone macadam, and the best chert road has little or no dust, and consequently little or no mud."

There are, however, several kinds of chert, sometimes found in one county, one very hard and durable, and another soft and chalky. Chert is sometimes found in large solid masses, but this, if blasted, crushed and sized, makes a good macadam road.

Broken Stone

The broken stone used for roads may be of almost any kind of rock, included under the three groups, igneous, sedimentary, and metamorphic. The mineralogical composition and textural properties of the dif-

ferent kinds have already been given in Chapter II and need not be repeated here.

Attention should, however, be called to the fact that the minerals found in rocks may be divided into two classes, viz., primary and secondary. The former includes such minerals as quartz, feldspar, pyroxene, amphibole, biotite, muscovite, calcite, dolomite, garnet, olivine, etc.; the latter, minerals like chlorite, kaolinite, sericite, limonite, serpentine, epidote, and sometimes calcite and quartz. A small amount of some of these secondary minerals may increase the binding power of the rock, but an excess is likely to have the opposite effect.

The weathering qualities are important and depend primarily on the mineral composition, rather than on the hardness and toughness.

Rocks whose grains cohere loosely may have high porosity, as well as low abrasive and crushing resistance. Hard rocks, with tightly interlocked grains, are stronger and better than the preceding class, but may be of low cementing value. Easily soluble rocks, such as limestones, are also bad. Strongly foliated metamorphic rocks, such as schists, are undesirable, because owing to their softness and structure they wear easily.

Field examination (Refs. 3, 11, 13). — An examination of bed-rock deposits should include the following geologic data: Kind of rock, texture, mineral composition, uniformity, form of deposit, structure, thickness of beds (if stratified), abundance of secondary fractures such as joints, cleavage, etc.

In collecting samples for testing, these should be broken off at equidistant points across the strike of the beds (if sedimentary), or across zones of variation (if igneous). Only fresh stone should be taken, and it is desirable to avoid places immediately adjacent to any blast holes, as these may have shattered the rock.

Properties of Crushed Stone

The properties that are commonly considered in the selection of stone for roads are: (1) Abrasive resistance; (2) hardness; (3) toughness; (4) cementing value; (5) absorption; and (6) specific gravity.

Resistance to wear. — The per cent of wear refers to the dust and detritus below $\frac{1}{8}$ inch in size worn off in the abrasion test. The test is made in the following manner: Eleven pounds (5 kg.) of broken rock between $1\frac{1}{4}$ and $2\frac{1}{2}$ inches in size, 50 pieces if possible, are placed in a cast-iron cylinder mounted diagonally on a shaft and slowly revolved 10,000 times.

The French coefficient of wear is obtained by dividing 40 by the per cent of wear. Thus a rock showing 4 per cent of wear has a French coefficient of wear of 10. The best wearing rocks give a coefficient equal to about 20. The number 20 is therefore adopted as a standard of excellence. In interpreting the results of this test a coefficient of wear below 8 is called low; from 8 to 13, medium; from 14 to 20, high; and above 20, very high. Rocks of very high resistance to wear are only suited for heavy traffic.

Hardness. — By hardness is meant the resistance of a rock to the grinding action of an abrasive agent like sand, and it is tested as follows:

A core 1 inch in diameter, cut from the solid rock, is faced off and subjected to the grinding action of sand fed upon a revolving steel disk against which the test piece is held with a standard pressure. When the disk has made 1000 revolutions the loss in weight of the sample is determined. In order to report these results on a definite scale which will be convenient the method has been adopted of subtracting one-third of the resulting loss in weight in grams from 20. Thus a rock losing 6 grams has a hardness of $20 - 6/3$ or 18. Experience has shown this to be the most convenient scale for reporting results. The results of this test are interpreted as follows: Below 14, rocks are called soft; from 14 to 17, medium; above 17, hard.

Toughness. — By toughness is meant the resistance a rock offers to fracture under impact; such, for instance, as the striking blow given by a shod horse. This property is tested in a specially designed machine built on the pile driver principle, by which a standard weight is dropped upon a specially prepared test piece until it breaks. The height in centimeters of the blow which causes the rupture of the test piece is used to represent the toughness of the specimen. Results of this test are interpreted so that those rocks which run below 13 are called low; from 13 to 19, medium; and above 19, high.

Cementing value. — By cementing value is meant the binding power of the road material. Some rock dusts possess the quality of packing to a smooth, impervious mass of considerable tenacity, while others entirely lack this quality. Cementing value should not be confused with the property possessed by Portland cement, which causes it to set into a hard, stone-like mass when mixed with water. The cementation test is made as follows:

The rock sample is ground in an iron ball mill with sufficient water to form a stiff, fine-grained paste. From this paste small briquettes 1 inch (25 mm.) in diameter and 1 inch high are molded under pressure. After thorough drying the briquettes are tested under the impact of a small hammer which strikes a series of standard blows. The number of blows required to destroy the briquette is taken as a measure of the cementing value of the dust. Some rock dusts, when thoroughly dried into compact masses, immediately slake or disintegrate when immersed in water. It is considered that the tendency to act in this way is not a desirable characteristic of a road material, as it would lead to muddy conditions on the road surface after rains. The test is interpreted so that cementing values below 10 are called low; from 10 to 25, fair; from 26 to 75, good; from 76 to 100, very good; and above 100, excellent.

Weight per cubic foot. — The weight per cubic foot refers to the weight of the material in the form of a solid and not as broken stone.¹¹

Absorption. — The absorption is expressed in pounds of water absorbed per cubic foot, according to the formula

$$\frac{W_1 - W_2}{W - W_2} \times 62.37$$

¹ Quoted from U. S. Office of Public Roads report.

in which

W_1 is weight of sample in water after 96 hours immersion, in grams.

W_2 is weight of sample in water, just after immersion, in grams.

W is weight in air, in grams.

62.37 is weight of cubic foot of water.

Specific gravity. — This is determined in the usual manner.

Results of tests. — In the accompanying table are given the average, maximum and minimum figures obtained for the several tests on different rocks, as published by the U. S. Office of Public Roads.

Significance of tests.¹ — The attrition loss seems to be conditioned by texture, mineral composition and degree of freshness of the minerals. The hardest and toughest stones seem to be those containing an abundance of quartz and having a dense fine-grained texture.

The abundant development of secondary minerals produced by weathering is undesirable, but the presence of secondary minerals produced by deep-seated processes, such as uralitic hornblende (p. 19), seems to strengthen the rock.

A study of the tests given in the table below leads to two important conclusions: (1) The number of different kinds of rocks used for road material is very great, and (2) the tests of each kind considering the maximum and minimum figures shows considerable range. One may, therefore, raise the point, whether in engineering specifications it would not be better to demand that the material meet certain tests, rather than to simply call for rock of a certain kind or its "equivalent."

Tests made by the U. S. Bureau of Roads indicate that the percentage wear is less in fresh igneous and metamorphic rocks, as well as those rich in secondary hornblende, than it is in the weathered varieties. But even the slightly weathered igneous rocks may yield better results than limestones, dolomites, calcareous sandstones and cherts.

Plutonic rocks with granular texture are usually of inferior toughness to their volcanic equivalents (rhyolite, basalt and diabase). The sedimentary rocks show a relation between mineral composition and physical properties. Soft non-resistant calcareous rocks, such as limestones, dolomites and calcareous sandstones, are composed largely of calcite and dolomite; they are consequently of inferior hardness, toughness and wearing qualities than the more siliceous sandstones and cherts. The metamorphic rocks in general resemble the igneous ones.

Rocks in which one or more of the primary constituents have un-

¹ Bull. 31, U. S. Bureau Public Roads, has been largely drawn upon for these data.

MAXIMUM AND MINIMUM RESULTS ON ROCK SAMPLES, CORRECTED TO JANUARY 1, 1910

No. of samples.	Name.	Specific gravity.		Weight — Pounds per cubic foot.		Water absorbed— Pounds per cubic foot.		Per cent of wear.		French coefficient of wear.		Hardness.		Toughness.		Cementing value.		Name.		
		Max.	Min.	Max.	Min.	Max.	Min.	Max.	Min.	Max.	Min.	Max.	Min.	Max.	Min.	Max.	Min.			
15	Amphibolite	3.10	2.70	3.00	193	168	1.65	0.04	10.3	1.0	41.7	3.0	19.0	13.5	29	7	235	11	Amphibolite.	
40	Andesite	2.95	2.20	2.70	184	137	1.68	0.59	8.1	1.5	26.0	4.0	19.4	7.9	44	6	500+	11	Andesite.	
83	Basalt	3.00	2.40	2.85	187	150	1.78	0.32	14.7	1.3	30.4	2.7	19.2	5.9	39	6	500+	4	Basalt.	
48	Chert	2.95	2.00	2.55	184	125	1.59	1.10	29.2	2.7	14.6	1.4	19.7	12.7	26	5	500+	2	Chert.	
5	Conglomerate	2.65	2.50	2.80	165	156	1.62	3.71	12.7	3.5	11.6	3.2	18.4	9.3	10	10	500-	20	Conglomerate.	
183	Diabase	3.20	2.60	2.90	200	162	1.81	2.73	0.03	6.3	1.1	36.4	6.4	19.4	12.3	34	4	500+	2	Diabase.
57	Diorite	3.35	2.70	2.85	209	168	1.78	1.03	0.03	7.3	1.6	25.0	5.5	19.4	16.6	38	5	148	5	Diorite.
140	Dolomite	2.90	2.30	2.75	181	143	1.72	9.40	0.07	18.6	1.2	33.3	2.2	18.4	1.8	27	3	179	9	Dolomite.
6	Eclolite	3.65	2.95	3.20	228	184	2.00	0.28	0.10	2.9	1.8	22.7	13.8	18.7	17.4	31	14	130	10	Eclolite.
6	Epidosite	3.30	2.70	3.00	206	168	1.87	1.10	0.22	7.4	2.0	19.6	5.4	19.3	10.7	23	10	83	14	Epidosite.
11	Felsite	2.80	2.50	2.65	175	156	1.65	3.13	0.02	3.4	1.9	21.3	11.8							Felsite.
90	Fieldstone								10.3	2.1	19.0	3.8								Fieldstone.
36	Gabbro...	3.65	2.75	2.95	228	172	1.84	0.97	0.04	5.9	1.3	30.8	6.8	18.8	16.2	23	9	115	6	Gabbro.
115	Gneiss	3.20	2.60	2.75	200	162	1.72	1.24	0.02	16.4	1.7	23.0	2.4	19.3	9.0	25	2	110	1	Gneiss.
168	Granite	3.00	2.00	2.65	187	125	1.65	2.77	0.04	24.6	1.1	37.0	1.6	19.6	13.6	33	2	255	2	Granite.
117	Gravel																			Gravel
573	Limestone	2.90	2.00	2.70	196	125	1.68	13.22	0.02	34.2	1.8	21.7	1.2	19.1	0.0	25	2	500+	10	Limestone.
20	Marble	2.85	2.65	2.75	178	165	1.72	1.04	0.10	14.0	2.5	16.0	2.8	17.3	7.1	23	3	85	15	Marble.
9	Marl																			Marl.
19	Mixed stone								10.3	2.1	19.1	3.8								Mixed stone.
5	Peridotite	3.55	2.6	2.95	221	165	1.54	1.02	0.27	5.3	3.0	13.2	7.6	15.0	13.3	12	9	91	25	Peridotite.
78	Quartzite	3.15	2.50	2.70	196	156	1.68	1.89	0.03	7.6	1.6	24.5	5.3	19.7	16.5	30	5	45	0	Quartzite.
35	Rhyolite	2.90	2.00	2.55	181	128	1.59	7.15	0.03	9.7	1.7	23.0	4.1	19.7	15.3	42	6	500+	10	Rhyolite.
244	Sandstone	3.25	2.00	2.65	203	125	1.65	11.60	0.02	41.7	1.0	40.8	1.0	19.5	0.0	60	2	500+	1	Sandstone.
114	Schist	3.20	2.65	2.90	200	165	1.81	1.35	0.06	18.2	1.3	31.7	2.2	19.0	0.9	35	3	232	5	Schist.
9	Shale	2.70	2.50	2.65	168	156	1.65	4.84	0.50	16.2	3.2	12.6	2.5	17.7	13.9	12	3	367	28	Shale.
43	Slag	3.90	2.00	3.00	243	125	1.87	4.40	0.04	13.5	2.7	14.6	3.0	18.3	10.7	21	3	500+	1	Slag.
45	Slate	3.35	2.60	2.75	209	162	1.72	2.10	0.05	12.4	1.6	24.4	3.2	19.7	1.1	56	1	500+	1	Slate.
26	Syenite	3.05	2.15	2.70	190	134	1.68	4.21	0.08	14.4	1.7	23.5	2.8	19.2	17.3	34	8	375	16	Syenite.

dergone alteration mainly through the action of atmospheric agencies yield powders with proportionately higher cementing values, than those obtained from their unaltered prototypes.

Qualities of Individual Rock Types

Trap and fine-grained basic rocks. — The term is a very comprehensive one, and is convenient for field use. It includes diabase, basalt, andesite and even fine-grained gabbro. Fresh trap rocks are hard, of high abrasive resistance and good cementing value if the traffic is heavy enough to wear the stone. In laboratory tests they give a rather low cementing value.

Fine-grained volcanics. — These show a hardness similar to trap, but are of inferior toughness, probably due to the fact that the mineral grains are not as tightly interlocked. The cementing value is about the same as trap, and they are excellent for light traffic.

Gabbros and other coarse-grained basic igneous rocks. — The wearing qualities of these are not so good as those of the two preceding groups. Their cementing value and hardness about equal those of trap, but they are of inferior toughness. The presence of small amounts of secondary minerals increases the cementing value. These rocks in their general properties stand intermediate between trap and granite.

Granites and other coarse-grained acidic igneous rocks. — These are usually of low toughness and poor cementing value. The percentage of wear is about the same as the coarse-grained basic rocks. Their low toughness appears to be largely due to their texture which is granular instead of interlocking, and to the abundance of platy mica. The finer-grained granites show greater toughness. The low cementing value of granites may be due perhaps to the lack of secondary minerals which develop in basic rocks. Coarse granites should if possible be avoided for roads. If used for road making, they should be placed in the foundation.

Slates and argillaceous schists. — These in general show a moderately high percentage of wear, low hardness and toughness, and only fair cementing value. Their foliated character causes them to split readily into chips, which is objectionable. The clayey varieties grind under traffic.

Quartzite and quartzitic conglomerate. — These have good wearing qualities and toughness, but are of low cementing value. The latter is such an important property, that quartzite alone is not recommended for roads. It can be used if a top dressing of stone with good cementing qualities is employed.

Limestone. — This rock is generally of low toughness, low hardness, high wearing qualities, but good cementing value. If used alone it sometimes tends to crumble and form dusty and muddy roads, but often yields excellent results as a top dressing for rocks of greater hardness and better wearing qualities. The presence of clay increases its cementing value. It is not adapted to heavy traffic.

Shales. — These vary considerably in their nature. Some are soft and clayey, and grind down easily to a mass which is powdery in dry, and muddy in wet weather. Others are hard and siliceous, and give better results; indeed they make a good road if the traffic is not too heavy.

Economic considerations. — As said on an earlier page, crushed stone for roads is not usually hauled long distances. Consequently, the best of the local material is commonly selected. It is of importance to remember in this connection, however, that stratified rocks especially vary from point to point. If a shale formation contains here and there heavy beds of sandstone, suitable for road work, that one should be selected (other things being equal) which contains the least overburden. Or, if none are free from it, select if possible one containing the thinnest top material, or where the slope is gentle, so that the stripping does not increase too rapidly in thickness.

Limestones may also vary in their nature, some being more clayey and of better cementing value than others. This difference may not show on inspection, so that it is well to test samples from different outcrops.

Where igneous rocks are to be employed, and considerable tonnage of stone is required, the precaution should be taken to ascertain that the rock selected is an intrusive rock, or flow of sufficient size, and not merely a dike.

Stone Blocks

Blocks for roadways are usually made of granite, although sandstone, quartzite, and trap are sometimes used. Their essential properties are resistance to weather, and sufficient abrasive resistance to prevent their wearing round and smooth under traffic.

Granite is preferred for blocks because it splits easily. Trap is harder and tougher and hence does not cut so readily, neither does it wear round as granite does, but more uniformly, even though at times somewhat readily. Sandstone cuts easily, and in New York State the Medina sandstone as well as the Potsdam quartzite are said to have been used for pavements (Ref. 2). Much quartzite has also been employed in Chicago.

The size of stone paving blocks is variable. Blanchard (Ref. 2) gives the United States large size standard for a first-class pavement as from 7 to 8 inches deep, 3 to 4½ inches wide, and 8 to 12 inches long. "A light block which is from 4 to 4½ inches deep, 3½ to 4 inches wide, and 6 to 12 inches long, is also used under certain conditions."

There are no special tests for paving blocks.

References on Road Materials

1. Baker, *Roads and Pavements*, Wiley & Sons, New York. 2. Blanchard and Drowne, *Textbook on Highway Engineering*, Wiley & Sons, New York. 3. Agg and Goldbeck, U. S. Dept. Agric., Bur. Public Roads, Bull. 949, 1921. (Sampling and testing highway materials.) 4. Goldthwait and Purington, 8th Bien. Rep., State Highway Dept. N. II., 1920. (Gravels.) 5. Hubbard and Jackson, U. S. Dept. Agric., Bull. 537, 1916. (Physical tests, stones from different states.) 6. Hubbard and Jackson, U. S. Dept. Agric., Bull. 704, 1918. (Specifications for non-bituminous road materials.) 7. Hotchkiss, Tri-State Min. Assoc., Trans. (Geology and good roads.) 8. Lord, U. S. Dept. Agric., Bull. 348, 1916. (Relation mineral composition and rock structure to physical properties of road materials.) 9. Lord, *Ibid.*, Office Pub. Roads, Bull. 37, 1911. (Examination and classification of rock for roads.) 10. Reinecke, *Econ. Geol.*, XIII, p. 557, 1918. (Non-bituminous road materials.) 11. Reinecke, *Good Roads*, XIII, p. 293, 1917. (Determination of value of stone and gravel deposits.) 12. Reinecke, *Can. Geol. Surv.*, Mem. 107, 1919. (Burnt clay roads.) 13. Reinecke and Clarke, *Amer. Soc. Testing Materials*, XVIII, Pt. II, p. 393, 1918. (Methods for sampling and testing bed rock and boulder aggregates or gravel.) 13a. Boswell, *Quarry Managers Jour.*, Nov. 1921. (Geol. characteristics of road stones.) 13b. Nevin, *N. Y. St. Mus.*, Bull. 282, 1929. (Uses glacial sands and gravels.)

Areal Reports

United States. — 14. Ashley, *Tenn. Geol. Surv.*, I, No. 2, 1911. (Chert.) 15. Blatchley, *Ind. Dept. Geol. and Nat. Res.*, 30th Ann. Rept., 1906. (Ind.) 16. Buckley, *Wis. Geol. and Nat. Hist. Surv.*, Bull. 10, 1903. (Wis.) 17. Clark, Johnson and Reid, *Md. Geol. Surv.*, Vols. III, 1899; IV, 1902; V, 1905. (Md.) 18. Hotchkiss and Steidtmann, *Wis. Geol. Surv.*, Bull. 34, 1914. (Limestone road materials.) 19. Landes, *Wash. Geol. Surv.*, Bull. 2, 1911. (Wash.) 20. Leighton, H., and Bastin, U. S. Dept. Agric., Office Pub. Roads, Bull. 33, 1908. (s. e. Maine.) 21. Leighton, M., *Ill. Soc. Engrs.*, 35th Ann.

Rept., p. 73, 1920. (Ill. gravels.) 22. Leighton, M., Wash. Geol. Surv., Bull. 22, 1919. (Wash. sands and gravels.) 23. Lewis, N. J. Geol. Surv., Ann. Rept. 1906, 1907. (Trap in N. J.) 24. Lowe, Miss. Geol. Surv., Bull. 16, 1920. (Miss.) 25. Merrill, N. Y. State Museum, Bull. 17, 1897. (N. Y.) 26. Nash, Tex. Univ. Bull., No. 1839, 1918. (Tex.) 27. Pratt, N. C. Geol. Surv., Econ. Pap. 27, 1912. (N. C.) 28. Prouty, Ala. Geol. Surv., Bull. 11, 1911. (Ala.) 29. Sellards, Fla. Geol. Surv., 1st Ann. Rept., 1908. (Fla.) 30. Sloan, S. C. Geol. Surv., ser. 4, Bull. 2, 1908. (S. C.) 31. Snider, Okla. Geol. Surv., Bull. 7, 1911. (Okla.)

Canada. — 32. Gauthier, Can. Dept. Mines, Summary Rept., 1921, No. 586, 1923. (Can., general survey.) 33. Ledoux, Ont. Bur. Mines, XXVII, Pt. 2, 1918. (Sand and gravel, Ont.) 34. Picher, Can. Dept. Mines, Mines Branch, Bull. 32, 1920. (Que.) 35. Reinecke, Can. Geol. Surv., Mem. 85, 1916. (Surveys in 1914.) 36. Reinecke, Can. Geol. Surv., Summary Rept., 1915, 1916. (Ont. and Que.)

CHAPTER XVIII

ORE DEPOSITS

Nature and Occurrence

THIS chapter gives an outline of the general principles of ore deposits, including the origin, character and more important changes which take place in them, but does not attempt a detailed discussion of their distribution.

Definition of ore deposits.—The term *ore deposits* is applied to concentrations of economically valuable metalliferous minerals found in the earth's crust. The *ore* includes those portions of the ore deposit which contain the metallic mineral in sufficient quantity and in the proper combination to make its extraction both possible and profitable. *Protore* is metalliferous rock too low grade to work.

Ore minerals are those minerals carrying the desired metallic contents which occur within the deposit. Thus galena and cerussite are ore minerals of lead; chalcocite, chalcopyrite, and azurite are ore minerals of copper; and magnetite and siderite are ore minerals of iron.

An ore deposit may contain ore minerals of one or several metals or several ore minerals of the same metal.

Compounds serving as ore minerals.—Only a few elements, such as gold, copper, platinum, and mercury, occur in ores in the native form.

In most cases the metal is combined with other elements, forming sulphides, hydrous oxides, carbonates, sulphates, silicates, chlorides, and phosphates.

Gangue minerals.—Associated with the ore minerals there are usually certain common ones, chiefly of non-metallic character, which carry no values worth extracting. These are the gangue minerals, and of these quartz is the commonest, but calcite, barite, fluorite, and siderite are also common, while dolomite, hornblende, pyroxene, feldspar, rhodochrosite, *etc.*, are found in some ore bodies.

The gangue minerals may be more or less intimately mixed with the ore minerals, or segregated in masses. In the former case, if there is sufficient difference in specific gravity between the ore and gangue minerals, the ore can be crushed, and the two often separated by mechanical concentration. In the latter, the masses of gangue can be

avoided or thrown out in mining. If the ore is low grade, and both ore and gangue minerals in a finely divided condition, leaching may be resorted to as the first step in separating the metal. Or if the metalliferous mineral is magnetic, a process of magnetic separation can be employed.

Origin of Ore Bodies

In an early paragraph, ore deposits have been referred to as natural concentrations. This being so, they must have been concentrated either at the same time as the enclosing rock (*contemporaneous* deposits) or else they have been formed by a process of concentration at a later date (*subsequent* deposits). Most ore deposits belong to the second group, not a few to the first, but the origin of some is still in doubt.

Contemporaneous ore deposits. — These (known also as *syngenetic* deposits) may occur in igneous or sedimentary rocks. Those found in igneous rocks are said to be of magmatic origin, and the field evidence goes to show that they have been derived from the igneous magma by a process of segregation (see also Chapter on Rocks). In other words, as the ore minerals crystallized out they gathered together. In many cases the ore grades into the surrounding rock; in others it is sharply separated from the igneous mass, reminding one of a dike. Indeed, the supposition is that it represents a very basic segregation, which has been forced up from below, subsequent to the intrusion of the igneous rock itself, but not necessarily in all cases before the enclosing igneous mass had entirely cooled.

Most magmatic ores are usually associated with basic igneous rocks. The best-known examples in the United States are the titaniferous iron ores of the Adirondack Mountains, New York;¹ Iron Mountain, Wyo., *etc.* The nickel-copper ores of Sudbury, Ont., and the gigantic Scandinavian iron-ore deposits of Kirunavaara and Luossavaara are other well-known cases. Chromic iron ores are no doubt formed in this manner.

When the contemporaneous deposits are of sedimentary origin they may be either interstratified or surface deposits.

The former have originated from processes similar to those which have formed the enclosing rocks. Some have accumulated by precipitation from sea water or fresh water, while others have had a mechanical origin, having been set free by the disintegration of rocks on the land, the grains being washed into the sea or valleys.

The best example that we have of an interstratified deposit is the Clinton iron ore (hematite) found from New York to Alabama (Fig.

¹ There is now some dispute as to whether all of the Sudbury ore had this origin.

214), as well as in Ohio and Wisconsin. It is of medium grade, and though of great areal extent is not much worked, except in the Birmingham, Ala., region, which is second in importance only to the Lake Superior iron district. The iron ores of Alsace-Lorraine, and the Wabana Island hematite of Newfoundland, are also of this type.

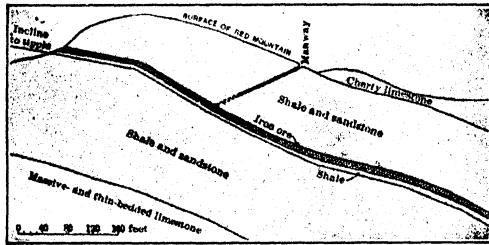

FIG. 214. — Section of Red Mountain, Birmingham, Ala., containing a bedded ore deposit of contemporaneous origin. (After Burchard, Amer. Inst. Min. Engrs., XL, 1910.)

Surface deposits of contemporaneous origin include the placer or gravel deposits so well known to the gold miner. They represent the heavier products of rock decay which have settled down usually in stream channels, and in other cases have accumulated along sea beaches. If the formations from which they are derived contain metallic minerals of durable nature, such as gold, tin, platinum, etc., they become concentrated in the lower part of the gravel deposit. The gold gravels of California and Alaska are of this type.

Tin ore and platinum are also obtained chiefly from placers, but neither is of much importance in the United States.

Subsequent ore deposits. — In the formation of this type of ores (known also as *epigenetic*), the metallic compounds have been gathered from the different rocks, mainly through the agency of water, and deposited under favorable conditions. These facts are susceptible of reasonably strong proof, on the following grounds:

It is a well-known fact that metallic minerals in small quantities are widely distributed through both igneous and sedimentary rocks. In the former they are not impartially distributed, for certain metals seem to favor certain rocks. Thus iron, manganese, nickel, cobalt, chromium, platinum, and titanium seem to favor basic rocks; while tin, tungsten, and some rarer metals favor the acid ones. Although the occurrence of metallic minerals in the rocks of the earth's crust is widely recognized, few probably realize the small percentage existing outside of the concentrated portions of ore deposits, and the following table, which shows the average composition of the earth's crust, will bring out this point, the figures being those given by F. W. Clarke.¹

¹ U. S. Geol. Survey, Bull. 695, p. 35, 1920.

AVERAGE COMPOSITION OF EARTH'S CRUST

Oxygen	47.33	Carbon	.19
Silicon	27.74	Phosphorus	.12
Aluminum	7.85	Manganese	.08
Iron	4.50	Sulphur	.12
Calcium	3.47	Barium	.08
Magnesium	2.24	Chlorine	.06
Potassium	2.46	Fluorine	.10
Sodium	2.46	Strontium	.02
Titanium	.46	All other elements	.50
Hydrogen	.22		

The above figures make clear the interesting fact that, of some twenty metals which are of importance to us for daily use, only three, viz., aluminum, iron, and manganese, are included in the above list, and that the others must be present in very small amounts.

ANALYSES OF MINE WATERS
(Parts per million)

	I.	II.	III.	IV.
SO ₄	406.5	2672.	43.2	2039.51
Cl	6.8	13.	7.9	8.16
CO ₃	13.2		110.5	
NO ₃				
PO ₄	tr.	tr.	tr.	
B ₂ O ₇		tr.		
Br		tr.		
F		tr.		
SiO ₂	23.2	47.7	25.9	43.80
K	7.1	13.1	10.6	70.0
Na	16.2	39.6	36.4	106.27
Li	tr.		tr.	
Ca	151.2	132.5	37.4	187.15
Mg	28.2	61.6	12.25	93.50
Al		83.5	0.4	3.12
Mn	0.5	12.0	0.8	155.58
Ni		0.5		
Co				
Cu	tr.	59.1	tr.	77.05
Zn	0.3	852.	0.2	49.66
Fe'''				
Fe''	1.8	159.8	0.7	164.82
Cd		41.1		
Pb			tr.	3.44
Co ₂			37.2	

I. Green Mountain Mine, Butte, Mont., 2200-foot level fissure in granite, remote from known veins; II. St. Lawrence Mine, Butte, Mont; III. Geyser mine, Custer Co., Col.; IV. Stanley mine, Idaho Springs, Col. All quoted by Emmons, U. S. Geol. Survey, Bull. 529, pp. 60, 62, and 63, 1913.

Mode of concentration.— There seems to be little doubt that water has served as the chief concentrating agent of subsequent ores, for the following reasons:

1 Clarke in a similar table for igneous rocks gives: Ni, .02; Cr, .034; V, .017; Zr, .017; Li, .004 per cent.

1. Water is known to be widely distributed through the rocks of the earth's crust, much of it being in slow but constant circulation. Some of it is surface water that has penetrated to a moderate depth, and some of it is magmatic water that has been given off by igneous rocks while cooling and solidifying.

2. Water if pure has very little solvent power, but if it contains acids or alkalies, or if it is heated or under pressure, its solvent power is increased.

3. Many mine waters contain metallic compounds in solution, and hot springs are even now found, which are depositing such metals as gold, tin, copper or mercury as they reach the surface. The analyses of mine waters given on page 593 are of interest.

Source of concentrating waters. — While all geologists admit that circulating water in the rocks has been an important ore carrier, there has been some disagreement in the past as to whether this transporting agent was mainly of meteoric or magmatic origin.

For many years Van Hise was an ardent exponent of the theory that meteoric water was an important factor in the primary concentration of ore minerals into deposits, but this view is now held by comparatively few geologists so far as insistence on its widespread application to both shallow and deep ore deposits is concerned.

On the contrary, it is safe to say that there is an almost universal belief that the majority of ore deposits owe their primary concentration to magmatic waters, only a few ores being regarded as the products of surface-derived solutions.

On the other hand, it is widely acknowledged that meteoric waters have in many cases played a most important rôle in bringing about a secondary arrangement of the metallic minerals in many ore bodies. (See under weathering and secondary enrichment.)

Concentration by magmatic waters. — Assuming then that magmatic water is the chief concentrating agent of ores, the process of operation may be briefly considered.

These waters often emanate from the magma in vaporous form because of high temperature and pressure conditions, but as the vapors travel farther away from the eruptive where temperature and pressure are less, they are condensed to a liquid condition.

This water, called *juvenile water*, is evidently present in many molten rock masses or magmas, although some have disputed it. However, volcanic gases which have been tested show its presence, and as the rock solidifies, and minerals which have little or no water of combination crystallize out, the water is gradually forced from the cooling and

solidifying mass. With the water there are usually other gaseous substances. As these solutions leave the magma they carry some metalliferous compounds with them in solution, and as they pass through the rocks on their way toward the surface they may add to their burden of dissolved substances.

The facts in general rather seem to favor magmatic waters for the following reasons:

1. Meteoric waters probably do not reach depths greater than 2000 feet, in fact probably not unless they penetrate along some fissure; 2. The lower levels of many deep mines are so dry as to be dusty; 3. Ore deposits reach a much greater depth than that penetrated by surface waters; 4. Igneous rocks are known to expel water during cooling; 5. Most ore bodies are found in regions of igneous rocks, and many have been formed at the same period as the associated intrusives.¹

It should be said, however, that a few ore bodies are undoubtedly primarily concentrated by surface waters, and that secondary concentration is in the vast majority of cases performed by these.

Deposition of ores. — The deposition of ores from solution may occur in two ways, viz., (1) in cavities, and (2) by replacement.

Cavity deposition. — The deposition of ores in the rocks is often due to the presence of cavities through which the ore-bearing solutions pass, at times somewhat freely, and many ore deposits occupy such spaces. These cavities may be formed in different ways, and may occur in all kinds of rocks. Thus they may represent solution cavities in limestones, joint or fault fissures, and interspaces of a breccia, gas and shrinkage cavities in igneous rocks, the pores between the grains of a sedimentary rock, etc.

Precipitation of metals from solution. — If the metalliferous and other minerals were taken into solution at considerable depths where temperature and pressure were high, then as the waters rose towards the surface, where both of these were less, the decreasing solvent power of the solution would cause it to deposit some of the dissolved material. In other cases the deposition of the metals may have been due to the mingling of different solutions, resulting in chemical reactions which yielded insoluble compounds. The contact of solutions carrying sulphates, with carbon, organic matter or other reducing agents, would

¹ Spurr has applied the name *vein-dike* to veins in which he believes the material filling the vein was intruded in a viscous or gelatinous state under great pressure. This he thinks satisfactorily explains the presence of unsupported angular rock fragments (inclusions) in the vein, which could not have remained suspended in a thin aqueous solution, such as is supposed to have filled most veins (Ref. 5).

reduce these to insoluble sulphides. Or, in other cases the approach of a solution to the surface, where it is exposed to oxidizing conditions, could also cause precipitation, as the change of ferrous sulphate to hydrous ferric oxide.



FIG. 215. — Vein filling a fault fissure. Enterprise mine, Rico, Col. (After Rickard, Amer. Inst. Min. Engrs., XXVI, 1897.) Shows irregular banding, also vugs in center of vein. White vein material is quartz; dark, is blende and rhodochrosite.

Where precipitation takes place on the walls of a cavity, the ore and gangue minerals are sometimes built up layer upon layer (*crustified*). There is also a sharp boundary between ore body and wall rock.

Replacement. — It is now widely recognized that under favorable conditions mineral-bearing solutions may attack the rocks through which they move, dissolving them wholly or in part, and depositing other mineral compounds in the place of the mineral matter removed. This is known as *replacement* or *metasomatism*. In some cases the substitution is complete, as when calcite is removed and quartz is deposited; in others it is only partial

as when iron-bearing silicates are decomposed by sulphur-bearing solutions, and pyrite is formed, or when lime silicate replaces lime carbonate.

The ore-bearing solutions enter the rock along channels of access, and attack the minerals, penetrating first along cleavage planes or fracture lines, and then attacking the solid portion of the grains. The change then is a progressive one, which seems to be independent of the specific gravity, or volume of the minerals involved. The simplest and most common type of replacement is that of the calcium carbonate of fossils by silica, or by pyrite.

Replacement is an important process in the formation of ore deposits. Certain rocks such as limestone are

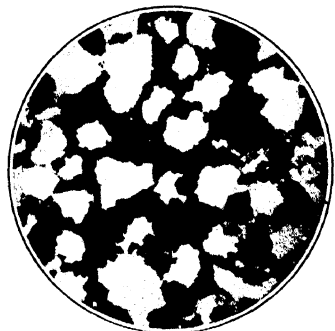

FIG. 216. — Photomicrograph of a section of quartz conglomerate, showing replacement of quartz (white) by pyrite (black) $\times 25$ diam. (After Smyth, Amer. Jour. Sci., XIX, 1905.)

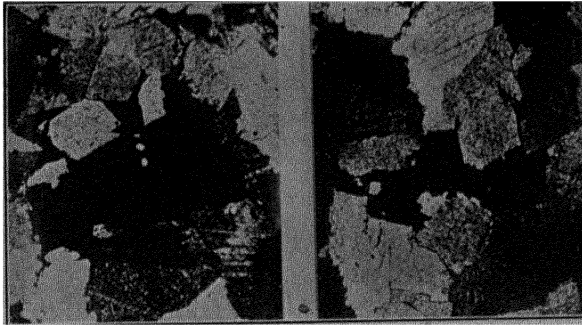

FIG. 217. — Photomicrographs of thin sections of sulphide ore from Austinville, Va., mines $\times 20$ diameters, crossed nicols. Show crystalline granular dolomitic limestone, and the filling of fine cracks accompanied by replacement of limestone grains along crystallographic directions by the sulphides. Very dark irregular areas in center represent sulphides. Re-entrant angles along margins of the sulphides and the spider-like arrangement of the sulphide areas as a whole are well shown. (After Watson, Va. Geol. Survey, Bull. 1.)

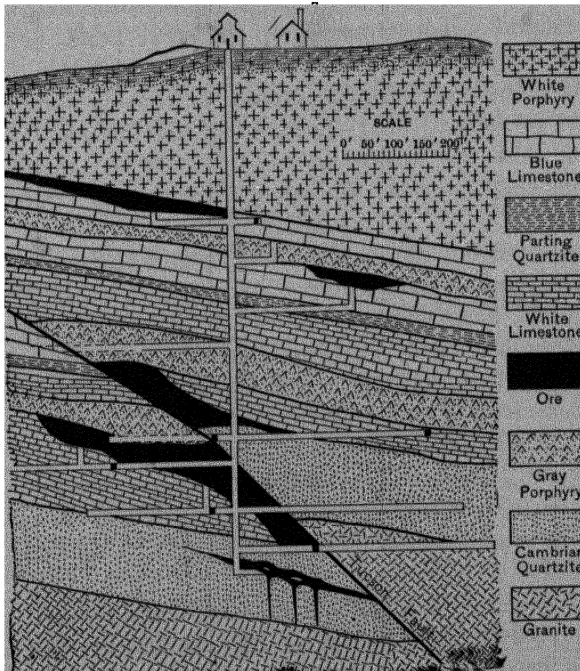

FIG. 218. — Section through the Tuscon shaft, Leadville, Col., showing replacement ore bodies. (After Argall, Eng. and Min. Jour., LXXXIX, 1910.)

more easily replaced than shales or quartzites, but few rocks under proper conditions entirely resist the process. Ferromagnesian minerals like hornblende are replaced more readily than the more acid silicates, such as feldspar.

The process, moreover, is sometimes repeated in the same rock, as in the lead-silver mines of the Coeur d'Alene district of Idaho, where quartz is replaced by siderite, and both in turn by galena.

The boundaries of replacement deposits are usually indefinite, but not necessarily so.

Physical conditions of ore deposition. — It has been pointed out that ore-bearing solutions are given off by igneous rocks, and that they move towards the surface, passing through zones of decreasing pressure, and gradually becoming cooler. Thus we see that there is a gradual change of physical conditions as we go towards the surface.

Starting with this reasonable hypothesis as a basis, and carefully studying all available evidence, we find that many different minerals appear to have a critical level. In other words, certain minerals can exist or form under certain conditions of temperature and pressure, but not under others. Some minerals, on the other hand, persist through a wide range of conditions.

In addition, the wall rocks traversed by the ore solutions may be more or less profoundly and characteristically altered. It must not be supposed that the magmatic solutions arrived undiluted at the surface, for as they approach the latter they no doubt mingle with surface waters.

Close to the igneous rock where pressure and temperature are sufficiently high to heat the water above its critical point (365° C.) it must be in a vaporous form, and the process of deposition under these conditions is termed *pneumatolysis* (gaseous). If deposition occurs when the water is in a liquid form, it is termed *hydatorgenesis* (aqueous).

We may now refer to several types of deposits which are more or less characteristic of certain conditions.

Pneumatolytic deposits. Tin and apatite veins belong to this type. Around the borders of some granitic masses there are found pegmatite veins, carrying cassiterite, wolframite, *etc.*, as well as fluorspar, topaz, and tourmaline.

The wall rocks of such veins have been strongly altered, the feldspar and mica especially being attacked by the water vapors carrying fluorine, and replaced by a mass of quartz, topaz, tourmaline, and lepidolite giving a rock type termed *greisen*. Cassiterite may be present in the wall rock as well as in the vein.

~~Some~~ tin veins are believed to have been formed from a mixture of magma, watery vapor, and gases, given off during the cooling of the igneous mass.

The apatite veins form an analogous group, which is related to basic rocks such as gabbro, and contain chlorine, in place of fluorine, as the prominent mineralizing agent.

They may carry specularite and pyrrhotite as ore minerals, and scapolite, diopside, hornblende, and biotite as silicates.

Contact-metamorphic deposits. — These include certain deposits found in some sedimentary rocks, chiefly calcareous ones, near their contact with igneous intrusions, especially those of a more or less acid character.

The ore deposits are a mixture of silicates and ore minerals. The former when occurring in limestone include garnet, wollastonite, epidote, diopside, amphibole, *etc.*, while in shale or slate we find andalusite, sillimanite, biotite, *etc.*

The common ore minerals are magnetite and specularite, mixed with sulphides such as bornite, chalcopyrite, pyrite, pyrrhotite, and more rarely galena and sphalerite. Gold and silver may be present.

Since these contact-metamorphic deposits are formed sometimes in limestones which in their unaltered condition are practically pure calcium carbonate, it is quite evident that the foreign substances came from the igneous rock.

They were given off in solution in watery vapor, possibly under gaseous or partly gaseous conditions. These were forced out into the fissures and pores of the limestone, and replaced the latter wholly or in part.

The deposits are somewhat bunchy in character and of irregular shape, and as a whole do not extend very far from the contact. Where the beds of sedimentary rock vary in their character, the ore is confined to or more abundant in those which are more easily replaceable, and this fact should be borne in mind when exploiting such ore bodies.

Among the important occurrences of this type may be mentioned the Morenci, Ariz., copper deposits, and the Iron Springs, Utah, iron deposits. Another important locality is that of Bingham Canyon, Utah, although here the main production of the camp now comes from the disseminated ore, found in the porphyry near its contact with the limestone.

Deep seated gold and silver veins. — These represent a class of veins which have probably formed at considerable depths, where temperature and pressure were relatively high. They are usually associated with

granitic intrusions in schists, and show a strong replacement of the country rock. Some copper deposits in schists are of this type.

The characteristic minerals of this type are gold, pyrite, pyrrhotite, galena, zinc blende, magnetite, specularite, ilmenite, quartz, biotite, tourmaline, garnet, hornblende, chlorite, apatite, spinel, and epidote. The amphibolites and micaceous schists show replacement by tourmaline, garnet, green biotite, and epidote. The soda-lime feldspars are unstable under the influence of the vein-forming solutions, and alkali feldspars do not usually form.

Intermediate vein zone ore deposits. — These form a most important group. The deposits are often fissure veins or a related type, and while the minerals frequently fill an open fissure, replacement deposits are not uncommon, and where limestone is the country rock, they may be of considerable extent.

The most important metals in these deposits are gold, silver, copper, lead, and zinc, but the deeper-formed members of the series may carry molybdenum, bismuth, arsenic, and tungsten. Sulphides, arsenides, sulpharsenides, and sulphantimonides are the prominent compounds, while oxides are rare. Quartz is the chief gangue mineral. The country rock shows intense alteration next to the ore, being silicified or sericitized.

The extensive series of copper veins in granite at Butte, Montana, the lead-silver veins in quartzite at Cœur d'Alene, Idaho, and the gold-silver veins of the Georgetown district, Colo., are all prominent examples of this type. Some of the California gold quartz veins, and the famous cobalt-nickel-silver veins of Cobalt, Ont., are also included in this group.

Ore deposits at shallow depths. — The veins of this type are formed comparatively near the surface, as shown by their occurrence in relatively recent volcanic rocks, by the greater number and width of fissures near the surface, and the branching of the upper parts of these fissures. The wall rock shows strong and extensive alteration, this being of a sericitic nature (p. 618) in rocks of medium acidic composition, and of propylitic (p. 617) character in the more basic ones.

In this vein type gold and silver are the prevailing ores, but silver is usually relatively more abundant than in deeper veins with quartz gangue, and the gold is commonly more finely divided.

Quartz is a common gangue mineral, and chalcedony or opal may be sometimes associated with it. Calcite and dolomite are rather abundant while siderite is rare, and both barite and fluorite may be abundant locally. Filling of open spaces is an important process. The Cripple Creek, Col., region is an example of this type of occurrence. Here

the ore occurs chiefly as veins, in Tertiary volcanic rocks, which fill the throat of a volcano in older granites. The veins are narrow, and carry mainly tellurides of gold, with pyrite, quartz, and fluorite as common associates. Galena, sphalerite, tetrahedrite, stibnite, and molybdenite occur sparingly. Propylitization (p. 617) of the wall rock is also shown.

Other districts of this type are Tonopah and Goldfield, Nev.; the San Juan district of Colorado, *etc.*

Cinnabar deposits also belong to this group.

Deposits formed at the surface.—At or near the surface, mineral deposits may be formed by hot springs, but they are not usually of economic importance. Such springs may deposit earthy carbonates as sinter, and silica as opal or chalcedony. Ore minerals developed under these conditions in crystallized form are stibnite, marcasite, and cinnabar, but other sulphides have been detected by chemical means. Calcite, fluorite, barite, and celestite may also develop.

Distribution of magmatic waters.—It is no doubt true that in many cases the waters which came from the igneous magma followed fissures, and either deposited the ores and gangue minerals in them or else invaded the wall rock adjoining the fissure, thus giving more or less tabular deposits.

In some cases, however, the solutions have invaded a large area of the country rock, giving ore bodies of irregular shape and often of large size, but not necessarily great richness.

Hydrothermal alteration.—The hot ascending solutions of varying composition often bring about a most profound alteration of the rocks which they traverse, extracting, it may be, certain elements and adding others. Indeed in many cases the alteration is so extensive that the rock bears no resemblance to its former self.

Alteration is usually most intensive along the fissures which conducted the solution, but if the rock is extensively fractured it is affected over a large area.

The types of hydrothermal alteration which can be recognized are *propylitization*, *sericitization*, *silicification*, *greisenization*, and *alunitization*.

Propylitization.—This process results in a change of the dark silicates to chlorite, epidote, and pyrite, and of the feldspars to calcite, epidote, and quartz. The alteration is most often seen in rocks of intermediate or basic composition, and the rocks so changed are usually of a greenish-gray color with bright green stains of epidote. The feldspars are commonly dull, but the rock texture remains. Propylitization is probably a somewhat shallow process. The volcanic rocks associated with some western gold and silver veins often show strong propylitization.

Sericitization. — This change involves a loss of soda and a gain of potash, Ca , and pyrite, as well as carbon dioxide and fluorine. The resultant product is a fine-grained mixture of sericite, calcite, quartz, and pyrite.

Sericitization is a common type of hydrothermal alteration, which is common near veins, but may pass outward into propylitic alteration. The rocks so altered are white or light yellow in color, and the mass often appears clay-like. Indeed sericite masses are sometimes mistaken for kaolin.

Silicification. — Silicification is a common form of alteration associated with the primary deposition of ores, and is more often noticed in acid than in basic rocks, although it is by no means uncommon in limestones.

The quartz thus formed is cherty in character, and the original structure of the rock may sometimes be clearly preserved. The schist carrying the disseminated copper ore at Miami, Ariz., for example, is strongly silicified.

Alunitization. — This is a somewhat rare type, produced as at Goldfield, Nev., by the action of sulphuric acid solutions on feldspars. The alunite here occurs not only as a massive crystalline constituent of the altered rocks, but also intergrown with pyrite, gold, tellurides, and other minerals in the ore. The fragments of alunitized rock on the dumps give them a whitish appearance.

Greisenization. — The granite walls of many tin veins show a strong and characteristic alteration, the feldspar and muscovite being attacked by water vapors carrying fluorine, resulting in the development of a mass of quartz, topaz, tourmaline, and lepidolite, to which the name *greisen* is applied. Cassiterite may also be present in the altered wall rock.

Forms of Ore Bodies

Ore bodies vary greatly in form, and this character has sometimes been used as a basis for classification, instead of genesis which is more satisfactory. The following are the more important types.

Fissure veins. — A fissure vein can be defined as a tabular mineral mass occupying or closely associated with a fracture or set of fractures in the enclosing rock, and formed either by filling of the fissures as well as pores in the wall rock, or by replacement of the latter or both. In some cases bands of the same minerals may be repeated on both sides of the fissure.

If the vein is formed simply by filling, the ore and gangue minerals are often deposited in successive layers (Fig. 219) on the fissure walls, but if deposition of both goes on simultaneously, the banded-structure (called *crustification*) is absent. The boundaries of a filled fissure are usually sharp.

Replacement veins show great irregularity of width and usually lack well-defined boundaries; they do not, moreover, as a rule show symmetrical banding, or breccias cemented by vein material.

The term *vein material* applies to the aggregate of materials which make up the ore body. A layer of soft, clayey material known as

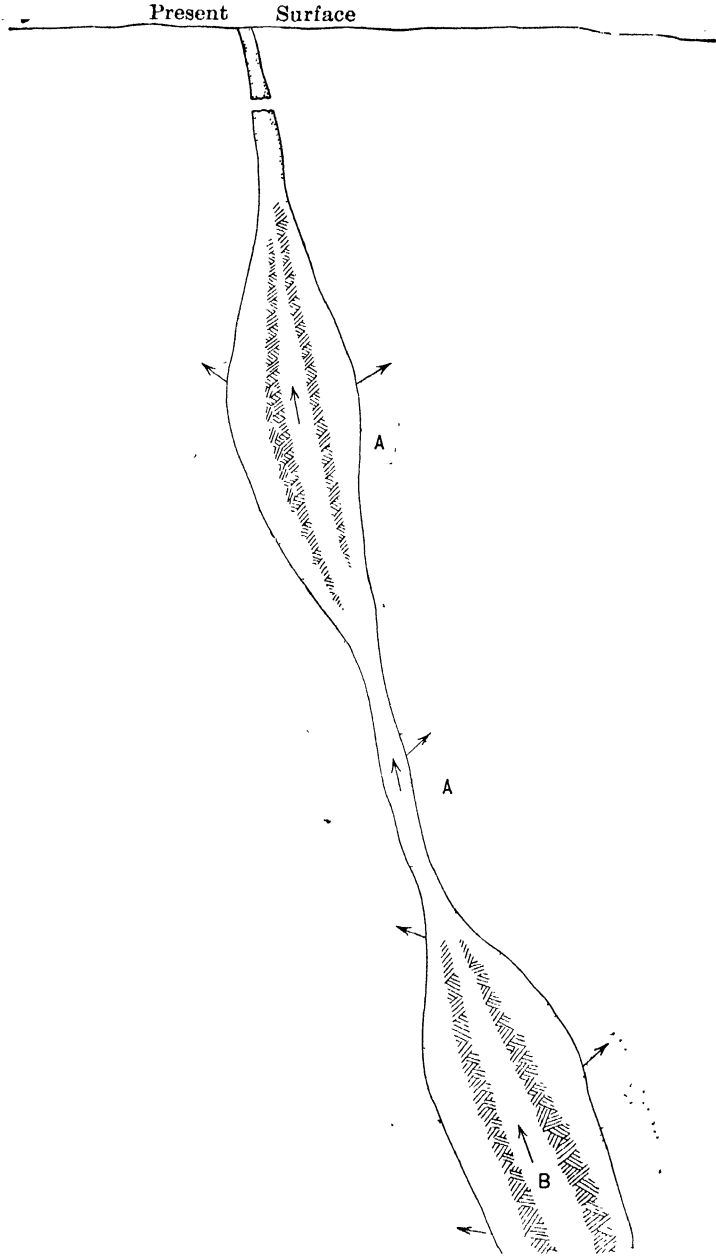

FIG. 219. — Sketch of a fissure vein indicating how deposition may take place on walls of fissure B or by replacement of wall rock A.

gouge or *selvage* sometimes forms between the vein and country rock, and may originate in crushing caused by movement along the vein wall. The ore sometimes follows certain streaks in the vein known as shoots (q.v.), or again it may be restricted to pockets of great richness known as *bonanzas*.

Fissure veins vary in width and persistence; splitting and intersecting veins are also known. If a vein is inclined, the lower wall is termed the *footwall* and the upper the *hanging wall*. *Lode* is a vein consisting of closely-spaced parallel fissures, sometimes accompanied by mineralization of the intervening rock. *Vein system* is a larger assemblage of vein fissures and may include several lodes. *Conjugate veins* are parallel intersecting veins of opposite dip, examples of

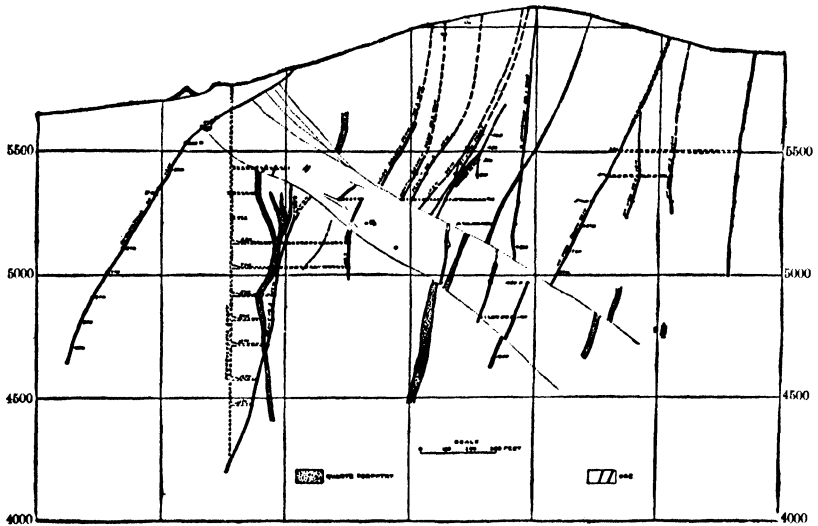

FIG. 220. — Section across veins of Pennsylvania, Rarus, Mountain View, and West Colusa mines, Butte, Mont. A series of steeply dipping veins, broken by faults. (After Weed.)

which are in the Encampment district of Wyoming. *Apex* is the term applied to the top of a vein. It does not necessarily reach the surface, or even the top of the bed rock. *Bedded vein* is a term sometimes applied to a deposit conformable with the bedding, as in the Snowstorm mine, Coeur d'Alene district, Idaho.

Chimney. — This is a term applied to ore bodies which are rudely circular or elliptical in horizontal cross-section, but may have great

vertical extent; the Yankee Girl mine at Red Mountain, Col., is of this type.

Stock. — An ore body similar to a chimney but of greater irregularity of outline.

Fahlband. — A term originally used by German miners to indicate certain bands of schistose rocks impregnated with finely-divided sulphides, but not always rich enough to work. The Homestake ore body at Lead, S. Dak., belongs to this type.

Disseminated deposit. — A type of ore deposit in which the ore minerals occur as small particles or veinlets scattered through the country rock. Though not very abundant, such deposits are sometimes of great size, and in some parts of the west form important sources of copper ore. They are found mostly in schists and intrusives, especially those which have been fissured or shattered. This type of ore is worked at Bingham, Utah; Clifton, Ariz., etc.

Residual deposits. — In the case of some iron, manganese, lead, and zinc ores, the rock containing the primary ore has been weathered to a mass of residual clay. During this process the metallic compounds have been changed to oxidized forms (p. 622) and concentrated in lumps and nodules, stringers or crusts, within the clayey mass. Many of the eastern limonites are of this type. So, too, are some of the lead and zinc ores of Virginia, and the manganese ores of the southern states.

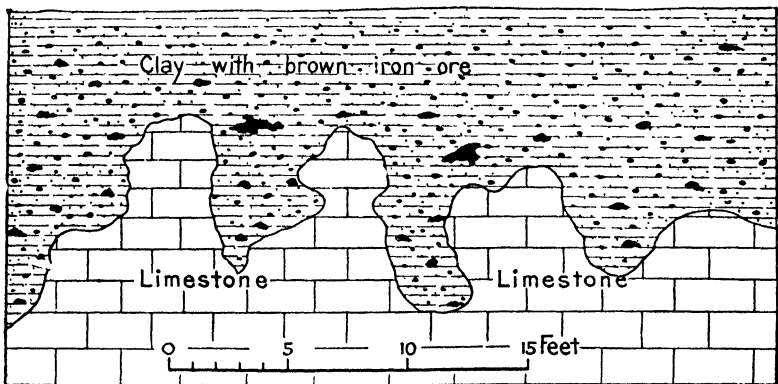

FIG. 221. — Vertical section showing structure of a residual deposit of brown ore, from Reed Island, Va. (After Harder, U. S. Geol. Survey, Bull. 380, 1909.)

Ore shoots. — Few ore deposits are of uniform character throughout; indeed the occurrence of pay ore is apt to be more or less irregular, the richer ore being sometimes more or less localized. These richer

pockets are commonly called *ore shoots*, and they usually owe their formation to some structural feature that has guided the ore solutions.

Thus more abundant fissuring or brecciation, in certain parts of the rock, may operate to promote deposition in those portions of the mass; clay walls may be influencing factors in guiding the ore solutions towards certain spots; or intersecting fissures may permit the mingling of reacting solutions, thereby bringing about more abundant precipitation of the ore at these crossing points.

Several classifications of ore shoots have been suggested. Among them is that of Van Hise, who groups them as follows: (1) Those explained largely by structural features; (2) those formed by the influence of wall rocks; and (3) those formed by secondary concentration by descending waters.

Primary and Secondary Ores

Primary ores are those which have remained practically unchanged by surface agencies since their deposition. Secondary ores are those which have been altered by surface agencies, especially descending meteoric waters. Unfortunately the two terms are not always used in exactly this sense.

Weathering and secondary enrichment. — Weathering has often changed an ore deposit in its upper part, and sometimes to a considerable

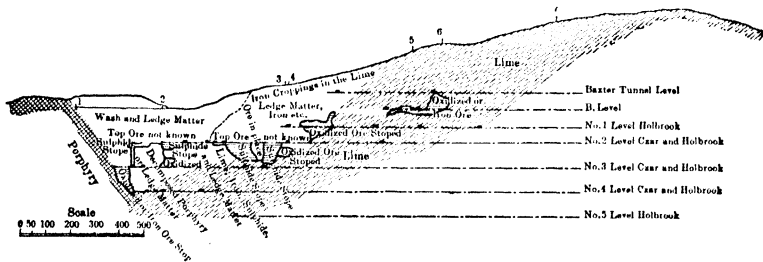

FIG. 222. — Section through Copper Queen mine, Bisbee, Ariz., showing variable depth of weathering. (After Douglas, Amer. Inst. Min. Engrs., Trans., XXIX.)

depth, while the lower-lying portions below the groundwater level are often enriched by secondary processes. The lower limit of the zone of weathering may, however, be very irregular (Fig. 222).

Zones in an ore body. — In passing downward from the surface the following zones may sometimes be distinguished (Fig. 223), although they are not always separately recognizable in all ore bodies.

- Zone of weathering (a) Surface zone of complete oxidation.
 (b) Zone of complete leaching.
 (c) Zone of oxide enrichment.

II. Zone of secondary sulphides.

III. Zone of primary sulphides.

Zone of weathering.— Nearly all minerals are attacked by weathering agents, but the metallic minerals are more easily attacked and more profoundly affected than the non-metallic ones.

The weathering processes involve both chemical and physical changes, but the chemical reactions especially are more intricate in ores than

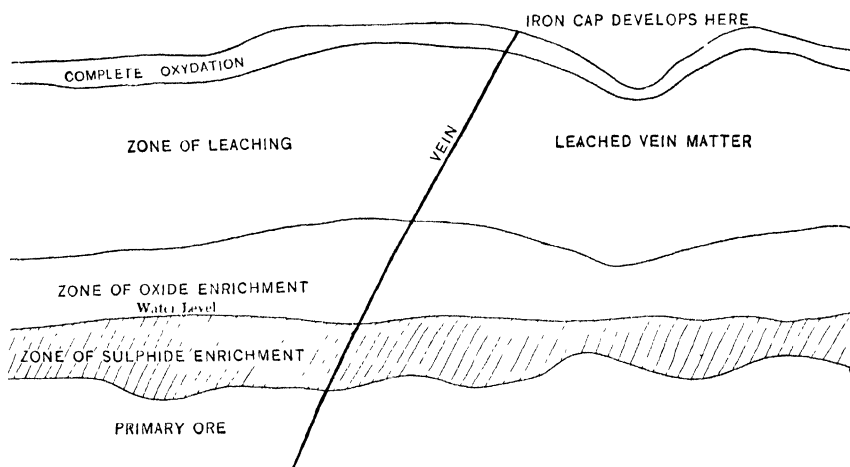

FIG 223.— Section of an ore body showing the several zones that may be developed by weathering and secondary enrichment. (After Tolman, *Min. and Sci. Press*, Jan. 4, 1912.)

they are in the country rock. As a result of weathering, worthless minerals may be removed, leaving the weathered part more porous, so that the richness may be increased, because we have a greater quantity of metals per ton of rock. On the other hand, weathering through solution may remove some of the metallic compounds, leaving the upper part of the ore body impoverished.

The first process in weathering is the breaking down of insoluble sulphides, which takes place above the water level, where moisture and oxygen can attack them, changing them first to sulphates and in some cases finally to oxides or other compounds.

They are not attacked in the same order, and different authorities

do not agree on this point. Thus Weed¹ gives the order of decomposition as arsenopyrite, pyrite, chalcopyrite, sphalerite, galena, and chalcocite, while Beck² states the order as marcasite, pyrite, pyrrhotite, chalcopyrite, bornite, millerite, chalcocite, galena, and sphalerite. The variation in order of decomposition may be due to varying conditions.

Moreover, the oxidation of any one sulphide does not necessarily always proceed in the same manner, as the following equations indicating the change of pyrite show.

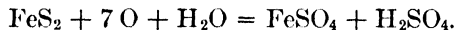
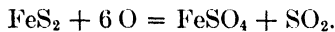
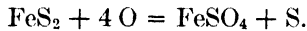

The FeSO_4 in presence of oxygen will be further changed thus:

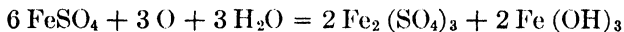

and

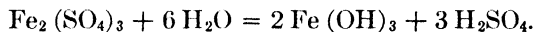

But the ferric hydroxide may break down as follows:

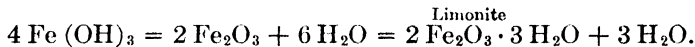

There is a tendency, therefore, for much of the pyrite to be converted into limonite.

While iron sulphide as shown above may oxidize to iron sulphate and sulphuric acid, other sulphides like galena and sphalerite may oxidize to sulphates without liberating any acid. Thus:



or

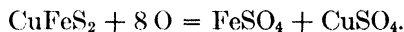

In addition to sulphates, we sometimes have carbonates or silicates formed, somewhat as in the following reactions.

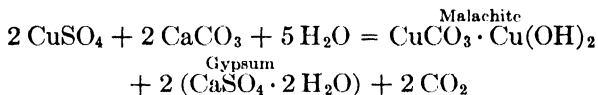

or

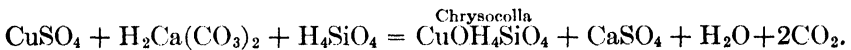

We see from the above that weathering may develop comparatively insoluble compounds like hydrous oxides or silicates, and in some cases carbonates as smithsonite (zinc carbonate), or at other times soluble ones like sulphates. In the upper zone of the belt of weathering, oxidation has been carried to an extreme, and at the surface there is fre-

¹ Trans. Amer. Inst. Min. Engrs., XXX, p. 429, 1901.

² Nature of ore deposits, p. 337.

an *iron cap* or *gossan*, composed of limonite and often with much residual silica as quartz. It may also carry residual gold, silver chloride (in arid regions) or even weathered compounds of lead, zinc, and copper; provided of course these metals are present in the primary ore.

Below this zone may follow one which is more or less thoroughly leached. Then in the lower part of the belt of weathering, or just above the sulphide zone, the minerals are sometimes only partly oxidized, forming oxides, carbonates, silicates, and native elements. Sometimes rich oxidized ores are found in this zone, especially where the wall rock is limestone.

Secondary sulphide zone. — In many ore bodies, rich masses of ore occur below the oxidized zone, which are of secondary character, or

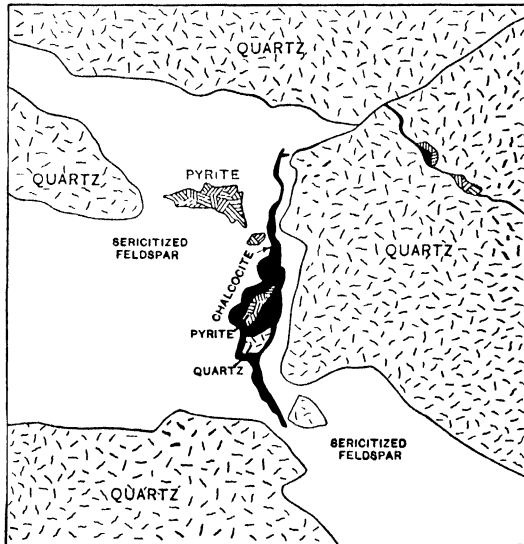

Fig. 224. — Section of ore showing precipitation of secondary chalcocite on pyrite. (After Paige, U. S. Geol. Survey, Bull. 470, 1911.)

there may be a zone of ore which, if not rich, is at all events richer than the primary ore. This is seen most often in copper, gold, and silver, and to a less extent in lead and zinc ores.

It is due to the soluble products of weathering being carried downward, where they (sulphates) react with sulphides and are again reduced to sulphides.¹

¹ There is some difference of opinion among various investigators as to whether secondary enrichment takes place at, below, or above the water level, but probably its largest development in most deposits is below the water level.

This is known as secondary enrichment, and many important ore bodies, such as most of the copper deposits of the West, owe their workable character to this enriching process.

The two equations given by Tolman¹ may be taken as illustrating the reactions which occur in this zone, the sulphate in both cases having been derived from the weathered zone above in solution.

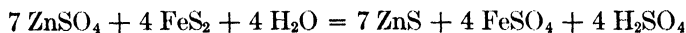

or

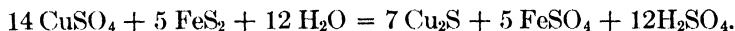

Evidence of this process can be seen to advantage in some copper deposits, where in the secondary-sulphide zone rims of chalcocite surround grains of pyrite.² (Fig. 224.)

Since the position of the secondary sulphide zone is thought to be determined by the level of the water table, it may vary from a few feet in depth to several hundred feet in semi-arid and elevated regions, or in exceptional cases even deeper. Moreover, the thickness of the zone is extremely variable, for the process is affected by various conditions.

If the mass of unweathered ore is dense (impervious) and unfractured the downward migration of the metals is stopped or retarded. Secondary enrichment may also be lacking in arctic regions where the frozen ground prevents downward seepage.

Change of ore with depth.— It has been pointed out that all metallic minerals do not weather with equal rapidity, consequently some may be carried downward more rapidly than others. Thus zinc sulphide weathers more rapidly than lead sulphide, resulting sometimes eventually in an ore deposit which yields chiefly lead above and zinc below. By the operation of similar processes, we may have developed from a copper-gold ore, a gold deposit above and an auriferous copper deposit below.

Gold is leached under favorable conditions. When held in solution as chloride, it is precipitated by ferrous sulphate unless an oxidizing agent, such as manganese oxide, is present, in which case it remains in solution. Gold may, therefore, be carried in an acid solution so long as the higher oxides of manganese are present. The precipitation of the gold from chlorine solution may be caused by native metals, sulphides, organic matter, and other materials.

¹ Min. & Sci. Press, Jan. 4, 1913.

² The recent investigations of L. C. Graton show that the change from pyrite to chalcocite is not always a direct one, but that intermediate sulphides may be formed.

of primary sulphides. — The boundary between the secondary-sulphide zone and that of primary sulphides next below is very irregular and often somewhat indefinite. The primary ore (*protore*) is often too low grade to work. Sections of the ore when examined under the microscope sometimes show that more than one ore mineral has been deposited at a time.

Outcrops of Ore Bodies

Many ore bodies outcrop on the surface. Where the ore is more resistant than the wall rock it may stand out in more or less strong relief, and where it is less resistant than the country rock it weathers more rapidly. In the latter case, its presence might be indicated by a depression. Veins with predominant quartz are usually resistant, while those with predominant sulphides are likely to be the reverse. Strong persistent fissure veins on the surface are not unlikely to continue so with depth, but small, narrow, branching veins are less reliable.

If a vein or other ore deposit of irregular width is more resistant than the wall rock, the wearing down or erosion is likely to stop at the widest part, hence below this the vein may narrow.

If the vein is softer, it may increase in width, and the surface close together after the vein material is weathered out. Indeed, in such cases the position of the vein may be indicated by a gouge-filled fissure.

If a vein outcrops on a steep hillside, the creep of the surface material will carry fragments of the outcropping ledge down the hillside. These become mixed with the surface material and are termed "*float*."

Silicified ledges and limonite gossans sometimes form prominent outcrops.

Distribution of Ore Deposits in the United States

A map showing the occurrence of ore deposits in the United States at once conveys the idea that the useful and precious metals are not uniformly distributed; indeed one is impressed with the predominant variety of metals found in the western states and the practical absence in the several physiographic provinces (Fig. 225) may be briefly referred to.

Coastal Plain. — In this province which borders the Atlantic Ocean and Gulf of Mexico, and extends from Cape Cod to Mexico, there are no metalliferous deposits of commercial importance, except bauxite in

, even though the belt is rich in non-metallic substances, such as clays, sands, phosphates, and marls.

Piedmont Plateau. — West of the Atlantic Coastal Plain is a strip of ancient crystalline rocks, which extends from central Alabama northeastward through New England. The Piedmont Plateau proper is that portion lying south of New York, while the northern continuation is known as the New England Plateau. It represents an ancient plain of erosion, formed at sea level, but since uplifted and dissected by later weathering and stream cutting.

A number of metalliferous deposits of iron, copper, manganese, and gold with some silver, lead, and zinc are found in this belt, but since most of them are chiefly of historic interest, they add with few exceptions little to the total production of the United States. Some of these will undoubtedly prove more productive in the future.

Most prominent among these are the magnetites of southeastern Pennsylvania and the states farther south, and the pyrite, gold, and copper ores of the southern states.

Appalachian Province. — On the western side of the Piedmont Plateau, and extending from about Montgomery, Ala., to Albany, N. Y., is a belt whose parallel ridges and valleys are cut in folded stratified rocks.

This belt is of importance in the metal-mining industry as it carries deposits of bedded (Clinton) iron ore, residual brown iron ores, and manganese, as well as the copper deposits of Tennessee and the lead and zinc ores of Virginia and Tennessee. The bauxite deposits of the Georgia-Alabama-Tennessee district also lie in this province.

Allegheny Plateau. — This consists of a great block of stratified rocks, which begins as a steep eastward-facing slope on the western edge of the Appalachian Province, and dips gently westward to the interior plains, its altitude ranging from three or four thousand feet on the east to the level of the Mississippi Valley on the west.

With the exception of the magnetite deposits of the Adirondack Mountains, which rise above the plateau at its northern end in New York state, there are few metalliferous deposits of importance in this province.

Prairie Plains. — In the central part of the country we have an irregular lowland, which extends from the Gulf Coastal Plain on the south to the Great Lakes on the north. Two areas of somewhat strong relief, lying within this province, are the Superior Highlands on the north and the Ozark region of domed rocks in Missouri and adjoining states on the west and south. This is an exceedingly important province

for it contains the vast iron deposits of the Lake Superior region, the native copper deposits of Keweenaw Point, Mich., and the lead and zinc deposits of the upper and lower Mississippi Valley region.

Outside of these districts few metals have been found.

Great Plains. — This belt lies between the Prairie Plains and the Rocky Mountains, and has a maximum width of 500 miles. Its surface rises from 1,000 to 2,000 feet on the east to 4,000 or 5,000 feet on the west. With the exception of the isolated mass of rocks forming the Black Hills of South Dakota, which contain gold ores, and the mercury area of Brewster County, Texas, the province is singularly free from metalliferous deposits.

Cordilleran Region. — This area includes that portion of the country lying between the foothills of the Rocky Mountains and the Pacific coast. It consists, however, of a number of provinces, most of which are important producers of different metals. The provinces are known as the Rocky Mountains, Colorado Plateau, Columbia Plateau, Basin Range province, and Pacific Mountain province.

In the Rocky Mountains province which consists of mountain ranges and high peaks, with many igneous rocks, a number of valuable ore deposits are found. These include the gold deposits of Cripple Creek, Col., the lead and zinc ores of Leadville, Col., the lead-silver ores of the Cocur d'Alene district, Idaho, *etc.* Copper also occurs associated with other ores.

Not less important is the Basin Range province. This contains important gold and silver ores, associated with recent volcanic rocks, as at Goldfield, Tonopah, and Virginia City, Nev. In this same province also are found the enormous deposits of disseminated copper ores obtained at Bingham, Utah, Ely, Nev., and several points in Arizona.

The Pacific Mountain province is chiefly important as a source of gold quartz ores, such as the Mother Lode of California, and gold-bearing gravels. Mercury has been found at scattered points in the south of the province, and iron ore in the northern portion.

Occurrence of the More Important Ore Types

Iron Ores

In spite of the abundance of iron in the rocks of the earth's crust, there are few ore minerals of the metal. The iron ores of the greatest commercial value are those which occur in great quantity, are favorably located, and easily mined.

quantity of iron ore mined annually in this country is large, and the average grade is higher than that obtained in many other countries, so that if we include our deposits of medium grade the country contains large ore reserves.

Iron-ore minerals. — The ore minerals of iron, together with their composition and theoretic percentage of metallic iron, are:

Name.		Composition.	Per cent, iron,
<i>Magnetite.</i>	Magnetic iron ore	Fe ₃ O ₄	72 4
<i>Hematite.</i>	} Specular iron ore, red hematite, fossil ore, Clinton ore	Fe ₂ O ₃	70 0
<i>Limonite.</i> ¹		2 Fe ₂ O ₃ · 3 H ₂ O	59.80
<i>Siderite.</i>	} Spathic ore, carbonate ore, black-band, clay iron stone, kidney ore . . .	FeCO ₃	48 27

¹ The group name *brown ore* is perhaps preferable as the ore may contain other hydrous oxides.

Pyrite, a very common mineral, is not used as an ore, except in rare cases, and then only after the sulphur has been expelled by roasting. Its chief use is for sulphuric-acid manufacture, although the “blue-billy” iron residue after desulphurizing is used to some extent for the manufacture of pig iron.

Few ores of iron approach in richness the theoretic amount shown above, the deficiency in iron content usually shown being due to the presence of a variable amount of gangue minerals. The impurities which they supply are alumina, lime, magnesia, silica, titanium, arsenic, copper, phosphorus, and sulphur, of which the last six produce a weakening effect on the iron.

Silica occurs in practically all ores, but in variable amounts. It is always high in residual limonites, and these may likewise show high alumina. Pyrite is a common source of sulphur, but in some limonites it may come from gypsum or barite. Manganese, when present, is found mostly in limonite ores, and for certain purposes is desirable. It is also prominent in some Lake Superior ores. Apatite yields the phosphorus. Titanium is prominent only in certain magnetites.

Types of iron-ore bodies. — Iron-ore bodies are of varied form, but many of the important ones known in this country are lens- or basin-shaped in outline. They may be classified as follows:

1. Magmatic segregation deposits, usually of irregular form, but sometimes dike-like in character, Lake Sanford, N. Y.
2. Contact-metamorphic deposits, commonly of somewhat pockety form, although the pockets may be large, Cornwall, Pa.

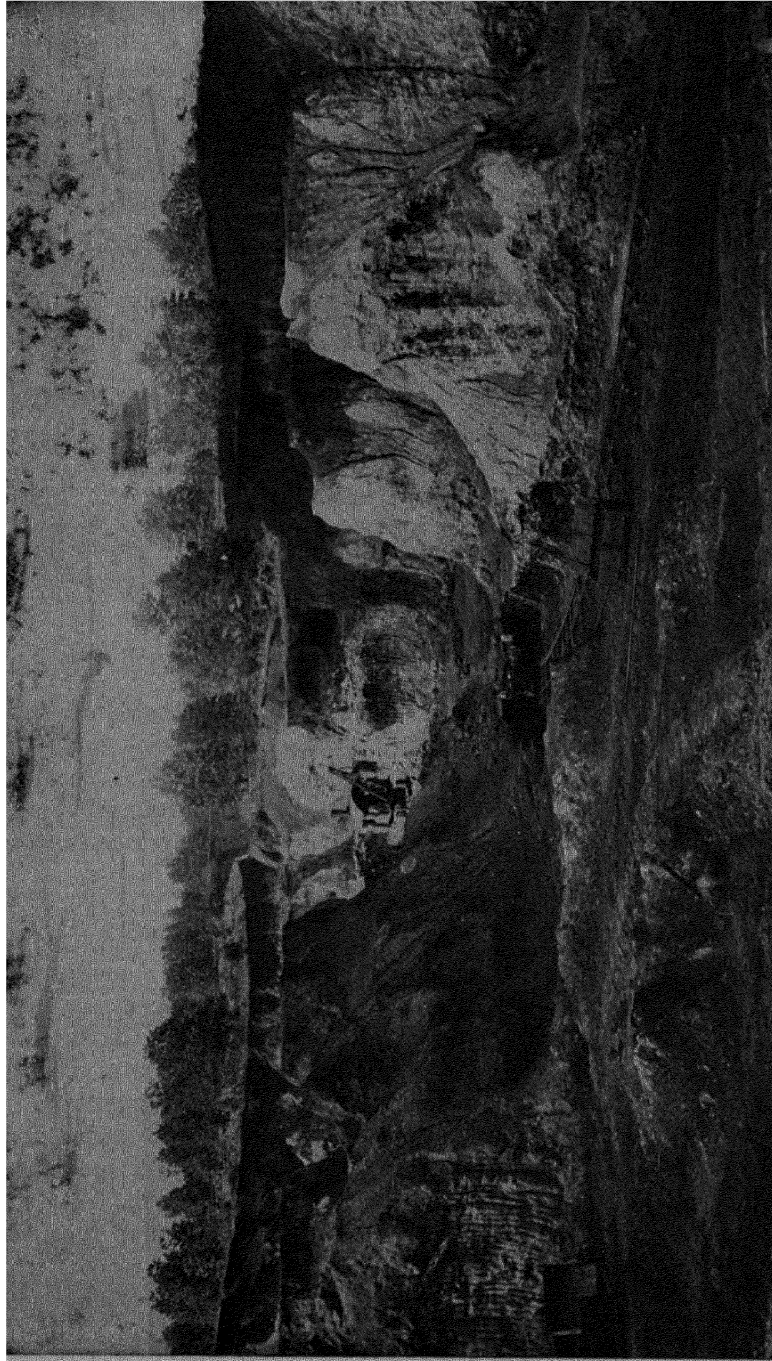

PLATE LXXXVII. — General view of a residual limonite deposit at Ironton, Alabama.

Sedimentary ores of bedded character, like the Clinton ore, and bog ore occurring as nodules in bog deposits.

4. Ores concentrated by meteoric waters, and deposited as replacements in different kinds of rocks. (Some Lake Superior hematites¹ and Oriskany limonites of Virginia.)

5. Residual deposits, as nodules or crusts in residual clays (some Virginia and Pennsylvania limonites).

6. Lenticular masses in metamorphic rocks, of variable origin (some magnetite and pyrite deposits).

7. Gossan ores, as the limonite capping of many sulphide ore bodies.

Magnetite.—Magnetite is black, often granular, and occurs commonly as lenses or disseminations in metamorphic rocks. It sometimes, as in the Great Basin province, may be mixed with hematite or even copper in contact-metamorphic deposits. Deposits of magnetite are also found at times in very basic igneous rock (Lake Sanford, Adirondacks; Iron Mountain, Wyo.), and these are usually formed by magmatic segregation. They run too high in titanium to be smelted in the blast furnace, but could serve for making ferro-titanium alloys.

The most important ore bodies are the non-titaniferous magnetites found in acid metamorphic rocks of the Adirondacks, in New York state, northern New Jersey, and some of the Atlantic states farther south.

Hematite.—Hematite is red to brownish red, steel gray, or even black. It is commonly fine grained, but the specular varieties may be quite coarse. At present it forms the most valuable ore of iron mined in the United States.

Bedded deposits, known as the Clinton ore, are found in the Appalachian province, as well as in New York, Ohio, and Wisconsin. They may show considerable silica and phosphorus, and outside of the Birmingham, Ala., district are not worked very extensively. Here the ore beds which carry from 37 to 54 per cent iron are found in the southeasterly-dipping Clinton formation in Red Mountain. Other bedded deposits are worked at Wabana, Newfoundland, while less important ores occur in Nova Scotia.

In the Lake Superior region extensive deposits of hematite are found, and form the most important source of domestic iron-ore supply.

The formations present in the iron ranges or districts include a complex series of pre-Cambrian igneous and sedimentary rocks which

¹ The original iron formation is a mixture of iron oxide and silica, deposited by magmatic waters.

have been highly metamorphosed and folded. The ores occur in the so-called iron formations, the latter representing alternations of chemically-deposited sediments, consisting of varying mixtures of iron and silica. Since their formation the rocks have been folded and faulted,



FIG. 226. — Map showing distribution of hematite and magnetite in the United States. (After Harder, U. S. Geol. Survey, Min. Res., 1907.)

the iron has been concentrated by surface waters, and in some cases these concentrations changed by metamorphism.

The ores vary from hard blue to soft earthy ones, and some are of very high grade.

Owing to the enormous quantity of ore, its location and the ease with which it can be mined and shipped, the region has become of great importance, and contributes most of the domestic production.

Specular hematite is also found in southeastern Wyoming and in Shelby County, Ala.

In the Great Basin province of the west hematite sometimes occurs associated with magnetite (as at Iron Springs, Utah).

Limonite. — Limonite is never crystalline, and varies widely in its appearance; it is sometimes powdery, or at other times massive, and the latter may be porous, vesicular, stalactitic, or even solid. The color is brown to brownish-yellow on the fracture, but may be black and shiny on the surface.

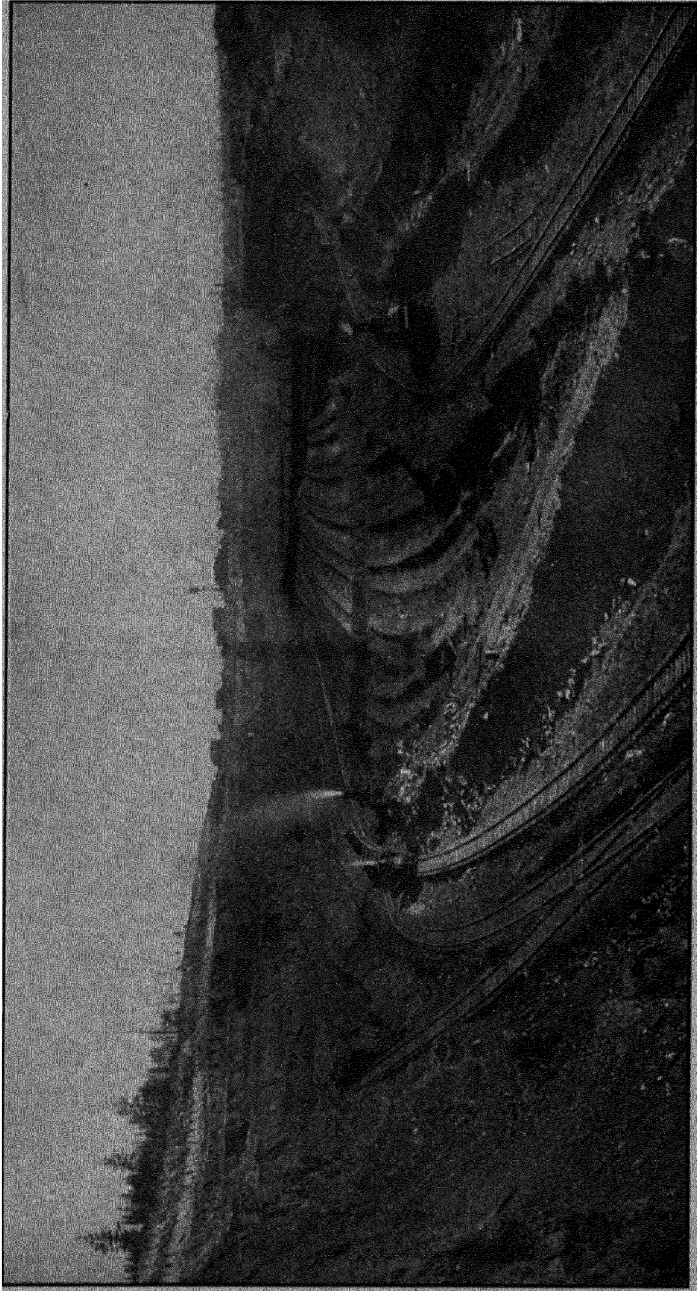

PLATE LXXXVIII. —General view of Mountain Iron mine, Mesabi Range, Minn., showing mining of ore with steam shovels and covering of glacial drift (*a*). (Crandall and Maher, photo, from Ries' Economic Geology.)

(635)

Limonite and the other hydrous oxides of iron may form deposits of several different types. The commonest of these is the residual type, in which nodules of the ore are scattered through residual clay. The ore has to be separated from the clay by washing and screening,



FIG. 227.— Map showing distribution of limonite and siderite in the United States. (After Harder.)

so that the workability of the deposit depends on the quantity of ore in the clay. A second type is gossan limonite, formed by the weathering of sulphide deposits. In the Appalachian belt these are formed from pyrite, or mixtures of the latter with pyrrhotite and chalcopyrite. They have supplied some iron ore in the past.

In the Cordilleran region gossan limonite is found over not a few sulphide-ore bodies, but here the ore may carry some of the precious metals and is of more value as a flux than as an iron ore.

Sedimentary limonite deposited as a chemical precipitate in ponds or swamps is widely distributed, but of no commercial value in the United States, although it has been worked in Canada.

Siderite. — This ore of iron is not of much commercial value, because of the small extent of the deposits and its low iron content. It occurs most commonly as bands or concretions in shales, especially of the coal measures. Such concretions are not uncommon in some clay beds.

Production. — The shipments of iron ores in the United States in 1920 amounted to 69,281,341 long tons, valued at \$285,006,327. This

was a great but probably temporary decrease in 1921. Of the above amount, hematite formed about nine-tenths, magnetite and brown ore each less than three per cent, and siderite about .005 per cent.

Copper Ores

Ore minerals of copper. — While the total number of ore minerals of copper is considerably larger than those of iron, not many of them are of widespread importance. Unlike iron, the ore minerals of copper are found associated with many different metals under a variety of conditions. The number of important copper-producing districts is small, and the ores mined are usually of low grade. Indeed, such low-grade ore bodies as are mined can only be worked economically on a large scale.

The following are the ore minerals of copper, the more important ones being italicized.

	Ore minerals.	Composition.	Per cent, Cu.
Unweathered zone	<i>Chalcopyrite</i>	CuFeS ₂	34.5
	<i>Chalcocite</i>	Cu ₂ S	79.8
	<i>Bornite</i>	Cu ₅ FeS ₄	55.58
	<i>Enargite</i>	Cu ₃ As ₂ S ₄	48.00
	<i>Covellite</i>	CuS	66.5
	<i>Tetrahedrite</i>	Cu ₈ Sb ₂ S ₇	52.10
	<i>Tennantite</i>	Cu ₈ As ₂ S ₇	57.00
	<i>Native copper</i>	Cu	100.00
Weathered zone	<i>Azurite</i>	2 CuCO ₃ , Cu(OH) ₂	55.10
	<i>Malachite</i>	CuCO ₃ , Cu(OH) ₂	57.27
	<i>Chrysocolla</i>	CuSiO ₃ , 2 H ₂ O	36.00
	<i>Cuprite</i>	Cu ₂ O	88.8
	<i>Melaconite</i>	CuO	79.84
	<i>Brochantite</i>	CuSO ₄ , 3 Cu(OH) ₂	62.42
	<i>Atacamite</i>	Cu(OH)Cl, Cu(OH) ₂	59.45
	<i>Chalcanthite</i>	CuSO ₄ , 5 H ₂ O	25.4

The difference in the nature of the copper compounds found in the weathered and unweathered zones is quite noticeable.

Most of the copper ores now worked are of low grade, that is as low as 2 per cent copper, but they can be profitably treated because of the extent of the operations, and the possibility of concentrating them, if the ore minerals are sulphides.

The presence of other ores often increases the complexity of the smelting process, but with modern methods the several metals are separated and saved, and impurities removed.

¹ Not uncommon as a product of weathering also, but then of little importance.

Copper-ore bodies are extensively affected by weathering. That portion of the ore body above water level may be either a limonitic gossan, from which most of the copper has been leached, or it may contain oxidized ores. As a result of the leaching, the copper may be transferred to a lower level and re-deposited by replacement of other sulphides; indeed, were it not for the process of secondary enrichment having taken place, many a copper deposit in the southwest would not be workable. In this process the copper is usually reprecipitated as chalcocite although other sulphides not infrequently result; but all occurrences of chalcocite are not secondary as was formerly supposed, so that it now no longer serves as a criterion of secondary enrichment.

Types of copper-ore bodies. — Copper ores have been formed at different periods in the geologic past, but the majority of them show an intimate association with igneous rocks. Five important types of occurrence are noted, all of which appear to have been formed by magmatic waters, no magmatic segregations being known in the United States, but the chalcopyrite-pyrrhotite deposits of Sudbury, Ontario, are possibly in part at least of this type.

Contact metamorphic deposits. — These are found in crystalline, usually garnetiferous, limestone, along igneous contacts, and are known at several points in the West, including the Clifton-Morenci and Bisbee districts of Arizona, Bingham Canyon, Utah, *etc.* These were of some importance, especially in former years, but they have been outranked by the next type which is sometimes associated with them.

Disseminated deposits. — Bodies of sulphides, deposited by magmatic waters, in igneous rocks or schists, either in connection with the preceding type or alone, form a type which has become of great importance in the West. The country rock is more or less fractured, and the low-grade disseminated ore is sometimes present in large amounts. Its commercial value is due to secondary enrichment, and over it there is a leached capping of variable thickness. Since these ores often occur in porphyritic igneous rocks, they are sometimes called *porphyry coppers*. This disseminated type is worked at Ely, Nev.; Bingham, Utah; Miami and Ray, Ariz.; Clifton-Morenci, Ariz., *etc.*

Vein deposits. — In some districts as Butte, Mont., the copper ore is found in fissure veins, in which it has been deposited either by replacement or cavity filling. The wall rock is often strongly altered by hydrothermal metamorphism. Other metals may be present in variable amounts.

A modification of this type is found in the Michigan area, where native copper occurs in amygdaloidal volcanics, sandstones, and conglomerates, either as a replacement, or filling cavities. This occurrence

is unique among those of the United States, but a similar type is found in New Jersey and farther south, and its analogue in Arctic Canada. Recent investigations by Graton and associates of the Michigan deposits indicate that the source of the copper was magmatic and not from the lava flows as formerly supposed.

Vein deposits of mixed character, in which the copper is associated with lead, zinc, gold or silver, are worked at a number of points in the Rocky Mountains. Copper veins, with or without gold, are found at several points in the southern Appalachians. The Virgilina, Virginia-North Carolina, district is typical of the former type, and the Gold Hill, N. C., of the latter.

Lenses in schists. — Lens- or pod-shaped deposits of chalcopyrite, with or without pyrite or pyrrhotite, are found in some schistose rocks. These deposits, which are usually of low grade, may represent replacements of metamorphic rocks along fissures, replaced limestone, or in some instances they are thought to be metamorphosed contact-metamorphic deposits.

They are worked at Ducktown, Tenn., where, according to Emmons, they are regarded as limestone replacements; and the same type has been found at a number of other points in the Appalachian states from Vermont to Alabama, but are usually of low grade, owing to the large amount of pyrrhotite and pyrite and a small percentage of chalcopyrite. Similar occurrences consisting of a low-grade mixture of chalcopyrite and pyrite are worked in Shasta County, Cal.

Production. — The United States is the leading copper-producing country of the world, having in 1922 an output of 964,583,894 pounds valued at \$128,289,000.

Arizona, Montana and Michigan, are the three most important copper-producing states.

Lead and Zinc Ores

These two are often found together, and in the Rocky Mountain region, especially, gold, silver, and copper may be common associates.

Ore minerals of zinc. — The important ones are:

Name.	Composition.	Per cent, Zn.
Sphalerite.....	ZnS.....	67.0
Smithsonite.....	ZnCO ₃	51.96
Calamine.....	2 ZnO, SiO ₂ , H ₂ O.....	54.20
Hydrozincite.....	ZnCO ₃ , 2 Zn(OH) ₂	60.0
Zincite.....	ZnO.....	80.3
Willemite.....	2 ZnO, SiO ₂	58.5
Franklinite.....	(FeMnZn)O, (FeMn) ₂ O ₃ ...	variable

The first of these may be either a primary or secondary enrichment ore, while the following three are found in the weathered zone. The last three are found commercially only at Franklin Furnace, N. J.

The sphalerite (known also as blende, jack, rosin jack, or black jack) is by far the most important ore of zinc. It is often associated with other sulphides, especially galena, pyrite, and marcasite, but more rarely chalcopyrite. Both smithsonite and calamine may occur in the same deposit as secondary oxidized ores; they are sometimes of crystalline form, but more often quite impure and of crusted or earthy character.

Ore minerals of lead. — These are but few as shown below:

Name.	Composition.	Per cent, Pb.
Galena.....	PbS.....	86.4
Cerussite.....	PbCO ₃	77.5
Anglesite.....	PbSO ₄	68.3
Pyromorphite.....	Pb ₃ P ₂ O ₈ + $\frac{1}{3}$ PbCl ₂	76.36

Galena is the commonest lead mineral and may be either primary or due to secondary enrichment. In complex ores it frequently carries silver. The other three minerals occur in the weathered zone, and of these cerussite is the most often found.

Weathering of lead and zinc ores. — Sphalerite weathers rapidly, and is leached out before the galena; not that the galena does not start to alter as soon, but because it becomes covered with an insoluble weathered product, which protects the sulphide. As a result of this differential leaching the zinc may all be removed from the upper part of a mixed lead and zinc ore body. The ore will consequently change from lead above to predominant zinc below. However, both lead and zinc ores may show secondary enrichment.

Classification of lead and zinc ores. — On a mineralogical basis lead and zinc ores can be divided into three groups as follows:

1. Lead and zinc ores, practically free from copper and the precious metals.
2. Lead and zinc ores, carrying more or less gold and silver as well as some iron and copper.
3. Lead-silver ores.

In the first group, lead and manganese are not uncommon impurities, and those of southwestern Missouri carry small quantities of cadmium, calcite, dolomite, and pyrite or marcasite as common gangue minerals, and barite or fluorite may also be present.

The second group is found chiefly in the Rocky Mountains, and is not only of complex character, but differs in form and origin from the eastern deposits. Quartz is the common gangue mineral, while arsenic, antimony, and iron are common impurities.

The third group is confined to the western states, and carries small amounts of zinc, gold, and iron, in addition to the main constituents, lead and silver.

Mode of occurrence of lead and zinc ores. — Lead and zinc ores may occur under several different conditions as follows:

1. As true metalliferous veins, in igneous or stratified rocks, and with or without other metals. This type is prominent in the Cordilleran region.

2. Irregular masses in metamorphic rocks, as at Franklin Furnace, N. J. These supply zinc alone.

3. As irregular masses or disseminations, formed by replacement or impregnation in limestones or quartzites. Replacement masses in



FIG. 229.— Map showing distribution of lead and zinc ores. (After Ransome, *Min. Mag.*, X.)

quartzite and limestone are found at Leadville, Col.; disseminated ores of lead in limestone, in the southeastern Missouri district, and of zinc with some lead in limestone, in southwestern Virginia and eastern Tennessee. The disseminated ores are raised in tenor by mechanical concentration.

4. Contact metamorphic deposits. The occurrence of lead and zinc in these is usually subordinate. The one at Hanover, N. M., is mainly zinc.

5. In cavities not of the fissure-vein type, as the zinc ores of southwestern Missouri, and the lead and zinc ores of Wisconsin.

6. Oxidized ores in residual clays, with workable sphalerite bodies below in limestone, as in southwestern Virginia and eastern Tennessee.

Production. — In 1921 the United States produced 398,222 short tons of lead, valued at \$35,840,000, and 198,232 short tons of zinc, valued at \$19,823,000. This was from domestic ores.

Gold and Silver Ores

Ore minerals. — Gold and silver are obtained from a variety of ores, in some of which gold predominates, in others silver, while in still a third class the two metals may be mixed with the baser metals, lead, copper, zinc, and iron. In some ores even rarer elements like arsenic, bismuth, tellurium, *etc.*, are present.

Gold is found in nature chiefly as native gold, or as telluride. In the former case it may be visible, or mixed with pyrite, chalcopyrite, sphalerite, pyrrhotite, or arsenopyrite. Native gold may occur in both primary and secondary zones, but the telluride is always primary.

Silver, if in the native form, may be visible, or locked up mechanically in other sulphides, especially galena. Aside from this both primary and secondary ore minerals are found as below:

		Name.	Composition.	Per cent, Ag.
Primary or secondary	{	Argentite	Ag ₂ S.	87 1
		Pyrargyrite, ruby silver	Ag ₂ S, Sb ₂ S ₃	59 9
		Proustite, light ruby silver	2 Ag ₂ S, As ₂ S ₃	65 5
		Stephanite, brittle silver, black silver	5 Ag ₂ S, Sb ₂ S ₃	68 5
Weathered zone	{	Cerargyrite, horn silver	AgCl.	75 3
		Bromyrite	AgBr	57 4
		Enbolite	Ag(ClBr)	64 5
		Iodyrite	AgI	46.

Tetrahedrite (*see* under copper ore minerals) may also carry silver, replacing some of the copper, and its presence in the ore is regarded as a favorable indication.

Occurrence of gold and silver ores. — Most of the gold and silver mined in the United States is obtained from fissure veins, or similar deposits of irregular shape, and in which the ores have been deposited either from solution in cavities or by replacement. Much gold and

a little silver is obtained from gravel deposits, and some contact metamorphic deposits are known. While gold has been found occurring as an original constituent of igneous rocks, this source is not to be regarded as being of commercial value.

It can be stated in general terms that the mode of occurrence of these two metals is quite variable, and although the fissure-vein type of deposit predominates, these fissures may form in any kind of rock, or along the contact between two different kinds.

The gold- and silver-bearing fissure veins include two prominent types, *viz.*: (1) Quartz veins, and (2) propylitic veins, characterized by propylitic (p. 617) alteration of the wall rock.

Quartz-vein type.—This type which is characterized by quartzose ores with free gold and auriferous sulphides extends from Lower California, along the Pacific Coast to the Canadian boundary, and is also found along the Alaskan coast. The deposits of the Mother Lode belt in California, and the Nevada City district of the same state, are of this type, as are also the gold veins near Juneau, Alas. Other gold quartz veins, although of older age, occur in the Black Hills, S. Dak., and in the southern Appalachian states, but both these occurrences are sometimes more of the nature of impregnations in quartzose schists than well-defined veins.

Propylitic veins.—These represent an important type associated with lavas of Tertiary age, the veins being sometimes entirely within the volcanic rocks. The ores are usually quartzose, and while either gold or silver may predominate, the amounts of the two metals may be the same. Other metals may be present, but not necessarily in large amounts. The well-known mining camp of Cripple Creek, Col. (where the gold and silver are combined with tellurium), and the Goldfield and Tonopah districts of Nevada, are of this type.

Auriferous gravels.—These yield a large percentage of the gold production of the United States and Alaska, having yielded about 14 million dollars' worth in 1921, but comparatively little silver. Their mode of origin has already been referred to on page 608, and they are found chiefly in those areas in which auriferous quartz veins are prominent. Hence, they are somewhat widely known in the Cordilleran region, the Black Hills, and even in the South Atlantic states. Their greatest development, however, is along the Pacific Coast from California up to Alaska.

In these gravels, the gold occurs in the form of nuggets, flakes, or even small dust-like grains. In some cases the gravels have been covered by lava flows. Where the gravels are located on hill slopes,

and are not covered by lava caps, they can be worked by hydraulic mining, but where they occur in or at the level of modern stream channels, dredging is commonly resorted to for recovering the gold.

Production. — The United States production of gold in 1922 was valued at \$49,096,000, and of silver at \$55,510,859.

References on Ore Deposits

General works. — 1. Farrell, Practical Field Geology, New York, 1912. (McGraw-Hill Book Co.) 2. Gunther, Examination of Prospects, New York, 1912. (McGraw-Hill Book Co.) 3. Kemp, Ore Deposits of United States and Canada, New York, 1906. (McGraw-Hill Book Co.) 4. Ries, Economic Geology, 6th ed., New York, 1930. (Wiley & Sons.) 4a. Lindgren, Mineral Deposits, New York, 3rd ed., 1927. (McGraw-Hill Book Co.) 4b. Parks. Textbook Mining Geology. 4c. Emmons, W. H., Principles of Economic Geology, N. Y., 1918. (McGraw-Hill Book Co.) 5. Spurr, J. E., The Ore Magmas, 2 Vols., 1923, N. Y. (McGraw-Hill Book Co.)

Special papers of importance. — 6. Emmons, S. F., Amer. Geol. Soc., Bull. XV, p. 1, 1904. (Theories of ore deposition.) 7. Emmons, S. F., Min. & Sci. Press, Sept. 22, 1906. (Forms of ore bodies.) 8. Emmons, W. H., Min. & Sci. Press, Dec. 4 and 11, 1909. (Outcrops.) 9. Emmons, W. H., U. S. Geol. Survey, Bull. 529, 1913. (Enrichment of sulphide ores.) 10. Kemp, Amer. Inst. Min. Engrs., Bull., Apr., 1913. (Groundwaters.) 11. Kemp, Econ. Geol., I, p. 207, 1906. (Problem of metalliferous veins.) 12. Kemp, Contact metamorphic deposits, in Types of Ore Deposits, 1911. 13. Irving, Econ. Geol., VI, p. 527, 1911. (Replacement deposits.) 14. Lindgren, Econ. Geol., IV, p. 409, 1909. (Metallogenetic epochs.) 15. Posepny, Amer. Inst. Min. Engrs., Trans., XXIII, p. 197, 1894. (Genesis of ore deposits.) 16. Tolman, Min. and Sci. Press, Jan. 4, 18, and 25, 1913. (Secondary sulphide enrichment.) 17. Van Hise, Amer. Inst. Min. Engrs., Trans., XXX, p. 27, 1901. (Deposition of ores.)

Areal Reports. — The Geological Surveys of New York, New Jersey, Virginia, North Carolina, Georgia, Alabama, Michigan, Arkansas, Missouri, Wisconsin, Minnesota, Oklahoma, Colorado, Washington, and California have issued a number of special reports. See also bulletins and other special reports issued by the U. S. Geological Survey and by the Canada Geological Survey.

Important papers relating to various phases of ore deposits are published in Economic Geology and the Trans. of the Amer. Inst. Min. and Met. Engrs.

CHAPTER XVIII

HISTORICAL GEOLOGY

Introduction. — There may be some question as to just how much historical geology a civil engineer has need of, even though it is of great importance to the mining engineer. In some cases a knowledge of the kinds of materials forming the earth's crust and their structural features may be sufficient, but in other instances it is important to know at least the fundamental facts of stratigraphical geology.

The rocks of the earth's crust do not form a chaotic mass, whose history can not be unraveled, or whose structural relationships as parts of past history can not be told. They show us, on the contrary, that the earth has been developing steadily; that the sedimentary rocks which underlie three-quarters of the earth's surface have been laid down, one upon the other (speaking in general terms), and that as this process of sedimentation has continued from early times to the present, there has been a corresponding development of life upon the surface of the globe. We can, therefore, make use of these entombed animal and plant remains to determine the relative ages of at least sedimentary rocks, and thereby ascertain whether the rocks in a given area occupy their normal position or not. If the latter it indicates some crustal disturbance, such as folding or faulting. Rocks of very similar appearance may be of different ages, and thus be separable only by their contained fossils.

In the preliminary examination that was made along the line of the Catskill aqueduct, the borings showed a considerable thickness of dipping sedimentary rocks of similar character. The question at once arose whether we had to deal with a repetition of beds caused by folding or faulting, or a continuous series of different ages but of similar lithologic character. The problem was solved largely by identification of the fossils in the different beds of rock. The presence of faulting at another locality was confirmed by finding older beds at one point, overlying younger ones as determined by their fossils.

Igneous and metamorphic rocks are usually non-fossiliferous, but their geologic age can often be told approximately at least by their relation to other rocks of known age.

Even though the civil engineer may not feel sufficiently familiar with historical and stratigraphical geology to work out alone some of the problems referred to above, he can recognize that they exist, and when necessary call the geologist to his aid.

FOSSILS: THEIR OCCURRENCE, PRESERVATION, AND USES

A fossil is the remains or traces of an animal or plant preserved in the rocks, whether they be consolidated or not. Some geologists restrict the term fossil to include such evidences of life to the close of the Pleistocene (p. 651) only, the post-Pleistocene (p. 651) remains being spoken of as recent and not fossil. Fossils are found in the rocks in all degrees of perfection, from fragmentary impressions, trails, burrows, etc., to perfectly preserved shells, bones, and wood.

Not all organisms after death leave traces in the rocks of their former existence, for the conditions of preservation are much more favorable for some organisms than for others. Indeed only a very small proportion of the total life of any period of geologic time is preserved in the fossil state. Among the chief conditions for the preservation of organisms in the fossil state are (1) rapid entombment in some protective material, for if left exposed after death the organisms quickly disintegrate through decay or the attacks of living animals; and (2) hard parts must usually be present in the organism, such as the shell of an oyster, the bone of a reptile, or the woody fiber of a tree; for investigation reveals the fact that vastly the majority of animals that are fossilized were those having hard shells, bones, teeth, and scales; and of plants those having a sufficient amount of woody tissue. The hard parts of such organisms as contain them resist decay after death and are therefore much more likely to be preserved in the fossil state.

Many animals, like the jelly-fish, some mollusks, most worms, etc., which lack hard parts, are less frequently preserved in the fossil state. There are exceptions, however, and the softer parts of some animals may sometimes be preserved by freezing, etc., such as in the bog ice (tundras) of northern Siberia, or a record may be left of them in the form of trails and burrows.

The habitat or conditions under which organisms lived condition largely their chance for preservation as fossils. In general the conditions on land are less favorable for the preservation of organic forms than those on the sea floors, and marine organisms are more common as fossils than those of fresh-water bodies, because chiefly of the greater abundance of marine sedimentation. Wind-formed deposits of sand and volcanic ash, flood-plain deposits of rivers, and small lakes afford

favorable conditions at times and in places for the preservation of terrestrial organisms in the fossil state. Also land forms of life at times have been carried out to sea and there entombed and preserved.

How fossils are preserved.— Fossils are preserved in rocks in various ways, dependent chiefly on the character of the organism and the manner in which entombment and preservation have been produced. The following will cover most cases: (1) In rare cases the original substance of the organism has been partly or wholly preserved, as shown in the carcasses of mammoths in the frozen gravels of northern Siberia. (2) Removal of the original substance with retention of form, which may be shown as *molds* and *casts* (see Fig. 230), both of which are common in

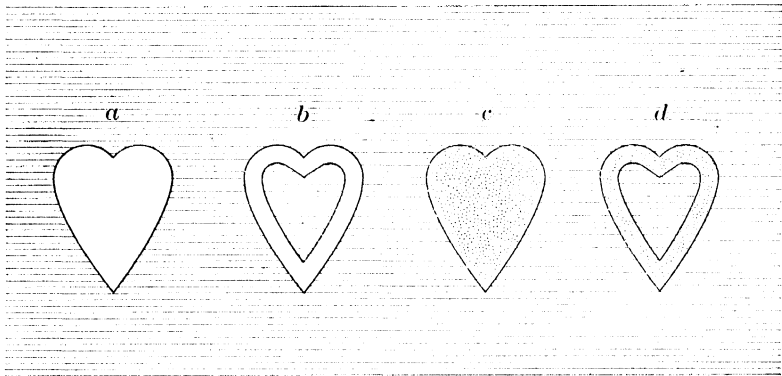

FIG. 230. — Diagram illustrating molds and casts. The lined area represents sediment. (a) External mold after removal of shell by percolating waters; (b) internal mold with original cavity filled with sediment; (c) and (d) represent the removal of the shell and the cavity subsequently filled with foreign material, (c) **cast**, (d) pseudomorph.

rocks that permit of the ready percolation of water, such as some limestones and sandstones. (3) Substitution of the original substance by mineral matter with partial or complete preservation of form, as in petrifications and pseudomorphs.¹ Silica, calcium carbonate, and iron sulphide (pyrite or marcasite) are the commonest forms of mineral matter replacing the original substance of the organism.

Kind of rocks in which fossils may be found.— Of the two primary divisions of rocks (igneous and sedimentary) fossils are usually found only in the sedimentary ones, but in these fossils are not always present

¹ A pseudomorph results from the replacement of one mineral by another, so that the form of the first is preserved by the second. Thus, limonite is sometimes a pseudomorph after pyrite.

Because of lack of uniform distribution of organisms over the sea bottom and of unfavorable physical conditions existing at the time of sedimentation. Field observations have shown that some kinds of sedimentary rocks are more likely to contain fossils than others, for instance, the fine sediments like limestones, shales, and clays are more often fossiliferous than the coarse sandstones and conglomerates. Metamorphic rocks derived from original sedimentary ones may contain fossils when the original sediments were fossiliferous and the metamorphism has not been so extreme as to destroy all trace of the organic remains. Fossils may also be found in the finer volcanic ejecta which forms ash beds and tuffs.

Geologic uses of fossils. — Fossils are primarily of fundamental importance to the geologist because of the aid which they give in re-



FIG. 231.— Diagram showing relations between Archeozoic, Proterozoic, and Cambrian. (After Chamberlin and Salisbury, College Geology.)

constructing the history of the earth. The principal uses which they serve in this direction may be summarized as follows: (1) In determining geological chronology, so that rocks may be classified and arranged in orderly sequence according to relative age; (2) evidence of geographical changes, such as the former distribution of land and water, the former distribution of plants and animals, etc.; and (3) evidence of changes in climate.

(1) *Geologic chronology.* — For any given locality the relative ages of a conformable succession of stratified rocks are based on the law of superposition, in which the oldest stratum is at the bottom and the youngest at the top. In areas of great disturbance where the normal sequence is interrupted and inversion of beds may result from folding or faulting, such inversion may be determined from other evidence. For purposes of comparing beds in widely separated areas and affecting their correlation the law of superposition though helpful can not *per se* be safely applied, for from the nature of sedimentary processes the beds are

subject to change in composition, and a limestone in one locality may pass into a sandstone or shale in another. Hence neither superposition nor lithologic character is a safe criterion for purposes of correlation, unless the bed in question can be traced continuously from one region to another. The correlation of beds in different regions must be based, therefore, on the contained fossils, for however widely separated, beds which contain similar fossils are equivalent in age and belong to the same division of geologic time.

(2) *Geographic changes.* — Much can be learned from careful study of the composition and structure of sedimentary rocks as to the geographic conditions existing at the time of their deposition, whether on land or in the sea, and if on the land the prevailing climatic conditions under which they were laid down, whether arid or not. Further information may be gained from study of the fossils as to the former distribution of land and water, especially the former extension of water over areas which are now land; as to the former presence of land barriers; and as to the character of water bodies in which the sediments were deposited, whether fresh or salt, deep or shallow, open or closed basins, etc.

(3) *Climatic changes.* — The various changes of climate in former geological periods are satisfactorily indicated by fossils, whether in any region the climate was tropical, temperate, or arctic. Thus, we find fossil plants in the rocks of Greenland similar to those that grow in the temperate latitudes, which indicate that the climate of Greenland during the growth of these plants was much milder than at present. Similarly the existence of the remains of arctic animals over parts of the United States indicates a much colder climate at one time than now. Such use of fossils, however, should be made with great caution.

DIVISIONS OF GEOLOGIC TIME

The major subdivisions of geologic time are based on organic progress — changes in animal and plant life — while the minor subdivisions are based chiefly on more detailed differences in the organisms. The divisions and subdivisions of geologic time are not yet absolutely fixed, and the minor subdivisions of one part of a continent may not agree entirely with those of another part. This is due in large measure to the fact that continuous deposition of sediment might be in progress in one area, while in another, during the same time, the area was a land surface above sea level and there was no sedimentation. In some cases sedimentation over parts of the earth's surface has been continuous and

without break, resulting in vast thicknesses of sedimentary rocks amounting in places to many thousands of feet.

The names applied to the divisions of geologic time and to those of the rocks are not the same, but for each division of the time scale there is a corresponding one of the rock scale. Thus:

Time Scale	Rock Scale
Era	Group
Period	System
Epoch	Series
Age	Stage

Thus we speak of the Silurian Period of time, but the rocks of that period are referred to as belonging to the Silurian System.

GENERAL TABLE OF GEOLOGIC TIME DIVISIONS

Cenozoic	{	Quaternary	{	Recent.		
				Pleistocene.		
		Tertiary	{	Pliocene.		
				Miocene.		
				Oligocene.		
				Eocene.		
Mesozoic	{	Cretaceous	{	Upper (Cretaceous proper).		
				Lower (Comanchean).		
		Jurassic				
		Triassic.				
Paleozoic	{	Permian.				
		Carboniferous	{	Pennsylvanian (upper).		
				Mississippian (lower).		
				Devonian	{	Neodevonian (upper).
						Mesodevonian (middle).
						Palcodevonian (lower).
				Silurian	{	Cayugan (upper).
						Niagaran (middle).
						Medinan (lower).
				Ordovician	{	Cincinnatian (upper).
				Mohawkian (middle).		
				Canadian (lower).		
		Cambrian	{	St. Croixan (Potsdam) (upper).		
				Acadian (middle).		
				Waucoban (Georgian) (lower).		
Proterozoic (Algonkian)	{	Keweenawan.				
		Upper Huronian.				
		Middle Huronian.				
		Lower Huronian.				
Archeozoic (Archean)	{	Laurentian.				
		Keewatin.				

We give on the preceding page a list of the major divisions of geologic time and their more important subdivisions, arranged in order of formation, the youngest being at the top.

ARCHEOZOIC AND PROTEROZOIC ERAS¹

The Pre-Cambrian Systems

Introduction. — The pre-Cambrian includes all rocks below the base of the Cambrian, which has been defined by Walcott as the *Olenellus*² beds or their equivalent. They are the oldest, thickest, and most widespread rocks of which we have knowledge, and even where not exposed at the surface they probably form the basement on which the younger rocks rest. In North America these rocks have been estimated to occupy an area of more than 2,000,000 square miles.

In most areas where studied in North America the pre-Cambrian rocks are separated from the overlying *Olenellus* beds (Cambrian) by an unconformity (p. 657, Figs. 231 and 232); but in some areas they appear to be conformable with the overlying rocks. In the latter areas it is difficult to distinguish between the pre-Cambrian and the succeeding Cambrian rocks because the distinguishing features of these ancient rocks differ greatly among themselves. For such areas, essentially the only distinction that can be made between the pre-Cambrian and the Paleozoic is the sparseness of fossils in the pre-Cambrian; their greater crystallinity and metamorphism as a whole, greater abundance of igneous rocks, and of schists and gneisses of doubtful origin.

Subdivisions. — Following the usage of the United States Geological Survey, the pre-Cambrian rocks can be divided into two systems as follows:³

Algonkian	{	One or more series in various geological provinces, separated by unconformities. To these series local names are applicable.
	}	
		Unconformity.
Archean	{	Keewatin. (Igneous unconformity.) Laurentian.
	}	

Under this division of the pre-Cambrian, the Algonkian includes most of the pre-Cambrian sedimentary rocks, while the Archean, the base-

¹ These are included by some under the single name *Eozoic*. For Archeozoic the word Archean (meaning very old) is preferred by some geologists; and for Proterozoic, Algonkian, as defined by the U. S. Geol. Survey, is used as a synonym in this book. Archeozoic is referred to by some as "Age of Larval Life," and Proterozoic as the "Age of Primitive Invertebrates."

² A genus of trilobite (see Fig. 235).

³ See Bull. 360, U. S. Geol. Survey, 1909, p. 20.

ment complex on which the Algonkian rests, includes massive igneous rocks and their derived schists and gneisses, as well as other large masses of schists and gneisses of unknown origin, and smaller masses of highly metamorphosed fragmental formations. Pre-Cambrian rocks are known in many countries, but they have very widespread distribution in North America. The greatest area of these rocks in North America is the "Canadian Shield," which includes the greater part of the northern half of the continent and the outlying areas of Newfoundland, eastern Canada, the Adirondacks, and the smaller areas of Wisconsin, Minnesota, and Michigan. In the United States similar rocks extend along the Atlantic slope from New England to Alabama. In the western half of the continent pre-Cambrian rocks form a part of the Cordilleran ranges in southern British Columbia and the United States. Isolated small areas occur in South Dakota, Missouri, Oklahoma, and Texas.

Metamorphism and structure. — A characteristic feature of the pre-Cambrian rocks in general, whether igneous or sedimentary, is the usually highly metamorphosed character which they exhibit over large areas. Foliation (cleavage) is one of the most conspicuous structural features of most of these rocks, probably developed chiefly under conditions of regional metamorphism and igneous intrusion. However, certain of the banded and gneissic structures may have been developed before final cooling of the masses. Some of the igneous rocks are massive in structure and not foliated.

In many of the surface lavas ellipsoidal structure is developed and is thought to indicate the extrusion of the lavas in most cases under submarine rather than land conditions. The pre-Cambrian rocks have, on the whole, suffered intense but unequal deformation, indicated by folding, faulting, jointing, and irregular fracturing. The amount of deformation and metamorphism the rocks have suffered, especially those of the Algonkian, shows striking differences, and may be less than for rocks of later (Paleozoic) age in other regions.

Economic products. — The crystalline rocks of pre-Cambrian age contain important deposits of a variety of metallic ores, the characteristic metals of which are iron, copper, nickel, gold, and silver. Here belong the iron ores (hematite chiefly) of the Lake Superior region, which yields more iron ore than any area of similar size in the world, the three iron-bearing formations being of Keewatin, middle and upper Huronian age. The magnetite deposits of New York and other eastern states, and the important native copper deposits of Michigan, the most extensive ones known, are also of pre-Cambrian age. The rich ores of silver and cobalt, at Cobalt, Ontario, and of nickel at Sudbury, occur in

rocks of this age. A part at least of the gold deposits of the southern Appalachian states and of portions of the Cordilleran region including New Mexico, Wyoming, and South Dakota, are to be placed as pre-Cambrian.

Life during the pre-Cambrian. — No fossils have been found in the rocks belonging to the Archean system, but the presence of carbonaceous (graphite) rocks and limestones¹ is thought to imply the existence of life during the Archean. A few definitely determined fossils have been found in sedimentary rocks of the Algonkian system in Montana and the Grand Canyon region of Arizona, which are the oldest definite fossils yet found. Besides these definite fossils, the existence of life in Algonkian time as in the Archean is inferred from the presence of carbonaceous rocks and limestones. The most abundant fossils of the Proterozoic limestones are the secretions of *calcareous algae* commonly known as *Cryptozoön* (Schuchert).

The Archean System

The Archean is composed of a crystalline complex unconformably below and older than the Algonkian sedimentary rocks (see Subdivisions, p. 652). This complex is made up of acid and basic volcanic and plutonic igneous rocks (p. 46), schists, and gneisses partly derived from these and partly of unknown origin, and small masses of metamorphosed sediments. The common kinds of igneous rocks are granites (p. 74), gneisses and schists (pp. 127, 132), and altered basalts (p. 87) and gabbros (p. 80); of sedimentary rocks are slate, graywacke, conglomerate, tuffs, marble, and iron formation.

The Archean rocks are greatly altered by metamorphism, their characteristic structure being cleavage or schistosity, which is usually much folded and contorted.

The Archean system is divisible into the Keewatin and Laurentian. The Keewatin is the older division of the Archean and consists largely of greenstones and green schists (p. 133) derived from original surface volcanic rocks of intermediate and basic character; while the Laurentian consists of granites, gneisses, and schists of acid character. It becomes apparent then that the prevailing rocks of the Archean are igneous with only very subordinate sediments, indicating that for this period of geologic time igneous processes were the dominant ones. No trace of organic remains has yet been found in any of the Archean rocks. The Keewatin is one of the three commercially important iron-bearing horizons in the Lake Superior region.

¹ The hypothesis advanced by Walcott that bacteria probably were an important factor in the deposition of the Algonkian limestones has received strong support by his discovery of bacteria resembling *Micrococci* in the fossil alga of the Newland limestone. *Science*, N. S., vol. XLI, No. 1067, June 11, 1915, p. 870.

The Algonkian System

The Algonkian includes the sedimentary formations and their metamorphosed equivalents with associated igneous rocks which lie beneath the Cambrian and rest on the Archean complex (Fig. 231). It includes most of the pre-Cambrian sedimentary rocks. In the Lake Superior region the Algonkian system is well developed and has been studied in great detail. It is divided into four groups which are separated by well-marked unconformities from each other and from the Cambrian above and the Archean below (Fig. 231):

	Cambrian.	
	(Unconformity.)	
Algonkian.	1. Keweenawan.	}
	(Unconformity.)	
	2. Upper Huronian.	
	(Unconformity.)	
	3. Middle Huronian.	
	(Unconformity.)	
	4. Lower Huronian.	
	(Unconformity.)	
	Archean.	

The lower, middle, and upper Huronian have much in common, since they are composed chiefly of sedimentary rocks, although locally the igneous ones may be more abundant. Each division includes the common kinds of elastic rocks (p. 99) or their metamorphic equivalents together with limestone, and chemically deposited iron formations. The Keweenawan which lies unconformably on the upper Huronian (Fig. 231) comprises a great thickness of lava flows and sediments, and unlike the Huronian, the former are more abundant than the latter. Sedimentary beds increase upward and lava beds fail altogether in the upper part of the Keweenawan.

The Algonkian rocks have suffered severe metamorphism as expressed usually in folding, faulting, and cleavage or schistosity. A few authentic fossils are reported from the Algonkian sediments of Montana and the Grand Canyon region of Arizona which represent the earliest forms of life yet found. The existence of limestone and carbonaceous (graphitic) material are considered additional evidence of life in the Algonkian.

PALEOZOIC ERA

The Paleozoic era meaning *ancient life*, may be subdivided into (1) *Early Paleozoic*, including the Cambrian, Ordovician, and Silurian periods, known as the *Age of Invertebrates*; (2) the *Middle Paleozoic*, including the Devonian and Mississippian periods, called the *Age of Fishes*; and (3) the *Late Paleozoic*, including the Pennsylvanian and Permian periods, called the *Age of Amphibians and Ancient Floras*.

The Cambrian System

The name *Cambrian* is derived from Cambria, the ancient name of Wales, and was first proposed by Sedgwick in 1835 for a group of fossiliferous rocks in north Wales since shown to be Silurian and Ordovician. As now used the name Cambrian is confined to the oldest system of Paleozoic rocks known to contain fossils.

Subdivisions. — The Cambrian system is divided into three groups, with characteristic faunas. The North American divisions are:

Cambrian . .	{	1. Upper — Croixan (Wis.) (Potsdam) — <i>Dikellocephalus</i> beds.
		2. Middle — Acadian — <i>Paradoxides</i> beds.
		3. Lower — Waucoban (Calif.); Taconian (Appalachic geosyncline) — <i>Olenellus</i> beds.

The names Georgian,¹ Acadian, and Potsdam² refer to names of localities where the three divisions of the Cambrian system were first differentiated in North America.

Distribution. — Cambrian rocks are found on all the continents, but in North America they have a greater extent and thickness than in any other known part of the world. The known maximum thickness of Cambrian rocks in North America does not exceed 12,000 feet. The outcrops of Cambrian rocks are usually observed in narrow belts about the pre-Cambrian areas, and where the relations of the two systems are known the Cambrian rocks are usually found resting unconformably on the older ones.

The principal areas of Cambrian rocks known from exposures at the surface are distributed as follows: (1) Occupying pre-Cambrian depressions from the Adirondacks to Newfoundland, including parts of New England and western Canada; (2) flanking the Appalachian uplift from New York to Alabama; (3) in the Lake Superior region including parts of Michigan, Wisconsin, and Minnesota; (4) in Missouri and Texas; (5) in the Rocky Mountains from Canada to British Columbia; and (6) in the Great Interior Basin including Nevada and Utah. Cambrian rocks are also exposed in the Grand Canyon of the Colorado. It seems probable that Cambrian rocks were widely deposited over the continent of North America, but for the most part they are buried under later sediments.

Rocks. — From our knowledge of the character of the rocks composing the Cambrian areas in North America, we may infer that unlike

¹ Walcott proposed the name *Waucoban* in 1912 for Lower Cambrian from Waucoba Springs, California. For its equivalent in the east Schuchert uses Taconian.

² For the Upper Cambrian the name *Croixan* from the St. Croix River, Wisconsin, has been proposed. For the late Upper Cambrian, Ulrich proposed Ozarkian.

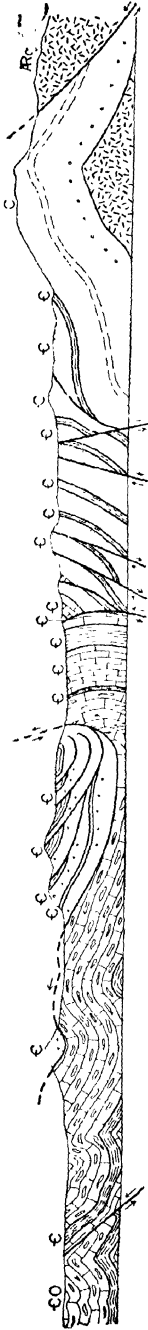

FIG. 232.—Section showing relations of the Archean and Cambrian south of Johnson City, Tenn. Arc = Archean; C = Cambrian; Cc = Cambro-Ordovician. Length of section about 14 miles. (Keith, Roan Mountain folio 151, U. S. Geol. Survey.)

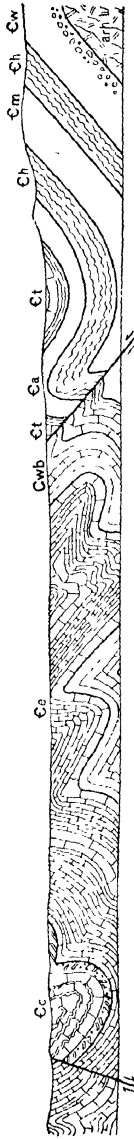

FIG. 233.—Section showing relations of the Cambrian in the vicinity of Chambersburg, Penna. Cw, Ch, Cm, Ca, and Ct (Georgian), Cw and Cc (Acadian), Cc (Saratoga) = Cambrian. Length of section about 6 miles. (Stose, Mercersburg-Chambersburg folio 170, U. S. Geol. Survey.)

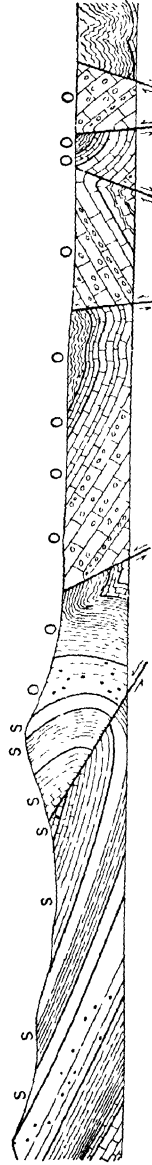

FIG. 234.—Section showing relations of the Ordovician and Silurian in the vicinity of Mercersburg, Penna. O = Ordovician; S = Silurian. Length of section about 6 miles. (Mercersburg-Chambersburg folio 170, U. S. Geol. Survey.)

pre-Cambrian time it was one of dominant sedimentary processes.

Cambrian includes all the common kinds of sedimentary rocks, such as conglomerates, sandstones, shales, and limestones (chiefly dolomitic). The structure of the beds, such as cross bedding, ripple marks, etc., indicates that the rocks were deposited for the most part in shallow water, and the life is characteristic of marine conditions.

Clastic rocks (p. 99) probably predominate in the Lower Cambrian, while limestones (chiefly dolomitic) are important in most areas of the upper and middle Cambrian, except in the northern interior of the United States where sandstone prevails in the upper division. Where limestone characterizes the upper Cambrian, such as in the southern Appalachians, it can not usually be sharply distinguished from the overlying Ordovician.

In many places over the interior of the continent the strata are still nearly horizontal, but in some areas, especially in the Appalachians, they have been folded, faulted, and more or less metamorphosed (Figs. 232 and 233). In places the sandstones have been changed into quartzites, the shales into slates, and the limestones into marbles.

Igneous activity was continued into Cambrian time as shown by the occurrence of igneous rocks (chiefly basic) occurring in Newfoundland, New England, Virginia, and Tennessee in the east, and in British Columbia in the west. Similar rocks are found in the Cambrian of England, France, and Belgium.

Economic products. — The Cambrian rocks contain some metallic ores, but they have nowhere proved to be very productive. In the eastern part of the continent some iron deposits and probably gold belong to this period, but little metallization occurred in the western half. Probably the most important products obtained from the Cambrian in the United States are roofing slates and marble (Chapter XI). These come from the eastern half of the continent, but not all of the eastern slates and marbles are of Cambrian age. To this system belong the roofing slates of the Llanberis Beds in North Wales.

Life of the Cambrian. — *Plants.* — Except some doubtful markings regarded as seaweeds, no remains of plants have been found in the Cambrian rocks.

Animals. — The rocks of the Cambrian system furnish us the first adequate record of animal life. There are known from all countries combined at least 1500 species, 90 per cent of which are trilobites and brachiopods, the former being most abundant. All the leading types of invertebrate life were represented in Cambrian times, and all the known fossils were marine species, there being no traces of land animals. Trilobites were the most characteristic forms of Cambrian life, and because of their importance and abundance the three divisions of the Cambrian are named for the three dominant genera of these crustaceans (see page 656 and Fig. 235). Thus, the Lower Cambrian is characterized by the genus of trilobite *Olenellus*, the Middle

Cambrian by the genus *Paradoxides*, and the Upper Cambrian by the genus *Dikellocephalus* (see Fig. 235). Brachiopods rank next to trilobites in importance in the Cambrian and are among the most abundant fossils. Besides trilobites and brachiopods (Fig. 235), which are the most characteristic Cambrian fossils, many other types of invertebrate animal life are represented.

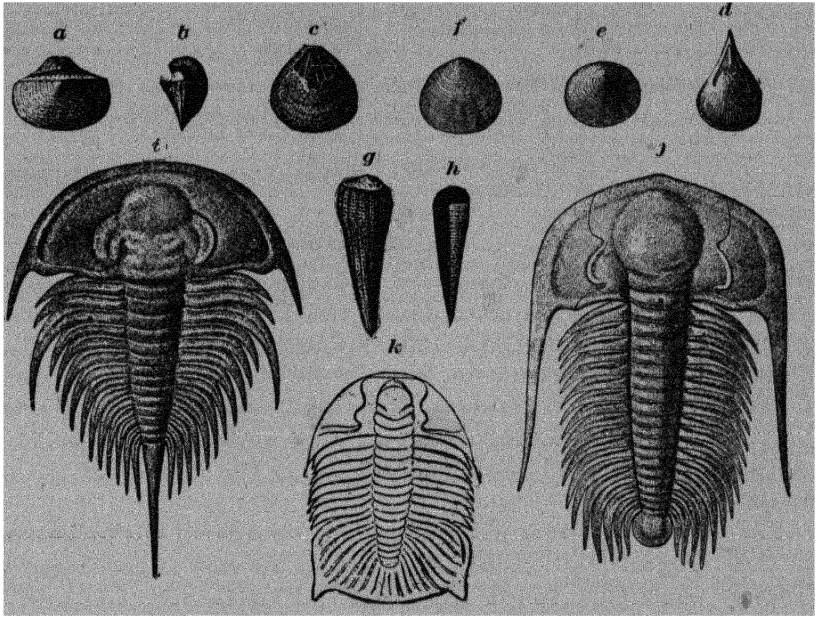

FIG. 235.—Characteristic Cambrian Fossils. Brachiopods: a, b, *Katorgia cingulata* Billings; c, d, *Lingulepis pinniformis* Owen; e, f, *Linarssonia tucconica* Walcott; Sponge-Coral: g, *Archocyathus reusschlaricus* Ford; Pteropod: h, *Hyolithes princeps* Billings; Trilobites: i, *Olenellus thompsoni* (Hall); j, *Paradoxides harlani* Green; k, *Dikellocephalus minnesotensis* Owen.

The Ordovician System

Introduction.—In North America there is general conformity between the Cambrian and Ordovician systems, except in the New York-Vermont region, indicating that the passage from one system to the other was gradual, and not marked by either mountain-making or continental uplift at the close of the Cambrian. The physical history of the Ordovician was a continuation of that of the Cambrian, and while there is evidence of minor oscillations of the land the general movement was one of subsidence. The great inland sea established over the Mississippi Valley region toward the close of the Cambrian persisted throughout Paleozoic time.

Subdivisions. — The subdivisions of the Ordovician system vary in detail for different parts of the continent, but the classification of New York State may be taken as a standard to which others are referred.

Ordovician . . .	$\left\{ \begin{array}{l} \text{Upper Ordovician} \\ \text{(Cincinnatian)} \\ \\ \text{Middle Ordovician} \\ \text{2. (Mohawkian)} \\ \text{1. (Chazyan)} \\ \\ \text{Lower Ordovician} \\ \text{(Canadian)} \end{array} \right.$	$\left\{ \begin{array}{l} \text{Richmond beds.} \\ \text{Lorraine beds.} \\ \text{Utica shales.} \end{array} \right.$
		$\left\{ \begin{array}{l} \text{Trenton limestone.} \\ \text{Black River limestone (Lowville, etc.)} \\ \text{Stones River limestone.} \end{array} \right.$
		$\left\{ \begin{array}{l} \text{Beekmantown (Calciferous) limestone.} \end{array} \right.$

General observations. — The rocks of the Ordovician system are sandstones, shales, and limestones, with a general absence of igneous rocks¹ in North America noted during this time. Limestone predominates in the Lower and Middle Ordovician and shales in the Upper Ordovician in North America, while there is a scarcity of limestone in the Ordovician of Europe. The rocks belonging to this system vary greatly in thickness, measuring thousands of feet thick in the Appalachians, but only hundreds of feet in the interior of the continent.

The Ordovician strata in the interior have suffered but little change in their original position, but elsewhere in the east (Appalachian and Taconic mountains), south (Arkansas and Oklahoma), and west the strata are folded and in places faulted (Fig. 234). The rocks have undergone more or less alteration from metamorphism since their deposition, but especially marked is the metamorphism of the Ordovician rocks of the Taconic Mountains in western New England and eastern New York.

The Ordovician was closed by converting extensive areas of shallow sea bottom into land. Crustal movements occurred, the extent and severity of which are not yet known. The great thickness of Cambrian and Ordovician rocks in the Taconic Mountains was intensely folded during this time, since the overlying Silurian rocks rest unconformably on the Upper Ordovician in this region. To the same period of time are referred the more gentle movements which resulted in the formation of the "Cincinnati Arch," a very low anticline having a general north-south direction extending through Cincinnati, and a similar one in Arkansas and Oklahoma.

Economic products. — The economic importance of the Ordovician in the United States is considerable. The principal products include gas

¹ An ash bed has recently been discovered in the Ordovician of Tennessee and Kentucky.

and oil in Ohio and Indiana (p. 581); ores of lead and zinc in the upper Mississippi Valley region, including Illinois, Wisconsin, and Iowa (p. 642), Arkansas and northeastern Missouri farther south, and southwest Virginia and east Tennessee in part; a part of the phosphate deposits of central Tennessee; and a part of the manganese ores of Virginia, Georgia, and Arkansas. Ordovician limestones are used in Portland cement manufacture, and the slates of Pennsylvania and Vermont are of value. Some of the slates of the Appalachian belt, especially in Pennsylvania and Vermont, are of Ordovician age.

Life of the Ordovician. — There was no pronounced break in the succession of life from the Cambrian to the Ordovician, but, in general, a marked advance not only in variety and abundance but of a distinctly higher order of development of forms is shown in the life of the Ordovician over that of the Cambrian.

Plants. — Seaweeds are known in the American Ordovician, and land plants are reported in the European Ordovician, but the evidence for this is claimed not to be very satisfactory.

Animals. — The Ordovician life, so far as the faunas are known, was made up almost entirely of marine invertebrates, with the important subdivisions of all the larger types represented. The most numerous and varied forms of invertebrate life were graptolites (Fig. 236), which are almost the only fossils found in some parts of the system; cystoids and crinoids (Fig. 236); cephalopods (Fig. 236) of the straight, curved, and coiled forms, the first mentioned forms predominating and being the largest and probably the most powerful of Ordovician life; brachiopods (Fig. 236), both inarticulate and articulate forms being represented, with the latter which represent a higher degree of development more abundant; and trilobites (Fig. 236), which were no larger in size than their Cambrian predecessors, were represented in this system by more than one-half of all the known genera.

By the time of the close of the Ordovician several groups of invertebrates had reached their climax and began to decline in succeeding periods. These were the graptolites among Coelenterates; the cystoids among Echinoderms; the straight shelled cephalopods (orthoceratites) among Mollusks; and the trilobites among Crustaceans. On the other hand new forms of higher development of marine invertebrates commenced their existence in the Ordovician and attained maximum importance in subsequent periods.

Fragmentary fossils of primitive vertebrates (Ostracoderms) resembling fishes have been found in the Ordovician rocks of Colorado, South Dakota, and Wyoming. Also the first evidence of land life of which we have knowledge is that of an insect wing found in the Upper Ordovician of Sweden.

The Silurian System

The name Silurian is from the ancient British tribe *Silures* which inhabited a part of Wales, and was proposed by Murchison in 1835 for the rocks now grouped as Ordovician and Silurian.

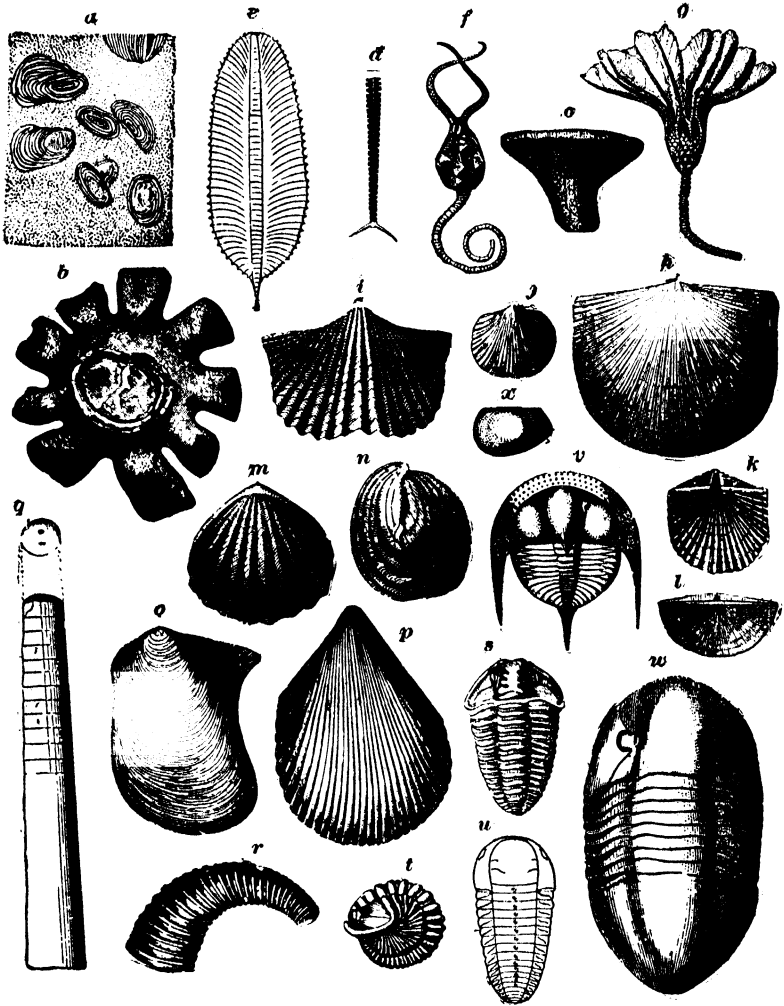

FIG. 236. — Some characteristic Ordovician fossils. — Algae: *a*, *Girvanella ocellata* Seely; Sponges: *b*, *Brachospongia digitata* Beecher $\times \frac{1}{2}$; *c*, *Zittella typicalis* Ulrich $\times \frac{1}{2}$; Graptolite: *d*, *Climacograptus bicornis* Hall; *e*, *Phyllograptus typus* Hall; Cystid: *f*, *Pleurocystis filitextus* Billings $\times \frac{1}{2}$; Crinoid: *g*, *Glyptocrinus dyeri* Meek $\times \frac{1}{2}$; Brachiopods: *h*, *Rafinesquina alternata* (Rafinesque); *i*, *Platystrophia ponderosa* (lynx) Foerste; *j*, *Dalmanella testudinaria* (Dalman); *k*, *Orthis tricrenaria* Conrad; *l*, *Plectambonites sericea* (Sowerby); *m*, *n*, *Rhyuchotrema capax* (Conrad); *p*, *Byssongelia radiata* (Hall); Cephalopods: *q*, *Orthoceras junceum* Hall; *r*, *Cyrtoceras subannulatum* D'Orbigny; Trilobites: *s*, *t*, *Calymene calliocephala* Hall; *u*, *Triarthrus beckii* Green; *v*, *Trinucleus concentricus* Eaton; *w*, *Isotelus platycephalus* Hall; Ostracod: *x*, *Leperditia fabulites* (Conrad).

Subdivisions. — The New York classification of the Silurian system may be taken as the standard of reference in this country. It is subdivided as follows:

Silurian	{	Cayugan Series	{	Manlius limestone.
		(Upper Silurian)	{	Cobleskill limestone.
	{	Niagaran Series	{	Salina beds.
		(Middle Silurian)	{	Lockport — Guelph limestone.
	{	Medinan Series	{	Clinton — Rochester shale.
		(Alexandrian)	{	Medina sandstone.
{	(Lower Silurian)	{	Oneida conglomerate.	

Distribution. — As traced by their exposures at the surface the Silurian rocks have their principal distribution in the eastern half of the continent. In the United States the principal areas include (1) the Appalachian region, extending from New England to Alabama; and (2) the interior or Mississippi Valley region, extending from New York westward beyond the Mississippi into Iowa, etc., and southward into Missouri and Arkansas, and probably into Oklahoma and western Texas. While rocks of this age are known in Alaska, California, Nevada, and Utah, it seems probable that most of the western part of the United States was land during the Silurian, having emerged from the sea at the close of the Ordovician. Areas of Silurian rocks are known in eastern Canada, including Newfoundland, in the Hudson Bay region, and farther north.

General observations. — The Silurian system includes all the common kinds of sedimentary rocks, such as conglomerate, sandstone, shale, and limestone, and in addition rock salt and gypsum in places. Igneous rocks of Silurian age have been definitely determined in very few localities in North America, but some of those of New Brunswick, Nova Scotia, and Maine are thought to be of this period. Clastic sediments predominate in the Appalachian region, where the Silurian strata attain their greatest thickness (5000 feet), while limestone largely prevails in the interior, and the total thickness of strata is much less than farther east.

It is inferred from the nature of the sedimentary rocks that they represent on the whole shallow water deposits, laid down over areas that were gradually subsiding, with gentle oscillations recorded in places. In the Appalachian region the Silurian strata have been folded and in places faulted (Fig. 237), and in New England and the maritime provinces of eastern Canada the strata are separated from those of the Ordovician below by an unconformity which resulted from the Taconic disturbance. The beds of the interior region have on the whole suffered

Subdivisions. — The New York classification of the Silurian system may be taken as the standard of reference in this country. It is subdivided as follows:

Silurian	{	Cayugan Series	Manlius limestone.
		(Upper Silurian)	Cobleskill limestone.
	{	Niagaran Series	Salina beds.
		(Middle Silurian)	Lockport — Guelph limestone.
	{	Medinan Series	Clinton — Rochester shale.
		(Alexandrian)	Medina sandstone.
}	(Lower Silurian)	Oneida conglomerate.	

Distribution. — As traced by their exposures at the surface the Silurian rocks have their principal distribution in the eastern half of the continent. In the United States the principal areas include (1) the Appalachian region, extending from New England to Alabama; and (2) the interior or Mississippi Valley region, extending from New York westward beyond the Mississippi into Iowa, etc., and southward into Missouri and Arkansas, and probably into Oklahoma and western Texas. While rocks of this age are known in Alaska, California, Nevada, and Utah, it seems probable that most of the western part of the United States was land during the Silurian, having emerged from the sea at the close of the Ordovician. Areas of Silurian rocks are known in eastern Canada, including Newfoundland, in the Hudson Bay region, and farther north.

General observations. — The Silurian system includes all the common kinds of sedimentary rocks, such as conglomerate, sandstone, shale, and limestone, and in addition rock salt and gypsum in places. Igneous rocks of Silurian age have been definitely determined in very few localities in North America, but some of those of New Brunswick, Nova Scotia, and Maine are thought to be of this period. Clastic sediments predominate in the Appalachian region, where the Silurian strata attain their greatest thickness (5000 feet), while limestone largely prevails in the interior, and the total thickness of strata is much less than farther east.

It is inferred from the nature of the sedimentary rocks that they represent on the whole shallow water deposits, laid down over areas that were gradually subsiding, with gentle oscillations recorded in places. In the Appalachian region the Silurian strata have been folded and in places faulted (Fig. 237), and in New England and the maritime provinces of eastern Canada the strata are separated from those of the Ordovician below by an unconformity which resulted from the Taconic disturbance. The beds of the interior region have on the whole suffered

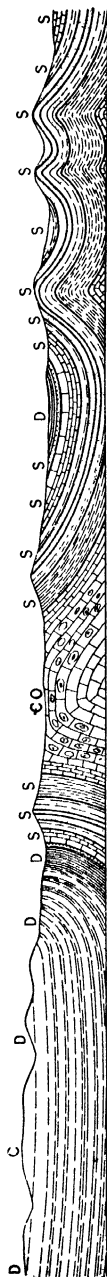

FIG. 237. — Section showing the relations of the Silurian and Devonian in the vicinity of Monterey, Virginia. **C.O.** = Cambro-Ordovician; **S** = Silurian; **D** = Devonian; **C** (Mississippian) = Carboniferous. Length of section about 14 miles. (Darton, Monterey folio 61, U. S. Geol. Survey.)

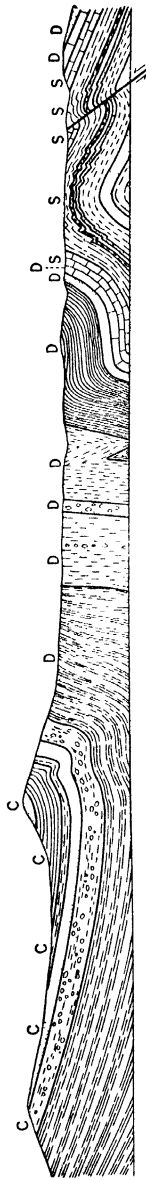

FIG. 238. — Section showing relations of the Carboniferous, Devonian, and Silurian in Berkeley County, West Virginia. **C**, Mississippian (Poccono group) = Carboniferous; **D** = Devonian; **S** = Silurian. Length of section about 6½ miles. (Stose and Swartz, Pawpaw-Hancock folio 179, U. S. Geol. Survey.)

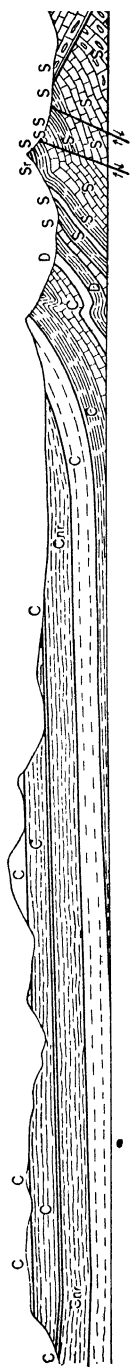

FIG. 239. — Section showing relations of the Carboniferous in the Virginia-Tennessee region. **S** = Silurian; **D** = Devonian; **C** = Carboniferous. Length of section about 14 miles. (Campbell, Estillville folio 12, U. S. Geol. Survey.)

only slight disturbance, usually observing a nearly horizontal position, and the interval between the two systems can be made out only on fossil evidence.

The extensive salt and gypsum deposits of the Silurian, especially in New York and Ohio, indicate that these were deposited near the close of

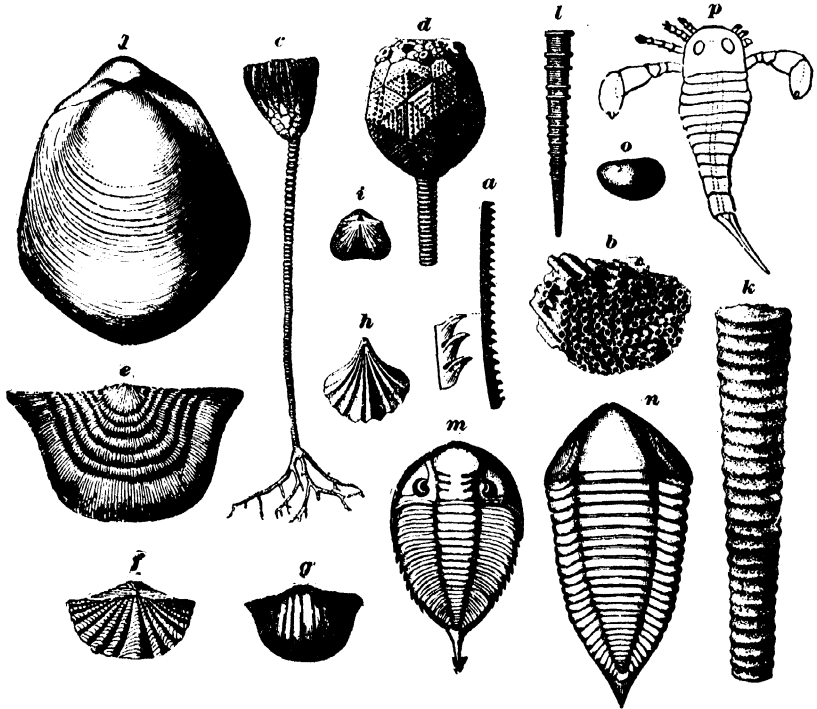

FIG. 240.—Some characteristic Silurian Fossils. Graptolite: *a*, *Monograptus clintonensis* (Hall); Coral: *b*, *Halysites catenulatus* Linnaeus; Crinoid: *c*, *Eucalyptocrinus crassus* Hall $\times \frac{1}{4}$; Cystid: *d*, *Caryocrinus ornatus* Say; Brachiopods: *e*, *Leptaena rhomboidalis* (Wilkins); *f*, *Spirifer sulcatus* Hisinger; *g*, *Plectambonites transversalis* Wahlenberg; *h*, *Rhynchotrete americana* Hall; *i*, *Bilobites biloba* (Linnaeus); *j*, *Pentamerus oblongus* Sowerby; Cephalopod: *k*, *Dawsonoceras americanum* Foord; Pteropod: *l*, *Tentaculites gyraeanthus* Hall; Trilobites: *m*, *Dalmanites limularis* Hall; *n*, *Homolomotus delphinoccephalus* Green; Ostracod: *o*, *Leperditia alta* Conrad; Eurypterid: *p*, *Eurypterus remipes* Meek (Reduced).

the period in great lagoons or inclosed seas that were cut off from the interior sea, with occasional access for obtaining new supplies of salt water. The precipitation indicates that these substances were concentrated by evaporation under the conditions of an arid climate.

The history of the Silurian period involves (1) a general submergence of the eastern part of the United States west of Appalachia, by which the sea became more and more widespread until the close of the Niagaran epoch; (2) a partial withdrawal of the sea from the same area in the Salina epoch; and (3) an extension of the sea at the close of that epoch.

The Silurian climate was in general warm, and moist, but wide areas were arid for a part of upper Silurian time (Cayugan).

Economic products. — The Silurian rocks in the eastern half of the United States contain a variety of minerals of commercial importance. Among the important ones are the fossil or oölitic iron ore (hematite) of the Clinton formation extending from New York to Alabama, and extensively mined in the Birmingham district, and on a smaller scale in several of the states to the north (p. 633); considerable oil and some gas from the Clinton sandstones of central Ohio and eastern Kentucky (see Chapter XV); gypsum in New York and Ohio (p. 526); and salt in New York, Ohio, and Michigan; and in addition to these sandstone, limestone, and slate for constructional purposes (Chapter XI). Sandstones are quarried in several states and crushed for use in glass making.

Life of the Silurian -- In many respects Silurian life is a continuation of the Ordovician life, except that it was less varied. There was not only expansion of forms but advance in organic development indicated for most classes of organisms. Families and classes remained essentially the same, but most of the genera and species were new. Some groups which attained their climax in the Ordovician diminished in the Silurian, while others expanded, and still others made their appearance for the first time.

Plants. — Our knowledge of Silurian plant life is meager, and hardly more definite than in the Ordovician. Land plants have been reported from some localities.

Animals. — Corals, erinoids, and brachiopods were abundant in the Silurian seas (Fig. 240). Graptolites greatly diminished, but corals gained and are one of the important features in Silurian life. Among echinoderms cystoids are abundant, blastoids are rare, while echinoids are more common than before (Fig. 240). Among mollusks, cephalopods are still masters of the sea (Fig. 240). Among the crustacea trilobites, while numerous and represented partly by new genera and species, are less abundant and important, while eurypterids (Fig. 240) have increased in numbers and size, and *scorpions* appear for the first time both in America and in Europe. Brachiopods are still very abundant, but are represented largely by new genera and species (Fig. 240). Some fresh water fishes also appear.

The Devonian System

The name Devonian was first applied by Murchison and Sedgwick in 1839 for a great series of rocks in the counties of Devon and Cornwall, England. In North America the passage from Silurian to Devonian was a gradual one for most areas; indeed the change was so gradual that geologists are not entirely agreed as to where the dividing line between the two systems should be drawn. The change was a quiet one and

not accompanied by mountain-making movements or continental uplift.

Subdivisions. — In New York the Devonian system is subdivided as follows:

Devonian	Upper Devonian	{	Chautauquan Series	Chemung and Catskill.	
		{	Senecan Series	{ Portage beds. Genesee shale. Tully limestone.	
		{	Erian series	{ Hamilton shale. Marcellus shale.	
	Middle Devonian	{	Ulsterian series	{ Onondaga limestone. Schoharie grit. Esopus grit.	
		{	Oriskanian series	Oriskany sandstone.	
	Lower Devonian	{	Helderbergian series	Kingston beds.	
				Becraft limestone.	
					New Scotland beds.
					Coeymans limestone.

Some of the names in the last two columns are not yet applicable to Devonian formations in other parts of the continent.

Distribution. — The distribution of Devonian rocks in North America as revealed in surface exposures includes the following principal areas: (1) The Appalachian region, extending from New York to Alabama, inclusive; (2) the northeastern region, including parts of Maine, Gaspé province, Quebec, New Brunswick, and Nova Scotia; (3) the Great Lakes and Mississippi Valley region, including parts of New York, Ohio, Indiana, Illinois, Michigan, Tennessee, and Kentucky east of the Mississippi, and parts of Minnesota, Iowa, Missouri, Oklahoma, and Texas west of the Mississippi; and (4) the western region, including small areas in the Rocky Mountains, fairly widespread development between the Rocky Mountains and the Sierras, in the Canadian Rockies, and farther west in California, Oregon, and Alaska. Devonian rocks, so far as known, are largely absent from the Great Plains region, which probably indicates that this territory was land during this time.

General observations. — In most of the areas, the Devonian rocks in North America consist almost entirely of sediments with all the common kinds represented. Igneous rocks of this age have scant development on the American continent, being, so far as known, limited to New Brunswick, southern Quebec, Nova Scotia, and Maine, in the northeast, and to some of the western areas, especially the Klamath Mountains, which contain tuffs and flows of this age. In western Europe, especially over parts of Great Britain, Germany, and France,

intense volcanic activity is manifested in vast masses of lavas and their associated pyroclastics (p. 56).

The Devonian formations attained their greatest thickness along the Appalachian region, comprising chiefly shales and sandstones. So far as known the rocks are mostly of marine origin, but the red beds of later Devonian in Pennsylvania and adjacent states, and in Acadia, are believed by some to be of fresh-water origin. In the British Isles, and in western and northwestern Europe, both marine and lacustrine deposits of Devonian age occur. Throughout the Mississippi Valley the Devonian sediments are thin and mostly calcareous in composition, while those of the western or Cordilleran region are somewhat thicker, they are chiefly calcareous.

Over the American continent the Devonian was a period of comparative quiet, except to the northeast in Maine, New Brunswick, southern Quebec, and Nova Scotia, where the strata were upturned and folded by mountain-making movements, accompanied by volcanic activity on a large scale. In some of the western areas, as in the Klamath Mountains, the rocks of this system are also greatly disturbed. Similar disturbance of the Devonian beds occurred in Great Britain and central Europe. Elsewhere, so far as discovered, the Devonian and Mississippian strata are conformable both on this continent and in Europe. Figure 237 shows the relations of the Devonian and Silurian in the Appalachians in middle western Virginia, and Fig. 238 shows the relations of the Devonian, Silurian, and Carboniferous (Mississippian) in West Virginia.

Economic products. — The Upper Devonian is the chief source of oil and gas in western Pennsylvania, southwestern New York, and a part of West Virginia, and Ohio. In Ontario the Middle Devonian is the oil-bearing series. Besides oil and gas valuable phosphate deposits occur and are worked in the Devonian shales of central Tennessee.

Life of the Devonian. — The life of the Devonian progressed along several important lines, but the general character of its marine invertebrate fauna is similar to that of the Silurian. Some groups of animals declined, others were greatly expanded, and still others appeared for the first time.

Plants. — During Devonian times the land was clothed with a rich and luxuriant plant life, including all the higher classes of cryptogams or non-flowering plants, and the lowest kinds of flowering plants (gymnosperms). The principal flora was composed of ferns, club-mosses (lycophods), and horsetails (equiseta).

Animals. — Among marine invertebrates the sponges, corals, echinoderms, brachiopods, and mollusks were very abundant in Devonian times (Fig. 241). Sponges are among the conspicuous forms in this system; graptolites are almost extinct, while corals are greatly increased both in number and in size (Fig. 241); crinoids and blastoids are increased in number and variety (Fig. 241); brachiopods are abundant

but they culminate in this system after which they decline (Fig. 237); and cephalopods are abundant with important differences noted in development over the Silurian forms. (See Fig. 237.)

Trilobites continue to decline but are not entirely rare (Fig. 237), while eurypterids

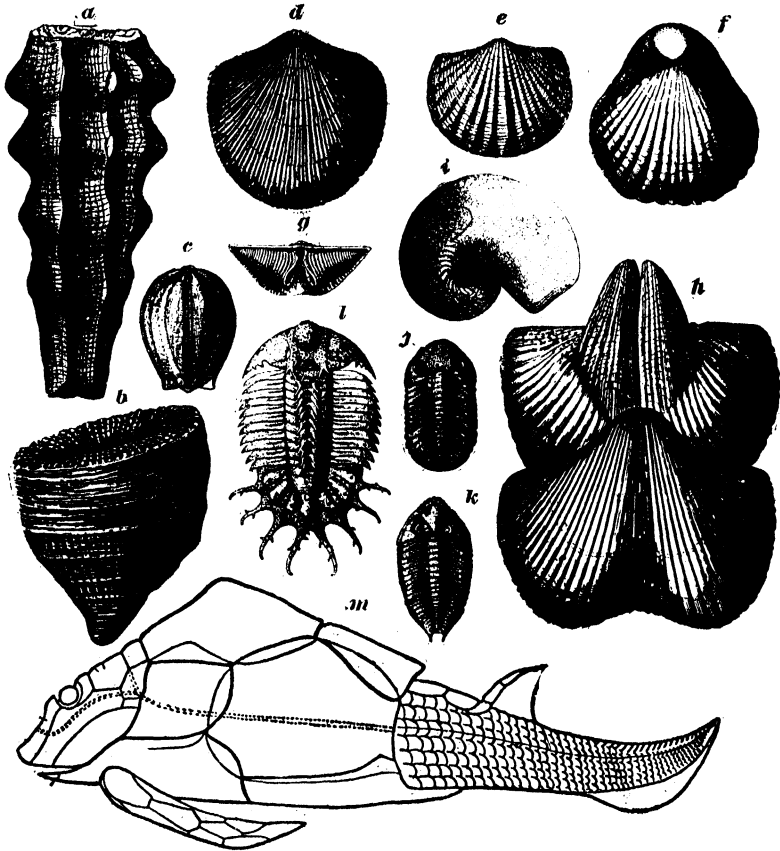

FIG. 241.—Some Characteristic Devonian Fossils. Sponge: *a*, *Hydnoceras tuberosum* Conrad; Coral: *b*, *Helliophyllum halli* Edwards and Haine; Blastoid: *c*, *Nucleocrinus verneuli* Troost; Brachiopods: *d*, *Atrypa reticularis* Linnaeus; *e*, *Tropidoleptus carinatus* (Conrad); *f*, *Gypidula galeata* (Dalman); *g*, *Spirifer mucronatus* (Conrad); *h*, *Spirifer arenosus* (Conrad); Cephalopod: *i*, *Manticoceras oxy* Clarke; Trilobites: *j*, *Phacops rana* Green; *k*, *Odontocephalus selenurus* Eaton; *l*, *Tetraspis grandis* Hall; Fish: *m*, *Pterichthys testudinarius*.

reach their culmination in size, some of them measuring six feet in length. Insects, which appeared in the Silurian, were abundant but are still rare as fossils.

It is among the marine vertebrates, especially the fishes, that Devonian life shows greatest progress. Indeed the Devonian is frequently called the Age of Fishes. The

Devonian fishes, represented by a rich and varied fauna, differed greatly from the true modern fishes (the *teleosts*) by not having a complete internal bony skeleton but were mail-clad forms with the head and much of the body covered with heavy bony plates (Fig. 241). Footprints of amphibians, air-breathing vertebrates, are reported from the Upper Devonian of Pennsylvania.

The Carboniferous System¹

The Carboniferous system was so named because of the vast coal deposits which it contains; indeed the name came into use in the early part of the last century when it was believed that no coal deposits existed in any other formation. This conception, of course, has since proved to be erroneous, for coal has been formed in all the major periods of geologic time since the Carboniferous. However, it is still true that the principal coal deposits of the globe belong to this system.

Subdivisions. — The Carboniferous rocks exhibit different aspects in different parts of the continent, so that no standard scale of reference can apply to the continent as a whole. A different scale has been made therefore for the eastern, Mississippi Valley, and Rocky Mountains regions, although the principal subdivision into the Lower or Mississippian and Upper or Pennsylvanian is generally applicable for this and other continents. The subjoined table gives the succession in Pennsylvania, which is the scale of reference for the eastern region, and the Mississippi Valley.

PENNSYLVANIA		MISSISSIPPI VALLEY	
Upper Carboniferous	{	Monongahela Conemaugh Allegheny Pottsville	}
		Pennsylvanian	{
			Coal measures Millstone grit
Lower Carboniferous	{	Mauch Chunk ((Greenbrier)) Pocono	}
		Mississippian	{
			Kaskaskia St. Louis Warsaw Osage { Keokuk Burlington Kinderhook

Distribution. — The principal Carboniferous areas on the continent are: (1) The northeast Atlantic border region, which includes the Nova Scotia and New Brunswick area, and a smaller one in Rhode Island; (2) the Appalachian region, extending from the southern border of New York southwestward to Alabama, and covering parts of Pennsylvania, Ohio, Maryland, Virginia, West Virginia, eastern Kentucky, Tennessee, Georgia, and Alabama; (3) the Interior or Mississippi Valley region, which includes (a) parts of Indiana, Illinois, and western Kentucky, forming the Eastern Interior, (b) a part of Michigan forming the North-

¹ In America three systems are now accepted, namely, Mississippian, Pennsylvanian, and Permian.

ern Interior, (c) parts of Iowa, Missouri, Nebraska, Kansas, Oklahoma, and Arkansas, forming the Western Interior, and (d) a part of Texas forming the Southwestern; and (4) the Western region, which comprises extensive areas extending from and including the Great Plains westward to the Pacific coast, and northward into Alaska and Canada. In the Arctic regions of America the Carboniferous rocks are believed to be rather widespread.

General observations. — The Mississippian period (Subcarboniferous or Lower Carboniferous) was one of widespread submergence of the North American continent and was closed by widespread emergence, while the next period, Pennsylvanian (Coal Measures or Upper Carboniferous), was one of gentle oscillation, first above and then below sea level, for the region between the Appalachian Mountains and the 100th meridian. Submergence was somewhat general over the western part of the continent during this time.

Because of the widespread emergence toward the close of Mississippian time (Tennessean of Ulrich) resulting from orogenic movements, followed by an interval of erosion, the Pennsylvanian rocks rest unconformably on the Mississippian over wide areas, but in some localities, notably in Arkansas, the strata of the two periods appear to be transitional. Figures 238 (West Virginia), 239 (Virginia-Tennessee), and 242 (Alabama) show the structural relations of the Carboniferous in the Appalachians region, and Fig. 243 shows the relations in Colorado. (See also Fig. 247, Wyoming.)

The Carboniferous rocks are dominantly sedimentary, including all the common types with beds of coal. Clastic sediments (p. 99) were predominant in some regions, while limestones prevailed in others. The rocks vary greatly in thickness in different sections of the continent, but as in the preceding periods they attained great thickness in the Appalachian region. Igneous rocks belonging to this system, especially the early Carboniferous, are abundant from Alaska to California.

Economic products. — Commercially considered, the Carboniferous is one of the most important, if not the most important, of the systems because of the enormous deposits of valuable coal which it contains over the globe. (See Chapter XIV.) The coals of Carboniferous age occur east of the 100th meridian and include the best bituminous (soft) and anthracite (hard) coals on the continent. These coals belong to the Pennsylvanian period (Upper Carboniferous or the Coal Measures). The Mississippian period was characterized by general submergence with only thin beds of coal developed, chiefly in parts of the Appalachian region. Besides coal, iron ore, chiefly carbonate, known as black band

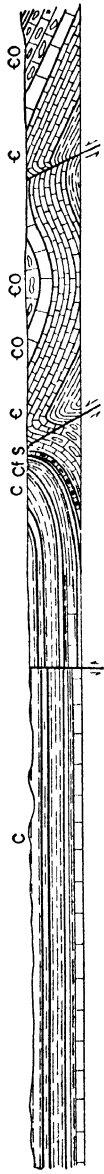

FIG. 242. — Section showing relations of the Carboniferous and Cambro-Ordovician in the vicinity of Birmingham, Ala. *C* (Pennsylvanian), *Cf* (Mississippian) = Carboniferous; *S* (Clinton) = Silurian; *Co* = Cambro-Ordovician; *Co* = Cambrian. Length of section about 12½ miles. (Butts, Birmingham folio 175, U. S. Geol. Survey.)

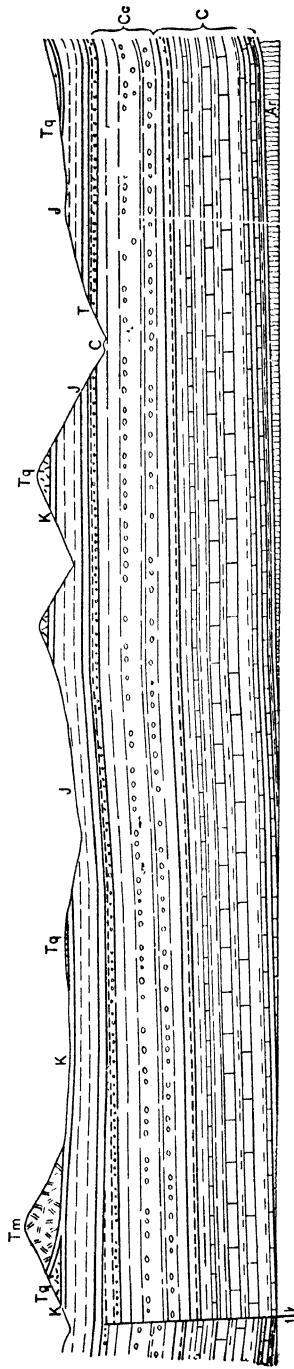

FIG. 243. — Section showing the relations of the Carboniferous, Permian (?), Jurassic, and Cretaceous in San Juan County, Colo. *Ar* = Archean; *C* (Pennsylvanian) = Carboniferous; *Ct* = Carboniferous; *K* = Jurassic; *J* = Permian (?); *T* = Triassic; *J* = Jurassic; *K* = Cretaceous; *Tm*, *Tq* = Tertiary igneous rocks. Section about 7 miles long. (Cross and Hole, Engineer Mountain folio 171, U. S. Geol. Survey.)

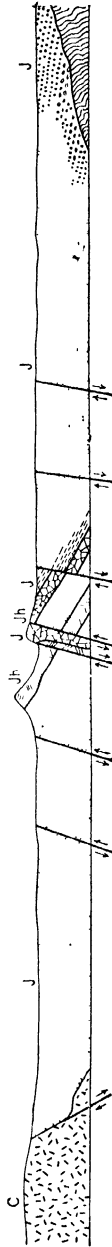

FIG. 244. — Section showing the Juratrias in the vicinity of Holyoke, Mass. *J* (sandstone), *Jh* (diabase sheets and dikes) = Juratrias; *C* = Carboniferous. Length of section about 13½ miles. (Emerson, Holyoke folio 50, U. S. Geol. Survey.) (672)

ore, is found in many Carboniferous shales. Bedded iron carbonate deposits of Carboniferous age are found in Western Pennsylvania, northern West Virginia, eastern Ohio, and northeastern Kentucky. In some places in Pennsylvania, West Virginia, Ohio, Oklahoma, Kansas, Texas, and Illinois, the Carboniferous rocks yield oil and gas.

Life of the Carboniferous. — All Carboniferous life is entirely Paleozoic in aspect, yet there were some marked advances over that of the Devonian system. Land life, both plants and animals, was abundant and varied, and aquatic life was represented by both fresh water and marine forms. The Carboniferous is referred to as the *Age of Amphibians and Lycopods*, as the Devonian is the *Age of Fishes*.

Plants. — Plant life was very abundant in Carboniferous times and the conditions were unusually favorable for growth and preservation. Great swamps and estuarine marshes in which plants grew and died, and were later buried and preserved (see Chapter XIV), were widely distributed. The vegetation including both very large tree-like and smaller forms, consisted largely of cryptogams or non-flowering plants, although the lower class of flowering plants (gymnosperms) were represented. The angiosperms, the dominant flowering plants at present, had not appeared. The important plants of the Carboniferous were: (1) *Equisetæ* or horse-tail family; (2) *Sphenophylls*, now extinct; (3) *Lycopods* or club-mosses; (4) fern-like plants; (5) *Cordaites* or gymnosperms; and (6) ferns. (See Fig. 241.)

Animals. — Among the invertebrates crinoids are very plentiful; brachiopods have greatly diminished but are still common; and the bivalve mollusks are somewhat more abundant than in previous periods. Trilobites have rapidly declined and completely passed away with the close of the period. Eurypterids are not common, and the first known of the true spiders occur here. Insects have become exceedingly abundant, but so far as known the higher flower-loving insects are not represented, since the flowering plants had not yet begun.

It is among the vertebrates that the most marked advance in Carboniferous life is shown. The fishes were of the Devonian types but more numerous and varied, except that the ostracoderms (p. 647) have become extinct. Amphibians, the class to which the frog and salamander belong, attain much importance in the Carboniferous. They were provided with lungs for breathing air and with limbs for locomotion on land. True reptiles, some of highly specialized form, are known in later Pennsylvanian time.

Summary of General Characteristics

In general the Carboniferous was characterized by (1) low elevation above sea level of large continental areas, with frequent oscillations first above and then below sea level; (2) large portions of the continent were covered with extensive fresh water marshes which supported a luxuriant vegetation; and (3) great increase in animal life, such as scorpions, spiders, insects, etc., on the land, and amphibians in the marshes.

The Permian System

The name Permian was first suggested by Murchison in 1841 for the great development of these beds in the province of Perm in Russia. By some geologists the Permian is still regarded as a subdivision of the Carboniferous, the Upper Barren Measures. In most of the American areas there appears to be a complete transition between the Carbonif-

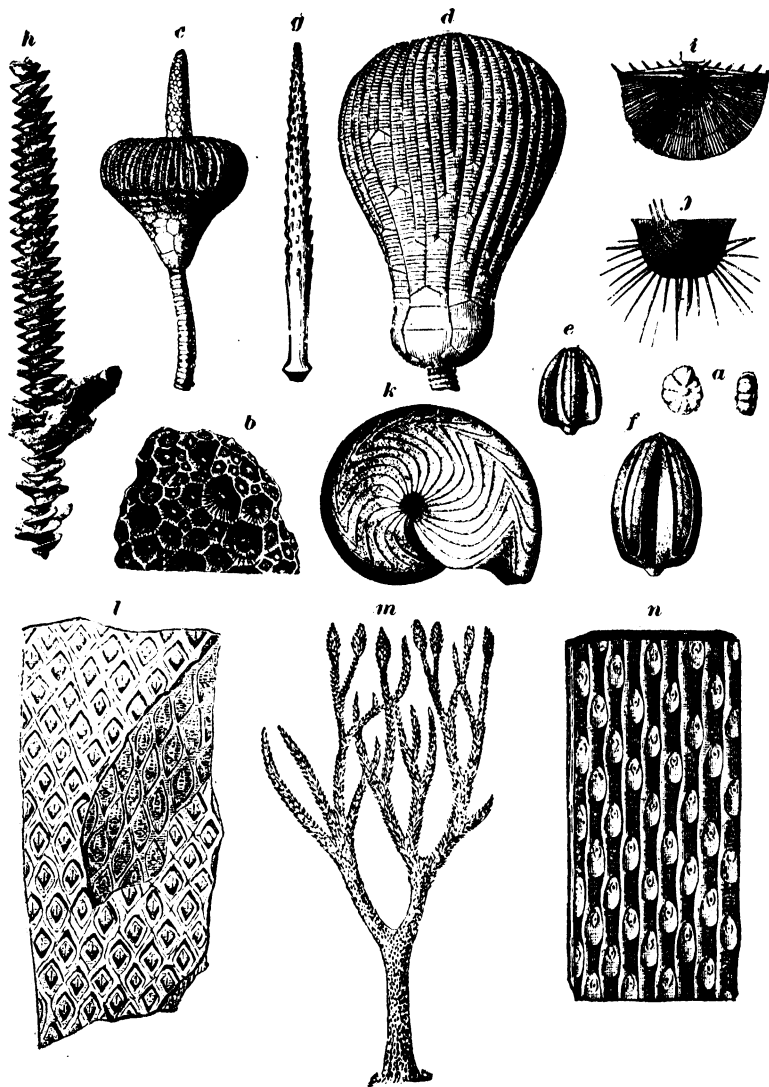

FIG. 245.—Some Characteristic Carboniferous Fossils. Protozoa: *a*, *Endothyra bayleyi* Hall ($\times 6$); Coral: *b*, *Lithostrotion canadense* Castlenau ($\times 1$); Crinoid: *c*, *Eutrochocrinus christyi* Shumard; *d*, *Woodocrinus elegans* Hall; Blastoid: *e*, *Pentremiles conoideus* Hall; *f*, *Pentremiles elongatus* Shumard; Echinoid: *g*, Spine of *Archæocidaris wortheni*; Bryozoa: *h*, *Archimedes wortheni* Hall; Brachiopods: *i*, *Chonetes illinoiensis* Konnick; *j*, *Productus magnus* Meek and Worthen; Cephalopods: *k*, *Branoceras oxus* Hall; Plants: *l*, *Lepidodendron*; *m*, Restoration of *Lepidodendron* by Dawson; *n*, *Sigillaria*.

erous proper (Coal Measures) and the beds regarded of Permian age, so that it becomes difficult to draw the line of separation. This difficulty is avoided by some geologists by calling these beds Permo-Carboniferous.

A general widespread movement of elevation over the continent resulted in converting much of the earlier eastern and central regions into dry land at the close of the Pennsylvanian period, and a greater restriction of the water-covered areas in the western region. Extensive inland bodies of water existed over parts of the land surface, and were undoubtedly connected in part with the open ocean.

Distribution. — The Permian is less well developed east of the Mississippi than west of it. In the east Permian beds are found in Prince Edward Island, Nova Scotia, and New Brunswick, and farther south in the Appalachian region over parts of Pennsylvania, Ohio, West Virginia, and Maryland. West of the Mississippi Permian beds extend from Nebraska on the north southward through Kansas, Oklahoma, and Texas; and farther west in Montana, Wyoming, Colorado (Fig. 243), New Mexico, Arizona, Utah, and Nevada.

The Permian is widely developed in other parts of the world, especially in Russia, Germany, France, and England in Europe, India, Australia, South Africa, and South America.

General observations. — The Permian followed the Carboniferous without serious break, and its beds are partly marine and partly non-marine sediments, the latter being deposited in closed basins. They consist of the commoner kinds of sedimentary rocks within places in the east of a few thin beds of coal, and west of the Mississippi, especially in Kansas and Texas, beds of gypsum and rock salt. Many of the Permian beds in Texas, Kansas, and the far west are red in color, and are known as the "Red Beds," but in many places these are only partly of Permian age. They were deposited in closed basins under conditions of aridity as indicated by the associated beds of salt and gypsum found in some of the areas.

The beds vary greatly in thickness in the different areas, attaining an estimated thickness of 1000 feet in the Appalachian region and 7000 feet in Texas. Evidences of glaciation are strongly marked in the Permian rocks over many parts of the world.

Economic products. — Rocks of Permian age in the United States contain a number of economic minerals. These include salt and gypsum in some of the states in the southwest; and in the same region ores of copper, lead, vanadium, and uranium occur in sandstones and shales of the "Red Beds" which range in age from Carboniferous to Triassic, but are partly Permian.

The rock salt and associated salines of the famous Stassfurt deposits in Prussia, and at Sperenburg south of Berlin are Permian, as are the extensive beds of rock salt which occur on the north of the Harz Mountains. In Saxony the copper-bearing shales at Mansfield have long been a source of copper.

Life of the Permian. — With the Permian ends the Paleozoic era, the most characteristic animals of which were the marine invertebrates, although vertebrates of ancient types were developed. The Permian life, both plants and animals, is transitional in character between the Paleozoic and Mesozoic, and in general character and aspect, it is indicative of the important geographic changes that were in progress, such as earth movements which resulted in vast sea areas being converted into land. When compared with the life of the Carboniferous, especially the Pennsylvanian period, that of the Permian was greatly impoverished.

Plants. — The plant life of the Permian presents marked differences from that of the Carboniferous, indicating that profound changes were in progress. On the whole, the Lower Permian flora is Paleozoic in aspect, while the Upper Permian has more of a Mesozoic cast. The great tree-like forms *Lepidodendrons* and *Sigillaria*, so abundant in the Carboniferous, are very rare; *Calamites* are reduced in importance, but ferns are very abundant and varied.

Animals. — Marine invertebrates were greatly reduced in numbers and were more restricted than in preceding times. Among vertebrates, the fishes and amphibians are represented much as in Carboniferous times, many of the same genera occur, and new ones appear. The most distinguishing character of Permian life from that of preceding periods is the large number of true reptiles.

Disturbances Closing the Paleozoic

Geographic changes in progress during the Permian and which marked the close of the Paleozoic era were greater than for any preceding time since the pre-Cambrian. At the close of the Paleozoic great mountain-making disturbances resulted in the development of (1) the Appalachian range extending from New York to Alabama, a distance of more than 1000 miles; (2) the Acadian range extending from Newfoundland to Rhode Island, a distance of more than 800 miles; and (3) the Ouachita range in Arkansas and Oklahoma. These movements resulted at the same time in converting most of the region extending eastward from the Great Plains into dry land, and of a part of that of the western interior or Great Basin.

The first period of mountain-making disturbance in North America during Paleozoic time occurred at the close of the Ordovician, and resulted in the elevation of the Taconic Mountains, the Cincinnati Arch, and a similar one in Arkansas and Oklahoma. Minor disturbances occurred in eastern Canada, New Brunswick, and Nova Scotia at the close of the Devonian.

MESOZOIC ERA

The Mesozoic era represents the *middle* or *mediæval* geological history, and has been aptly called the *Age of Reptiles*. It was probably shorter than the Paleozoic, and is divided into three¹ systems, each of which is described below.

The Triassic System

The Triassic is so named from the three-fold subdivision of its strata in Germany, where the rocks are extensively developed and were first studied in detail.

Distribution. — There are three principal general regions in North America in which Triassic strata are developed. These are: (1) The eastern or Atlantic slope (Figs. 244 and 246); (2) the western interior (Fig. 243); and (3) the Pacific coast. The strata in these three regions are unlike in many respects; those of the Atlantic slope being continental, those of the western interior being lacustrine in part, and those of the Pacific coast being marine.

General observations. — The Triassic (Newark) beds of the Atlantic slope extend as disconnected elongated areas from Nova Scotia to South Carolina. They comprise chiefly elastic rocks, — sandstones, shales, and conglomerates, — locally thin beds of limestone, and in Virginia and North Carolina beds of coal. They were deposited in long and narrow troughs roughly parallel to the present coastline. From the presence of ripple marks, sun cracks, and tracks of land animals, they were deposited under shallow water or subaërial conditions.

The prevailing color of the elastic sediments is red, although black shales and gray sandstones occur. They contain more or less feldspar and mica, important minerals in the crystalline rocks which surround them and on which they were laid down. The beds are monoclinial in attitude and are extensively broken by faults. Basic igneous rocks of diabasic character in the form of sheets and dikes are associated with the sedimentary beds (Figs. 244, Mass., and 246, N. Y.).

The western interior region is included between the 100th and 113th meridians, and extends from the southern boundary of the United States northward into Canada. The principal strata are composed of elastic sediments (red beds) containing some salt and gypsum, and the character of the materials indicates that they are all of continental origin.

¹ There is a tendency at present to divide the Mesozoic into four systems by dividing the Cretaceous into Comanchean and Cretaceous.

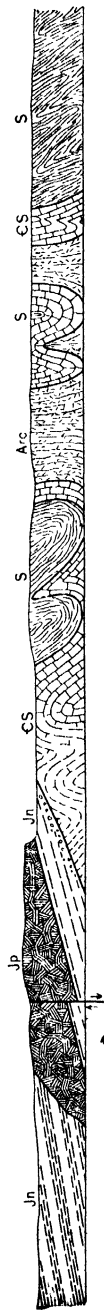

FIG. 246. — Section showing the relations of the pre-Cambrian, Silurian, and Juratrias at New York City. *Arc* = Archean; *CS* = Cambro-Silurian; *S* = Silurian; *J_n* (sandstones and shales), *J_p* (diabase) = Juratrias. Length of section about 7 miles. (Merrill, New York City folio 83, U. S. Geol. Survey.)

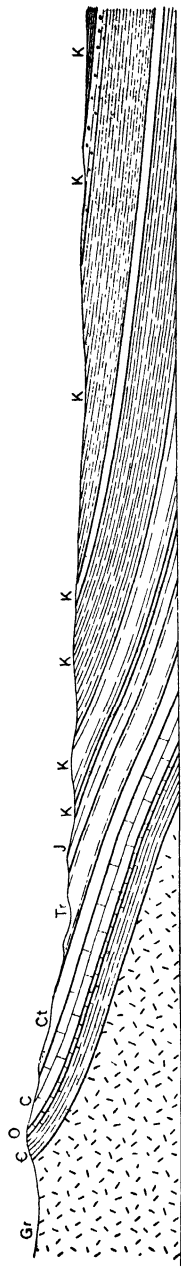

FIG. 247. — Section showing the relations of the Cretaceous in Johnson County, Wyo. *Gr* = Archean; *C* = Carboniferous; *Tr* = Triassic; *J* = Jurassic; *K* = Cretaceous. Length of section about 13 miles. (Darton, Fort McKinney folio 142, U. S. Geol. Survey.)

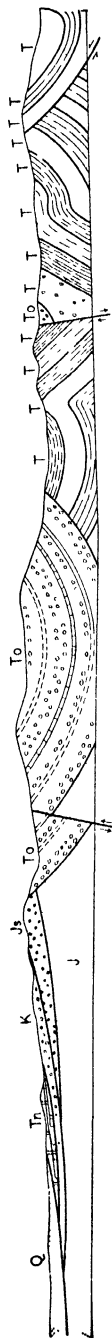

FIG. 248. — Section showing the relations of the Jurassic, Cretaceous, Tertiary, and Quaternary north of Berkeley, California. These are separated by unconformities, and the Tertiary shows folding and faulting. Tertiary tuffs and rhyolite flows occur. *J_s* (intrusive igneous rock), *J* (sedimentary beds) = Jurassic (Franciscan group); *K* = Cretaceous (Shasta); *T* (Miocene-Monterey group), *To* and *T_n* (Pliocene) = Tertiary; *Q* = Quaternary (Recent). Length of section about 7 miles. (Lawson, San Francisco folio 193, U. S. Geol. Survey.)

The Triassic rocks attain their greatest development on the Pacific slope, extending northward from California into British Columbia and Alaska, and eastward to approximately longitude 117°. The maximum thickness of the beds, 17,000 feet, is reported from the West Humboldt range in Nevada. The Triassic deposits of the west coast in the United States are usually calcareous, while those of British Columbia and Alaska comprise volcanic eruptive materials interbedded with marine sediments, slates and quartzites.

Economic products. — The principal economic deposits of the Triassic are salt and gypsum in some of the western states; red sandstone, known in the market as brownstone, quarried in the east for building purposes; and coal in the Richmond, Virginia, basin, and the Deep River coalfield in North Carolina, which is the only coal immediately adjacent to tidewater on the Atlantic slope.

Life of the Triassic. — *Plants.* — Triassic plant life was meager in comparison with that of the Carboniferous and Permian. It was composed chiefly of ferns and horsetails, cycads and conifers. It was an age of gymnosperms.

Animals. — There is scant record of marine life during Triassic times in North America except along the Pacific coast. Among land vertebrates reptiles were the dominant forms. Amphibians, so abundant in the preceding period, had diminished. Of particular interest is the appearance for the first time of the mammals, which were small and of a primitive type. (See Fig. 249.)

The Jurassic System

The name Jurassic was derived from the Jura Mountains of Switzerland, where the rocks of this age are well developed.

Distribution. — Jurassic formations in North America are confined to the western half of the continent, with no definitely known beds of this age occurring in the eastern half which was a region of dry land. In the western half of the continent Jurassic beds are distributed over (1) the western interior, extending from Wyoming (Fig. 247) through Montana, Utah, and Colorado (Fig. 243), into New Mexico and Arizona; and (2) the Pacific coast, extending from California (Fig. 248), Nevada, and Oregon, into Alaska and some of the Arctic Islands. Jurassic beds are also known in western Texas and southward in Mexico.

General observations. — The Jurassic rocks are the commoner sedimentary kinds, with locally marls and gypsum, and in some of the Pacific coast area associated altered basalts and diabase tuffs, indicating the presence of volcanic activity. The conditions under which the sedimentary materials were deposited were partly marine, partly lacustrine, and probably partly fluvial.

Economic products. — Important accumulations of copper ores were formed during Jurassic time in the western United States in connection

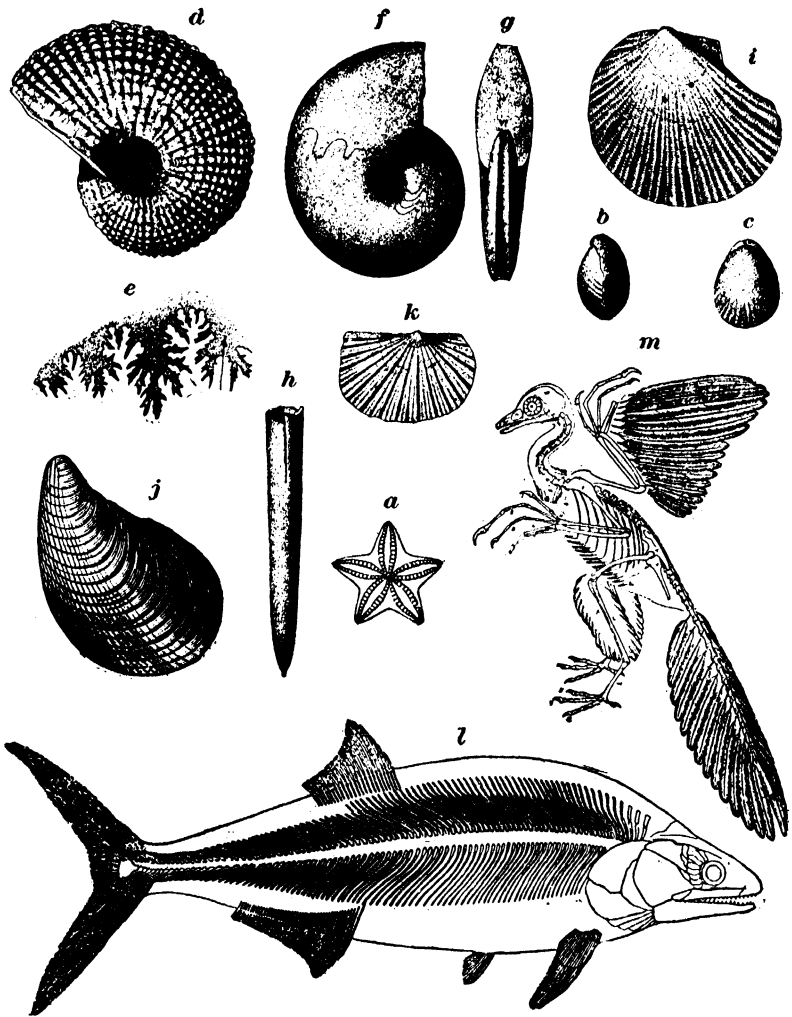

FIG. 249. — Some Characteristic Triassic and Jurassic Fossils. Crinoids: *a*, *Pentacrinus asteriscus*; Brachiopod: *b*, *c*, *Terebratula semisimplex* White; Cephalopods: *d*, *e*, *Sageucites herbichi* Mojs.; *f*, *g*, *Meekoceras gracilitatus* White; *h*, *Belemnitella americanum* Morton ($\times \frac{1}{3}$); Pelecypods: *i*, *Pseudomonotis sub-circularis* Gabb; *j*, *Aucella erringtoni* Meek; *k*, *Daonella lomnicki* Weissmann; Fish: *l*, *Hypocentrus insignis* Wagner; Bird: *m*, *Archaeopteryx lithographica* v. Meyer (Reduced).

with the basaltic extrusions from California to Alaska. Some of the copper deposits in California, British Columbia, and Alaska are referred to this age. Gypsum also occurs in places in the Jurassic formations of the western interior.

Life of the Jurassic. — *Plants.* — The plant life shows but little expansion over that of the Triassic. The leading plants were cycads, conifers, ferns, and equisetæ.

Animals. — Marine life again assumed importance in the Jurassic, although the record is less full in North America than in Europe and Asia. Reptiles were both abundant and varied, and constituted the ruling life of the period, being represented by sea, land, and air forms. No amphibians are known, fishes show advance over the Triassic forms, and mammals are still rare. Probably the most important advance in the life of this period is the first appearance of the birds. (See Fig. 249.)

Orogenic Movements

The Jurassic was closed in North America by extensive orogenic disturbances over the western half of the continent. The Sierra, Cascade, and Klamath mountains were formed, but did not reach their full growth until later. It is probable that the Coast Range of California began at this time.

The Cretaceous System

The name Cretaceous is derived from the Latin word for chalk (*Creta*) because of its early use in England for the thick masses of chalk belonging to this age. It is divided into two periods, namely, the Lower Cretaceous or Comanchean and the Upper Cretaceous or Cretaceous proper. These may be further subdivided, but because of their unlike character over different parts of the continent, the classification is not the same.

Distribution. — The principal areas of Cretaceous rocks in North America are: (1) The Atlantic border or Coastal Plain region; (2) the Gulf Coastal Plain region; (3) the Western Interior region (Figs. 243, 247, and 250); and (4) the Pacific border region (Fig. 248). In the Atlantic and Gulf border regions the Cretaceous beds are largely concealed beneath the later Tertiary

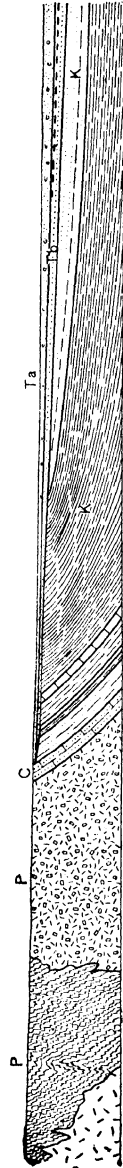

FIG. 250.—Section showing the relations of the Cretaceous and Tertiary and older systems in the vicinity of Granite Canyon, Wyo. Unconformity between the Tertiary and Cretaceous is well marked. *Ta* (Miocene), *Tb* (Oligocene) = Tertiary; *K* (Montana group) = Cretaceous; *C* (Pennsylvanian) = Carboniferous; *P* = pre-Cambrian. Length of section about 12 miles. (Darton, Laramie-Sherman folio 173, U. S. Geol. Survey.)

deposits, while in the Western Interior and Pacific border regions they form the surface rocks over extensive areas.

General observations. — As indicated above, the Cretaceous strata are extensively developed in North America. The rocks were laid down under continental, estuarine, and marine conditions. The Lower Cretaceous of the Atlantic (*Potomac series*) and the east Gulf border (*Tuscaloosa series*) regions is represented by fresh-water deposits, chiefly gravel or conglomerate, sand or sandstone, and clay; while in the western Gulf border region of Texas and Mexico the Lower Cretaceous (*Comanchean series*) is mainly marine, composed largely of limestone and chalk. The Comanchean deposits extend from Texas northward and northwestward into Kansas and Colorado, and westward to Arizona. They are also developed in the northern interior region as elastic beds of terrestrial (lacustrine and fluviatile) origin along the Front Range from Colorado to Montana as the *Morrison* beds (regarded by some as Jurassic), and northward into British Columbia as the *Kootenay* and *Cascade* formations. In the Pacific border region the Lower Cretaceous (*Shastan group*) has great development as marine elastic beds in California, and in Oregon, Queen Charlotte Islands, and northern Alaska. In places over the northern interior and Pacific border regions, the Lower Cretaceous contains some beds of coal.

The Upper Cretaceous is developed in the Atlantic and east Gulf regions as greensand, sands, clays, and chalk of marine origin; in the west Gulf region as chiefly sandstone with some lignite mostly of non-marine origin, and limestone or chalk of marine origin; in the western interior region extending northward into Canada as elastic sediments with limestone or chalk and coal, partly terrestrial (lacustrine and fluviatile) and partly as marine in origin. The four divisions recognized in this region correspond to (1) *Dakota*, (2) *Colorado*, (3) *Montana*, and (4) *Laramie*; the first and last being fresh-water formations, the others marine. In the Pacific border region the Upper Cretaceous is represented by marine deposits (*Chico series*) from California northward into Alaska.

The Cretaceous beds are generally unconformable with the underlying rocks of different ages on which they rest, and in the west the rocks were folded and faulted by mountain-making disturbances. Elsewhere the beds are roughly horizontal and show but little disturbance. The close of the period in the west was marked by great igneous activity which extended into the Tertiary and resulted in the formation of vast extrusive and intrusive rock masses.

Economic products. — The Cretaceous was the great coal-forming period of western North America, coal beds having been developed in

every one of the principal divisions, but especially in the Laramie. The coal is principally lignite, but some coking bituminous and locally even anthracite occur (see Chapter XIV). The oil of the Gulf coast region (Texas and Louisiana) and Colorado, the salt deposits of Texas, and the sulphur beds of Louisiana belong to this age.

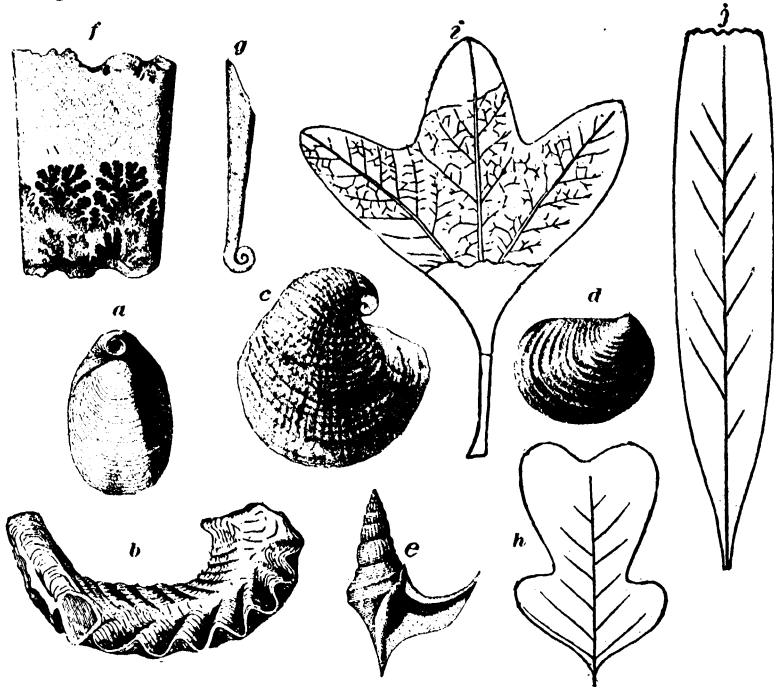

FIG. 251. — Some characteristic Cretaceous Fossils. Brachiopod: *a*, *Terabratula harlani* Whitfield; Pelecypods: *b*, *Ostrea larva* Lameroux; *c*, *Exogyra costata* Say; *d*, *Inoceramus vanuxemi* Meek and Hayden; Gastropod: *e*, *Anchura americana* Evans and Shumard; Cephalopods: *f*, *Baculites compressus* Say; *g*, Young shell of *Baculites compressus*; Plants: *h*, Tulip-*Liriodendron meeki*; *i*, Sassafras-*Sassafras cretaceum* Newberry; *j*, Willow-*Salix meeki*.

Intense mineralization followed the great intrusions of igneous rocks during Cretaceous times in the west. Gold was the principal metal formed with copper next; lead and zinc occur, with silver usually present but rarely important.

Life of the Cretaceous. — *Plants.* — Angiosperms, both monocotyledons and dicotyledons, constituted the characteristic plant life of Cretaceous times. Among the living genera of dicotyledons may be mentioned the birch, beech, oak, walnut, sycamore, willow, maple, etc. (Fig. 251); and among monocotyledons palms were plentiful towards the close of the period.

Animals. — Among animals vertebrates were the most characteristic of Cretaceous life. Reptiles were the dominant types of the land, sea, and air; turtles were

numerous and some were very large; lizards and snakes appear but were not abundant; and crocodiles developed into modern forms. Birds and mammals were somewhat more abundant than before, but still played a subordinate rôle. The fishes show the most marked change in this period among the vertebrate life, the old types gave place to new ones — the *teleost* or bony types, most of which belong to modern families.

Close of the Cretaceous

The Cretaceous was marked at its close by widespread disturbances, consisting partly in general movements and partly in orogenic movements, and igneous activity on a vast scale. In the western part of North America orogenic disturbances were general, and the Rocky Mountain system had its birth at this time, as did the Andes of South America.

CENOZOIC ERA

The Cenozoic is the era of modern life, and is divided into (1) the Tertiary, or *Age of Mammals*; and (2) the Quaternary, or *Age of Man*. These are further subdivided as follows:

Cenozoic Era	{	Quaternary	{	Recent or Human
				Pleistocene or Glacial
		Tertiary	{	Pliocene
				Miocene
				Oligocene
				Eocene
			}	Neocene
				Eocene

The Tertiary System

Distribution. — The Tertiary rocks are distributed (1) as marine and brackish-water beds along the borders of the continent, including the Atlantic, Gulf, and Pacific regions (Fig. 248); and (2) as continental (lacustrine, fluvial, and subaërial) deposits in the western half of the continent (Fig. 251), including and extending westward from the Great Plains. By the close of the Tertiary period the continent had reached essentially its present extent.

General observations. — At the close of the Cretaceous (Laramic period) there was a recession of the sea over all the continents, which in North America resulted in the emergence of the great interior region. The Eocene deposits, represented by three distinct types (marine, brackish-water, and fresh water or lacustrine) cover large areas in the United States, and follow essentially the outcrops of the Cretaceous, although their extent is not so great. The Oligocene has not been completely differentiated in North America from the Eocene, but it is represented in the Atlantic and Gulf borders by certain marine formations, and in the west by terrestrial deposits. The Miocene is typically developed in the Atlantic and Gulf border regions; as a narrow fringe

skirting the Pacific coastline; and as large accumulations of lacustrine deposits in the western interior. Pliocene marine formations have slight development in the eastern part of the continent and are confined within narrow limits on the Pacific coast, where they are chiefly elastic materials. Pliocene subaerial deposits on the other hand are widespread in the west, and about the Atlantic and Gulf coasts in the east as the *Lafayette* formation.

Many of the Tertiary formations are not indurated, but consist largely of sands, clays, and greensand and shell marls; while others are partially or entirely consolidated, such as conglomerates, sandstones, limestones, shales, and tuffs. Beds of coal (chiefly lignite) and to a less extent saliferous and gypsiferous sediments occur in places. The formations have been laid down under a variety of conditions, including those that are of marine and brackish water (bays and estuaries) origin, and those that were deposited on land (lacustrine, fluviatile, and subaerial). In many of the areas the formations are unconformable on the older underlying rocks on which they rest, and with each other. Conformable relations, however, both to the underlying rocks and to individual members of the system, are frequently observed. Marked variation in total thickness of beds of the different formations and of a single formation in the same area and in different areas is shown. In some areas the beds lie nearly horizontal and give evidence of but little or no disturbance, while in many others, especially in the west, they have been greatly disturbed both by folding and faulting.

Igneous eruptions. — In the western part of the continent igneous activity commenced at the close of the Cretaceous, culminated in the Miocene, and has continued with less intensity to the present time. Igneous materials are frequent in the sedimentary formations of the west, and vast volumes of lava were poured out onto the surface from fissures as well as from volcanoes. Nearly every state west of the Rocky Mountains contains evidence of volcanic activity during Tertiary times, the Columbia River basin with its vast lava fields and the Yellowstone National Park being two conspicuous volcanic centers.

Economic products. — Tertiary coals, partly bituminous, though mainly lignitic, are distributed over a considerable area between the 120th meridian and the Pacific coast; and in the Gulf province, lignites usually of low grade but locally some sub-bituminous coals occur. The oil of California and Alaska, and in part that of the Gulf coast; the phosphates of Florida; the salt of Louisiana; the gypsum of California; and the beds of diatomaceous earth of California, Maryland, and Virginia are of Tertiary age.

In the west two important epochs of Tertiary metallization are recognized: (1) Deposits of the early Tertiary epoch represented by gold and silver, copper, lead, and zinc as the principal metals associated with intrusive igneous rocks chiefly granodiorites and monzonites; and (2) deposits of the late Tertiary epoch in which the principal metals were gold and silver associated with the volcanic rocks andesite and rhyolite.

Life of the Tertiary. — *Plants.* — For the most part, the Tertiary plants belong to the genera living at present, but their distribution was different from that of today. Their fossil forms indicate that a warm climate prevailed over North America and Europe and extended far northward, including northern Greenland and Spitzbergen. In later Tertiary time the climate gradually grew colder.

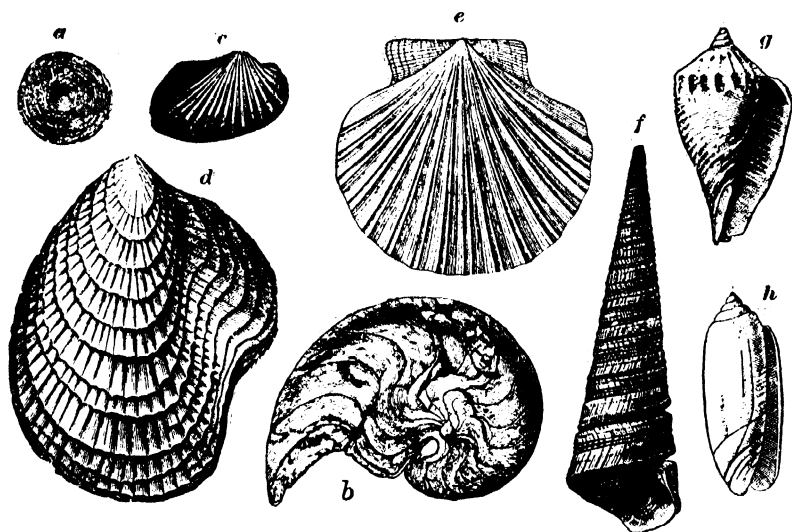

FIG. 252. — Some characteristic Tertiary Fossils. Protozoan: *a*, *Orbitoides mantelli* Conrad; Cephalopod: *b*, *Enclimaceras utrichi* (White); Pelecypods: *c*, *Arca mississippiensis* Conrad; *d*, *Ostrea sellaformis* Conrad; *e*, *Pecten madisonius* Say; Gastropods: *f*, *Turritella tampe* Heilprin; *g*, *Volutolites sayana* Conrad; *h*, *Olivia carolinensis* Conrad.

Animals. — The Tertiary invertebrate life was closely similar to that of the present time, and calls for no description here (Fig. 252). The more important points in the vertebrate life of this period were: Fishes were of modern types; amphibians were represented only by modern groups of salamanders, toads, and frogs; reptiles included numerous crocodiles and turtles; birds no longer showed reptilian characters but belonged to the modern groups; mammals attained remarkable development, and the period is appropriately called the *Age of Mammals*. The lower forms of mammals, monotremes and marsupials, were reduced to a subordinate place, and the higher placental mammals were dominant. The early primitive Tertiary forms rapidly gave way to various more specialized modern types before the close of the period.

Mountain-making Movements

The Tertiary period in North America, as well as in other continents, was characterized by great orogenic movements, which resulted in the elevation of many of the loftiest mountain ranges in the world. In North America the closing stages of the Eocene, Miocene, and Pliocene were marked by great crustal movements, especially in the west. The Coast Ranges and Sierra were further uplifted during this time, as were the north-south faulted and tilted ranges of the Great Basin, and the Mount Saint Elias range of Alaska. In the east movements of much less intensity were in progress and resulted in notable changes in geography.

In other continents the principal folding of the Alps, Carpathians, Apennines, Pyrenees, Atlas, Caucasus, and Himalayas is assigned to this period of time.

The Quaternary System

Pleistocene glaciation. — The distinguishing feature of the Pleistocene period was the extensive glaciation from thick ice sheets or continental glaciers which covered many millions of square miles of the earth's surface. The whole of northern Europe and nearly half of North America (Fig. 253) were covered by glacier ice, and the glaciation of Greenland was more extensive than at present. Ice sheets did not cover Alaska, but local glaciers were widely distributed in the western mountains of the United States south of the Cordilleran ice sheet.

It will be seen in Fig. 253 that there were three centers from which the ice moved in North America, namely, the Labradorean, the Keewatin, and the Cordilleran. Spreading from these centers, ice sheets covered some 4,000,000 square miles (Chamberlin and Salisbury).

Glacialists are now convinced that the glaciation of both North America and Europe was accomplished not by a single ice sheet, but by two or more ice advances separated by long intervals of time, or interglacial stages. At least four stages of ice invasion and as many interglacial stages are now recognized by many students of the subject in North America. The finding in places of remains of southern plants in clay beds between layers of glacial till (p. 438) indicates that the interglacial stages were caused by periods of warmer climate; indeed there is good evidence for believing that the climate of some of the intervals was certainly as mild as at present.

Evidences of glaciation. — The work (erosion and deposition) accomplished by glaciers has been described in Chapter X. There it was shown that the work of glaciers was distinctive, and the effects produced were different in different places. Because of the distinctive nature of glacial erosion and of glacial deposition the surface features

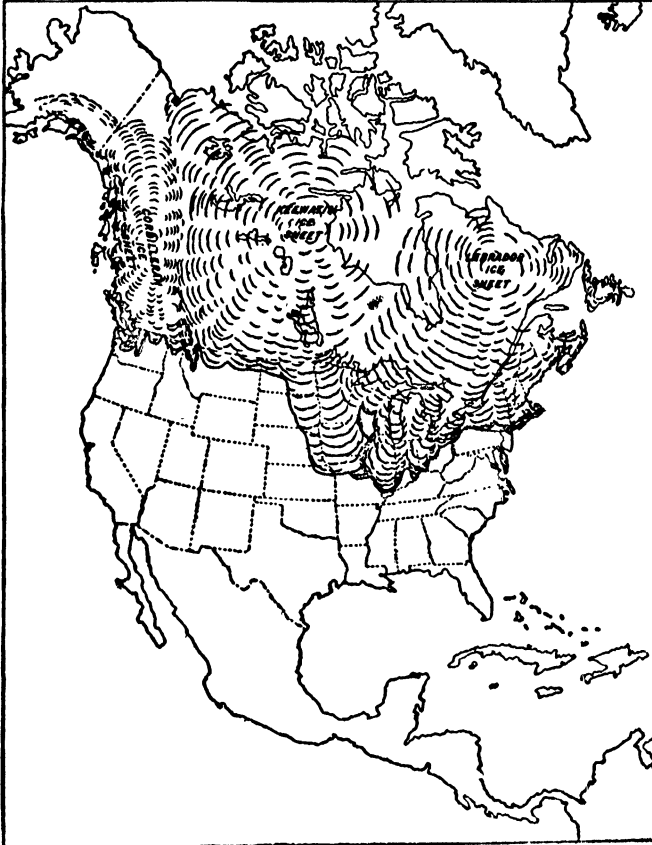

FIG. 253. — Map of North America showing the area covered by the Pleistocene ice sheet, and the three main centers of ice accumulation.

of glaciated regions are generally characteristic, and are readily distinguished from those of non-glaciated regions.

In regions of intense glaciation, the influence of glacial action on the topography has been profound. The modification of topography by glacial action has been produced (1) by erosion, and (2) by deposition; hence, the former existence of glaciers and ice sheets is shown

(a) in the modification by erosion of the surface over which they have moved, and (b) in the deposition of material of various kinds and of distinctive character.

The former presence of ice sheets in Europe and North America where no glaciers now exist is plainly indicated by a number of phenomena: (1) over wide areas there are both stratified and unstratified deposits like those now being made in association with glaciers. There are pitted plains, there are moraines, there is till, and all the kinds of deposits to be expected where glaciers have been, and many of them of a kind that no other agency than ice is now known to make. (2) Scattered through and over these deposits are rock fragments, large and small, of a totally different kind from those of the region, but known to exist in other sections, which other evidence indicates to have been the region from which the ice sheets moved. Some of these fragments are boulders of huge size, often hundreds, and even thousands, of tons in weight. No other agency than ice is competent to transport such huge masses so far from their source, which is often scores and even hundreds of miles distant. (3) The boulders and pebbles are striated, as are those carried by living glaciers; and ice is the only agency known to be capable of this result. (4) The bed rock is also grooved, striated, polished, and rounded into the roches moutonnées, just as in the case at the front of the Greenland ice sheet and the valley glaciers of the Alps, Alaska, and other mountain regions. These grooves point toward the region from which the rock fragments have been moved; and they extend with a regularity and definiteness that no other agent of erosion than glacial flow could give. (5) The roches moutonnées forms also point toward the source from which the ice came, for one side is worn more than the other. The side from which the ice came, called the *stoss* side, is smoother and worn more than the opposite or *lee* side; and from the roches moutonnées as well as from the striæ one can tell the direction of the ice motion. Thus three evidences clearly point the same way: (a) the rock fragments, (b) the striæ, (c) the roches moutonnées. (6) There are hanging valleys, U-shaped valleys, truncated spurs, and other evidences of powerful glacial erosion in places where the ice moved freely along valleys. (7) Associated with all these phenomena there has been a rejuvenation of streams, as a result of partial or complete filling of valleys that existed prior to the Glacial Period. By this rejuvenation lakes have been formed in great abundance, rivers have been forced to cut gorges, and waterfalls have been developed in great numbers. (8) Along a sinuous belt, extending from sea level

and passing across plains and over hills and even low mountains, such as the Appalachians, there is an accumulation resembling the terminal moraines of valley glaciers, and on the outer side of this, there are deposits of outwash gravels. (9) That this terminal moraine belt traces the former front of the glacier is clearly indicated by the fact that on one side of it all the phenomena mentioned above are well developed, while on the other side the phenomena are more or less completely absent. The fact that there were earlier advances, in which ice sheets reached farther than the terminal moraine of the last advance, has made this moraine a less definite line of demarcation than it would otherwise be (Tarr and Martin).

Cause of glacial period. — Many hypotheses of the cause of the glacial period have been offered, but none commands universal assent. Most of them appeal to a combination of agencies, but each centers on some one factor which gives character to the hypothesis. They fall mainly into three classes: (1) Those based on elevation of the land, the *hypsomeric hypotheses*; (2) those based on phenomena and relations outside the earth itself, the *astronomic hypotheses*; and (3) those based on changes in the constitution, movements, or cloud-content of the air, the *atmospheric hypotheses*. (Chamberlin and Salisbury.) For a discussion of these individual hypotheses see references at the end of this chapter.

Character of deposits outside the ice sheets. — Much the larger part of the earth's surface was not affected directly by glaciers during the Quaternary period. Outside the region of the continental ice sheet, the usual processes of erosion and deposition were in progress, which resulted in the formation of a variety of non-glacial deposits that are widespread but, as a rule, are not of great thickness. Naturally the conditions under which these deposits were formed were not the same for every locality; hence, variation is shown in them in accordance with the dominant agent involved in their formation. These include *aeolian* deposits (p. 47, 109) formed in arid areas and along shores; *fluvial* deposits (Chapter V) formed along streams both with and without connection with glaciers; *lacustrine* deposits (Chapter IX) of glacial and non-glacial kinds; and *marine* deposits (Chapter VIII) laid down in those areas that were submerged during Pleistocene time. Besides these principal types of deposits others occur that were formed by organic agencies on land, such as peat, marl, etc.; and those that were formed by volcanic action and by springs.

Non-glacial deposits of post-Tertiary age have widespread dis-

tribution over the United States. They are represented in the East by the *Columbia* series of the Atlantic and Gulf Coastal Plains; in the Interior by loess (p. 109), valley trains (p. 439), gravels, and numerous belts of dunes (p. 111); and in the West by all the classes of deposits enumerated above.

In the now arid basin region between the Rocky Mountains and the Sierra Nevada of the western United States, great lakes existed during the Glacial epoch. The former existence of these water bodies, Lake Bonneville, the ancestor of the present Great Salt Lake in Utah, and Lake Lahonton in western Nevada may be plainly traced by the lake cliffs and terraces along the mountain slopes, and lacustrine deposits at lower levels. Several small salty lakes are the only surviving remnants of ancient Lake Lahonton.

Changes of level. — Changes of level of the land during Quaternary time have been widespread and are still in progress in many parts of the world. Indeed there is hardly a coast which fails in evidence of either uplift as recorded in raised beaches and wave-cut cliffs, or of depression as revealed in drowned valleys, etc.

The risings and sinkings of the land are noted in regions which were not glaciated, as well as in those which were, but on the whole the movements have probably been greatest in the glaciated areas. Those areas covered by the ice sheets have risen, as a rule, since the melting of the ice, as shown by the raised beaches along the coast and by the deformation of the shore lines of the larger inland bodies of water (lakes).

Changes of level are especially well indicated in the deformed shore-lines of Lake Agassiz, an extinct glacial lake which occupied the valley of the Red River of the North, and the Great Lakes, and along the Atlantic coast. In the glaciated region of northeastern North America the evidence indicates in general greater northward elevation, while along the same coast south of the glaciated region the general movement, though complex, is one of depression, as indicated by drowned valleys and the formation of bays and estuaries.

The appearance of man. — The caves of France and other parts of Europe have furnished the earliest known human relics protected by the hard layers of calcium carbonate which incrust the cave floors. In these caves human bones and implements associated with the bones of extinct mammals, such as the cave-hyena, cave-bear, reindeer, mammoth, woolly rhinoceros, etc., have been dug from beneath the hard layers of calcium carbonate. These animals were plentiful in Europe during glacial time, and the evidence seems conclusive to

most European geologists and archeologists that man existed in central and southern Europe during the latter part of the glacial period, and possibly earlier. In America much prehistoric human material has been gathered from many localities, all of which is interpreted at present as having been buried in post-Glacial time. There is therefore no proof at present of the existence of man in America in the glacial period or earlier, neither is there proof that he was not present at that time.

List of References

1. Chamberlin and Salisbury, College Geology, Henry Holt & Co., N. Y., 1909.
2. Chamberlin and Salisbury, Introductory Geology, Henry Holt & Co., N. Y., 1914.
 - 2a. Coleman and Parks, Geology, Toronto, 1921.
3. Dana, James D., Manual of Geology, American Book Company, N. Y., 1895, 4th edition.
4. De Lapparent, A., *Traité de Géologie*, Paris, 1900, 4th edition.
5. Etheridge, Robert, Phillips Manual of Geology, Part II, Stratigraphical Geology and Paleontology, Charles Griffin & Co., London, 1885.
6. Geikie, A., Textbook of Geology, Macmillan & Co., Ltd., London, 1903.
7. Grabau, A. W., Principles of Stratigraphy, A. G. Seiler & Co., N. Y., 1913.
 - 7a. Grabau, Textbook of Geology, Part II, 1921, Heath & Co.
8. Haug, Emile, *Traité de Géologie*, Librarie Armand Colin, Paris, 1908-1911.
9. LeConte-Fairchild, Elements of Geology, D. Appleton & Co., N. Y., 5th edition, 1903.
10. Park, James, A Textbook of Geology, Charles Griffin & Co., Ltd., London, 1914.
11. Pirsson and Schuchert, A Textbook of Geology, Part II, by Schuchert, John Wiley & Sons, N. Y., 1924.
 - 11a. Quirk, T. T., Elements of Geology, Henry Holt & Co., New York, 1925.
12. Scott, W. B., An Introduction to Geology, The Macmillan Co., N. Y., 1907.
13. Shimer, H. W., An Introduction to the Study of Fossils, The Macmillan Co., N. Y., 1914.

13a. Shimer, H. W., *An Introduction to Earth History*, Ginn & Co., New York, 1925.

14. Van Hise and Leith, *Pre-Cambrian Geology of North America*, Bull. 360, U. S. Geol. Survey, 1909.

15. Willis, Bailey, *Index to the Stratigraphy of North America*, accompanied by a geologic map of North America compiled by the United States Geological Survey in coöperation with the Geological Survey of Canada and the Instituto Geologico de Mexico, U. S. Geol. Survey, Prof. Paper 71, 1912, 894 pages.

16. Wilmarth, M. G., *The Geologic Time Classification of the United States Geological Survey compared with other classifications*, U. S. Geol. Surv., Bull. 769, 1925.

APPENDIX

GEOLOGICAL SURVEYS

In the preceding pages of this book reference has been made, from time to time, to reports published by State and National Geological Surveys. Many of these, and others not mentioned, as well as geologic maps of the states and individual areas, can be obtained on application to the Director, or State Geologist. The latter can also frequently furnish engineers with information regarding local geologic details in their territory; hence, we give herewith a list of the National and State Geological Surveys, together with the name of the official in charge at the present time.

United States

United States Geological Survey, Washington, D. C.; G. O. Smith, Director.

Bureau of Mines, Washington, D. C.; Scott Turner, Director.

Alabama. — Geological Survey of Alabama; W. B. Jones, State Geologist, University.

Arizona. — Geological Survey of Arizona; G. M. Butler, Director, Arizona Bureau of Mines, Tucson.

Arkansas. — Geological Survey of Arkansas; Geo. Branner, State Geologist, Little Rock.

California. — California State Mining Bureau; W. W. Bradley, State Mineralogist, San Francisco.

Colorado. — Colorado State Geological Survey; R. D. George, State Geologist, Boulder.

Connecticut. — State Geological and Natural History Survey; W. E. Britton, Superintendent, Yale University, New Haven.

Florida. — Florida State Geological Survey; Herman Gunter, State Geologist, Tallahassee.

Georgia. — Geological Survey of Georgia; S. W. McCallie, State Geologist, Atlanta.

Idaho. — Bureau of Mines and Geology; A. W. Fahrenwald, Dept. of Geology, Moscow.

Illinois. — State Geological Survey; M. M. Leighton, Director, Urbana.

Indiana. — Department of Geology and Natural Resources; W. N. Logan, State Geologist, Indianapolis.

Iowa. — Iowa Geological Survey; G. F. Kay, State Geologist, Iowa City.

Kansas. — State Geological Survey of Kansas; Raymond C. Moore, State Geologist, University of Kansas, Lawrence.

Kentucky. — Kentucky Geological Survey; W. R. Jillson, Director, Frankfort.

Maryland. — State Geological and Economic Survey; E. B. Mathews, State Geologist, Johns Hopkins University, Baltimore.

Michigan. — Michigan Geological and Biological Survey; R. A. Smith, State Geologist, Lansing.

Minnesota. — W. H. Emmons, State Geologist, University of Minnesota, Minneapolis.

Mississippi. — Geologic, Economic, and Topographic Survey of Mississippi; E. N. Lowe, Director, Jackson.

Missouri. — Bureau of Geology and Mines; H. A. Buehler, Director, Rolla.

Montana. — F. A. Thompson, Director, State Bureau Mines and Metallurgy, Butte, Mont.

Nebraska. — Nebraska Geological Survey; G. E. Condra, State Geologist, Lincoln.

Nevada. — A. J. Stinson, Inspector of Mines, Carson City.

New Jersey. — Geological Survey of New Jersey; H. B. Kummel, State Geologist, Trenton.

New Mexico. — New Mexico Geological Survey; R. W. Ellis, State Geologist, University of New Mexico, Albuquerque.

New York. — Science Division (Geological Survey) of the Educational Department; D. H. Newland, State Geologist, Albany.

North Carolina. — North Carolina Geological and Economic Survey; H. J. Bryson, State Geologist, Raleigh.

North Dakota. — North Dakota Geological Survey; A. G. Leonard, State Geologist, University.

Ohio. — Geological Survey of Ohio; W. Stout, State Geologist, Columbus.

Oklahoma. — Oklahoma Geological Survey; C. N. Gould, State Geologist, Norman.

Oregon. — Oregon Bureau of Mines and Geology; C. E. Newton, Director, Corvallis.

Pennsylvania. — Topographical and Geological Survey Commission; George H. Ashley, State Geologist, Harrisburg.

Rhode Island. — Natural Resources Survey of Rhode Island; C. W. Brown, Superintendent, Providence.

South Carolina. — Stephen Taber, State Geologist, University of South Carolina, Columbia.

South Dakota. — Geological Survey of South Dakota; E. P. Rothrock, Acting State Geologist, Vermillion.

Tennessee. — Tennessee State Geological Survey; W. F. Pond, State Geologist, Nashville.

Texas. — University of Texas, Bureau of Economic Geology and Technology; J. A. Udden, Director, Bureau of Economic Geology and Technology, Austin.

Utah. — William Peterson, State Geologist, Logan.

Vermont. — Geological Survey of Vermont; G. H. Perkins, State Geologist, Burlington.

Virginia. — Virginia Geological Survey; A. C. Bevan, Director, Charlottesville.

Washington. — State Geological Survey of the State of Washington; H. E. Culver, State Geologist, Pullman.

West Virginia. — West Virginia Geological and Economic Survey; J. D. Sisler, State Geologist, Morgantown.

Wisconsin. — Wisconsin Geological and Natural History Survey; E. F. Bean, State Geologist, Madison.

Wyoming. — Geological Survey of Wyoming; J. G. Marzel, State Geologist, Cheyenne.

Canada

Department of Mines, Charles Camsell, Deputy Minister; Geological Survey Branch. W. H. Collins, Director, Ottawa; Mines Branch, J. McLeish, Director, Ottawa.

Quebec. — Department of Mines; Theo. Denis, Superintendent of Mines, Quebec.
Ontario. — Bureau of Mines; A. G. Burrows, Provincial Geologist, Toronto.
British Columbia. — Bureau of Mines; W. F. Robertson, Provincial Geologist.

Mexico

Geological Survey of Mexico. J. G. Aguilera, Director, Mexico City.

INDEX

A

Abrasion, by weathering, 229
 Acadian, 656
 Acids, in river water, 303
 Acre foot, 260
 Actinolite, 18, 19
 Adobe, 113, 536
 Adirondacks, 80, 146, 440
 Aegerite, 15
 Aeolian deposits, 111
 Agate, 30
 Age, geologic, 651
 Agglomerate, volcanic, 92
 Alabama, 34, 136, 144, 255, 482, 486, 490, 495, 499, 557, 567, 568, 569, 584, 607, 629, 634, 640, 653, 663, 666, 667, 670, 671, 676
 Alabaster, 38
 Alaska, 89, 193, 430, 433, 435, 581, 608, 644, 663, 667, 671, 679, 681, 685, 687
 Alberta, 366
 Albertite, 586
 Albite, 8
 Alexandrian series, 663
 Algonkian, 652, 655
 Allegheny series, 670
 Almandite, 20
 Alps, 687
 Alunitization, 618
 Amphibole, 17
 Amygdaloidal, 69
 Amygdules, 69
 Analcite, 28
 Analyses of basalts, 89; bitumens, 585; cannel coal, 549; clays, 532; coal, 552; coke, 561, 562; coke oven tars, 564; diorite, 79; felsites, 87; gabbro, 80; gases, manufactured, 577; gneisses, 130; gypsum rock, 524; hydraulic lime, 513; hydraulic limestone, 513; lake waters, 424; limestone, 510; mine waters, 609; natural cement rocks, 514; natural gas, 576; peat, 546; peridotite, 82; plutonic rocks, 62; Portland cement materials, 515; producer gas, 555; puzzolan cement materials, 520; pyroxenite, 84; rocks and decomposition products, 240; residual clay, 240; river waters, 299, 300; schiste, 135; sedimentary rocks, 100; serpentine, 145; slag cement materials, 520; slate, 140; soapstone, 145; syenite, 77; volcanic fragmental rocks, 93; volcanic glass, 90
 Anamorphism, 212
 Andradite, 20
 Angle of pull, 369
 Angle of rest, 368
 Angle of slide, 368
 Anglesite, 43
 Anhydrite, mineral, 39; rock, 115, 524
 Anorthite, 8
 Anorthosite, 80
 Anthracite, 549

Anticline, 151
 Anticlinorium, 153
 Apatite, 39
 Apex, ore bodies, 620
 Aphanitic texture, 67
 Aplite, 75
 Appalachians, 188, 235, 490
 Aqueducts, relation to, faults, 190; glacial deposits, 444; limestone, 121; rivers, 294
 Aquifer, defined, 321; depth of, 338; source of water in, 338
 Aragonite, 36
 Archean, 654
 Archeozoic era, 652
 Arfvedsonite, 18, 19
 Arizona, 255, 373, 487, 489, 568, 572, 581, 621, 638, 655, 675, 679
 Arkansas, 117, 237, 240, 463, 464, 486, 505, 552, 560, 568, 572, 600, 660, 661, 663, 671, 676
 Arkose, 108
 Artesian basin, 321
 Artesian flow, requisite conditions of, 327
 Artesian water, defined, 321; factors affecting supply, 335; in crystalline rocks, 332; in stratified rocks, 327; provinces, 340
 Artesian well, 321; blowing, 339; breathing, 339; interference, 337; irregular behavior, 338; irregularities of supply, 336; yield of, 337
 Ash, volcanic, 92
 Ashokan dam, 97, 111
 Asphalt, 586
 Asphaltenes, 586
 Atlantic Coastal Plain, 328
 Australia, 338, 675
 Augen gneiss, 131
 Augite, 15

B

Bahamas, 114
 Bar, ocean, 389
 Barbados, 587
 Barrier beach, 387
 Base level, 264
 Bastin, E. S., 127
 Basalt, 87
 Batholith, 56
 Beach, barrier, 387; formation of, 385
 Beck, R., 624
 Becraft limestone, 667
 Bedford stone, 491
 Beckmantown formation, 660
 Bedding, 98
 Bed rock, 149
 Belgium, 658
 Berkey, C. P., 111
 Bermuda, 114
 Biotite, 12
 Bitumens, solid, 584; vein, 585
 Bituminous coal, properties of, 547

Bituminous rocks, 587
 Black band ore, 118
 Black lignite, 547
 Black waxy clay, 594
 Blowing wells, 339
 Bog lime, 121
 Bohemia, 89, 240
 Boiler scale, 347
 Bombs, volcanic, 92
 Bonanza, 620
 Bone in coal, 570
 Bonneville, Lake, 691
 Bore, tidal, 396
 Boss, 55
 Boulder clay, 438
 Boulder quarry, 480
 Branner, J. C., 233
 Brazil, 233
 Breaching wells, 339
 Breccia, eruptive, 102; fault, 102, 175; fold, 104; friction, 102, sedimentary, 101; solution, 104; talus, 101; uses of, 104; volcanic, 92
 Brick, manufacture of, 538
 Bridges, affected by subsidence, 373
 Briquettes, coal, 565
 British Columbia, 82, 188, 358, 424, 426, 656, 679, 681, 682
 Brown coal, 546
 Bryan, K., 108, 316
 Buckman, H. O., 242
 Buckley, E. R., 227, 418, 458, 459, 460, 462, 472
 Buhstone, 137
 Building stone, abrasive resistance, 469, absorption, 455, chemical composition, 474, crushing strength, 457, durability, 449; effect of atmospheric gases on, 437, expansion, 468; factors governing selection of, 147, fire resistance, 464; frost resistance, 171, injurious minerals, 451, joints, 448; kinds of rock used, 447, 475, life of, 450, microscopic examination, 474, mineral composition, 450; modulus of elasticity, 469, physical properties, 455; porosity, 456; preservation, 453; quarry water, 450; structural features, 448, 449, texture, 449, transverse strength, 461
 Bumps, in coal mines, 554
 Buried channels, 442
 Burlington beds, 670

C

Cables, submarine, relation to, faults, 193
 Canstone, 491
 Calc sinter, 123
 Calcareous tufa, 123
 Calcareous limestone, 660
 Calcite, 35
 California, 55, 79, 89, 90, 93, 117, 130, 135, 144, 145, 147, 190, 254, 263, 278, 279, 299, 311, 328, 345, 416, 424, 464, 482, 485, 489, 490, 500, 515, 552, 560, 568, 573, 575, 581, 583, 585, 587, 589, 608, 616, 630, 640, 644, 663, 667, 671, 679, 681, 682, 685
 Cambrian system, 656
 Camptonite, 79
 Canada, 42, 53, 56, 80, 82, 116, 147, 264, 330, 439, 440, 515, 547, 557, 591, 636, 640, 644, 656, 663, 667, 671, 676, 677
 Canadian stage, 660
 Cannel coal, properties of, 549

Cape Verde Islands, 89
 Capillary interstices, 323
 Carbonaceous rocks, 123
 Carbonates, in water, 302
 Carbonation, weathering, 236
 Carboniferous system, 670
 Carbonite, 562
 Cascade formations, 682
 Catskill aqueduct, 190, 292
 Catskill beds, 667
 Cayugan series, 663
 Cementation index, 520
 Cenozoic era, 684
 Centrocinal, 153
 Cerussite, 43
 Chalcedony, 30
 Chalcopyrite, 42
 Chalk, 121
 Chamberlin, R. T., 181
 Chamberlin, T. C., 113, 265, 325, 426, 441, 687
 Chautauquan series, 667
 Chazvan, 660
 Chemung beds, 667
 Chert, 117, 493; for roads, 597
 Chico series, 682
 Chimney, 620
 China, 113
 Chlorine, in river water, 301
 Chlorite, 27
 Choisy, M., 229
 Chrysotile, 27
 Cinnamon, 660
 Clackamas River, Ore., 59
 Clapp, F. G., 333, 334
 Clarke, F. W., cited, 1, 64, 99, 110, 301, 608
 Clay, boulder, 438, brick, 536; brick, manufacture, 538, composition of, 532, distribution, 542, for roads, 594, kinds of, 536; occurrence of, 533; properties of, 527; residual, 240, 533, sewer pipe, manufacture, 541, slides, 359, transported, 534; uses of, 536; water in, 330
 Cleavage, false, 500; flow, 199; fracture, 199; in minerals, 4; in slate, 500; rock, 198; rock, cause of, 202, slaty, 199; slip, 500
 Cement, grappier, 513, high alumina, 520; hydraulic limes, 512, distribution, 521; natural, 514, plaster, 525, Portland, 514; Puzzolan, 518; Scott's, 514, selenitic limes, 514; slag, 518
 Clinoclone, 27
 Clinometer, 150
 Clinton stage, 663
 Coal, analyses of, 552; briquetting, 565; calorific power, 560; classification, 557; coke, 547; composition of, 550; distribution, 567; escape of gas from, 567; for gas, 564; geologic distribution, 568; grade, defined, 553, kinds of, 544; measures, 670; origin, 559; proximate analysis, 550; rank defined, 544; specific gravity, 557; structural features, 553; volatile matter, 551
 Coastal Plain, 338
 Cobleskill limestone, 663
 Coeymans limestone, 667
 Coke, 547, 561
 Collecting area, 327
 Colluvial deposits, 240
 Color, minerals, 5
 Colorado, 89, 90, 108, 144, 229, 254, 336, 343, 364, 365, 366, 372, 415, 482, 487, 489, 490, 550, 552,

562, 568, 573, 581, 586, 589, 616, 617, 621, 630, 642, 656, 661, 671, 675, 679, 683.
 Colorado river, overflow of, 263
 Comagmatic area, 70
 Comanchean system, 681
 Concretions, 206
 Conemaugh series, 670
 Conglomerate, for roads, 602; sedimentary, 104; volcanic, 92, 105; water in, 328
 Connate water, 305
 Connecticut, 89, 333, 335, 451, 463, 464, 468, 483, 510
 Consanguinity, rocks, 70
 Contact metamorphism, 214
 Copper, ore minerals, 637; ore bodies, types of, 638
 Coquina, 123, 491
 Coral rock, 123
 Cortlandite, 82
 Corundum, 31
 Crenothrix, 348
 Cretaceous system, 681
 Croixian, 656
 Cross fracture, slate, 503
 Crushed stone, 89
 Crushing strength of rocks, 477, 488, 493, 494, 497
 Crustification, ores, 612, 618
 Crystal, defined, 2; systems, 2; twinning, 2
 Cuba, 237
 Culm, 570
 Cumulose deposits, 249
 Cut off, in rocks, 480

D

Dale, T. N., 500
 Dams, geology of, 446a: relation to, glacial drift, 444; folds, 161; lava flows, 59; rivers, 294; subsurface water, 349
 Davis, C. A., 430
 Davis, W. M., 411
 Day, D. T., 577
 Dehydration, weathering, 233
 Deoxidation, weathering, 236
 Devonian system, 666
 Diabase, 81; for building, 486
 Diatomaceous earth, 117
 Dickinson, H. T., 108
 Differentiation, igneous rocks, 69
 Dikes, complementary, 69; defined, 50; relation to quarrying, 482
 Diopside, 15
 Diorite, 78
 Dip, 150
 Disseminated ore, 621
 District of Columbia, 233, 240
 Dolomite, mineral, 36
 Dolomite, rock, 121
 Dolomite, weathering of, 247
 Dolomitization, 121
 Drainage, by wells, 321
 Drift, see Glacial drift
 Drinker, H. S., 358
 Dunes, 113
 Dunite, 82

E

Earthquakes, relation to faults, 191
 Earth's crust, composition, 1

Effluent streams, 449a
 Ellis, A. J., 333
 Embankments, sliding of, 365
 Emmons, W. H., 640
 Endomorphism, 214
 England, see Great Britain
 Enstatite, 15
 Eocene, 684
 Eozoic, 652
 Epidote, 22
 Epoch, geologic, 651
 Era, geologic, 651
 Erian series, 667
 Eskers, 439
 Esopus grit, 667
 Essential minerals, 64
 Excavation deformation, 369
 Excavation, in serpentine, 147
 Exomorphism, 215
 Extrusive rocks, 56

F

Fahlband, 621
 Falls, river, 272
 Faults, block, 180; classes of, 180; criteria of, 175; definition, 174; determination, 193; displacement, kinds of, 177; geologic effects, 185; normal, 181; overthrust, 181; relation to engineering work, 188; relation to dams, 461a; relation to folds, 187; reverse, 181; terms, 174; topographic effects, 184
 Fayalite, 20
 Felsitic texture, 67
 Feldspars, 7
 Feldspathoids, 12
 Felsite, 86
 Fenneman, N. M., 418
 Field, B. C., 188
 Fire clay, 536
 Fire damp, 507
 Fissility, 199
 Fissure veins, 618
 Flagstone, 108
 Flint, 30, 117, 451
 Float, ore, 627
 Flooring plaster, 525
 Florida, 123, 305, 318, 321, 379, 405, 408, 428, 429, 430, 491, 552, 685
 Folds, 149; anticlines, 151; anticlinorium, 153; asymmetrical, 156; axial plane, 151; cause of, 201; centroclinal, 153; close, 156; composite, 151; drag, 156; erosion of, 156; field measurements, 162; geanticline, 153; geosyncline, 153; limbs of, 151; monocline, 152; open, 156; parallel, 156; parts of, 151; pitch of, 151; quaquaversal, 152; recumbent, 156; relation to dams, 161; relation to engineering work, 159; relation to mining, 161; relation to ore deposits, 161; relation to quarrying, 160; similar, 156; simple, 151; syncline, 151; synclinorium, 153; upright, 156
 Foliated, 127
 Foliation, 199
 Footwall, 175, 620
 Formation, 99
 Forsterite, 20
 Fossils, preservation, 648; rocks in which found, 648; uses, 649
 Foundation work, relation to ground water, 352

- Foundations, road, 591
 Fracture, minerals, 6
 Fragmental texture, 69
 France, 121, 231, 240, 373, 379, 491, 494, 510, 520, 658, 667, 675, 691
 Freestone, 108
 Frontal aprons, glacial, 439
 Frost action, 226
 Fuller, M. T., 324, 325, 338
- Gabbro, 80; for building, 486; for roads, 602
 Gaillard, D. D., 379
 Galena, 43
 Gangue, 606
 Garnet, 20
 Gas, see Natural gas
 Gas, producer, 564
 Geanticline, 153
 Geikie, A., 435
 Genesee shale, 667
 Geologic time, subdivisions, 651
 Geological surveys, 695
 Georgia, 26, 34, 55, 144, 147, 240, 255, 321, 463, 483, 497, 499, 500, 513, 515, 567, 661, 670
 Georgian, beds, 656
 Geosyncline, 153
 Germany, 90, 117, 121, 131, 373, 513, 520 667, 675, 676
 Geyserite, 30, 117
 Giant's Causeway, 87
 Gilbert, G. K., 54, 229, 279
 Gilsonite, 586
 Glacial deposits, 690, economic materials in, 446; kind and nature of, 438, water in, 328
 Glacial drift, distribution, 440, lakes in, 415, relation to dams, 444; relation to engineering work, 442, 444; relation to reservoirs, 443, relation to subsurface water, 443; topography of, 441; water in, 330
 Glacial period, 687, 690
 Glaciation, past, 439; relation to water power, 446
 Glaciers, deposits of, 437; effects of, 435; effect on railroads, 435; erosion by, 436; moraines, 437; origin, 432; transportation by, 437; types of, 433
 Glance pitch, 587
 Glassy texture, 67
 Gneiss, 129
 Gneissic structure, 200
 Gold, gravels, 644; occurrence of, 643; ore minerals, 643
 Gossan, 625
 Gouge, fault, 175; in ore bodies, 620
 Grahamite, 586
 Grain, in rock, 480; in slate, 501
 Granite, 74; as building stone, 475; distribution, 482; for roads, 602; uses, 482
 Granitoid texture, 67
 Grano-diorite, 79
 Granulite, 131
 Graphic granite, 75
 Grappier cement, 513
 Gratton, L. C., 640
 Gravel, 94; field examination, 595; requirements for roads, 595; testing, 596; uses, 95; water in, 328
 Graywacke, 108
- Great Britain, 57, 117, 121, 373, 379, 381, 513, 658, 667, 668, 675
 Greenbrier series, 670
 Greenland, 687
 Green Mountains, 146
 Greenstone schist, 135
 Greisen, 614
 Greisenization, 618
 Grit, 108
 Grossularite, 20
 Groundwater, 308; amount of, 324; composition of, 346; provinces, 340
 Group, geologic, 651
 Guelph limestone, 663
 Gumbo, 536, 594
 Gypsite, 522
 Gypsum, mineral, 37; calcination, 524; distribution, 525, earth, 522, plasters, 522; rock, 115; chemical composition, 524; weathering of, 248
- II
- Hamilton shale, 667
 Hanging valleys, 437
 Hanging wall, 175, 620
 Harbor improvement, 396
 Harcourt, V., 381
 Hardness, minerals, 3
 Hardway, in rocks, 480
 Harker, A., 65
 Harzburgite, 82
 Haupt, L., 383
 Hawaiian Islands, 93, 334
 Hayes, C. W., 163
 Heave, of faults, 179
 Heim, A., 357
 Helderbergian series, 667
 Hematite, 33
 Henry Mountains, 54
 Heulandite, 28
 Hewett, D. F., 163
 Historic geology, 646
 Hooks, 389
 Hornblende, 18, 19
 Hornblendeite, 84
 Hornstone, 117
 Horse, in fault, 175
 Hungary, 272
 Huronian system, 655
 Hydatogenesis, 614
 Hydration, weathering, 232
 Hydraulic limes, 512
 Hydraulic limestone, 123
 Hydrostatic level, 322
 Hypersthene, 15
- I
- Iceland, 57
 Ice ramparts, 416
 Idaho, 89, 123, 254, 305, 344, 568, 616, 620, 630
 Igneous rocks, as building stone, 475; chemical composition, 60; classification, 70; differentiation, 69; glassy, 89; mineral composition, 63; porphyritic, 91, pyroclastic, 92; texture, 66; volcanic, 85; water in, 332; weathering of, 244
 Illinois, 255, 301, 373, 440, 444, 494, 514, 521, 536, 552, 560, 568, 570, 575, 583, 661, 667, 670, 673

- Ilmenite, 32
 Imperial valley, overflow in, 263
 Impsonite, 585
 India, 57, 675
 Indiana, 320, 321, 329, 440, 463, 468, 491, 493, 494, 495, 515, 522, 549, 564, 568, 583, 584, 661, 667, 670
 Influent streams, 450a
 Infusorial earth, 117
 Inliers, 205
 Intrusive rocks, 48
 Iowa, 329, 336, 337, 440, 458, 459, 525, 532, 568, 572, 661, 663, 667, 671
 Iron, ore minerals, 631
 Iron ores, 118, 630; types of, 631
 Isopiestic line, 322
 Itacolomite, 137
 Italy, 520
- J
- Jasper, 30, 117
 Jaspilite, 117
 Johnson, D. W., 378
 Joints, 169; blind, 199; cause of, 202; classification, 171; igneous rocks, 172; metamorphic rocks, 172; relation to engineering work, 173; to dams, 461a; sedimentary rock, 171
 Jurassic system, 679
- K
- Kames, 439
 Kansas, 116, 514, 522, 525, 526, 560, 568, 572, 576, 583, 671, 673, 675
 Kaolin, 536
 Kaolinite, 24
 Kaskasia series, 670
 Katamorphism, 212
 Keene's cement, 525
 Keewatin, 652
 Keweenawan, 655
 Kemp, J. F., 72, 91
 Kentucky, 321, 330, 365, 463, 494, 514, 521, 549, 560, 567, 568, 581, 583, 589, 667, 670, 673
 Keokuk beds, 670
 Kerogen, 589
 Kersantite, 79
 Kinderhook series, 670
 Kingston beds, 667
 Knots, in building stone, 480
 Kootenay formations, 682
- L
- Laccoliths, 53
 Lafarge cement, 513
 Lafayette formation, 685
 Lakes, area of, 412; composition of water, 423; crater, 416; crustal movement, 414; currents in, 418; definition of, 411; drift dam, 415; extinct, 427; ice ramparts in, 416; inlet, 412; landslide, 415; lava dam, 415; level variations, 418; obliteration of, 423; overturning, 420; ox bow, 412; relation to engineering work, 411; sink hole, 414; temperature, 419; types of, 411; wave action in, 416; working of, 420
 Lamination, 98
 Landslides, 357; angle of pull, 369; angle of
- rest, 368; angle of slide, 368; classification, 357; clay, 359; effect of surface water on, 349; factors affecting, 370; lakes, 415; relation to faults, 193; relation to reservoirs, 372; relation to roads, 593
 Land subsidence, 373; effect on agriculture, 373; effect on bridges, 373; effect on canals, 373; relation to subsurface water, 351
 Laney, F. B., 459
 Lapilli, 92
 Laramie, 682
 Laterite, 237
 Laterization, 237
 Laurentian, 652
 Lava flows, 57
 Layer, 99
 Lead, ore minerals, 641
 Lead ore, weathering, 641; classification, 641; mode of occurrence, 642
 Lees Ferry, Colo., 108
 Leith, C. K., 201
 Lepidolite, 12
 Lepidomelane, 12
 Levees, 271
 Level, changes of, 601
 Lherzolite, 84
 Lignite, properties, 546
 Lime, 511
 Lime materials, distribution, 521
 Limestone, changes in burning, 511; chemical composition, 493, 510; defined, 118; distribution, 495; for building, 490; for cement, 516; for roads, 603; properties of, 491; structural features, 490; varieties, 121; water in, 329; weathering of, 247
 Limonite, 34
 Lithographic limestone, 123
 Lockpost stage, 663
 Lode, 620
 Loess, 111, 536
 Lorraine beds, 660
 Louisiana, 116, 568, 583, 584, 685
 Lowville stage, 660
 Luster, minerals, 4
- M
- MacDonald, 371
 McCourt, W. E., 465
 Mack's cement, 525
 Magmatic water, 305
 Magnetite, 32
 Maine, 90, 333, 335, 408, 424, 429, 447, 463, 468, 482, 483, 504, 560, 663, 667, 668
 Maltha, 585, 587
 Man, appearance of, 691
 Mangrove swamps, 429
 Manjak, 587
 Manlius limestone, 663
 Mapping, geologic, 217
 Marble, definition, 142; distribution, 499; properties of, 495; uses, 499
 Marcasite, 42
 Marcellus shale, 667
 Marl, 121
 Maryland, 82, 85, 117, 135, 247, 464, 468, 483, 497, 499, 500, 505, 510, 513, 514, 521, 560, 567, 569, 670, 675, 685
 Massachusetts, 144, 145, 231, 240, 396, 408, 420, 464, 468, 483, 489, 490, 500, 504, 552, 564

Mauch Chunk series, 670
 Medina sandstone, 663
 Median series, 663
 Meinzer, O. H., 321, 323, 328, 330, 335, 340
 Merrill, G. P., 233, 247, 250, 249, 459
 Mertie, Jr., J. B., 164
 Mesozoic era, 677
 Metamorphic rocks, 124, chemical composition, 126; classification, 124, criteria of origin, 127; minerals of, 126; structure of, 127; texture of, 126; water in, 332
 Metamorphism, agents of, 124, 211; contact, 214; defined, 207; kinds of, 212, regional, 216; zones of, 212
 Metasomatism, 612
 Meteoric water, 305; disposal of, 305
 Mexico, 87, 93, 487, 679, 682
 Mirolitic, 69
 Mica, mineral, 12; in building stones, 451, 407
 Michigan, 80, 82, 113, 116, 255, 320, 330, 418, 424, 430, 489, 494, 510, 515, 522, 525, 536, 568, 572, 581, 630, 638, 653, 656, 666, 667, 670
 Millstone grit, 670
 Mineralizers, 65
 Minerals, chemical tests, 7; color, 4, crystal form, 5; defined, 1; essential, in rocks, 64; expansion coefficient, 226, fracture of, 6; hardness, 3, order of crystallization, 65, properties, 3; resistance to weathering, 242, specific gravity, 6; streak, 4
 Miner's inch, 258
 Minette, 78
 Minnesota, 80, 82, 130, 135, 320, 321, 424, 430, 440, 441, 463, 482, 485, 486, 489, 490, 514, 656, 667
 Miocene, 684
 Mississippi, 281, 568, 575
 Mississippi River, improvement, 407
 Mississippi Valley, 113
 Missouri, 144, 458, 459, 472, 482, 485, 489, 494, 499, 532, 568, 572, 581, 629, 641, 642, 643, 653, 656, 666, 663, 667, 671
 Mohawkian, 660
 Mohs' scale, 3
 Monocline, 152
 Monongahela series, 670
 Montana, 192, 318, 415, 487, 489, 552, 559, 560, 568, 616, 655, 675, 679
 Montreal, Can., 51
 Monzonite, 77
 Moraines, glacial, 438
 Mountain forming periods, 676, 681
 Mountain making movements, 684, 687
 Muscovite, 12
 Muskegs, 427

N

Natrolite, 28
 Natural gas, analyses of, 576; distribution, 584, occurrence of, 577; properties of, 576
 Nebraska, 568, 671, 675
 Necks, volcanic, 54
 Neocene, 684
 Nephelite, 12
 Nevada, 117, 254, 335, 423, 424, 617, 630, 638, 644, 656, 663, 675, 679, 691
 Nèvé, defined, 433
 New Brunswick, 524, 526, 586, 663, 667, 668, 670, 675, 676

New Caledonia, 237
 Newfoundland, 429, 633, 656, 663, 676
 New Hampshire, 463, 483
 New Jersey, 130, 145, 382, 383, 387, 392, 396, 398, 408, 428, 483, 486, 500, 510, 633, 640, 641, 642
 Newland, D. H., 359
 New Mexico, 55, 114, 254, 522, 550, 552, 562, 568, 572, 573, 581, 642, 654, 675, 679
 New Scotland beds, 667
 New York, 27, 80, 82, 116, 144, 145, 146, 190, 193, 229, 240, 248, 255, 285, 290, 292, 313, 326, 328, 341, 349, 360, 396, 408, 415, 424, 436, 437, 440, 441, 442, 443, 444, 463, 465, 468, 483, 486, 488, 489, 490, 495, 497, 500, 505, 510, 513, 514, 515, 521, 522, 525, 564, 584, 603, 607, 629, 631, 633, 653, 656, 659, 660, 663, 665, 666, 667, 668, 670, 676
 New Zealand, 82
 Niagaran series, 663
 Norite, 81
 North Carolina, 82, 145, 255, 338, 428, 459, 460, 483, 490, 532, 568, 640, 677, 679
 North Dakota, 254, 424, 446, 552, 568, 580
 Norway, 82, 85
 Novaculite, 117
 Nova Scotia, 391, 429, 524, 526, 585, 633, 663, 667, 668, 670, 675, 676, 677

O

Obsidian, 90
 Offset, fault, 180
 Ohio, 255, 293, 329, 440, 468, 489, 490, 522, 525, 532, 556, 567, 569, 570, 581, 583, 584, 608, 633, 661, 665, 666, 667, 668, 670, 673, 675
 Oil, see Petroleum
 Oil shale, 589
 Oklahoma, 482, 485, 526, 568, 583, 584, 585, 586, 589, 653, 660, 663, 667, 671, 673, 675, 676
 Oligocene, 684
 Olivine, 21
 Onondaga conglomerate, 663
 Onondaga limestone, 667
 Ontario, 80, 414, 459, 607, 616, 653
 Onyx, 30, 123, 499
 Oolite, 123
 Ophicalcite, 27, 145
 Ophiolite, 27, 145
 Ordovician system, 659
 Ore deposits bedded, 607; concentration of, 609; contact metamorphic, 615; contemporaneous, 607, deep vein zone, 615; definition, 606, distribution, 627; epigenetic, 608, forms of, 618, hydrothermal alteration, 617, intermediate vein zone, 616, magmatic segregation, 607; origin, 607, outcrop, 627; physical condition, 614; relation to faults, 191, relation to joints, 174; secondary enrichment, 625; shallow vein zone, 616; subsequent, 608; surface deposits, 617; syngenetic, 607; weathering of, 622
 Ore deposits, see Ores
 Oregon, 59, 89, 115, 147, 254, 318, 351, 406, 414, 415, 416, 568, 573, 667, 669, 682
 Ore minerals, 606
 Ores, change with depth, 626; copper, 637; definition, 606; deposition of, 611; gold, 643; iron, 630; lead, 641; replacement, 612; silver, 643; zinc, 640
 Ore shoots, 621
 Oriskanian series, 667

Oriskany sandstone, 667
 Orthoclase, 8
 Osage series, 670
 Oscillatory waves, 377
 Outcrop, 149; effect of faulting on, 184; relation to topography, 196
 Outliers, 205
 Outwash plain, 439
 Overlap, 204
 Overthrust, 181
 Oxidation, weathering, 233
 Ozokerite, 585

P

Paleozoic, disturbances, 676
 Paleozoic era, 655
 Palmer, A. W., 301
 Palmer, H. S., 164
 Panama Canal, 361, 370
 Parks, A. W., 458
 Peat, 544
 Pegmatite, 75
 Peneplain, 265, 288
 Pennsylvania, 120, 130, 258, 293, 303, 349, 365, 489, 490, 499, 500, 504, 505, 514, 521, 522, 550, 552, 556, 559, 560, 564, 567, 569, 570, 575, 583, 584, 631, 661, 668, 670, 671, 673, 675
 Perched, stream, 451a; water table, 314
 Peridotite, 82
 Period, geologic, 651
 Perknite, 85
 Perlite, 90
 Permeability, of rocks, 325
 Permian system, 673
 Petroleum, distribution, 581; indications, 580; occurrence of, 577; origin, 580; properties, 575; relation to faults, 192; sands, structure of, 579; well pressure, 578; wells, yield of, 579
 Phlogopite, 12
 Phreatic water, 308
 Phosphate rock, 123
 Phosphorite, 123
 Phyllite, 139, 142
 Piezometric surface, 322
 Pirsson, L. V., 72, 100
 Pisolitic, 123
 Pitchstone, 90
 Plants, as weathering agents, 231
 Plaster, gypsum, 522; kinds of, 525
 Plaster of Paris, 38
 Playa, 425
 Pleistocene, 687
 Pliocene, 684
 Plutonic rocks, 48
 Pneumatolysis, 614
 Pocono series, 670
 Poikilitic, 84
 Porphyries, 91
 Porphyritic texture, 67
 Portage beds, 667
 Pot-holes, rivers, 272
 Potomac series, 682
 Potsdam, 656
 Pottsville series, 670
 Pre-Cambrian, 652
 Prince Edward Island, 675
 Producer gas, 564
 Propylitization, 617
 Proterozoic, 652

Protore, definition, 606, 627
 Prussia, 93
 Pudding stone, 105
 Puddle, clay, 542
 Pumice, 90
 Pumiceous, 69
 Pyrenees, 85
 Pyrite, mineral, 41; in building stones, 453, 497, 503
 Pyrobitumens, 585
 Pyroclastic, rocks, 56
 Pyrope, 20
 Pyrrhotite, 42
 Pyroxene, 15
 Pyroxenite, 84

Q

Quaquaversal, 152
 Quarrying, relation to, dikes, 482; faults, 193; folds, 160; glacial drift, 444; joints, 173, 448
 Quarry water, 450
 Quartz, 29
 Quartzite, 137; distribution, 190; for building, 487; for roads, 602; uses, 139
 Quaternary system, 687
 Quebec, 360, 667, 668

R

Railroad ballast, clay, 541
 Railroads, relation to, faulting, 188; folding, 159; glaciers, 442; sand dunes, 115; subsurface water, 352; swamps, 429; talus slopes, 358
 Rainfall, 252, 305
 Reade, T. M., 238
 Recent epoch, 684
 Red beds, 675
 Reeds, in sandstone, 11
 Replacement, 612
 Reservoirs, geology of, 446a; relation to, faults, 191; glacial drift, 443, 444; joints, 173; landslides, 372; lava flows, 59; water table, 313; subsurface waters, 349; see also Dams
 Residual, clay, 240; ores, 621; sand, 240
 Rhode Island, 483, 670, 676
 Richardson, C., 585, 586, 589
 Richmond beds, 660
 Rift, 480
 Rivers, aggrading, 279; alluvial plain, 279; bank erosion, 270; bars at mouth of, 400; bars in channel, 287; base level, 264; basin, 258; boils, 269; buried channels, 290; canyons, 290; channel deposits, 278; corrosion by, 262; dam foundations, 294; delta, 281; deposition, 277; discharge of, 256; dissolved load, 277; eddies, 269; erosion by, 261; erosion, depth of, 264; erosion, factors influencing, 262; falls in, 272; floods, 292; formation of, 256; gorges, 290; ice gorges, 294; intermittent, 256; levees, 271; meandering, 265; measurement of, 258; outlets of, 287; ox bow, 267; permanent, 256; piracy, 288; pot-holes, 272; relation particle size to velocity, 275; scour, 267; sediment transported by, 274; shoals, 267; slope of, 276; temporary, 256; terraces, 285; tidal improvement, 403; transportation by, 272;

- valley development, 287; water, composition, 296; water, soluble matter in, 238; young, 289
- Road foundations, 591
- Road materials, 593; blocks, 603; clay, 542, 594; field study of, 595, 598; gravel, 595; sand, 594; stone, 602; tests, 598
- Roads, geological features of, 591
- Rochester shale, 663
- Rock falls, 366
- Rocks, bituminous, 587; definition, 45; expansion coefficient, 226; extrusive, 56; for roads, 597; igneous, 47; intrusive, 48, 56; metamorphic, 124; permeability of, 325; plutonic, 48; porosity of, 320, 324, properties for roads, 598, 602; pyroclastic, 56; sedimentary, 93, spaces in, 323; tests for roads, 598; water capacity of, 323; weathering of, 223, 244
- Rock salt, 116
- Rocky Mountains, 56, 328, 432
- Rogers, H. D., 549
- Rottenstone, 239
- Run, in granite, 480
- Run-off, 307; factors controlling, 252; ratio to rainfall, 253
- Russell, I. C., 238
- Russia, 430, 675
- S
- Sacramento River, case of, 278
- Sahara desert, 229
- St. Louis series, 670
- Salina series, 663
- Salinity, 298
- Salisbury, R. D., 113, 265, 325, 426, 441, 687
- Salt, rock, 116
- Salton sink, case of, 263
- Sand, dunes, 113, properties, 95; residual, 240; roads, 594; sieve tests, 96; uses, 95; water in, 328
- Sandstones, distribution, 490, for building, 487; properties, 105, 487; structural features, 487; variation in, 111; varieties, 108; water in, 328; weathering of, 246
- Sanford, S., 334, 337
- Saursurization, 82
- Saxonite, 82
- Schistose, 127
- Schistosity, 200
- Schists, 134; for roads, 602; uses, 136
- Scoharie grit, 667
- Scoriaceous, 69
- Secondary minerals, 64
- Second foot, 258, 260
- Sections, geologic, construction of, 219
- Sedimentary rocks, 93; chemical precipitates, 115; classification, 99; composition, 99; consolidation, 97; eolian, 111; mechanical, 101; shale, 110; structure, 98; texture, 94; weathering of, 246
- Seepage, 314
- Seiches, 419
- Selenite, 38
- Selkirk Mountains, 432
- Selvage, 620
- Semianthracite coal, 549
- Semibituminous coal, properties of, 549
- Senecan series, 667
- Sericite schist, 135
- Sericitization, 618
- Series, geologic, 651
- Serpentine, 26
- Serpentine marble, 499
- Serpentine rock, 146
- Sewer pipe, manufacture of, 541
- Shale, 110; for roads, 603; variations in, 111; water in, 330; weathering of, 247
- Shastan group, 682
- Sheets, defined, 51; in quarries, 480
- Shell, marl, 121
- Shift, fault, 178
- Shore currents, 385
- Shore drift, 405
- Shore line, changes, 392
- Sierra Nevada, 56
- Silicification, 618
- Silurian system, 661
- Silver, occurrence of, 643, ore minerals, 643
- Sink holes, 414
- Sinter, siliceous, 30
- Slag cement, 518
- Slate, 139, classification, 505; cleavage, 500; distribution, 505, for roads, 602; grain, 501; properties of, 501, structural features, 500; uses, 505
- Slaty, defined, 127
- Shkenskides, 175
- Slides, see Landslides
- Slip, fault, 177
- Snow fields, 432
- Soapstone, 25, 147; uses, 148
- Sodalite, 12
- Soil, 250; areas, 250; classification, 249; composition, 250; definition, 249; formation of, 249, sedentary, 249, transported, 249
- Soluble salts, disintegration by, 227
- Solution, weathering, 237
- South Africa, 675
- South America, 675
- South Carolina, 123, 255, 483, 677
- South Dakota, 342, 482, 510, 568, 621, 630, 644, 653, 654, 661
- Specific gravity, minerals, 6; rocks, 475, 489, 494, 497, 504
- Specific retention, 325
- Specific yield, 325
- Sphalerite, 43
- Spit, 389
- Springs, 308, 314; artesian, 317; classification, 316; contact, 317; depression, 317; development of, 318; fissure, 317; intermittent, 316; perennial, 316; tubular, 317; yield of, 318
- Stage, geologic, 651
- Stalactites, 123
- Stalagmites, 123
- Stassfurt, Germany, 116
- Static level, 322
- Staurolite, 23
- Steatite, 25
- Stevenson, T., 381
- Stilbite, 28
- Stock, igneous rock, 55; ore deposit, 621
- Stone Mountain, Ga., 55
- Stone River limestone, 660
- Stratification, 98
- Stratum, 99
- Streak, minerals, 4
- Streams, see Rivers
- Strike, 150
- Subbituminous coal, properties, 547

- Subcapillary interstice, 323
 Subsurface water, 305; aeration zone, 309; capillary fringe, 309; composition of, 345; connate, 305; effect on dams, 349; effect on foundations, 352; effect on reservoirs, 349; effect on tunneling, 352; water table, 311; ground water, 308; magmatic, 305; meteoric, 305; movement of ground water, 310; pollution, 321; provinces, 340; rate of movement, 326; relation to glacial drift, 443; rocks yielding, 327; rock spaces for, 323; soil water, 309; springs, 308, 314; suspended, 309; water table, 308, 309. See Artesian Water, Springs
- Sudbury, Can., 42, 53
 Surface waters, see Rivers, 252
 Surveying, geologic, 162
 Swamps, 427; inland, 428; relation to engineering work, 429; relation to railroads, 429
- Sweden, 22, 607, 661
 Switzerland, 422, 426, 435
 Syenite, 77; for building, 486
 Syncline, 151
 Synclinorium, 153
 System, geologic, 651
- T
- Taconian, 656
 Talc, 25
 Tennessee, 34, 123, 144, 255, 265, 321, 349, 351, 497, 499, 567, 581, 583, 587, 629, 640, 642, 643, 658, 667, 668, 670, 671
 Tertiary system, 684
 Texas, 80, 276, 318, 329, 337, 344, 482, 485, 494, 526, 532, 552, 568, 575, 583, 594, 630, 653, 656, 663, 667, 671, 673, 675, 679, 682, 683
 Texture, rocks, 66
 Thomas, B. F., 264, 293
 Throw, of fault, 179
 Tidal wave, 392
 Tides, work of, 392
 Till, 438
 Tolman, C. F., 626
 Topography, young, 289
 Tourmaline, 23
 Trap rock, for roads, 602
 Travertine, 123
 Tremolite, in building stones, 453, 497; mineral, 18, 19
 Triassic system, 676
 Trinidad, 585
 Trinidad asphalt, 587
 Tripolite, 117
 Troctolite, 81
 Tuff, 92
 Tully limestone, 667
 Tundras, 427, 429
 Tunneling, in relation to, dikes, 51; faults, 188; folds, 159; glacial drift, 442; ground water, 352; talus slopes, 358
 Tunnels, hydration of rocks in, 233; in limestone, 121; in marbles, 144; in sandstone, 108
 Tuscaloosa series, 682
 Twinning, crystals, 2
- U
- Uintaite, 586
 Ulsterian series, 667
- Unakite, 75
 Unconformity, 203
 Underground water, see Subsurface water
 Undertow, 380
 Uplift pressure, 461a
 Uralitization, 81
 Utah, 54, 123, 254, 423, 424, 427, 562, 568, 581, 585, 587, 589, 621, 634, 638, 656, 663, 675, 679, 691
 Utica shales, 660
- V
- Vadose water, 309
 Valley train, 439
 Valleys, river, 287
 Van Hise, C. R., 129, 212, 233, 237, 325, 610, 622
 Veins, 618; bedded, 620; conjugate, 620; material, 618; ore, 618; system, 620
 Verde antique, 145
 Vermont, 26, 135, 144, 463, 468, 483, 497, 499, 500, 503, 504, 505, 640, 659, 661
 Vesicular, 69
 Virginia, 26, 34, 116, 117, 130, 145, 147, 240, 255, 267, 318, 321, 334, 337, 351, 428, 483, 504, 505, 522, 524, 525, 552, 560, 562, 567, 568, 570, 621, 629, 633, 640, 642, 643, 658, 661, 668, 670, 671, 677, 679, 685
 Vitrophyre, 90
 Volcanic ash, 92
 Volcanic rock, 56; for building, 486; for roads, 602; fragmental, 92
- W
- Wales, 658
 Warsaw beds, 670
 Washington, 144, 147, 349, 364, 444, 464, 480, 497, 500, 560, 568, 573
 Water, artesian, 321; connate, 305; hardness, 347; in crystalline rocks, 332; in glacial drift, 330; in lava flows, 59; in sedimentary rocks, 327; juvenile, 610; magmatic, 610; meteoric, 305; ore deposition by, 610; potable, 347
 Water falls, 272
 Water power, relation to glaciation, 446
 See Rivers, Lakes, Subsurface waters, Swamps, Glaciers, Artesian Water
 Water table, 309, 311, 314; perched, 314; relation to reservoirs, 448a
 Water-yielding, capacity, rocks, 325
 Watson, T. L., 459
 Waucoban, 656
 Waves, cause of, 377; beaches, 385; cutting, 383; depth of disturbance, 378; dimensions of, 378; erosion by, 380; force of, 381; oscillatory, 377; terraces, 383; translatory, 377; undertow, 380; velocity of, 379; vertical range, 382
 Weathering, carbonation, 236; defined, 224; dehydration, 233; deoxidation, 236; disintegration, 224; hydration, 232; loss in, 240; of different rocks, 244; ore deposits, 622; oxidation, 233; processes, 224; rocks, 223; solution, 237; structures affecting, 242
 Wehrlite, 84
 Wells, drainage by, 319, 320
 Wells, see Artesian
 West Virginia, 505, 552, 567, 589, 570, 584, 585, 586, 668, 670, 671, 673, 675

- | | | |
|---|--|---|
| White, D., 562, 580 | | |
| Wind deposits, 111 | | |
| Wisconsin, 130, 255, 320, 341, 349, 418, 426, 459,
469, 482, 485, 489, 494, 514, 521, 532, 536, 608,
633, 643, 656, 661 | | |
| Wurtzilite, 585 | | |
| Wyoming, 79, 82, 89, 90, 93, 123, 254, 526, 568,
581, 607, 620, 633, 634, 654, 661, 671, 675,
679 | | |
| | | Y |
| | Yale bowl, 227 | |
| | Yellowstone Park, 30, 123 | |
| | Yosemite, 55 | |
| | | Z |
| | Zeolites, 28 | |
| | Zinc ores, classification, 641; mode of occurrence,
642; ore minerals, 640; weathering, 641 | |

