

UNIVERSAL
LIBRARY

OU_191106

UNIVERSAL
LIBRARY



مجموع اشكال
رياض المختار
مرآة المقات والادوار

تأليف

الجبر الزمار ومشيده دعائم الماتر والاشمار
ومجهد عالم السلام في هذه الاعصار صاحب الدولة

العازي أحمد باشا مختار

ترجمته

من التركيبة الى العربية

حضرة شقيق بك منصور

(ين)

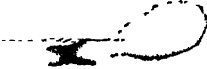

(الطبعة الاولى)

المطبعة الكبرى الاميرية بيوتان مصر المحمية

سنة ١٣٠٦

هجريه



زيتنا المخبيا

مرآة المبتقات والادوار

تأليف

الغازي احمد مختار ناشا

طُبِعَ مَطْبَعَةُ تَحْسِينِ حَبْرِي فَنَدِي الرِّسَامِ بِمَكْرُوَسْتِهْ ص ٢٠

فِي ١٣٠٣ هـ

شكل ١

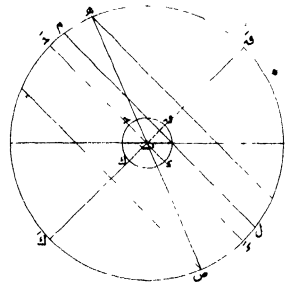

شكل ٢

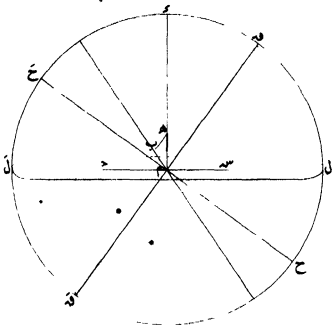

شكل ٣

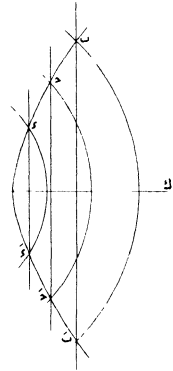

شكل ٤

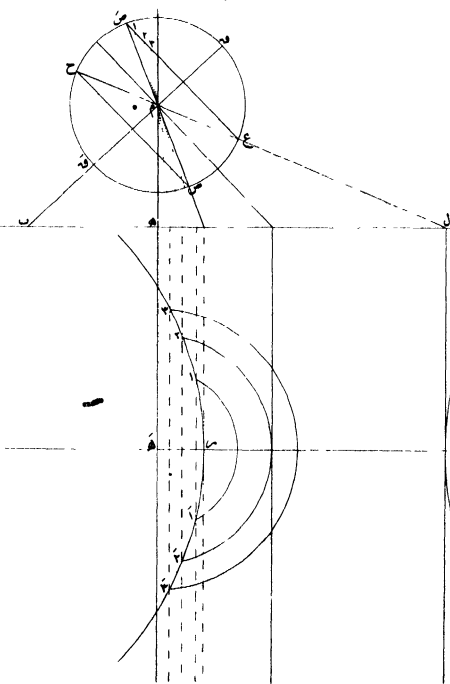

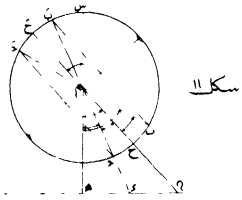
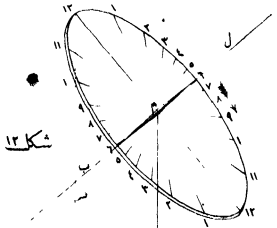
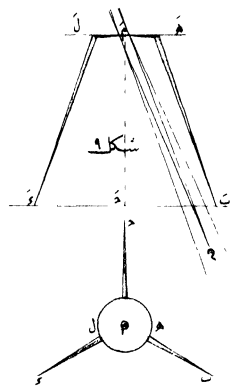
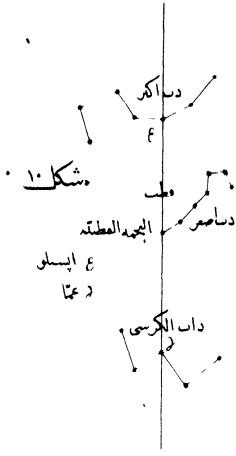

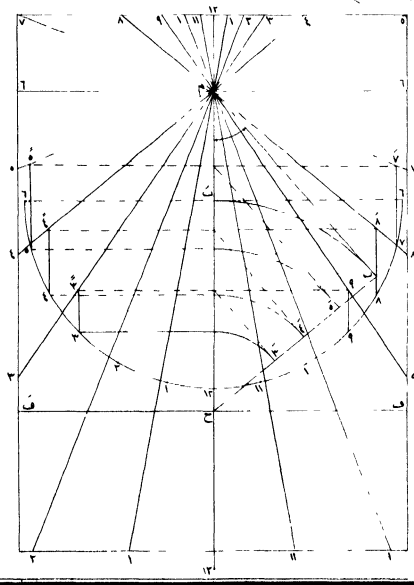
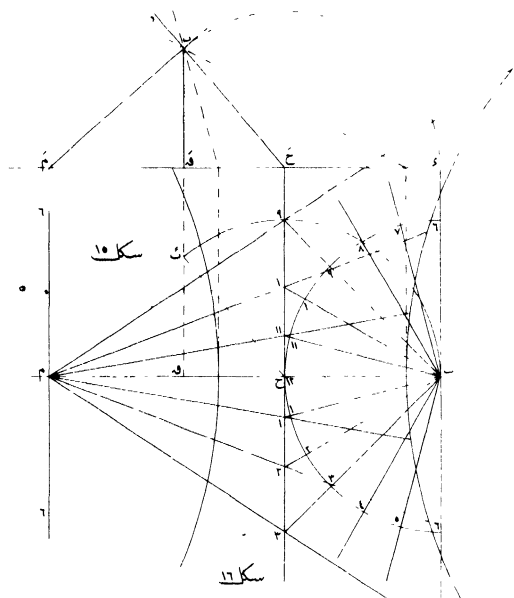

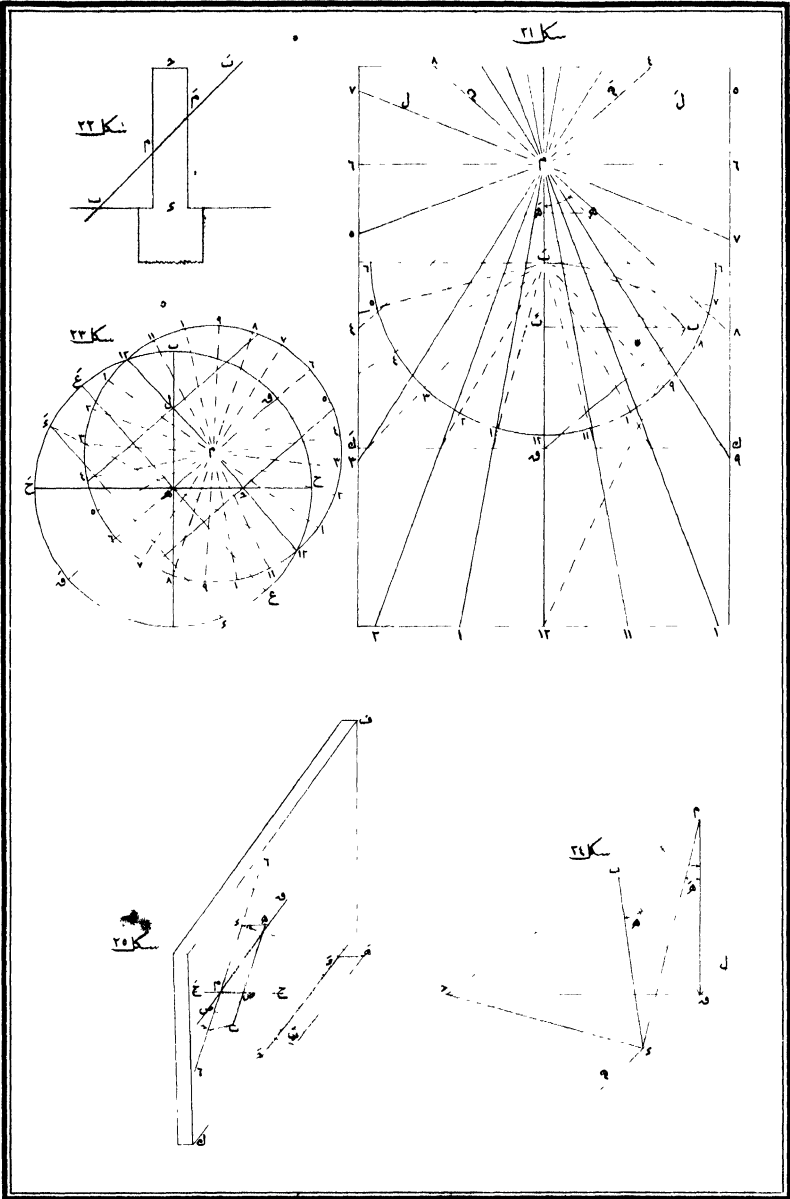

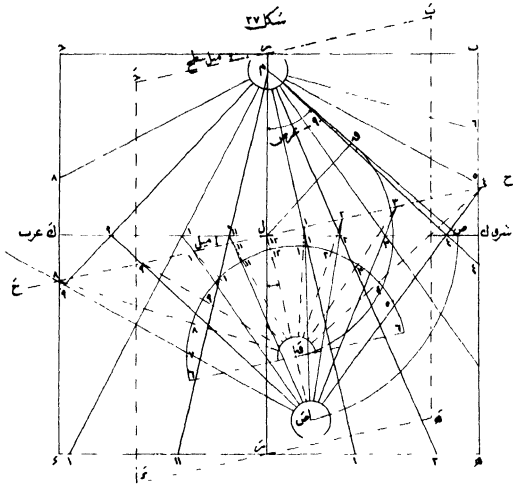
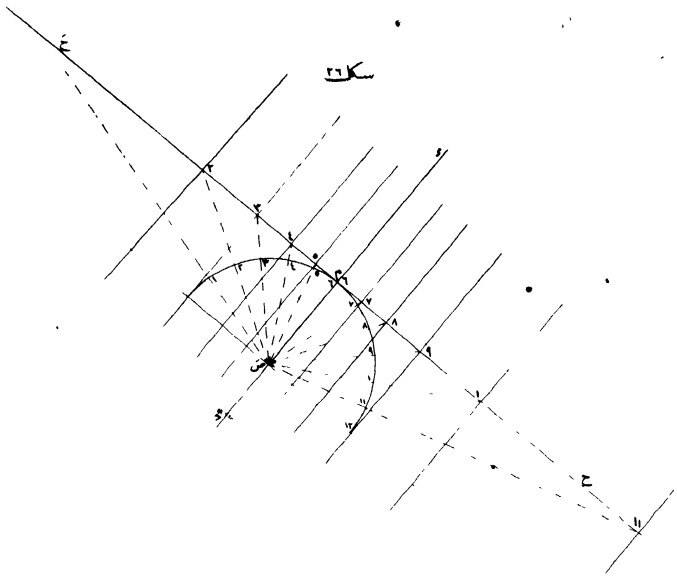

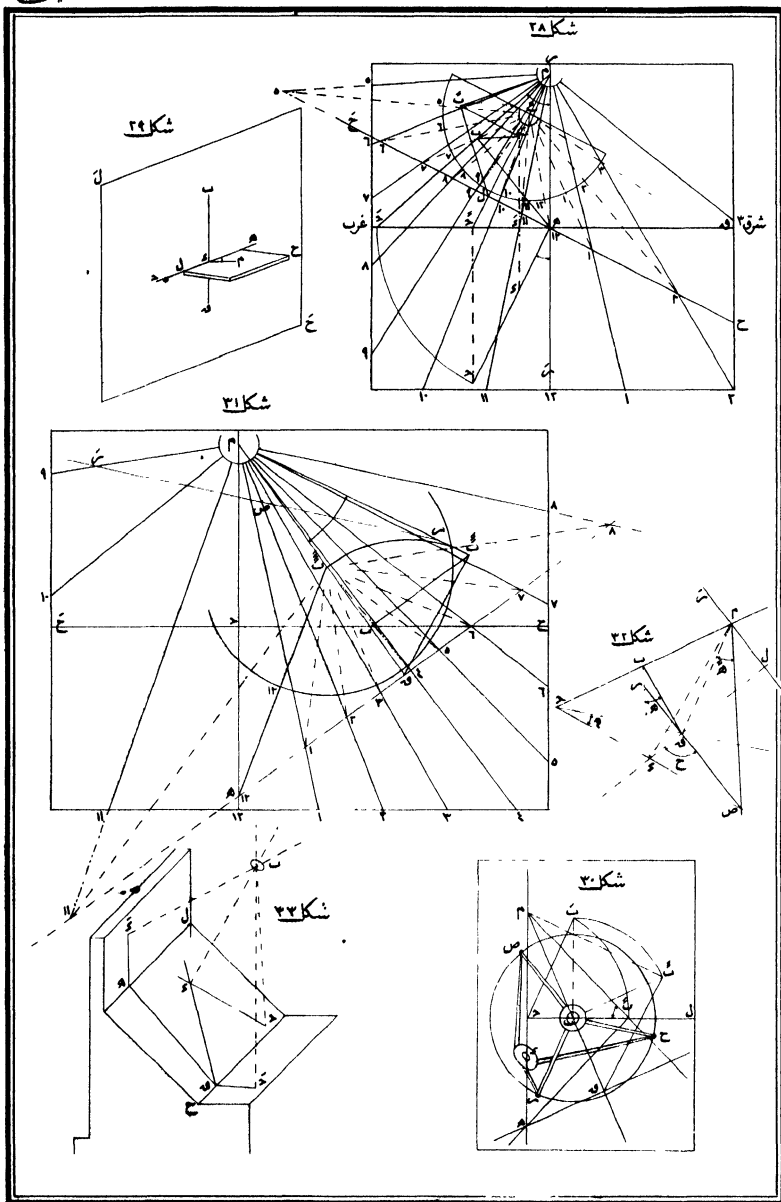

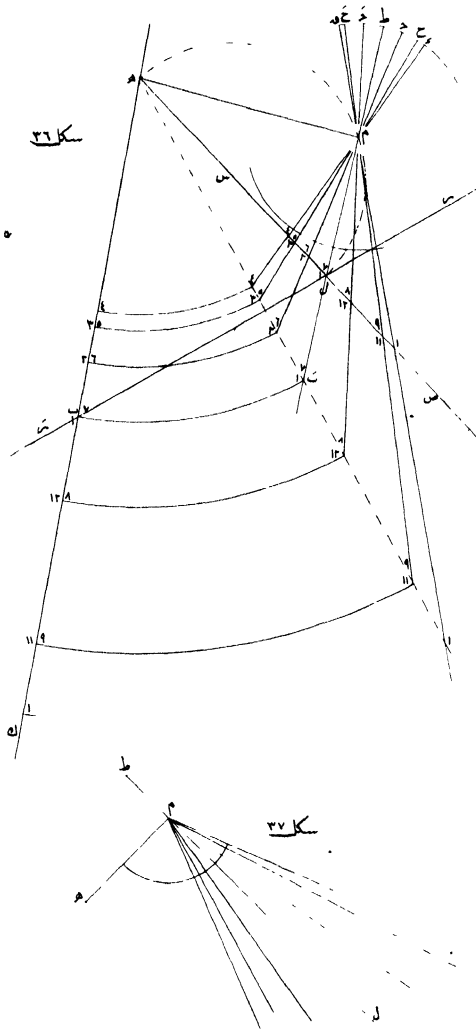

شكلا ٤٦

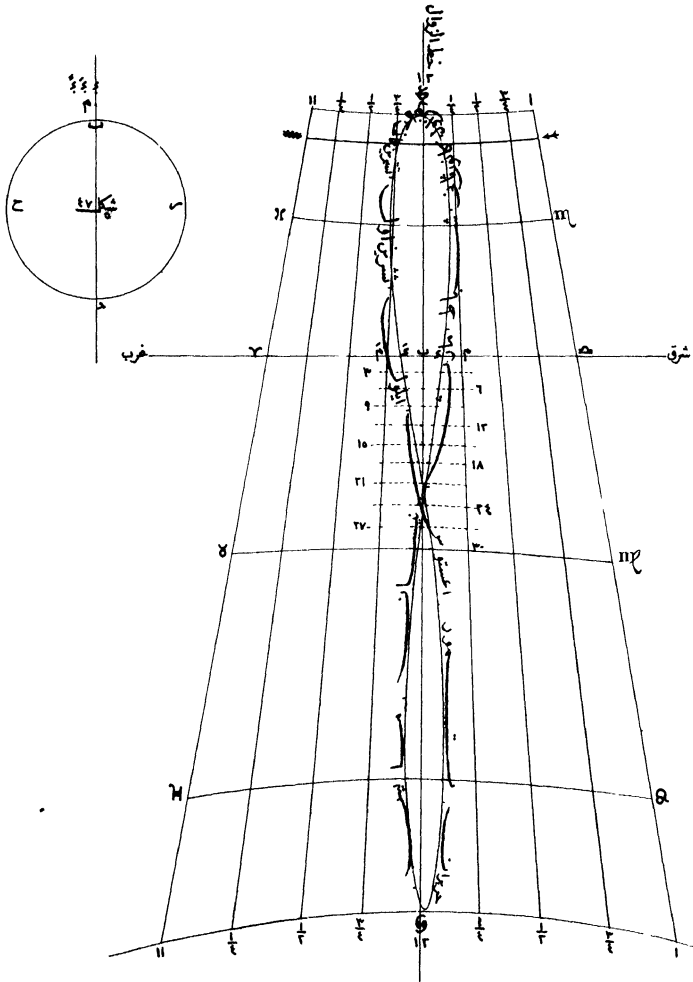

شكلا ٤٨

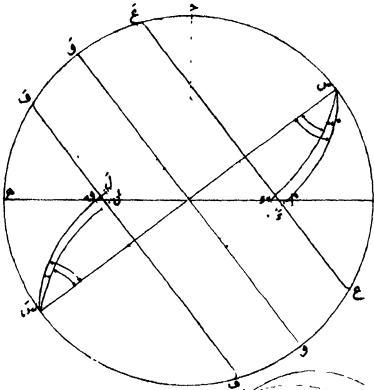

شكلا ٤٩

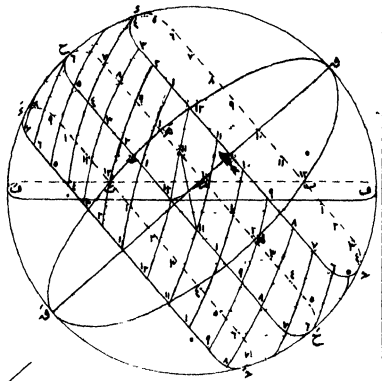

شكلا ٥٠

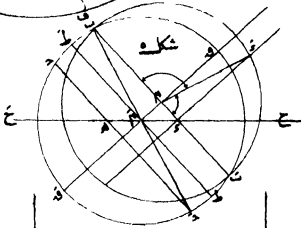

شكلا ٥١

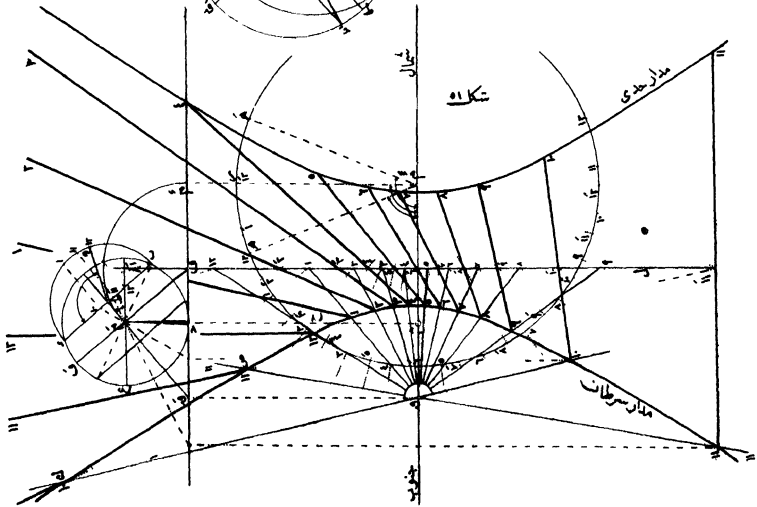

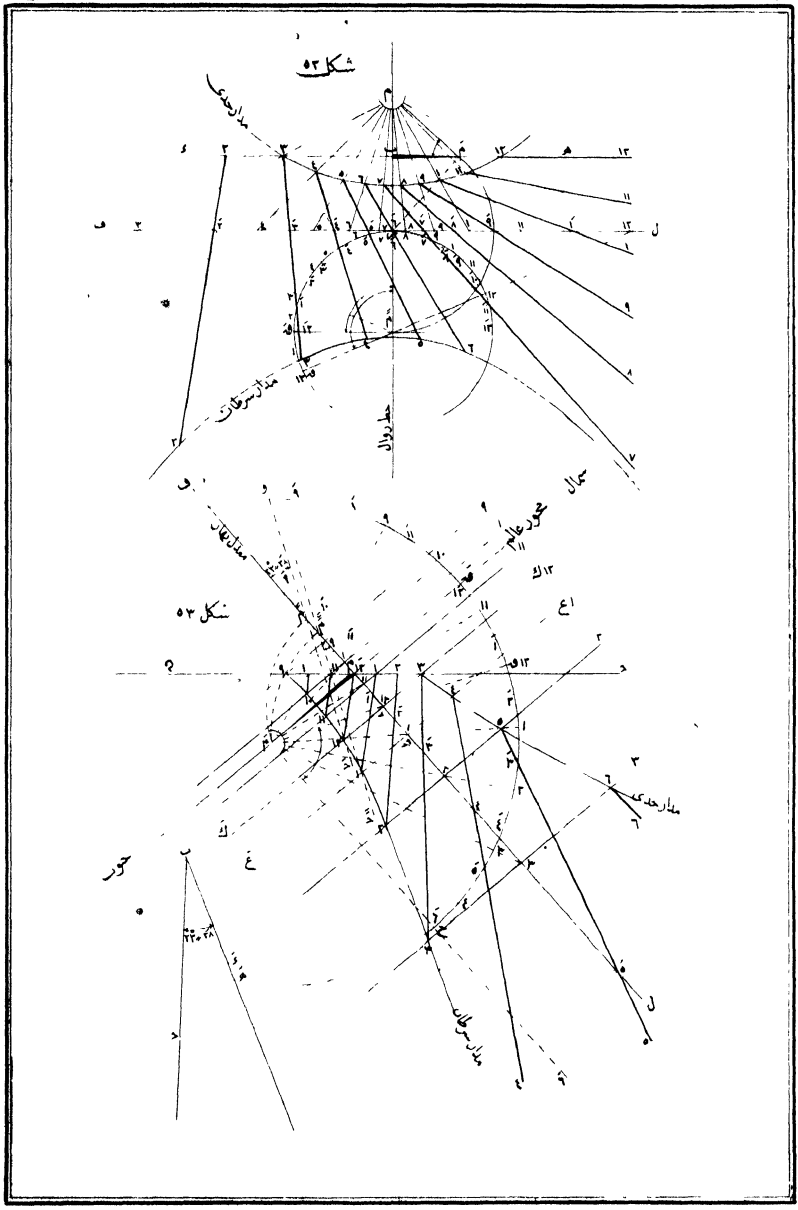

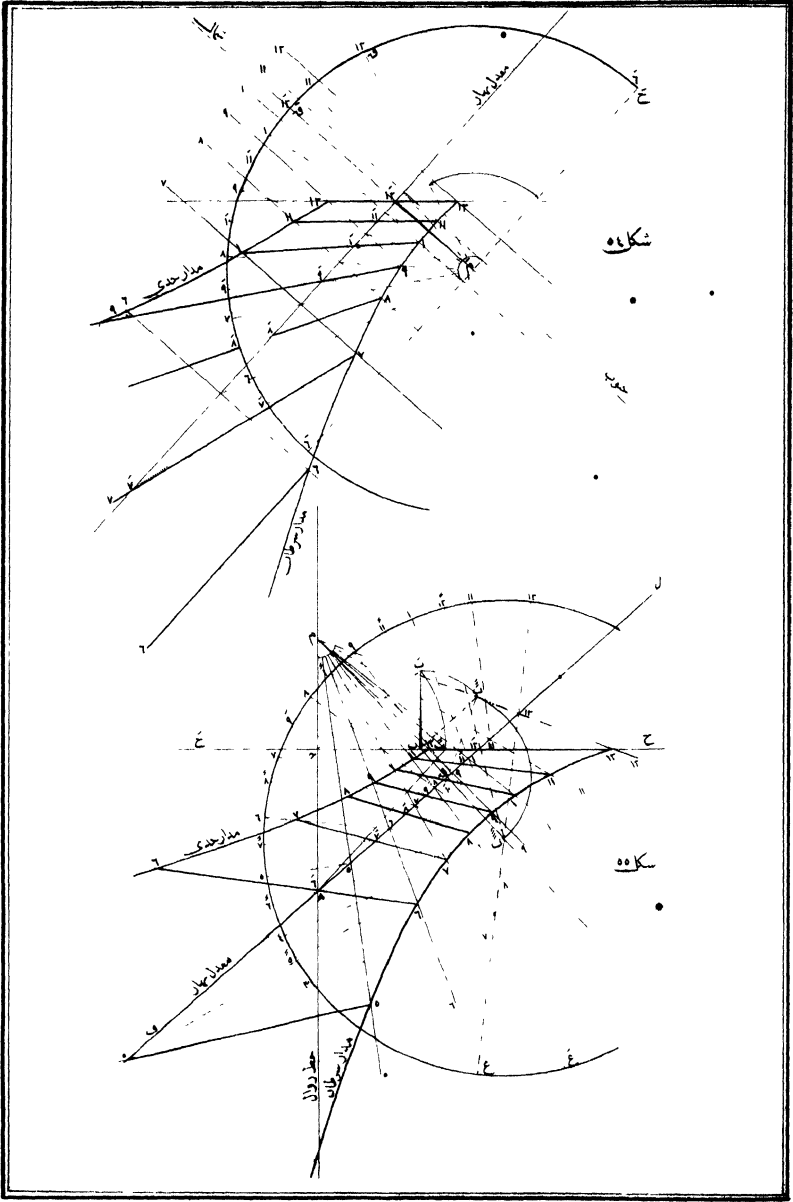

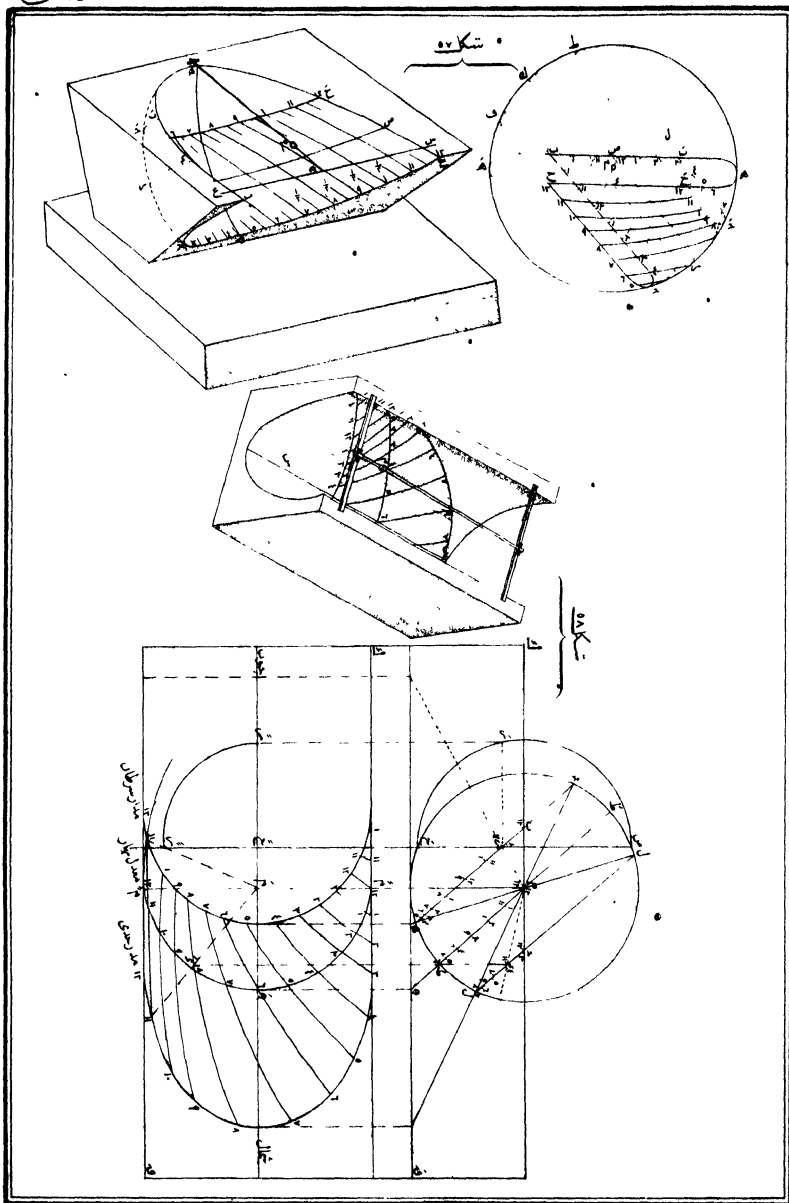

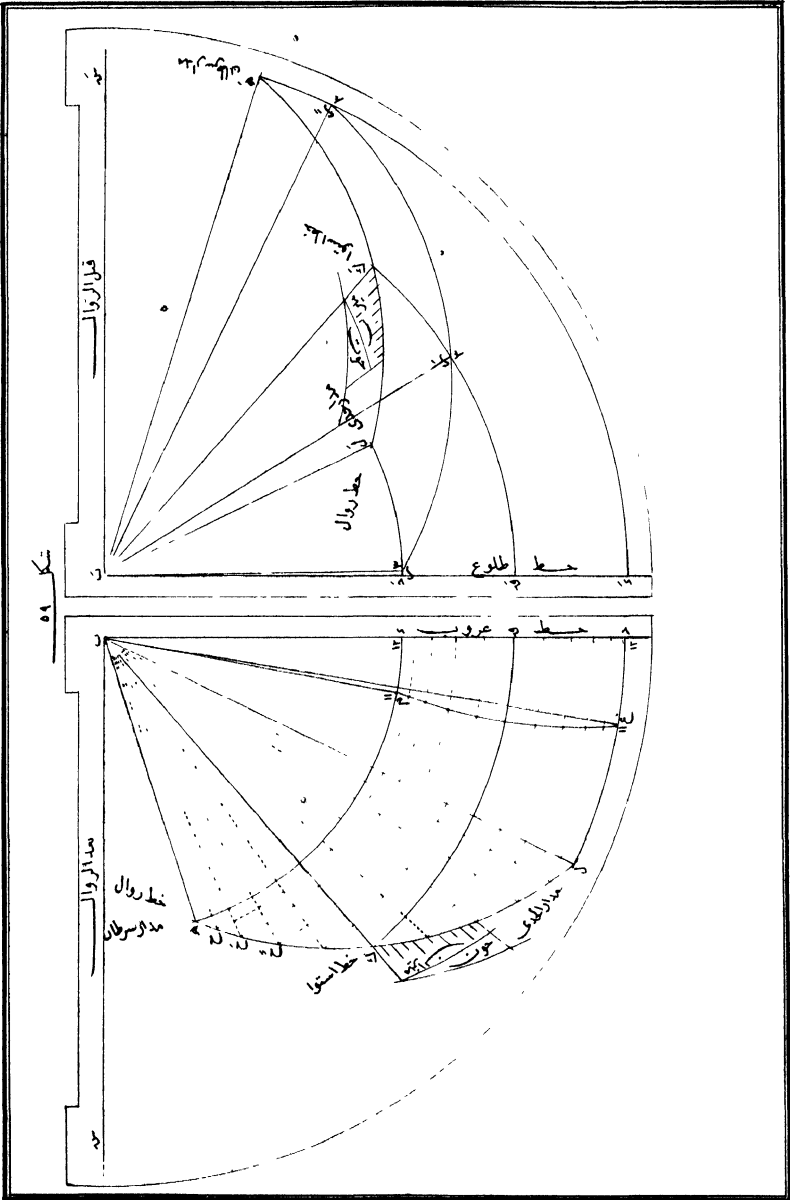

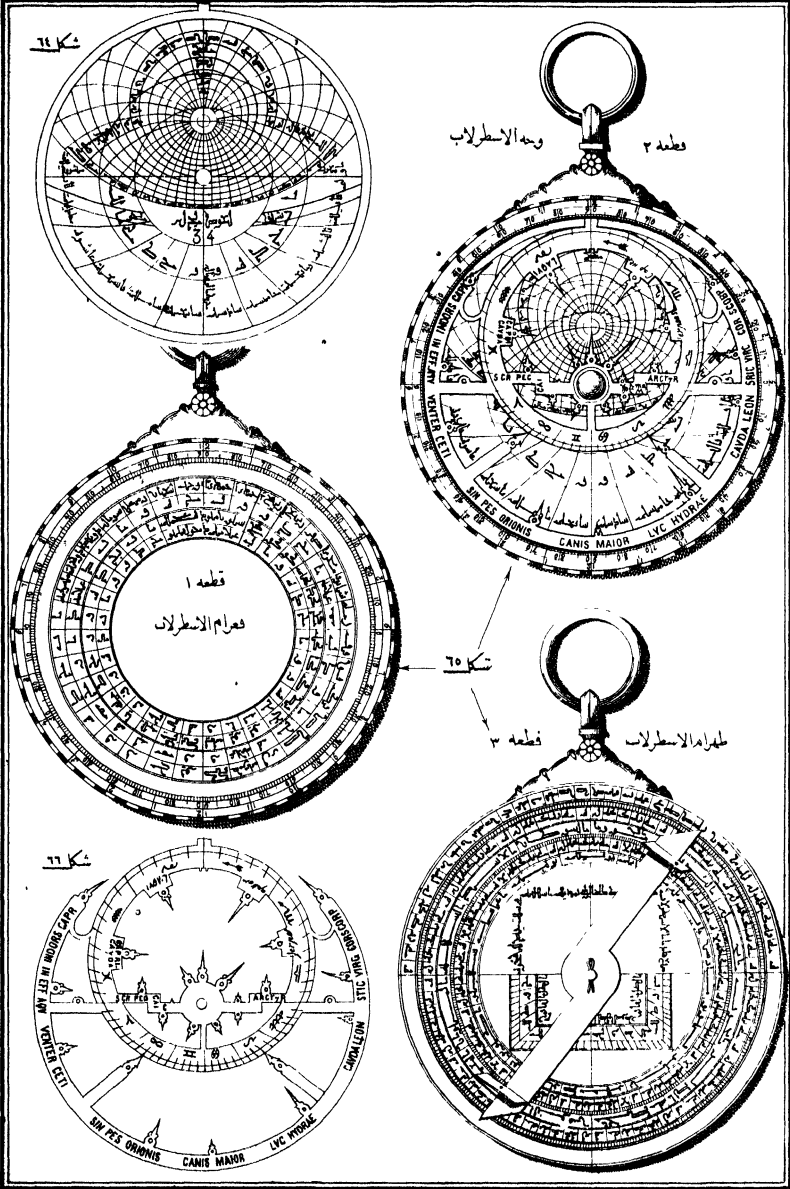

مصدره بولدنيهم اسطرلابك وجيديد



اسطرلاب مذكورك ظهره يدور

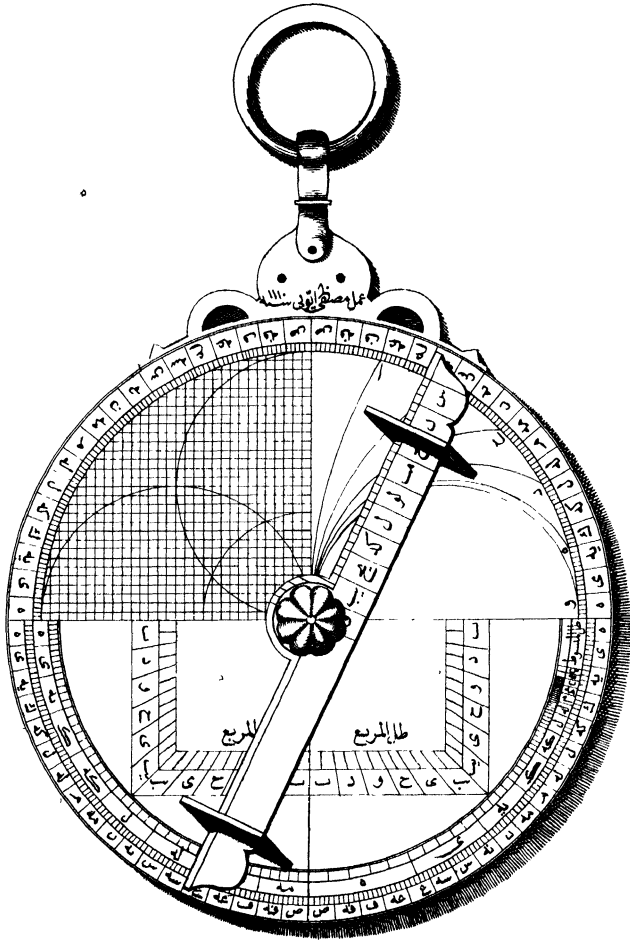

شك ٦٧

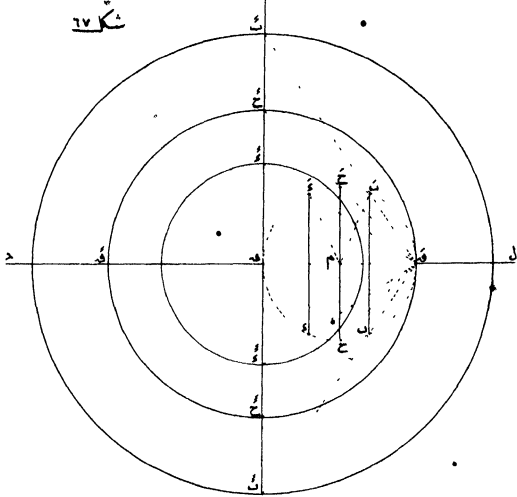

شك ٦٨

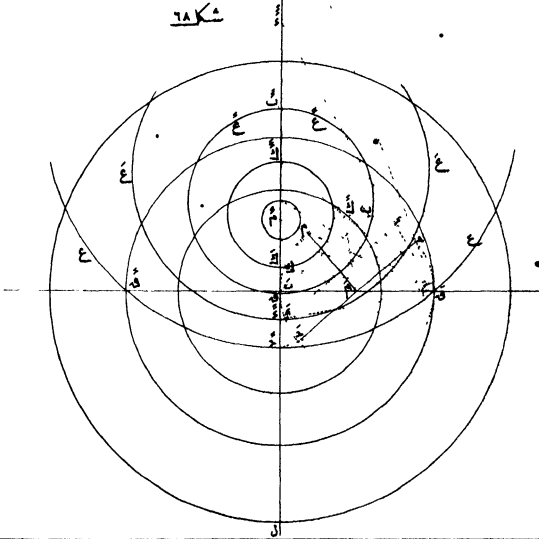

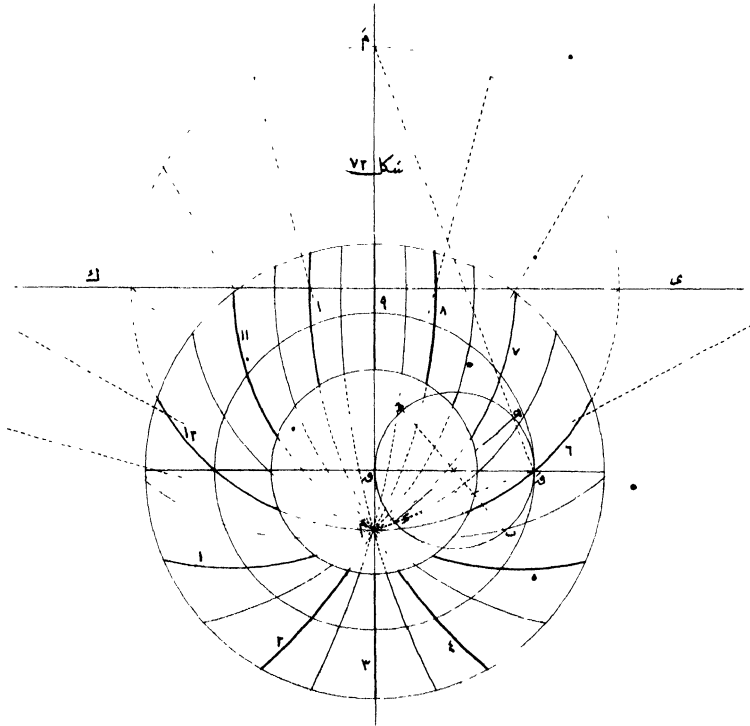
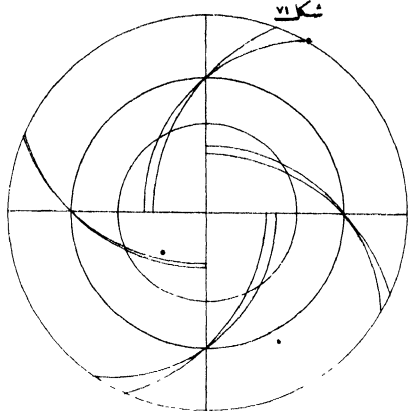

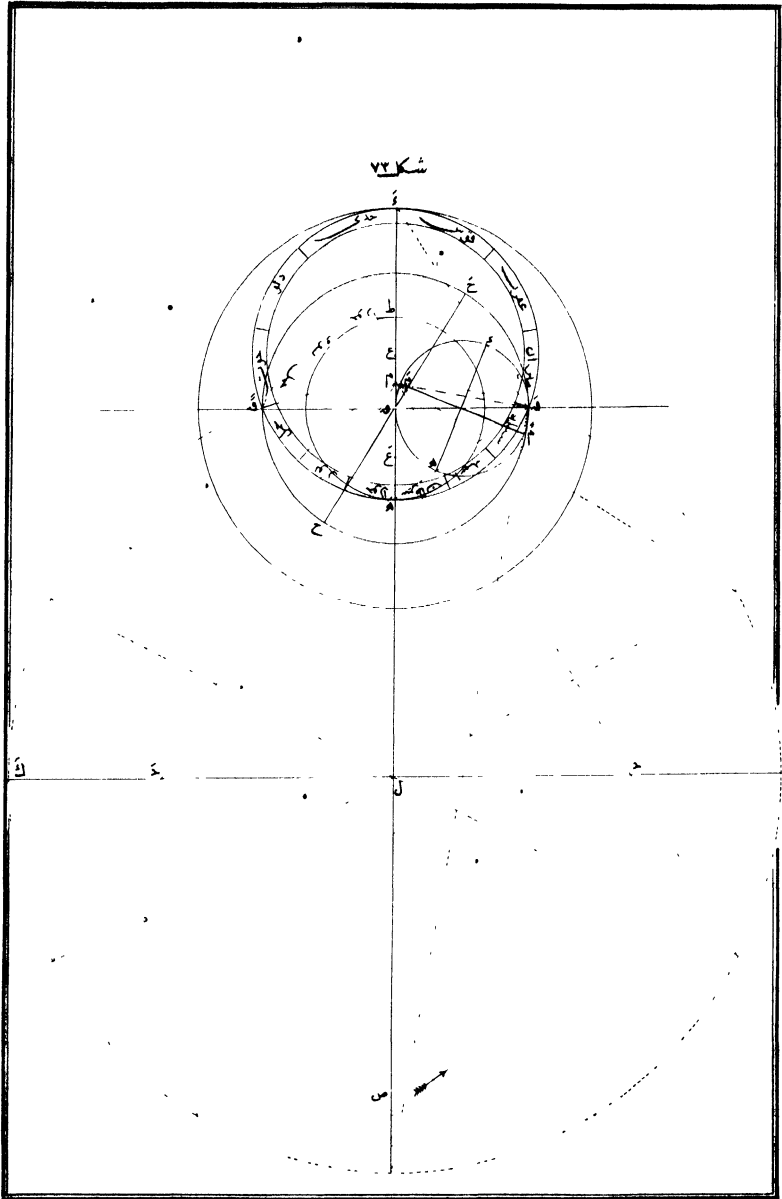

شكلا ٧٤

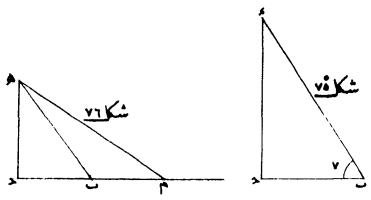
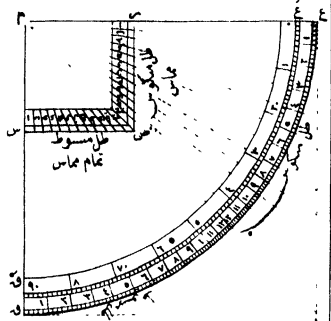

شكلا ٧٨

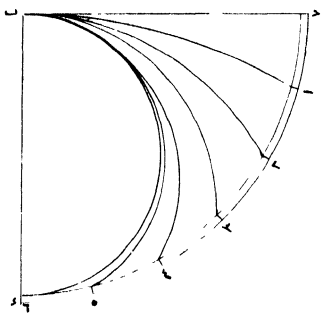

شكلا ٧٧

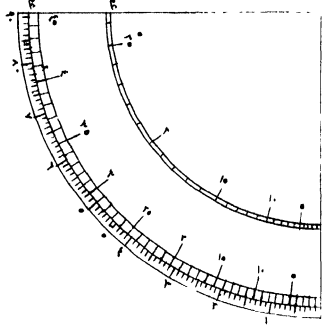

شكلا ٨

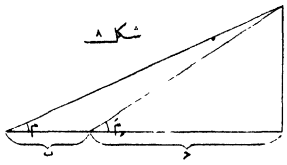

شكلا ٧٩

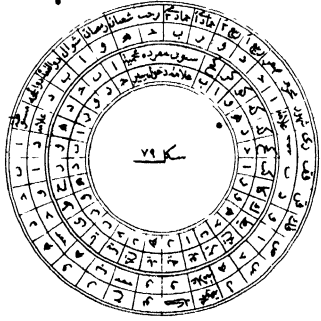

شكلا ١٤ ربع الخشب المبخار

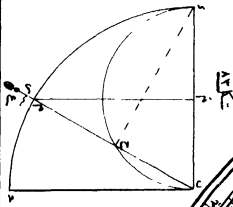
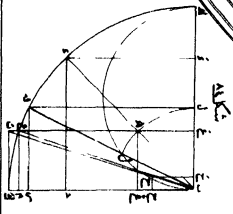
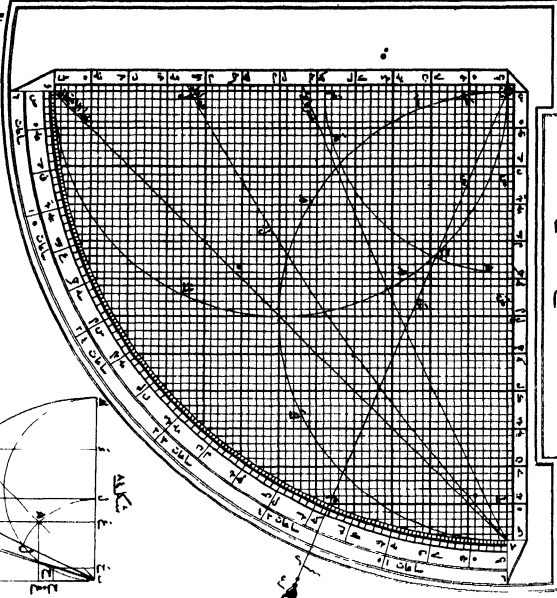

شكلا ١٥ ربع الخشب المبخار

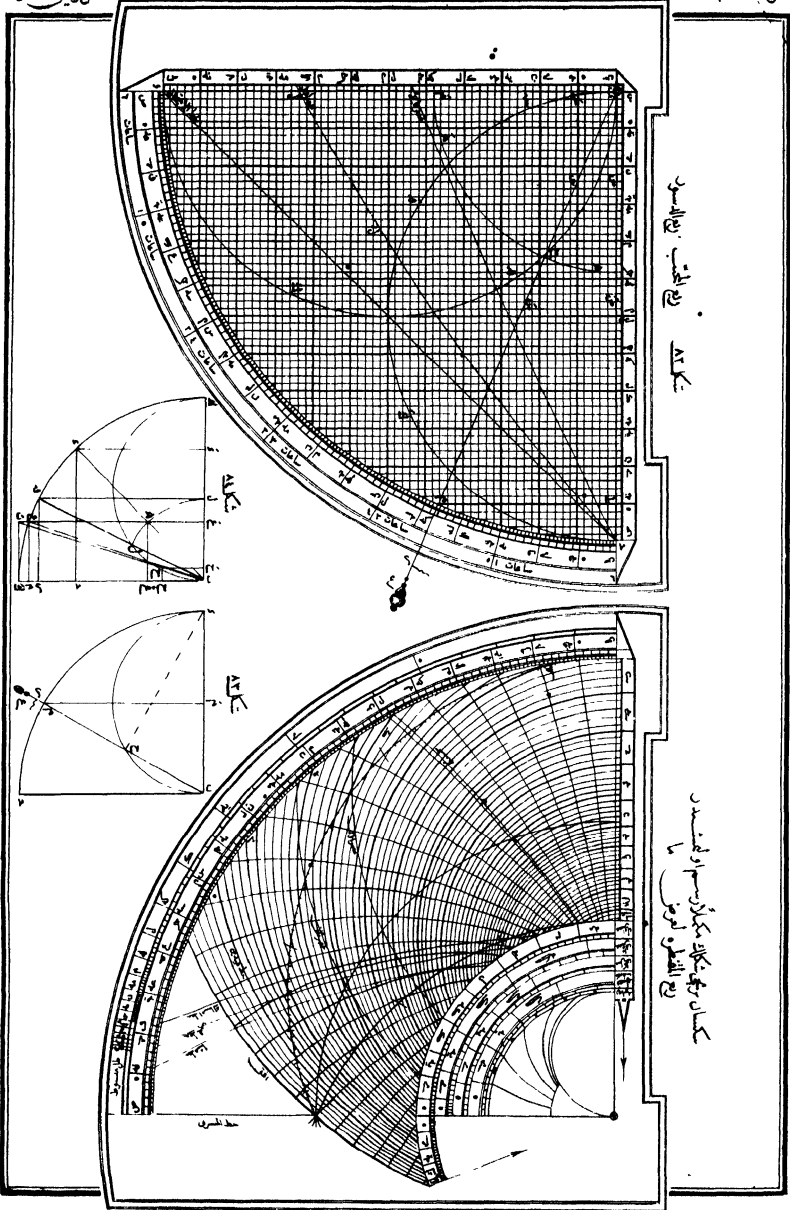
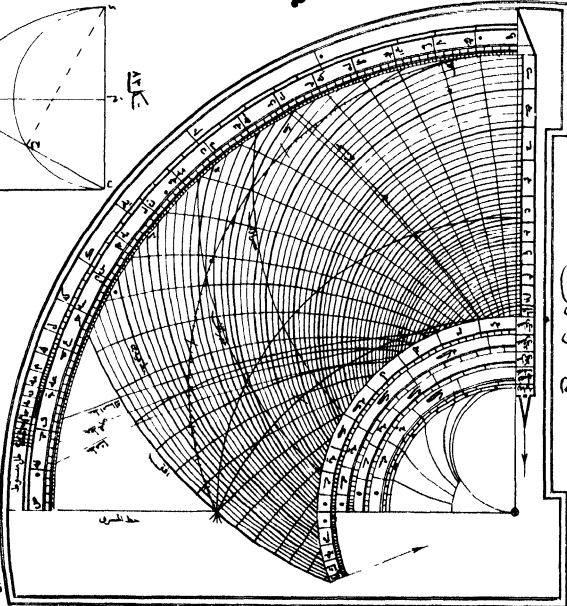

شكلا ١٠

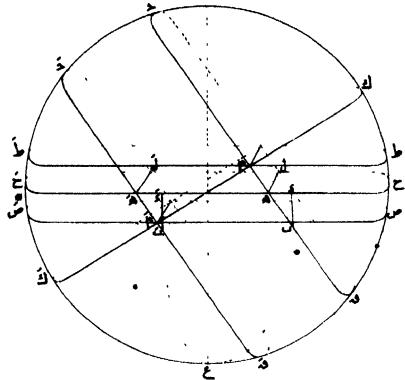

شكلا ١١

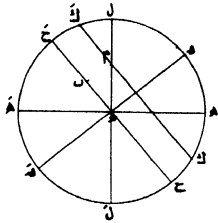

شكلا ١٢

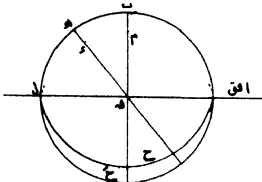

شكلا ١٣

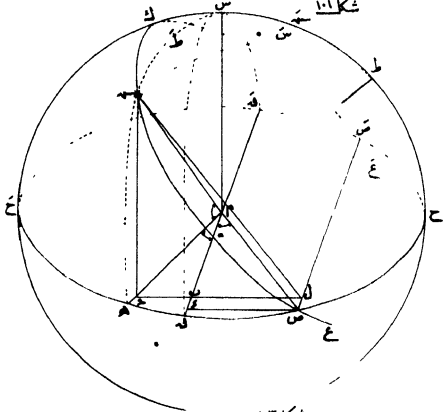

شكلا ١٤

