

UNIVERSAL  
LIBRARY

**OU\_218801**

UNIVERSAL  
LIBRARY



OSMANIA UNIVERSITY LIBRARY

Call . 913.945  
M11E V3 s s i o n . N o . 6786

Author

Title

This book should be returned on or before the date last marked below





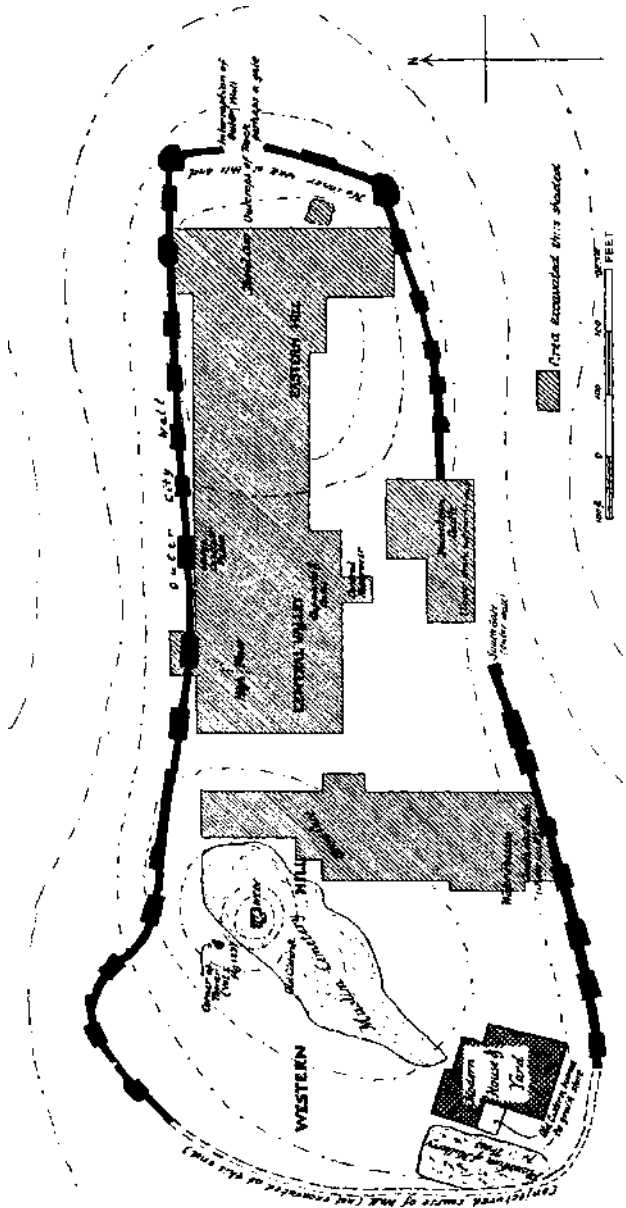

**THE  
EXCAVATION OF GEZEF**

**1902—1905 AND 1907—1909**

**BY R. A. STEWART MACALISTER**

**M.A., F.S.A.,**  
PROFESSOR OF CELTIC ARCHAEOLOGY, UNIVERSITY COLLEGE, DUBLIN

WITH NUMEROUS ILLUSTRATIONS

IN TWO VOLUMES OF LETTERPRESS AND  
ONE VOLUME OF ILLUSTRATIONS

VOL. III

TWO HUNDRED AND TWENTY-SIX PLATES  
WITH INDEX

PUBLISHED FOR THE COMMITTEE OF THE PALESTINE EXPLORATION FUND

BY  
JOHN MURRAY, ALBEMARLE STREET, LONDON, W.

1912

ALL RIGHTS RESERVED

*Printed by Hazel I. Watson & Viney, Ltd., London and Aylesbury.*

## INDEX TO PLATES

\*\*\* The reference following the titles of the plates will help the reader to find the volume and page where the description of the objects illustrated will be found. Additional particulars elsewhere in the book regarding individual figures on the plate are referred to in the line below the title, in the form "17 (I. 126)," which means "for fig. 17 see vol. I. p. 126."

### PLATB

#### *Frontispiece*

KEY PLAN OF THE EXCAVATION

### I-VII

PLANS OF THE SUCCESSIVE STRATA OF BUILDINGS, WITH THE THREE INTER-MEDIATE STRATA ON THE WESTERN HILL (I. 158-167)

For the references on the plans see the list at the end of this Index.

### VIII

PLAN OF THE SURROUNDINGS OF GEZER  
For sites and objects marked on this plan see the appropriate headings in the General Index.

### IX

1. HILLS SOUTH OF GEZER (I. 2)
2. THE "HAJAR IBRAHIM" (I. 5, II. 50)

### X, XI

BOUNDARY INSCRIPTIONS (I. 37-39)  
xi 3 (I. 40)

### XII

MODERN FELLAHIN OF THE DISTRICT (I. 64)

### XIII

CAVE PLANS

- 1 (I. 109), 2 (I. 269), 3 (I. 271), 4 (I. 107),  
5 (I. 270), 6 (I. 93), 7 (I. 76), 8 (I. 96),  
9 (I. 109), 10 (I. 103), 11 (I. 143)

### XIV

CAVE PLANS

- 1 (I. 82), 2 (I. 83), 3 (I. 84), 4-6 (I. 85)  
7, 8 (I. 99), 9 (I. 86), 10 (I. 142), 11  
(I. 143), rock surface (I. 86)

### PLATB

#### XV

DETAILS OF CAVE 2 I [THE CREMATORIUM]  
(I. 74, 76)

#### XVI

CAVE 3 III AND ITS CONTENTS (I. 77, 78,  
II. 153), 9 (II. 149)

#### XVII

ROCK-SCARP WITH CUP-MARKS [ASSOCIATED WITH CAVE 4 I] (I. 78)

#### XVIII

CONTENTS OF CAVE 8 I (I. 81, 82 \*)  
20 (II. 166)

#### XIX

- 1-9. CONTENTS OF CAVE II II (I. 84,  
II. 153)  
10-24. CONTENTS OF WATER-PASSAGE  
(I. 264, 265)  
25-28. CONTENTS OF CISTERN EAST OF  
TOMB NO. 11 (I. 273)  
5 (II. 133), 9 (II. 150), 15 (II. 343)

#### XX-XXII

CONTENTS OF CAVE 15 I (I. 89-93, II. 176)  
xxii 5 (II. 135)

#### XXIII

- 1-17. CONTENTS OF CAVE 15 I (*continued*)  
18-21. CONTENTS OF CAVE 30 I I a (I. 143)  
22. PECULIAR LEDGE-HANDLE (II. 144)

#### XXIV

CONTENTS OF CISTERN IN CAVE 15 II  
(I. 94-96)

#### XXV, XXVI

CAVE 15 IV AND ITS CONTENTS (I. 96-98)  
xxvi 2 (II. 70), xxvi 9, 10 (II. 314)

\* In vol. I. p. 82, line 12, *fc* "bracket" read "bucket."

- PLATE  
 XXVII  
 ROCK-SURFACE WITH CUPS AND CAVES  
 (I. 100-103)
- XXVIII  
 CONTENTS OF CAVE 27 I (I. no)  
 1-3 (II. 370). 9 (II. 184), 20 (II. 449)
- XXIX  
 1, 2. CONTENTS OF CAVE 27 I (*continued*)  
 3-7. CONTENTS OF CAVE 30 III (I. 143)  
 1 (II. 159)
- XXX  
 DETAILS OF CAVE 28 II (I. 111-115)
- XXXI  
 OBJECTS FROM CHAMBER (2),\* CAVE 28  
 II (I. 120)  
 1 (II. 260), 2 (I. 127), 3 (I. 129), 4-27  
 (II. 314), 4-8 (I. 129), 11-14 (I. 126),  
 13 (II. 450), 15 (I. 127), 16, 17 (I. 126),  
 18 (I. 129), 19 (I. 119), 20, 23 (II. 260),  
 24 (I. 127), 25 (I. 126, II. 450), 27 (I.  
 120, 129), 30 (I. 129)
- XXXII  
 POTTERY, ETC., FROM (2, 3, 4) \* CAVE 28  
 II (I. 129, 130)  
 1 (120), 6 (I. 119, 124), 8-24 (I. 120)
- XXXIII  
 POTTERY FROM THE CISTERN IN CHAMBER  
 (2), CAVE 28 II (I. 120, 130)
- XXXIV  
 IVORY, ETC., FROM CAVE 28 II (I. 122-  
 125; *see also* II. 247, 248)  
 13 (II. 243)
- XXXV  
 SCARABS, ETC., FROM CAVE 28 II (I. 123,  
 126-129, 141, II. 314)
- XXXVI  
 POTTERY, ETC., FROM CAVE 28 II (I. 122-  
 126, 129, 130)
- XXXVII-XLI  
 POTTERY [FROM CAVE 28 II] (I. 122, 123,  
 126, 130-135. II. 176)
- XLII  
 ALABASTER [FROM CAVE 28 II] (I. 125, 135,  
 II. 339)
- XLIII  
 LATER OBJECTS [FROM CAVE 28 II] (I. 136)  
 1 (I. 120), 3 (II. 198)
- XLIV  
 1-6. CONTENTS OF CAVE 30 II (I. 143)  
 7-10. CONTENTS OF CISTERN, S. END  
 OF TRENCH 30 (I. 271)
- PLATE  
 XLIV—*continued*.  
 n-17. CONTENTS OF CISTERN IN CAVE  
 14 I (185. 86)  
 14, 15 (II. 329)
- XLV  
 INTERIOR OF CAVE 30 IV SHEWING POSI-  
 TIONS OF GRAFFITI (I. 145)
- XLVI, XLVII  
 GRAFFITI IN CAVE 30 IV (I. 146-152)
- XLVIII  
 GRAFFITI IN CAVE 30 IV (*continued*) AND  
 PLAN OF THE CAVE  
 OBJECTS FROM CAVES 6 I AND 7 II (I. 80)
- XLIX  
 HOUSE PLANS (I. 169-173)  
 7 (I. 175) 8, 9 (I. 201)
- L  
 ROMAN BATH, YERDEH (I. 228-236)
- LI  
 PLAN OF THE NORTH-EAST GATE (I. 240)
- LII  
 THE WATER-PASSAGE (I. 256-264)
- LIII  
 FRAGMENTS OF MOULDINGS [FOUND IN  
 THE CENTRAL RESERVOIR] (I. 267)
- LIV  
 RESERVOIR (I. 274)
- LV  
 PHILISTINE TOMB DEPOSITS (I. 292)  
 1, 2 (II. 339)
- LVI  
 TOMB PLANS  
 1 (I. 301), 2 (I. 304), 3-6 (I. 309), 7 (I.  
 304), 8 (I. 309), 9-11 (I. 310), 12 (I.  
 311), 13 (I. 312), 14 (I. 317), 15 (I- 320),  
 16 (I. 321), 17 (I. 325), 18 (I. 353)
- LVII  
 TOMB PLANS  
 1 (I. 368), 2, (I. 380), 3 (I. 353), 4 (I-  
 364), 5 (I. 365), 6 (I. 359), 7, 8 (I. 358),  
 9 (I. 359), 10 (I. 344), 11 (I. 346), 12 (I.  
 345), 13 (I. 343), 14 (I. 338), graffiti  
 (I. 365)
- LVIII  
 TOMB PLANS  
 1 (I. 381), 2, 3 (I. 379), 4, 5 (I. 377), 6,  
 7 (I. 376), 8 (I. 348), 9 (I. 381), 10, 11  
 (I. 374), 12, 13 (I. 348), 14 (I. 347), 15  
 (I. 366), 16 (I. 359, 361), 17 (I. 370)

<sup>1</sup> Substitute these reference-figures for the letters in the plate-headings.

## Index to Plates

### PLATE

- LIX  
TOMB PLANS  
I (1.384), 2 (1.373), 3 (1.370), 4 (I.315,316),  
5, 6 (I. 334), 7 (I. 372), 8 (I. 336), 9  
(I. 344, 345), 10 (I. 346), 11 (I. 387),  
12 (I. **311**), 13 (I. 312), 14 (I. 340), 15  
(I. 350), 16 (I. 385)
- LX-LXIII  
[DEPOSITS IN] TOMB NO. I (I. 301, 302,  
II. 176)  
Ixxiii 79, 80 (II, 314)
- LXIV-LXVIII  
[DEPOSITS IN] TOMB NO. 7 (I. 305-307,  
II. 156, 194)  
Ixxvi 42 (II. 306) Ixxvii 1 (II. 156), 3 (II. 198)
- LXIX  
TOMB NO. 8 [PLAN AND DEPOSITS] (I. 307)  
14, 15 (II. 88)
- LXX, LXXI  
TOMB NO. 9 [PLAN AND DEPOSITS] (I.  
308, II. 156, 194)
- LXXII  
TOMB DEPOSITS : 1-12, No. **18** (I. 310) ;  
13-20, No. **23** (I. 311); 21, 22, No.  
**21** (I. 311); 23, No. 77 (I. 333)  
11 (II. 227), 18-20 (II. 240)
- LXXIII  
[DEPOSITS IN] TOMB No. **28** (I. 312, II.  
**211**).
- LXXIV, LXXV  
[DEPOSITS IN] TOMB NO. **30** (I. 312-314,  
II. 194)  
Ixxiv 3 (II. 177), Ixxv 15 (II. 351), 16  
(II. 347)
- LXXVI  
TOMB NO. **31** [PLAN AND DEPOSITS] (I.  
314, 315, II. 211)
- LXXVII  
TOMBS NO. **36**, **228** (I. 316, 386)
- LXXVIII  
TOMB DEPOSITS : 1-46, No. **40** (I. 317);  
47-49, No. **104** (I. 343); 50, 51 No.  
**122** (I. 345) 14 (II. 298), 25 (II. 459),  
26 (II. 304), 38 (II. 87)
- LXXIX  
TOMB DEPOSITS: 1-4, No. **44** (I. 319);  
5-27, No. **42** (I. 318, 319, II. 153) ;  
28-31, No. **46** (I. 319); 32-35, No. **53**  
(I. 320); 36, No. **56** (I. 320); 37, 38,  
No. **125** a (I. 347); 39, *40*, *NO.* 182  
(I. 373)  
**22** (II. 140, 24, 28 (II. 221), 30, 31, 37  
(II. 240)

### PLATS

- LXXX  
[DEPOSITS IN] TOMB NO. **56** (I. 320)
- LXXXI-LXXXIII  
[DEPOSITS IN] TOMB NO. **58** (I. 321-324,  
II. 194)  
Ixxxii 2 a (II. 180)
- LXXXIV, LXXXV  
[DEPOSITS IN] TOMB NO. **59** (I. 325-331)  
Ixxxiv. 24 (II. 118)
- LXXXVI  
[DEPOSITS IN] TOMBS NO. **65-73** (I. 332)  
Ivory pin (II. 288)
- LXXXVII-LXXXIX  
[DEPOSITS IN] TOMBS NO. **84**, **85** (I. 334,  
335, II. 211)
- XC, XCI  
[DEPOSITS IN] TOMB NO. **96** (I. 337, II.  
**201**, **211**)
- XCII, XCIII  
[DEPOSITS IN] TOMB NO. **99** (I. 338, 339,  
II. 227)  
xciii 11 (II. 454)
- XCIV  
TOMB DEPOSITS: 1-14, No. **199** (*con-*  
*tinued*); 15-17, No. **89** (I. 335); 18-20,  
No. **82** (I. 334)  
6, 7 (II. 240)
- XCv-xcvii  
[DEPOSITS IN] TOMB No. **103** (I. 340-342,  
II. 226)  
xcvi 12 (II. 298)
- XCVIII  
TOMB DEPOSITS : 1-15, No. **177** (I. 344);  
16-26, No. **124** (I. 346); 27-29, No.  
150 (I. 358)  
1-7 (II 240)
- XCIX  
TOMB DEPOSITS: 1-5, No. **118** (I. 345);  
6-12, No. **128** (I. 347); 13, No. **213**  
(I. 381); 14 No. **158** (I. 365); 15,  
No. **169** (I, 369)  
1 (II. 269)
- C  
TOMB DEPOSITS: I, No. **123** (I. 345, 346);  
2-5, No. **131** (I. 349); 6-18, No. **64**  
(I. 331, 332); (19-28, No. **56** (I. 321);  
29-31, No. **80** (I. 334)
- CI  
[DEPOSITS IN] TOMB, NO. **124** (I. 346)
- CI a  
TOMB DEPOSITS : 1-12, No. **134** (I. 349);  
13-14 No. **206** (I. 380); 15, 16, No. **36**  
(I. 316)

## PLATE

## CII

TOMB DEPOSITS : 1-6, No. **138** (I. 350);  
7-14, No. **139** (I. 352); 15, No. 7  
(I. 306); 16-28, No. **144** (I. 354)  
7-8 (II. 140)

**cm**

[DEPOSITS IN] TOMB No. **142** (I. 353,

II. 211)

5 (II. 166)

## CIV, CV

TOMB NO. **147** [PLAN AND DEPOSITS] (I.  
355-358)

civ 3 (II. 228)

## CVI

TOMB DEPOSITS : 1, 2, No. **152** (I. 358);  
3-6, No. **142, 143** (I. 354) J 7, No. **66**  
(I. 332); 8, No. **194** (I. 376)

4 (II- 341)

## CVII

TOMB DEPOSITS : 1-19, No. **153** (I. 359);  
20, No. 227 (I. 386); 21-24, No. **242**  
(I. 387 \* 388)

23, 24 (II. 140)

## CVIII

TOMB NO. **156** [PLAN AND DEPOSITS]  
(I. 361-364)

7 (II- 140)

## CIX

TOMB DEPOSITS; 1-10, NO. 157 (I. 364,  
365); 11-17, No. **218** (I. 383); 18-29,  
No. **76** (I. 333); 30, No. **148** (I. 358);  
31, No. **145** (I. 355); 32, No. **201** (I. 379)  
17, 19 (II. 140), 32 (II. 82)

## CX-CXII

TOMB NO. **160** [PLAN AND DEPOSITS] (I.  
366, 367)

cx 2, 3, 10 (II, 288), cxii 12 (455)

## CXIII

TOMB DEPOSITS: 1-9, No. **167** (I. 368,  
369); 10-20, No. **155** (I- 359-360);  
21-23, No. **158** (I. 365); 23 a, No. **128**  
(I. 347); 24-27, No. **129** (I. 348)

## CXIV

[DEPOSITS IN] TOMB NO. **176** (I. 370-372)

## CXV

TOMB NO. **185** [PLAN AND DEPOSITS] (I.  
373, 374)

1-4 (II. 88), 5 (II. 140), 12 (II. 9)

## CXVI

TOMB DEPOSITS : 1-3, No. **189** (I, 374,  
375); 4, No. **220** (I. 384); 5-8, No.

## PLATE

**168** (I. 369); 9-13, No. **159** (I. 365,  
366); 14-19, No. 10 (I. 309); 20, 21,  
No. **33** (I. 316); 22, No. **154** (I. 359);  
23, No. **129** (I. 348)

## CXVII

[DEPOSITS IN TOMB] No. **193** (I. 375, 376)

## CXVIII

TOMB DEPOSITS : 1, No. **198** (I. 377);  
2, No. **205** (I. 379, 380); 3-18, No.  
**196** (I. 376, 377); 19-22, No. **194** (I.  
376); 23-27, No. **219** (I. 383); 28, No.  
**215** (I. 382)

15, 16 (II. 228), 42 (II. 82)

## CXIX

TOMB DEPOSITS : 1-7, No. **201** (I. 378,  
379); 8-24, No. **199** (I. 377, 378);  
25, No. **200** (I. 378); 26-29, No. **208**  
(I. 381)

5, 6 (II. 240), 22 (II. 82), 25 (II. 240)

## CXX

TOMB DEPOSITS : 1, No. **226** (I. 386);  
2-15, No. **224** (I. 385); 16-19, No. **125**  
(I. 346); 20-23, No. **223** (I. 384)  
16 (II. 140), 20 (II. 298), 21 (II. 82)

## CXXI, CXXII

TOMB NO. **252** [PLAN AND DEPOSITS] (I.  
389-392)

## CXXIII

GLASS VASES [FROM TOMBS] (II. 240)

1, 2 (I. 379), 3 (I. 380), 4 (I. 360), 5 (I- 359)  
6, 7 (I. 360)

## CXXIV-CXXVI

ANIMAL FIGURES (II. 1-22, 305)

exxiv 1, 2, 3, 7, 8, 11, 17, 20, 23 (II. 2),  
19, 22, 25, 36, 37 (II. 3), 4, 9, 20, 28  
(II. 6), 29, 30, 31, 35 (II. 7), 6, 8 (II. 8),  
34 (II. 9), 18 (II. 15), 10, 16, 21 (II.  
16), 32 (II. 17), 15, (II. 18), 24 (II.  
19), 26, 27 (II. 20), 5, 12 13, 33, 38  
(II. 22)

exxv. 9, 21 (II. 2), 4, 5, 6, 15, 16 (II. 3),  
20 (II. 4), 2, 14 (II. 6), 4, 8, 24 (II. 7),  
11, 17, 27 (II. 8), 18, 22 (II. 9), 19 (II.  
16), 3, 23 (II. 17), 12 (II. 18), 10, 13, 26  
(II. 19), 7, 25 (II. 22), 18 (II. 48)

exxvi. 23 (II. 1), 17, 18, 22, 25, 26, (II. 2).  
4, 11, 14, 15, 16 (II. 3), 12, 24 (II. 6),  
5, 20 (II. 8), 9, 19 (II. 9), 8, 21 (II. to),  
9 (II. 15), 1, 2, 3 (II. 16), 10 (II. 19),  
6, 13 (II. 22), 22 (II. 48, 159)

\* In vol. I. p. 387, line 6 from bottom, for "stoop" read "strap."

*Index to Plates*

PLATB

CXXXVII

THE CALENDAR TABLE (II. 24-28)

CXXXVIII

AGRICULTURAL IMPLEMENTS (II. 30-34)  
9 (II. 124)

CXXXIX

OLIVE-PRESSES (II. 48-67)  
1, 2 (II. 49), 3 (II. 55), 4 (II. 53), 5 (II. 56), 6 (II. 59), 7, 8 (II. 57). 9 (II. 58, 226)

CXXX

OLIVE-PRESSES OF NORMAL TYPE (II. 50)

CXXXI

OLIVE-PRESS ARD AIN EL-BUTMEH f (II. 54)

CXXXII

SPINDLEWHORLS AND BUTTONS (II. 70-73, 90-93)  
4-9 (II. 71), 10-12, 14-20 (II. 72), 21, 22 (II. 73), I, 37, 38, 53 (II. 90), 24-27, 29, 31-35, 40, 41, 43-49, 58 (II. 91), 2, 13, 23, 28, 30, 40-49, 51, 54, 60-63 (II. 92), 3, 17a, 36, 39, 42, 50, 52, 55, 56, 59 (II. 93)

CXXXIII

BRONZE PINS AND NEEDLES (II. 78, 79, 82-90)  
24, 26, 30, 48, 53 (II. 78), 31, 33-35, 37-40, 42, 49-52 (II. 79), 53 (II. 80), 1, 2, 4-9, 11, 15, 23 (II. 83), 3, 10, 12-14, 16-22, 25, 29, 54, 61, 63 (II. 84), 27, 28, 32, 36, 43, 56, 62, 67 (II. 85), 41 44-50, 53, 55, 57, 64, 65 (II. 86), 58-60, 66 (II. 87)

CXXXIV

FIBULAE, ETC. (II. 79-82)  
1-39, 42 (II. 80-82), 40 (II. 87), 41 (II. 97), 42 (II. 82, 100), 43 (II. 114)

CXXXV

BRONZE ORNAMENTS, ETC.  
1-12 (II. 115), 13-15 (II. 46), 16, 17 (II. 115), 19-22 (ornamental discs, top of a candelabra, and pin with two horizontal loops attached, from the Hellenistic stratum), 23 (II. 98), 23a (II. 101), 24 (II. 102), 25 (II. 47, 100), 26 (II. 100), 27-51 (II. 97-101)

CXXXVI

SILVER AND GOLD  
1 (II. 102), 2 (II. 450), 3 (II. 99), 4, 5 (II. 101), 6, 6a, 7 (II. 102), 8, 9 (II. 263), 10-16 (II. 261), 17 (II. 102, 261), 18 (II. 261), 19-22 (II. 260)

PLATB

CXXXVII

(a) HOARD OF BEADS, ETC. (II. 109-111),  
(b) BEADS (II. 104-113)

CXXXVIII, CXXXIX

FLINT IMPLEMENTS (II. 122-127 : *see also* II. 244)

CXL

POTTERY : COLOUR DECORATION (VARIOUS PERIODS)

I (II. 135), 2 (II. 151), 3 (II. 188), 4 (II. 151), 5 (II. 173), 6 (II. 151), 7 (II. 173), 8 (II. 169, 173), 9 (II. 159), 10, 11 (II. 163, 173), 12-15 (II. 156, 173), 16 (II. 188), 17 (II. 191), 18 (II. 189, 191), 19 (II. 191), 20 (II. 189), 21 (II. 174, 180), 22 (II. 188, 191)

CXLI-CL

FIRST SEMITIC POTTERY (II. 136-155)

cxli 5 (II. 139), 2, 8 (II. 140), 1, 3, 4, 6, 9-12 (II. 140), 1, 5, 7, 12 (II. 150), 5, 13 (II. 151)  
cxlii 22 (II. 138), 1-5, 9, 11, 12 (II. 139), 14 (II. 140), 13, 17 (II. 141), 4, 21 (II. 143), 18 (II. 144), 20 (II. 147), 19 (II. 148), 15 (II. 149), 6, 9, 10, 16 (II. 160), 7, 8 (II. 162), 19 (II. 171)  
cxliii 10, 16, 21 (II. 138), 11-13, 15, 19, 20 (II. 139), 14, 17, 18 (II. 140), 9 (II. 141), 1-8 (II. 142), 15 (II. 162)  
cxliv 18 (II. 72), 5 (II. 138), 4 (II. 141), 12 (II. 142), 15 (II. 144), 14, 17 (II. 145), 2, 3, 6 (II. 146), 8 (II. 147), 7, 16 (II. 148), 9-11, 13 (II. 149)  
cxlv 10 (II. 138), 14 (II. 139), 15, 16 (II. 140), 8, 9, 13, 17 (II. 141), 11 (II. 143), 12 (II. 146), 6, 17 (II. 150), 5 (II. 159), 1-4 (II. 161), 5 (II. 164), 18 (II. 166), 1, 2, 4 (II. 172), 3-5 (II. 173), 7 (II. 174)  
cxlvi 8, 20 (II. 140), 4, 9, 11, 17 (II. 141), 13, 19 (II. 142), 6, 10 (II. 144), 16 (II. 145), 18 (II. 146), 5 (II. 147), 15 (II. 148), 14 (II. 150), 1-3 (II. 151), 21 (II. 152), 16a (II. 158), 7 (II. 161)  
cxlvii 7, 18, 19 (II. 139), 3, 8, 10, 11, 25-27 (II. 140), 13, 20 (II. 141), 9, 12, 14, 22 (II. 142), 24 (II. 143), 4, 5 (II. 144), 1 (II. 145), 6 (II. 146) 21 (II. 147) 215 (II. 148), 16, 17, 23 (II. 150)  
cxlviii 14 (II. 141), 3, 7, 10, 11, 23, 26, 28, 29 (II. 143), 2, 12, 13, 19, 27, (II. 144), 14 (II. 145), 8, 24 (II. 147), 5, 21, 22 (II. 148), 4, 8, 9, 15, 16, 25 (II. 149), 1, 6, 17, 18, 20 (II. 150)  
cxlix 1, 4, 6 (II. 143), 3, 5, 13, 18-22, 25

- (II. 144), 4, 9 (II. 145), 8, 23, 26 (II. 147), 10 (II. 148), 11 (II. 149), 2, 7, 14, 15 (II. 150), 24 (II. 151), 12, 27 (II. 157), 16, 17, (II. 618)
- cl. 12 (II. 143), 6, 8 (II. 144), 16, 18-20 (II. 148), 1-15, 17, 21 (II. 149), 13 (II. 150)
- AEGEAN POTSDHERDS (II. 155)
- CLII-CLVII
- SECOND SEMITIC POTTERY (II. 155-176)
- clii 9 (II. 156), 1 (II. 159, 8, 17 (II. 161), 10 (II. 162), 21 (II. 163), 2, 5 (II. 165), 4, 3, 18 (II. 166), 6, 16, 20 (II. 167), 12 (II. 168), 8, 11, 14, 23, 24 (II. 170), 3, 7, 19, 22 (II. 171), 15 (II. 172), 3, 7 (II. 176)
- cliii 10 (II. 156), 1-5 (II. 158), 6-10, 15, 18, 19 (II. 160), 7-10, 12-14, 17, 21 (II. 161), 11, 16, 20 (II. 162), 22 (II. 163), 24-26 (II. 164), 23 (II. 165), 28 (II. 167) 27 (II. 168), 20 (II. 171)
- cliv 5, 29 (II. 160), 14, 16 (II. 161), 15, 22, 23 (II. 162), 8, 10, 12, 18-20 (II. 163), 1, 2, 4, 6, 7, 11, 17, 21, 24-26 (II. 164), 9, 13, 23, 28 (II. 166), 4 (II. 168), 27 (II. 171), 29 (II. 172), 3 (II. 175)
- clv 3 (II. 163), 15, 21 (II. 165), 1, 5, 7, 11 (II. 167), 4, 14, 18 (II. 168), 2 (II. 169), 8, 10, 13-15, 19, 22, 23 (II. 170), 9, 16 (II. 171), 20 (II. 172), 6 (II. 175), 12, 17 (II. 176), 7 (II. 185)
- clvi 1, 2, 10, 13, 16, 20 (II. 159), 3, 9, 11, 12, 15, 19 (II. 161), 4-6, 8, 14, 17, 18, 24 (II. 162), 35 (II. 163), 21 (II. 165), 1, 16, 22 (II. 167), 5, 7, 8, 11, 13, 24 (II. 168), 23 (II. 170), 3, 15 (II. 171), 26 (II. 172)
- clvii 4 (II. 161), 1, 2, 3, 22 (II. 167), 18, 19, 21, 23, 25 (II. 170), 17, 20, 24 (II. 171), 20 (II. 172), 15 (II. 173), 7, 9 (II. 174), 1-3, 5, 6, 8, 10-14, 16 (II. 175)
- CLVIII-CLXVIII
- THIRD SEMITIC POTTERY (II. 176-194)
- clviii 2 (II. 176), 3, 8 (II. 177), 15 (II. 178), 1, 7 (II. 180), 3, 11, 16 (II. 181), 9, 10, 12-14 (II. 182), 4, 10 (II. 183), 5 (II. 184), 6, 15 (II. 185), 1 (II. 187), 1, 3, 11, 15-17 (II. 188), 15 (II. 189)
- clix 2-4 (II. 176), 9 (II. 183), 7, 8, 12 (II. 188), 18 (II. 187), 1, 7 (II. 189), 5, 8, 10, 14, 17 (II. 190), 15, 16 (II. 192), 6, 11 (II. 193), 6, 13, 16 (II. 194)
- CLVIII-CLXVIII—continued.
- clx 13 (II. 176), 1 (II. 178), 3, 11 (II. 187), 10 (II. 188), 2, 3, 14 (II. 189), 1, 5, 7, 9, 14 (II. 190), 1, 4, 6 (II. 192), 7, 8, 9, 12 (II. 194)
- clxi 5, 8 (II. 177), 1, 2, 7 (II. 178), 3 (II. 179), 4, 6 (II. 180), 9, 10, 11, 13, 15 (II. 181), 14 (II. 183), 12 (II. 185), 1, 14 (II. 186), 16 (small saucer with painted decoration in black and red)
- clxii 11, 13, 14 (II. 180), 2, 4, 7, 8, 12, 18, 19 (II. 181), 1, 3, 5, 15, 17, 20-22 (II. 182), 6, 9, 10 (II. 183), 16 (II. 185), 9 (II. 201)
- clxiii 4 (II. 156), 4, 5, 9 (II. 178), 1-3 (II. 180), 4 (II. 187), 1, 3, 7 (II. 188), 2, 6, 7, 8 (II. 189), 137 (II. 192)
- clxiv 2, 3, 6-8, 12, 13, 16, 17, 19, 21 (II. 177), 1, 4, 5, 9, 11, 14, 15 (II. 178), 18, 20 (II. 179), 10 (II. 180)
- clxv 8 (II. 188), 3, 4 (II. 189), 2, 4, 10 (II. 190), 5 (II. 191), i, 2, 9, 11 (II. 192), 1 (II. 193), 1, 2, 6 (II. 194)
- clxvi 9 (II. 176), 3, 13 (II. 188), 2, 4, 7, 10 (II. 189), 4, 5, 7, 8, 11, 12, 14 (II. 190), 4, 10 (II. 191) 6 (II. 192), I (II. 194)
- clxvii 3, 6, 9, 17 (II. 188), 17 (II. 189), 7, 10 (II. 190), 11, 16, 17 (II. 191), 8, 12, 15, 16 (II. 192), 13, 17 (II. 193), i, 2, 4, 5 (II. 194)
- clxviii 20 (II. 181), 2, 6, 12, 13, 15, 16, 17 (II. 185) 11, 14, 18, 19 (II. 186), 10 (II. 187), 7 (II. 192), 8, 9 (II. 193). 1 3, 4, 5 (II. 194)
- CLXIX-CLXXVI
- FOURTH SEMITIC POTTERY (II. 195-211)
- clxix 16 (II. 158), 1, 22 (II. 195), 2-4, 8, 11, 13, 18, 19 (II. 196), 14, 19 (II. 197), 5, 15 (II. 198), 17, 20 (II. 199), 7, 9, 21 (II. 200), 6, 10, 12 (II. 201)
- clxx 2, 7 (II. 196), 5, 6 (II. 198), 1 (II. 199), 3, 4, 9, 11-13, 16 (II. 200), 10, 14, 15, 17 (II. 201), 8 (II. 203), 5 (II. 207)
- clxxi 7, 9 (II. 195), 2, 4, 12, 13 (II. 196), 3, 6, 11 (II. 197), 10 (II. 199), 14, 22 (II. 200), 15, 18 (II. 201), 16, 19 (II. 202), 20 (II. 203), 21 (II. 205), 1, 8 (II. 206), 5 (II. 207)
- clxxii 19 (II. 166), 1, 2, 4-7, 20 (II. 195), 9, 21 (II. 196), 13, 17 (II. 197), 22 (II. 198), 12, 23 (II. 199), 15 (II. 201), 27 (II. 203), 8 (II. 204), 3 (II. 205), 10, 17 (II. 206), 14, 16, 18, 24-26 (II. 207), 11 (II. 208)

## PLATS

## CLXIX-CLXXVI-continued,

- clxxiii i (II. 203), 2-17 (II. 208)  
 clxxiv 11 (II. 195), 15, 16 (II. 196), 2, 6,  
 7, 14, 19 (II. 200), 1, 3, 4, 5, 9, 10, 12,  
 13, 17 (II. 201), 8 (II. 203), 18 (II. 206)  
 clxxv 1 (II. 183), 10, 11 (II. 196), 7 (II.  
 198), 6 (II. 199), 9 (II. 201), 1 (II. 202),  
 2, 4, 5 (II. 203), 3, 8 (II. 206)  
 clxxvi 5 (II. 143), 10 (II. 196), 14 (II. 199),  
 6 (II. 200), 1-3, 11, 12 (II. 202), 4, 7,  
 18 (II. 204), 13 (II. 205), 8 (II. 206),  
 9, 16, 17 (II. 207), 15, 19 (II. 208)

## CLXXVII

GREEK POTSDHERDS (II. 212)

## CLXXVIII-CLXXXIV

- HELLENISTIC POTTERY (II. 211-226)  
 clxxviii 7 (II. 212), 6 (II. 213), 1 (II. 215),  
 12 (II. 216), 11 (II. 218), 18 (II. 219),  
 3, 4, 9 (II. 220), 2, 5, 8, 15-17 (II. 221),  
 10, 13, 14 (II. 222)  
 clxxix 2-6 (II. 212), 12, 14 (II. 214), 15,  
 19, 21 (II. 215), 16, 18 (II. 216), 7-11,  
 13, 17, 22, 23, 25-27 (II. 217), 20, 30  
 (II. 220), 24, 28 (II. 221), 1, 29 (II. 222)  
 clxxx 1, 2 (II. 213), 3, 6, 8, 10, 11 (II.  
 214), 4-5, 7, 14 (II. 215), 12 (II. 217),  
 9, 13 (II. 221)  
 clxxxi 1, 3, 6, 11, 14 (II. 214), 2, 4, 5,  
 6 *a*, 8-10, 12, 13, 16 (II. 215), 7, 15  
 (II. 217)  
 clxxxii 2 (II. 213), 4 (II. 215), 3 (II. 216),  
 1, 15 (II. 217), 9, 10, 13 (II. 220), 5, 7,  
 (II. 221), 3, 6, 7, 11, 12 (II. 222), 8, 14  
 (II. 223)  
 clxxxiii (II. 218)  
 clxxxiv 11 (II. 216), 12 (II. 218), 13, 14  
 (II. 220), 1, 2, 4-8, 10 (II. 222), 3, 9,  
 10 (II. 223)

## CLXXXV-CLXXXVII

- CONTENTS OF CISTERN IN IV II (II. 225)  
 clxxxv 4 (II. 166), 5 (II. 213), clxxxvi 1  
 (II. 207, 213, 221), 2 (II. 213), 3 (II. 217)  
 clxxxvii 13 (II. 217)

## CLXXXVIII

THE CANDLESTICK LAMP AND ITS VARI-  
 TIES (II. 227)

## CLXXXIX

ARAB POTTERY, ETC. (II. 229, 230)  
 34 (II. 244)

## CXC

POTTERS' MARKS  
 1-19a (II. 152), 20-41 (II. 176), 42-66  
 19a (II. 194), 67-88 (II. 209)

## PLATE

## CXXI

## JAR-STOPPERS

1-5, 18 (II. 169), 6, 7, 8 (II. 186), 20 (II.  
 206), 9 (II. 209), 11, 14, 15 (II. 220),  
 12, 13, 16, 17, 19 (II. 221)

## CXCII

BRONZE AXE-HEADS (II. 241-243, 376)

## CXCIII

CARPENTERS' TOOLS (II. 244, 245)

## CXCIV

CARPENTERS' TOOLS (I I. 245-247)

## CXCv

INLAYS (I I. 248-250)

## CXCvi

STONE MISCELLANEA (II. 253-258)

## CXCvii

METAL MISCELLANEA, 1-27, BRONZE (II.  
 266-267), 26-41 IRON (II. 270, 271), 27  
 (II. 261)

## CXCviii

KNIVES (BRONZE) (II. 268)

## CXCix

KNIVES (IRON) (II. 271, 272)

## CC

SEALS (II. 294-298 : *see also* 223)

## CCI

DRAUGHTBOARDS [AND DRAUGHTMEN] (I.  
 299-302)

## CCii-CCix

SCARABS, ETC.

*See* lists of Seals (II. 294, 330), Scarabs  
 (II. 314), Scarab-sealings (II. 329),  
 Cylinders (II. 344), and Amulets (II.  
 331), for descriptions of objects figured  
 on these plates.

## CCV6

PORCELAIN SAUCER (II. 338)

## CCX

EGYPTIAN AMULETS (II. 331-334)

## CCXI

EGYPTIAN FIGURES AND FAKENCE  
 1-12 (II. 335), 13-28 (II. 337)

## CCxii

ALABASTER (II. 339-342)

## CCxiii

STONE SAUCERS (II. 273): ALABASTER  
 (*continued*)

## CCxiv

CYLINDERS, ETC. (II. 344-347)

## CCxv

ARROW- AND JAVELIN-HEADS (II. 371-374)

## PLATS

## CCXVI

BRONZE SPEAR-HEADS (II. 374-375)

## CCXVII

SPEAR-HEADS (II. 375)

## CCXVIII

SWORDS, ETC. (II. 375, 376)

## CCXIX

SHAKIF EZ-ZUTT (II. 411)

## CCXX, CCXXI

HATHOR-ASHTORETH PLAQUES (II. 411  
416)

## PIATB

## CCXXII, CCXXIII

LIMESTONE FIGURES (II. 421-423)  
Standing Stones in V 29 (II. 406)

## CCXXIV

TABLES OF OFFERINGS (II. 425-447)

## CCXXV

*Ex VOTO* OFFERINGS (II. 437-446)  
13 (II. 21, 446)

## CCXXVI

Amulets (II. 450-453)

## A TABLE OF REFERENCE-LETTERS ON THE PLANS, PLATES I-VII \*

a, Cup-mark	j, Jar-burial	r, Reservoir
b, Pillar-base	k, Brick	s, Stone doorpost
c, Cistern	l, Lamp-and-bowl deposit	t, Baking oven
d, Drain or watercourse	m, Olive-press	v, Vat
i, Interment	p, Pavement	x, y, z, <i>See</i> I. 162

1 2 A, Hollow in rock, I. 153.

1 2 B, Olive-press in rock, II. 49 (where *for* "I i C" read "**I 2 B**").

I 4 A, Rock-cuttings associated with Cave 4 I, I. 78.

I 4 (S end), Group of cup-marks, etc., I. 154 (where *for* "I 5 A B" read "I 4 S. end").

I 5 A, Cup-marks united by a channel, I. 154 (where *for* "I 6 N. end" read "15 A").

18 A, Step against a house-wall, I. 186.

110 A, Natural hollow with vats, I. 154.

1 12 A, Cup-marks united by a channel, I. 154.

1 15 A, Cup-hollow in rock, 3' 6" across, 4' deep, found full of barley.

119 A, Natural hollow artificially rounded, I. 154, II. 387.

121 A, Circular pit in rock, 6' 6" across, 1' 6" deep (probably an olive-press).

129 A, Rock-cut vat, I. 155, 156.

I 30 A, Masonry surrounding rock-cutting, I. 154.

111 (middle), Hearth, I. 198 (where *for* "D east of trench I" read "in middle of trench I").

112 A, Standing stone, I. 237, II. 377, 378.

113 A, Foundation deposit, II. 427.

114 A, Domestic altar, II. 425.

**II 4 B**, Heap of stones, I. 191 (where *for* "I 13 B" read "II 4 B").

114 C, Pit in rock I. 153 (where make a similar correction).

115 A, A circular vat about 7' in depth, built of stone, plastered inside.

II 13 A, Room of a house destroyed by fire, containing a large number of weavers' weights and burnt corn.

1117 *bb* Well-rounded pillar-bases, I. 192 (where *for* "II 17 *cc*" read "II 17 *bb*").

1118 A, Rock dwelling adapted as a cistern, I. 269.

II 20 A, Hearth of four stones on end, I. 195.

**II 20 B**, Brick walls in the High Place Area, II. 399.

**II 20 C**, Circular structure full of burnt corn.

**II 20 D**, Hearth, I. 195.

\* After the early sheets of vol. I had been printed off it was decided that to print the lettering on these maps in blue would be unnecessary. The footnote on p. ix must therefore be revised.

## H

### *Table of Reference-Letters*

- II20E**, Masonry with vertical shaft, I. 201 *note*.  
II 21 A, Shaft in city wall, I. 203.  
II 21 B, Jar-burial with pottery, II . 432.  
II21 C, Flat stone, 2' 4" across.  
II26 A, Cemented pool, I. 276, 277.  
II28 A, Circular structure of massive masonry about 6' diameter.  
III 2 B, Cistern containing skeletons, II . 429.  
III 13 A, Inverted perforated jar (? beehive), II . 67, 68.  
III 13 B, Door-socket shewn in I. 184, fig. 71.  
III 13 C, Position of hoard of beads described II . 109 *et seq.*  
III 18 A, Pillar-base, I. 192.  
III 20 A, Pile of skulls, II . 367.  
III 21 A, Shaft in city wall, I. 203.  
III 27 A, Large pile of flint chips.  
III 30 A, Two slabs on edge at right angles, with a pile of pottery vessels leaning against them. (In I. 192 for "III 30 A" read "at N. end of III 29.")  
IV 2 B, Cistern containing skeletons, II . 429.  
IV4A-D, Details in house, described, I. 196.  
IV 8 A, Deep grain-pit, I. 201.  
IV 8 B, Chamber with large stones in the foundation of its walls, I. 176.  
IV 18 A, Square building associated with cup-mark, I. 154.  
IV 19 A (north), Four jars standing on end.  
IV 19 A (south),  $\Phi$ -shaped chamber, I. 203, 204 (where for " at the S. end of V 19 " read "at IV 19 A").  
IV21 A, Row of stones in floor of house, I. 191, fig. 79.  
IV26A, Wall 2' thick resembling the wall *aa* described in II . 406, built of long stones: one of them .4' in length.  
**IV29C**, Set of steps, I. 194.  
IV30 A, Large olive-press, described, II . 66-67.  
IV 30 B, Tapering slab standing on end, 2' 5" high, 1' thick, 1' 10" broad at bottom, 1' 4" at top, with a round hole 9" in diameter pierced through 3½" below the top. (In I. 192, line 26, insert "south of" before "**IV30B**.")  
V 2 B, Cistern containing skeletons, II . 429.  
V 3 A, Hearth, I. 199.  
V 4 A B, Long wall descending to rock, I. 166.  
**V5B** (in the chamber S. of the thick wall), Drain of jars, I. 278.  
**V9A**, Stones on edge, probably a hearth, I. 195.  
V 13 A (the round structure), Granary, I. 196.  
**V20A**, The chamber which contained the Ashtoreth Karnaim, II . 419.  
V 20 B, Collection of stone weights of an olive-press.  
**V20C,D**, Stone columns, I. 192.  
V 21 A, Circular wall plastered inside.  
**V21 B**, Long flat stone slab, II . 65.  
**V21 C**, Small vat full of black ashes, II . 65.  
**V28A**, Columns of a verandah, I. 191.  
V 29 A, Circular vat 3' 6" deep, built up of stones lined with cement.  
**V30 A**, (the wall running east and west at the extreme top of the trench), Wall described, I. 177 (where for "V29 A" read "**V30A**").

- V 30 A (south), Standing stone 4' 5" high x 2' x 1' 4" tapering to top.  
**V 30 B**, Stone with hieroglyphic letter, II. 307. (In I. 272 insert the words "a pit north-west of " before " V 30 B.")  
V 30 C, Drum of a column lying on the wall, 1' 7" in diameter, 1' high.  
**VI 2 A**, The Maccabaean wall, I. 280-282.  
**VI 2 B**, The cistern containing skeletons, II. 429.  
**VI 3 A**, Water channel, I. 277, 278.  
**VI 4 A**, Pillar-base, I. 192.  
**VI 14 A** (the block at the middle of the upper long wall, east of the reservoir), Step, I. 195.  
**VI 18 A**, Peculiar cistern, I. 270.  
**VI 21 A**, Midden-heap, II. 21.  
**VI 27 A**, Long stone running through wall, I. 179.  
**VI 27 B**, Flight of steps, I. 195.  
**VI 28 A** (north), Fragment of pavement, I. 184.  
**VI 28 A** (south), Stone door-post with hole drilled for bolt.  
**VI 29 A**, (north) Water drain, I. 278.  
**VI 29 A** (south), Wall shewn, I. 178, fig. 65).  
**VI 29 B** (on the course of the wall running eastward from D in trench 30, and immediately south of the broken angle above it), Opening spanned by lintel, I. 187 (where read "**VI 29 B**" /or "**VI 17 B**."  
**VI 29 B** (south), Vat in pavement, I. 184.  
**VI 29 C**, Colonnade, I. 193.  
**VI 29 D**, Hearth, I. 195.  
**VI 30 A, B**, Circular structures, I. 201.  
**VI 30 C**, Two stones described and illustrated, I. 186.  
**VI 30 D**, Reconstructed building, I. 175.  
**VI 30 E**, Block of stone, 1' 6" X 1' 7 x 1' 8", I. 192 (where for " VI 18 E" read "**VI 30 E**."  
**II a 29 A**, Vat in plastered pavement, I. 183.  
**II a 29 B**, Brick step, I. 194.  
**III a 30 A**, Circular pits in pavement (so lettered), I. 184 : beside them a wall referred to in I. 176.  
**III a 30 B**, Pavement of four large flat stones (so lettered), I. 183.  
**V a 27 A**, Fragment of pavement sloping upwards at an angle of about 30°.  
**V a 29 A**, Row of three stones end to end, I. 178.  
**V a 30 A**, Pillars with square drums, I. 192.





# I. ROCK-SURFACE § CAVE 5, WITH THE EARLIEST WALLS (BEFORE B.C. 2500)

30 29 28 27 26 25 24 23 22 21 20 19 18 17 16 15 14 13 12 11 10 9 8 7 6 5 4 3 2 1

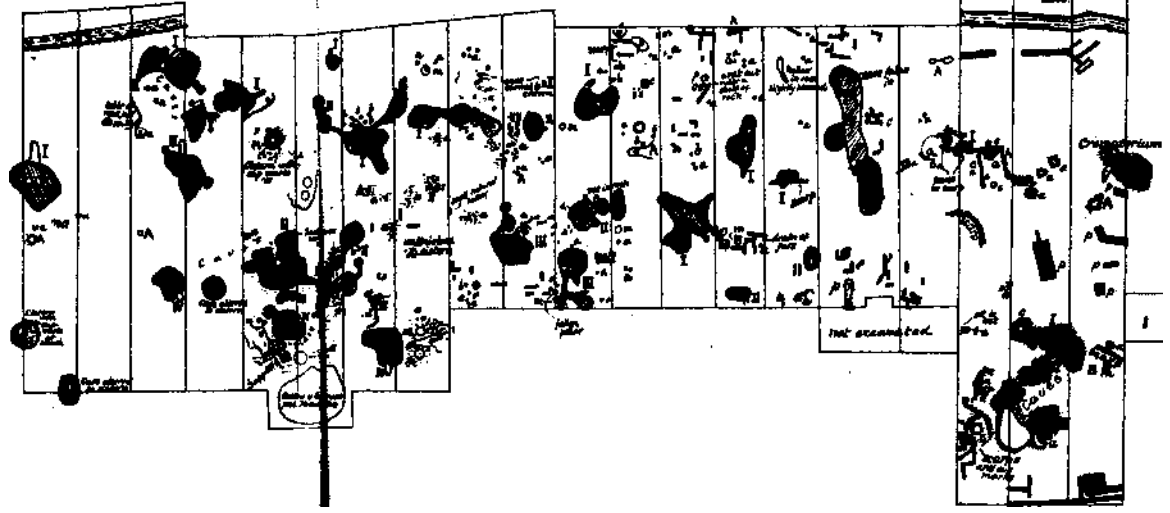
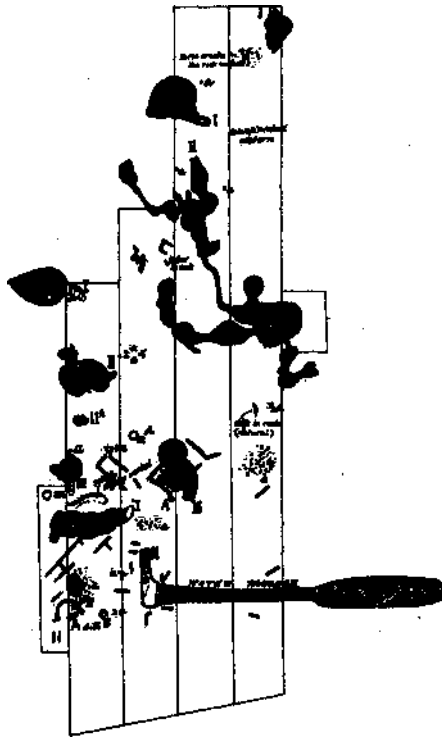

• to 110 XV ft\*

10 0 H 10 20 30 40





## II. FIRST SEMITIC PERIOD (c.B.C.2500-1800):

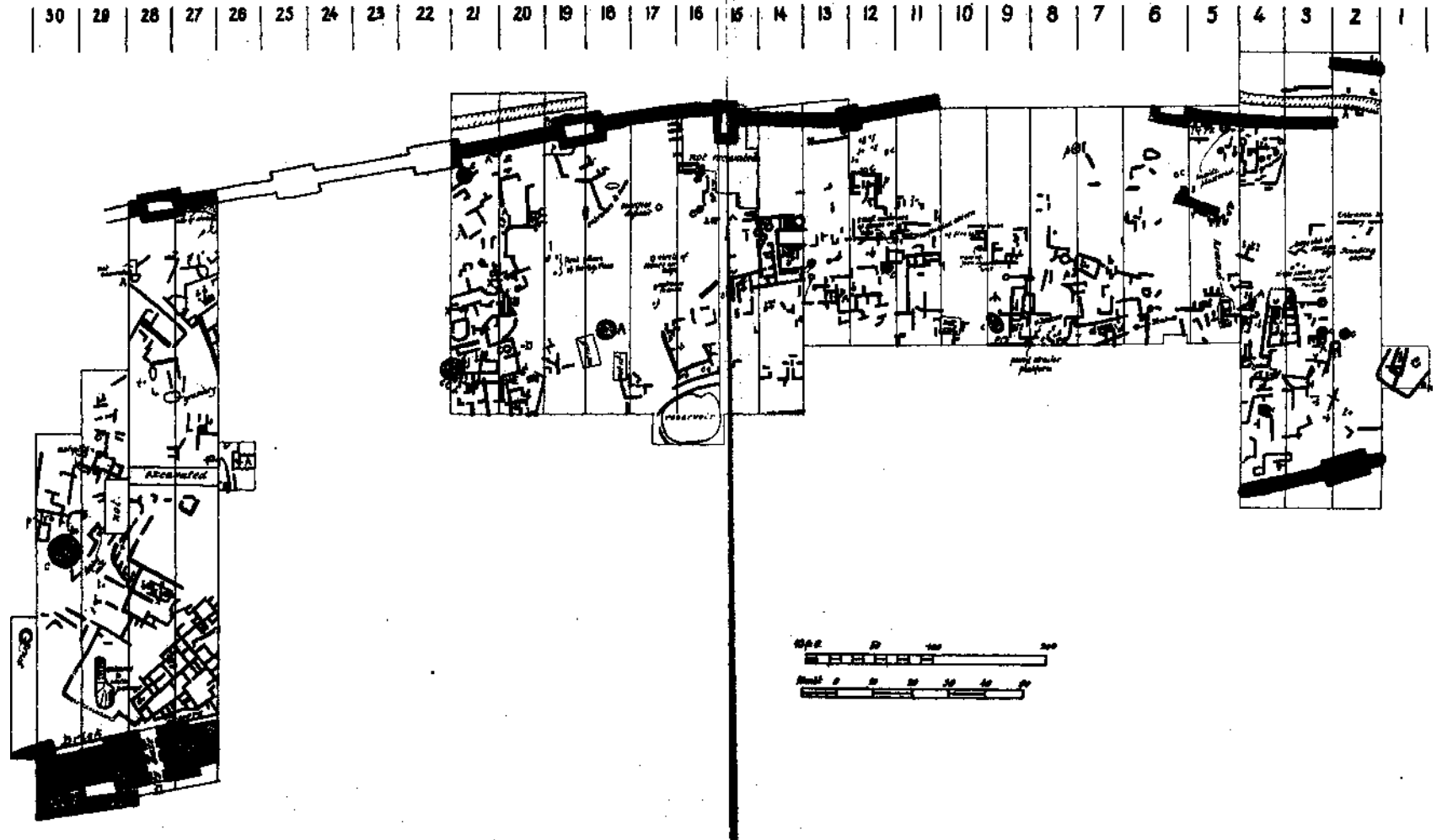





# .SECOND SEMITIC PERIOD (c.B.C. 1800-1400)

30 29 28 27 26 25 24 23 22 21 20 19 18 17 16 15 I 4 13 12 II 10 9 8 7 6 5 4 3 2 I

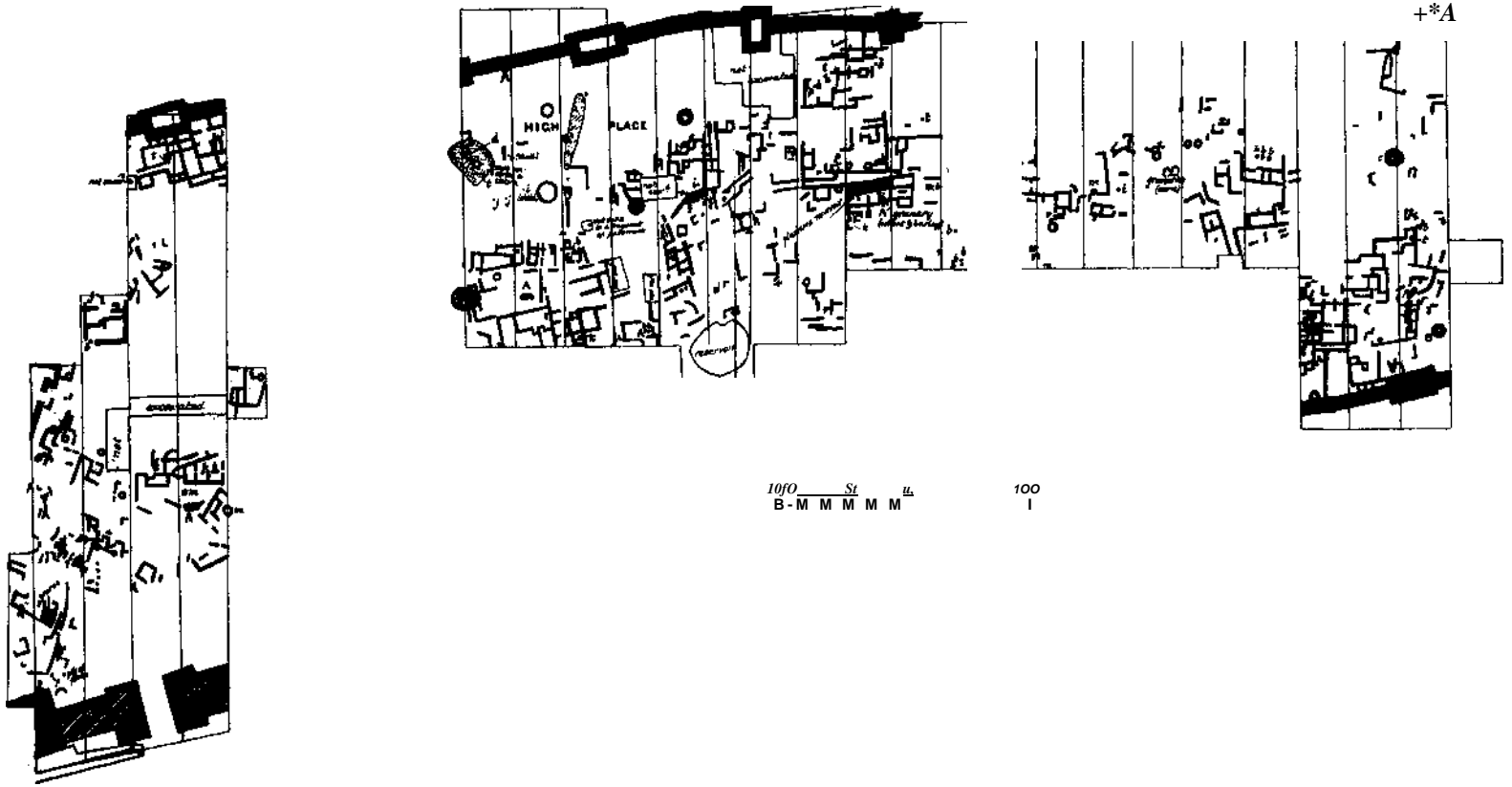

### IV. THIRD SEMITIC PERIOD (c.B.C400-1000)

I 30 I 29 I 28 I 27 I 26 I 25 I 24 I 23 I 22 I 21 I 20 | 19 I 18 I 17 I 16 | 15 I 14 I 13 I 12 | 11 | 10 | 9 | 8 | 7 | 6 | 5 | 4 | 3 | 2 | 1 |







## V. FOURTH SEMITIC PERIOD (c.B.C. 1000-550)

30	29	28	27	26	25	24	23	22	21	20	19	18	17	16	15	14	13	12	11	10	9	8	7	6	5	4	3	2	1
----	----	----	----	----	----	----	----	----	----	----	----	----	----	----	----	----	----	----	----	----	---	---	---	---	---	---	---	---	---

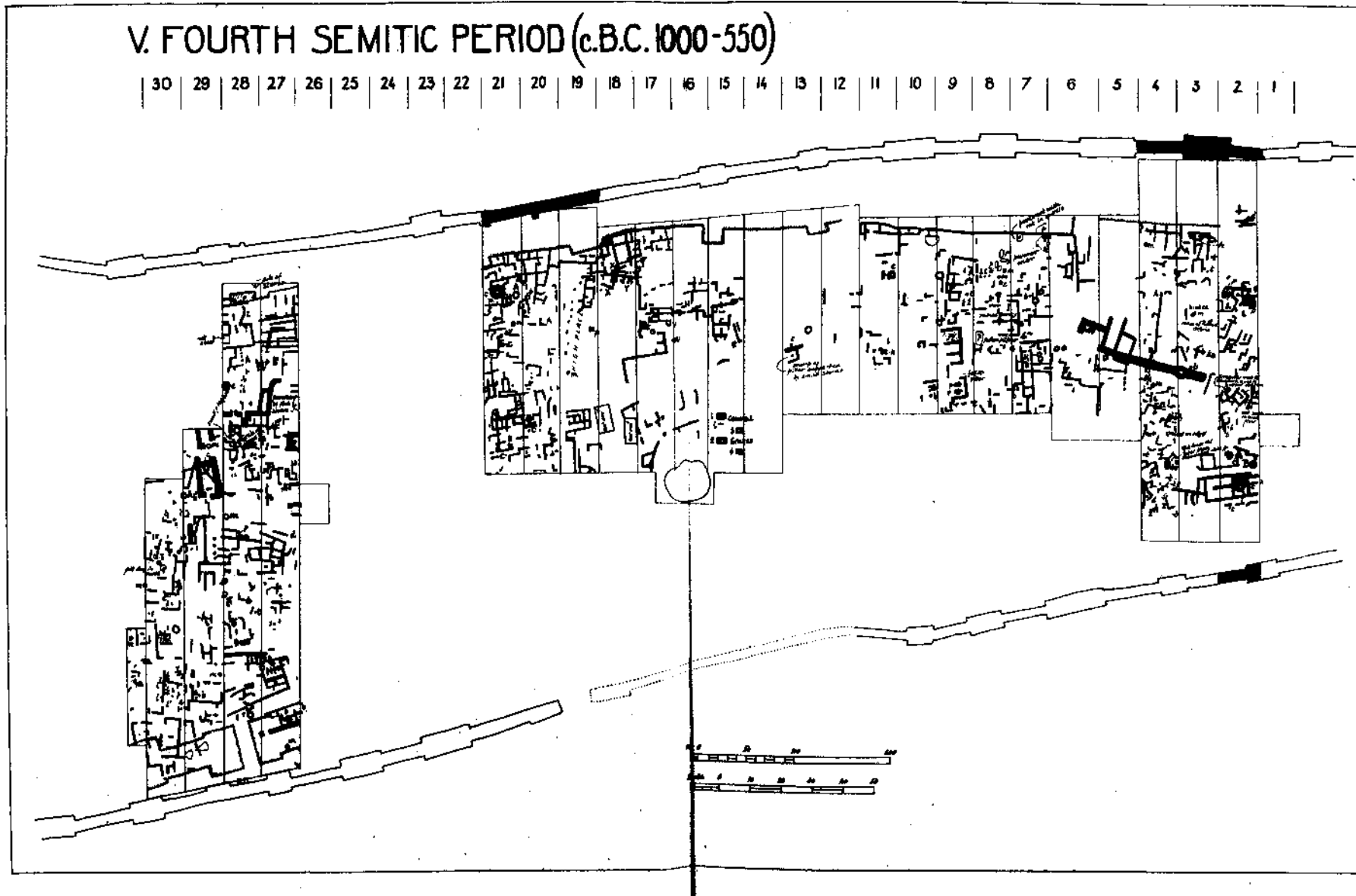





# VI.HELLENISTIC PERIOD (c.B.C.550-|00|

I 30 I 29 I 28 I 27 I 26 I 25 I 24 I 23 I 22 I 21 I 20 I 19 | 18 I 17 | I 6 II 15 I 14 I 13 I 12

10 I 9 I 8 I 7 | 6 15 14 13 12 11 |

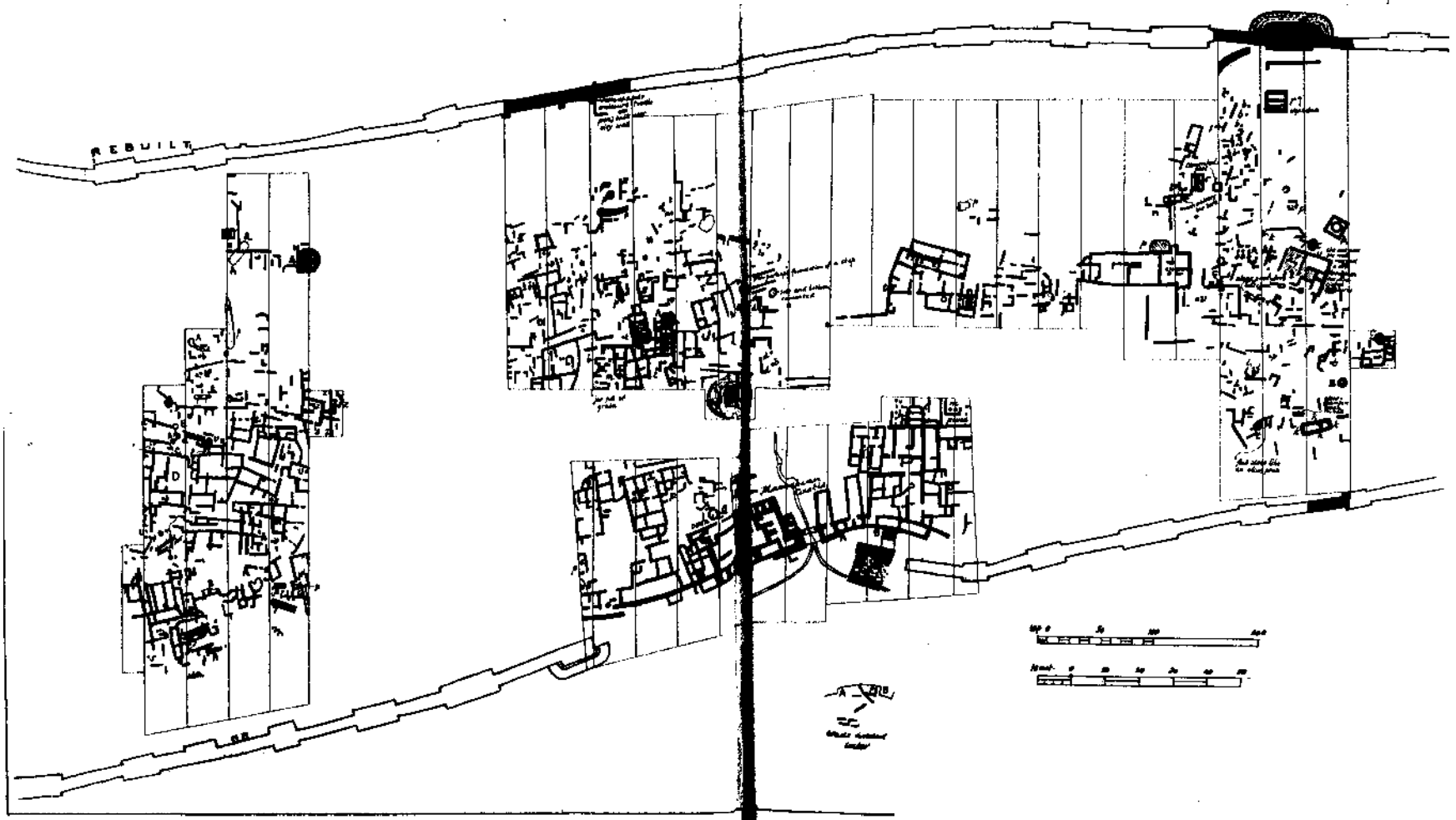



## INTERMEDIATE STRATA ON WESTERN HILL

IIa

*(between II and III - circa D.C. 300)*

30	29	26	27	26
----	----	----	----	----

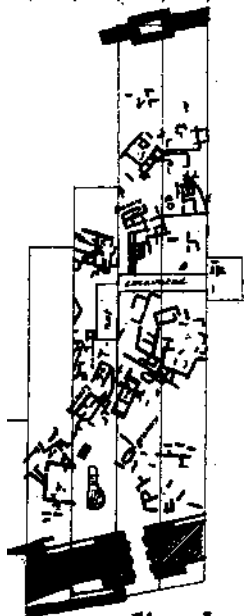

IIIa

*(between III and IV - circa D.C. 600)*

30	29	28	27	26
----	----	----	----	----

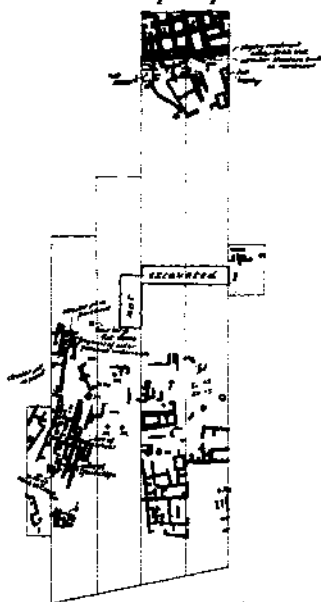

Va

*(between Vana VI - circa B.C. 700)*

30	29	28	27	26
----	----	----	----	----

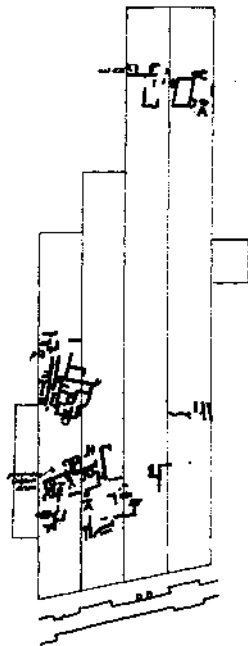





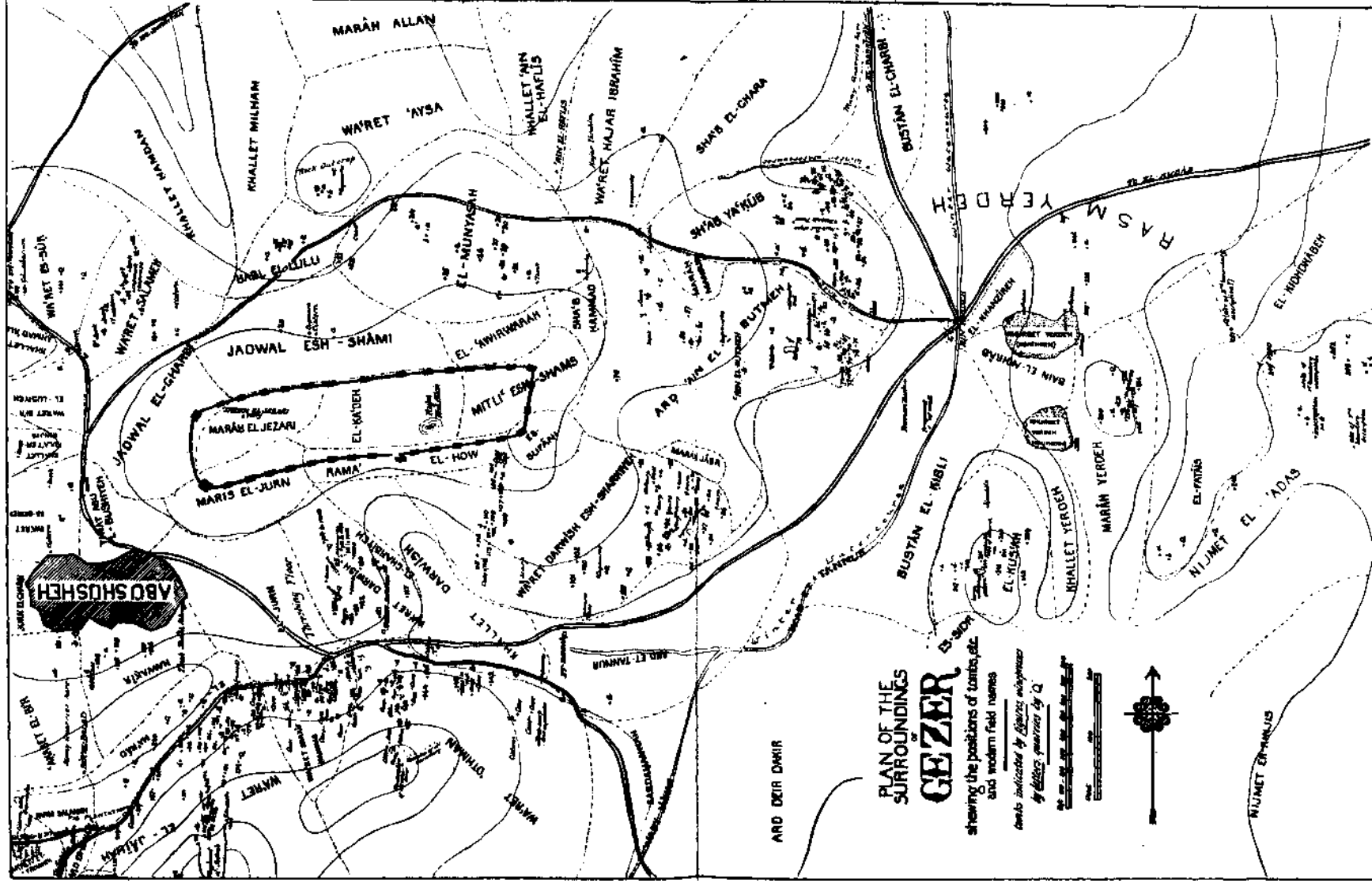

PLAN OF THE  
SURROUNDINGS  
OF  
**GEZER**

showing the positions of towns, etc.  
and modern field names

roads indicated by *double* and *single* lines  
of *ditto* marked by *Q*



ARD DEIR DHIR

NIJMET EL-HALIS









Plate ix

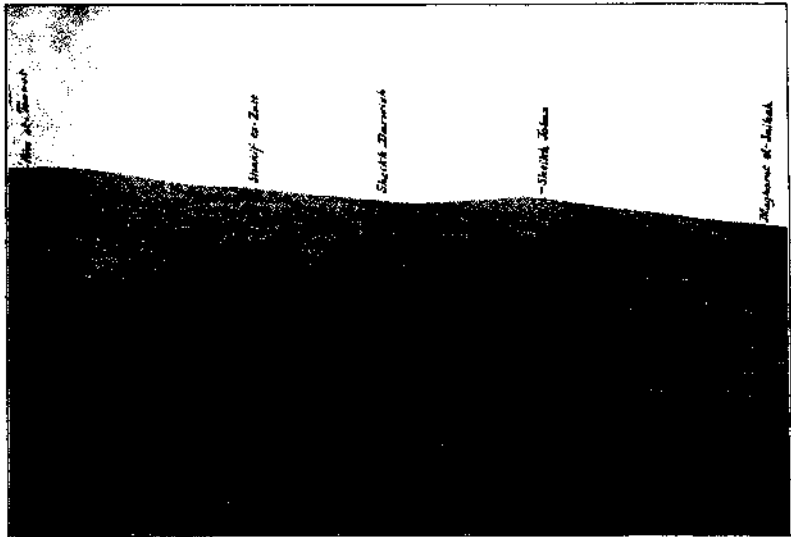

FIG. 1: HILLS SOUTH OF GEER

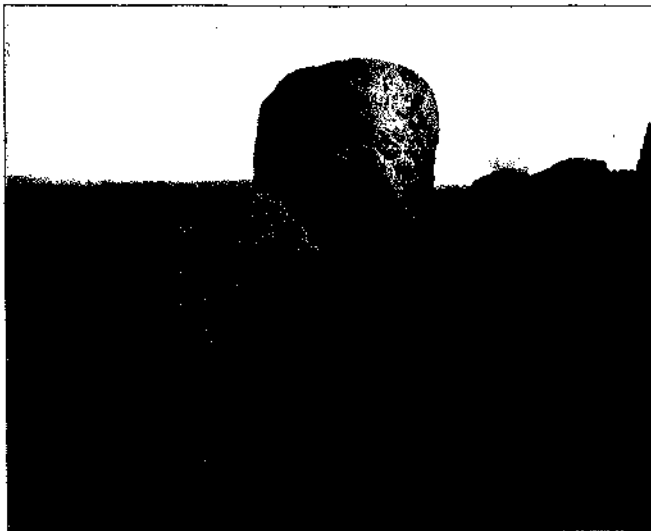

FIG. 2: THE "HAJAR ISRAHIM"

Plate x



FIG. 1

FIG. 2

FIG. 3





Fig. 3



Fig. 4

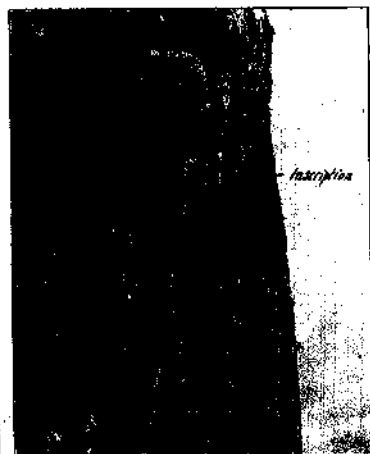
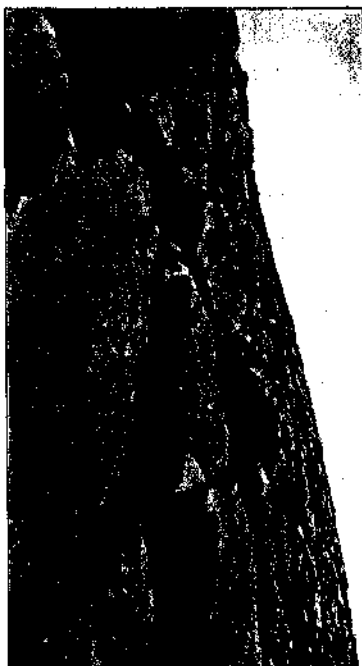

Plate xii



MODERN

FELLHIN OF THE DISTRICT





CAVE PLANS

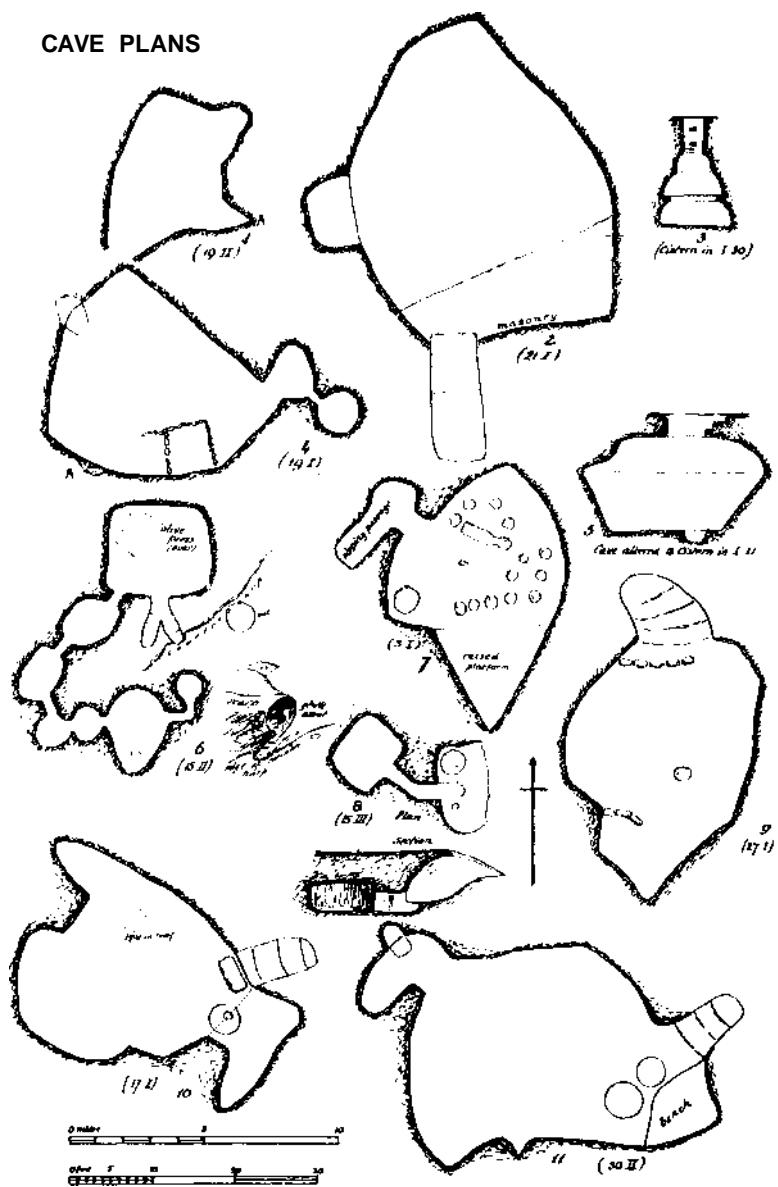

CAVE PLANS

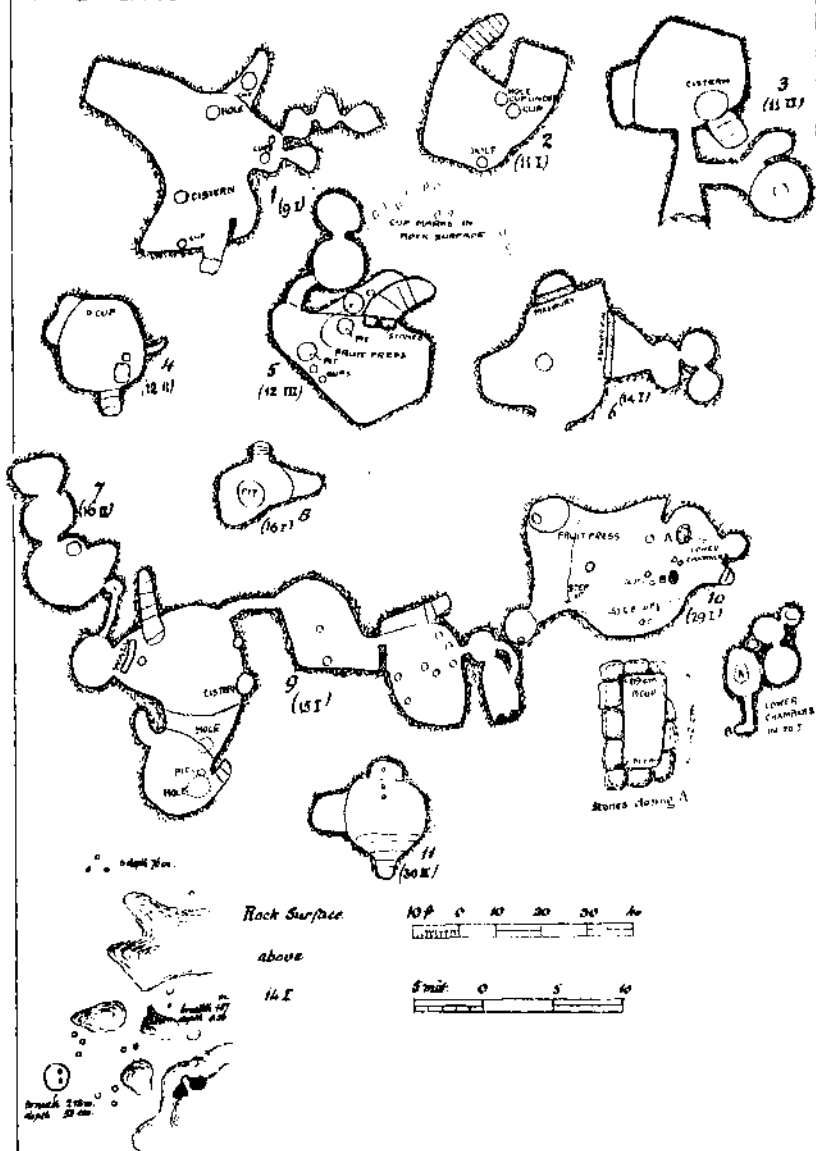



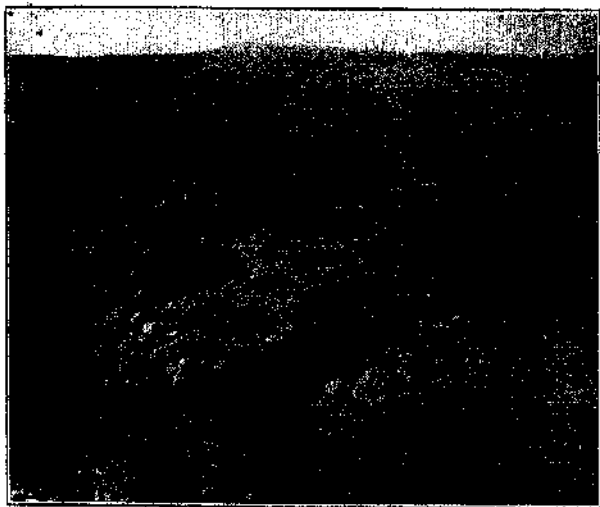

FIG. 1



FIG. 2

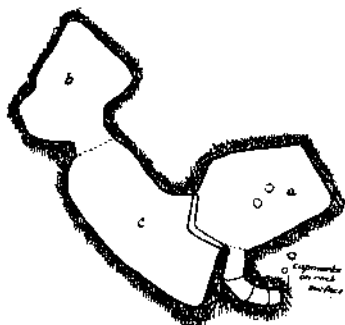
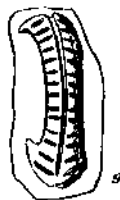
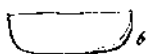
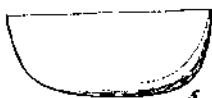
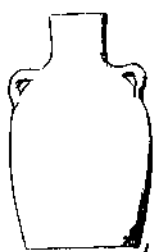

FIG. 3





# CAVE 3 III AND ITS CONTENTS



cm	0	1	2	3	4	5	6	7	8	9
----	---	---	---	---	---	---	---	---	---	---

for the plan

cm	0	1	2	3	4
in	0	1	2	3	4

ROCK SCARP WITH CUP MARKS

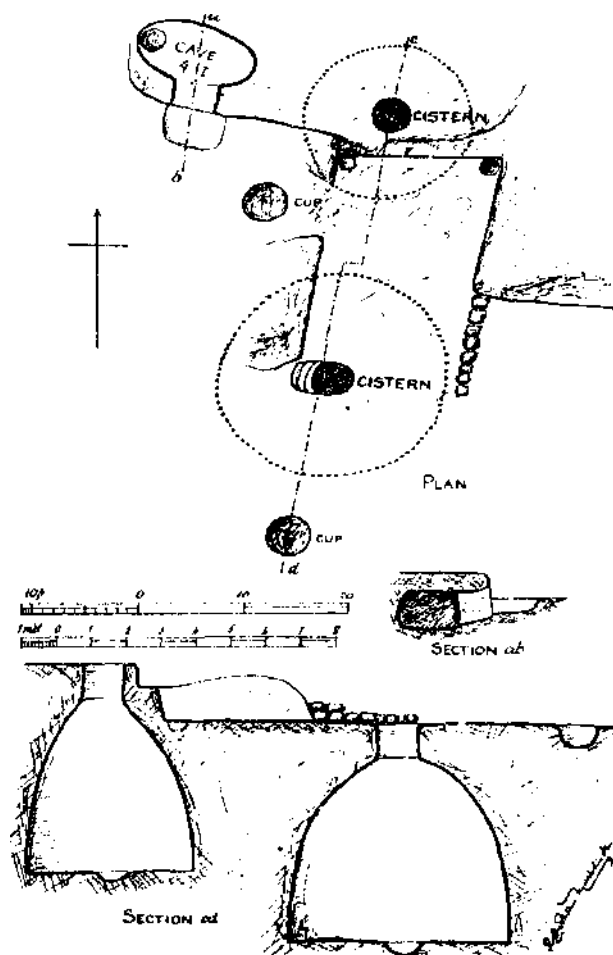





CONTENTS OF CAVE 81

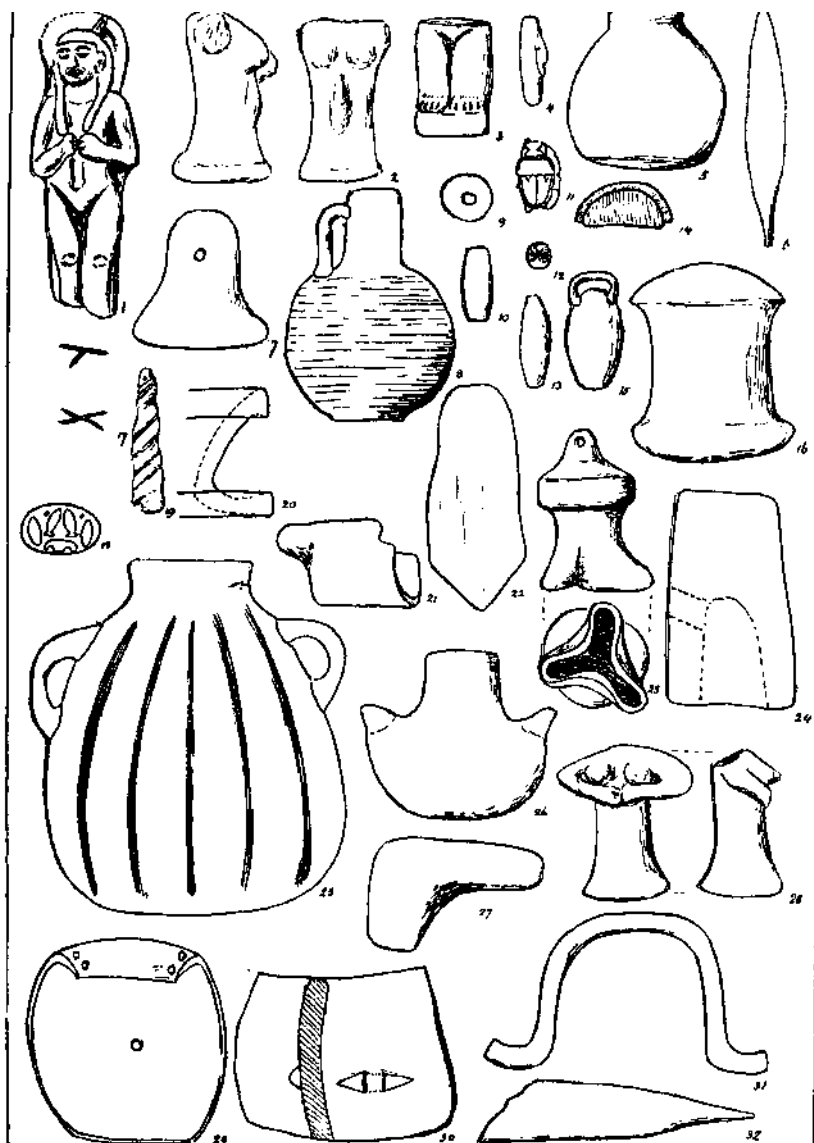

CONTENTS OF CAVE 1111

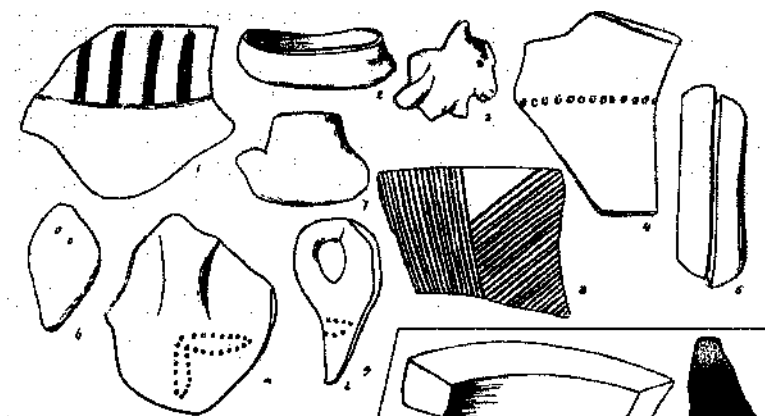

CONTENTS OF WATER-PASSAGE



CONTENTS or CISTERN

EAST OF TOMB No. 11

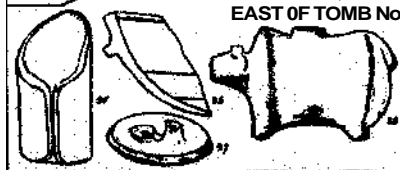

figs 25 26 28 to half scale

CONTENTS OF CAVE 151

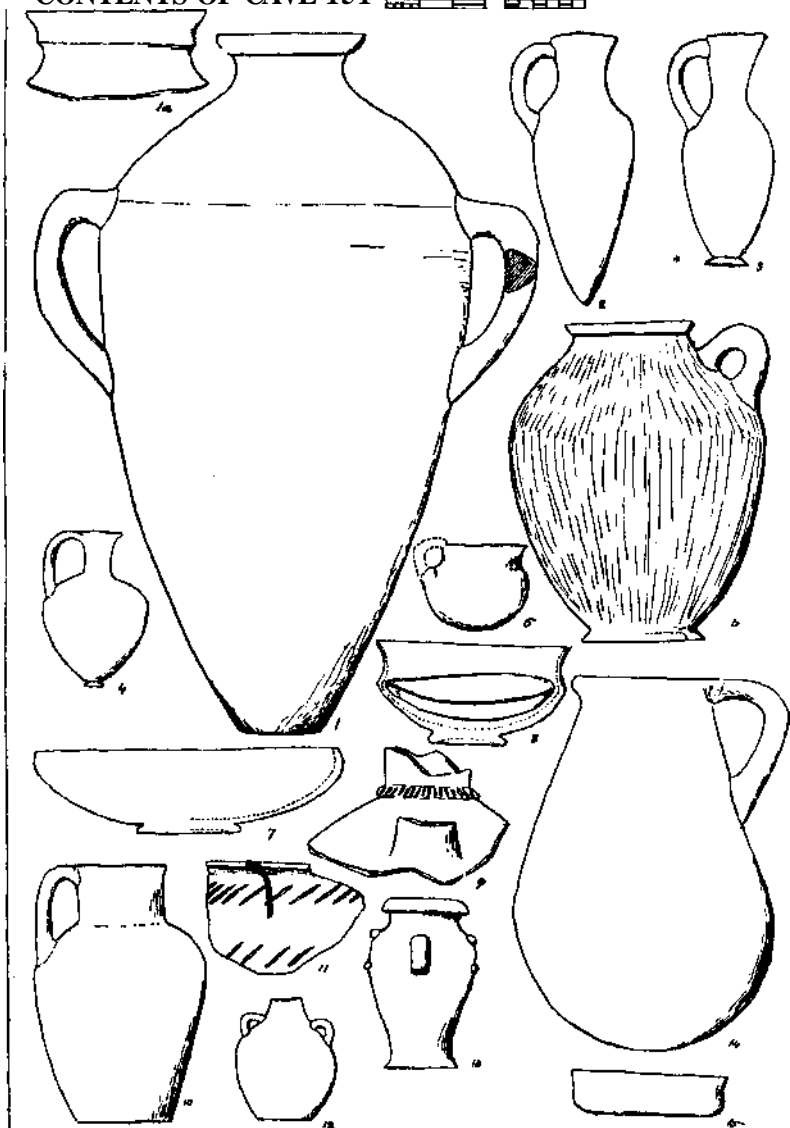

## CONTENTS OF CAVE 151

Over 1 2 3 4 Age 1-3, 17, 24, 27 and  
 Tools fig. 20 quartz tools

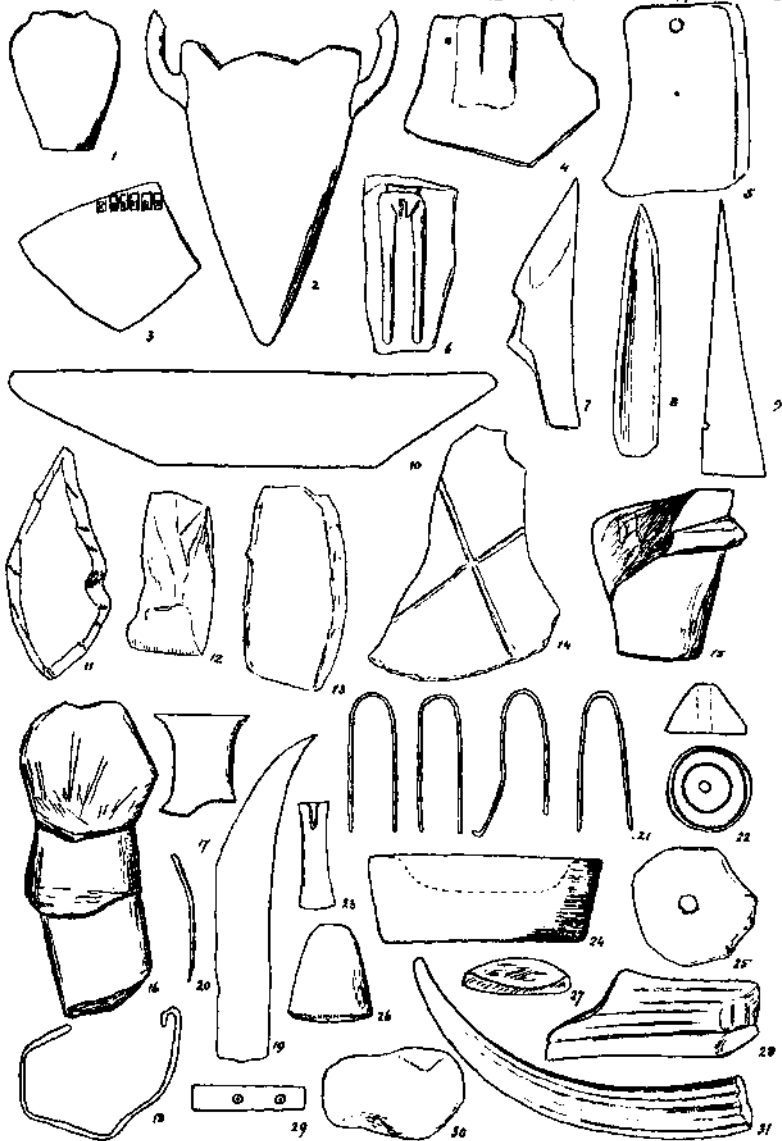

CONTENTS OF CAVE 15 I

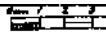
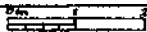
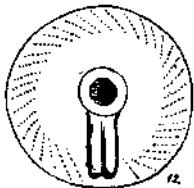
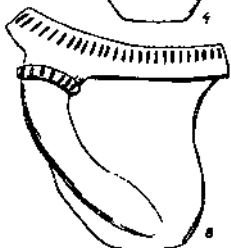
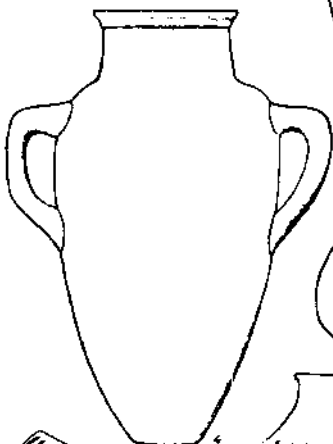
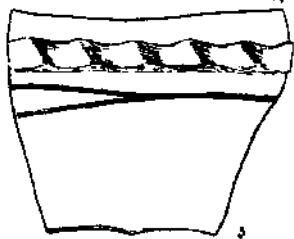
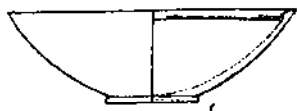
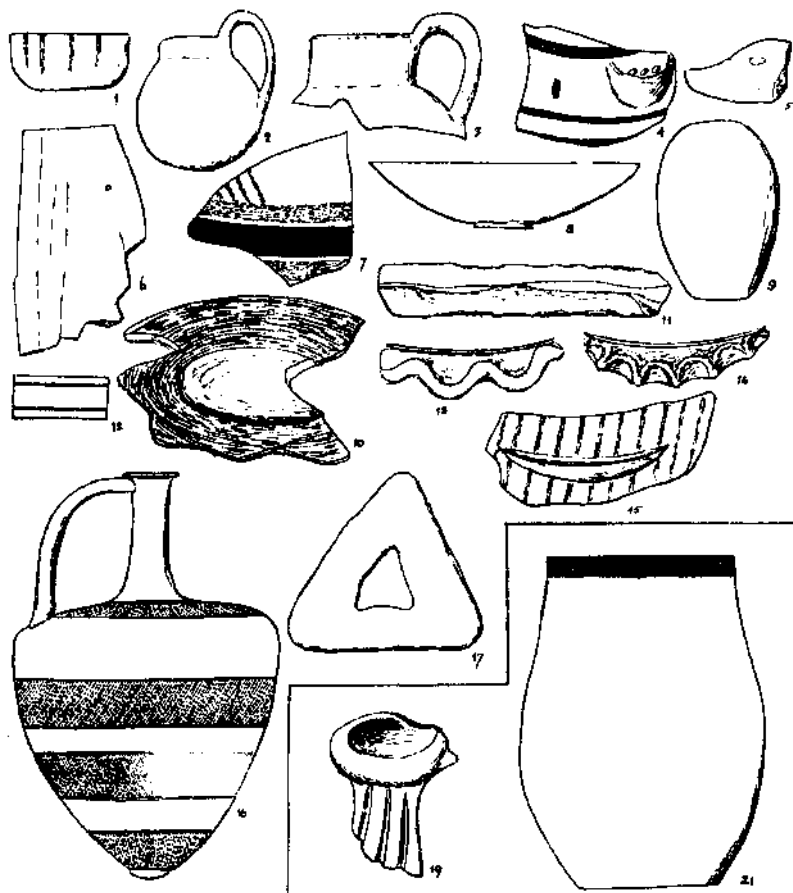

Fig. 2.1. 10  
Half scale



CONTENTS OF CAVE 15 I



CONTENTS OF CAVE 30 IIa

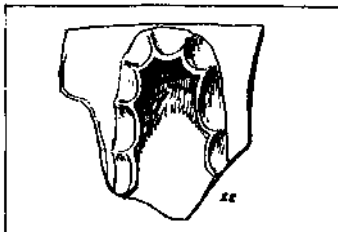
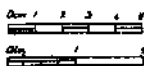





CONTENTS OF CISTERN IN CAVE 1511



CAVE 15IV AND ITS CONTENTS

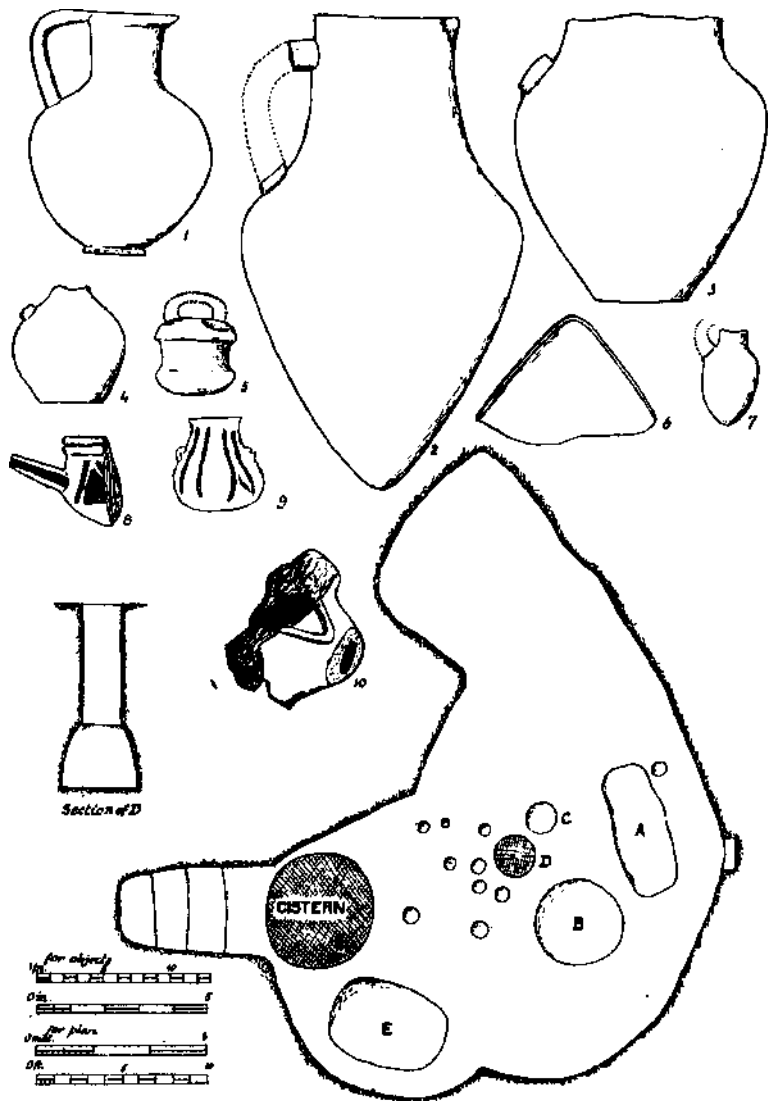





CONTENTS OF CAVE 15IV

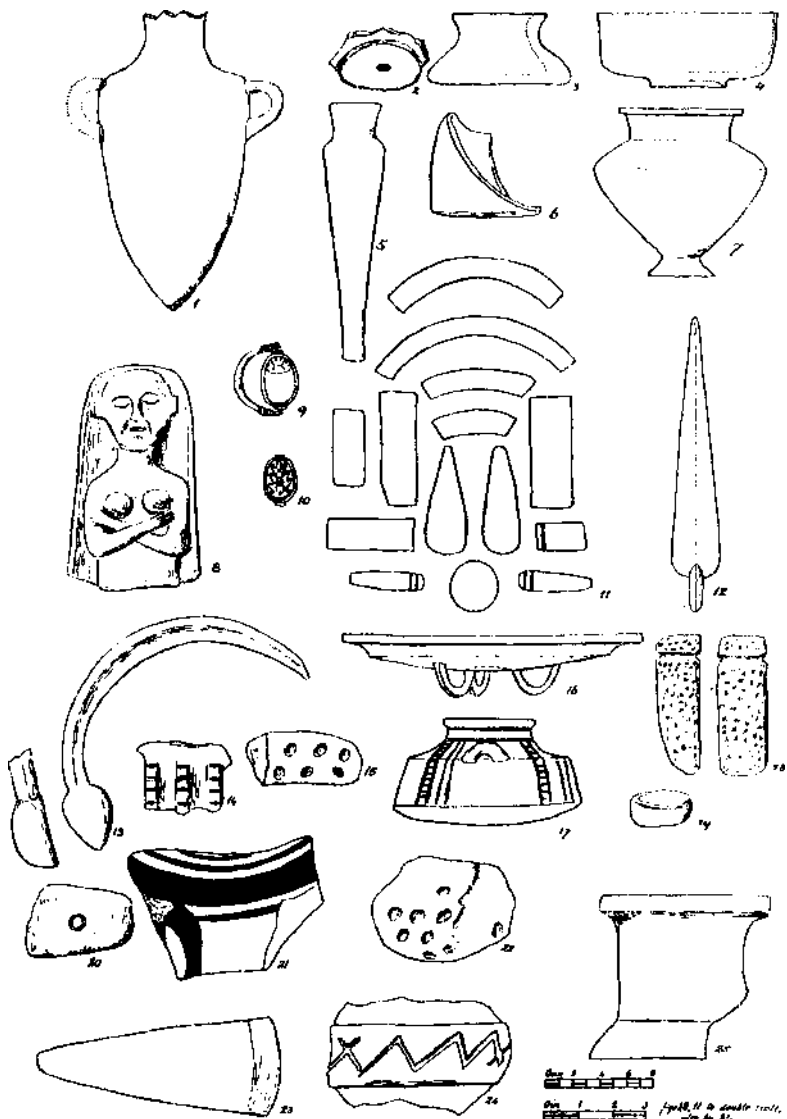

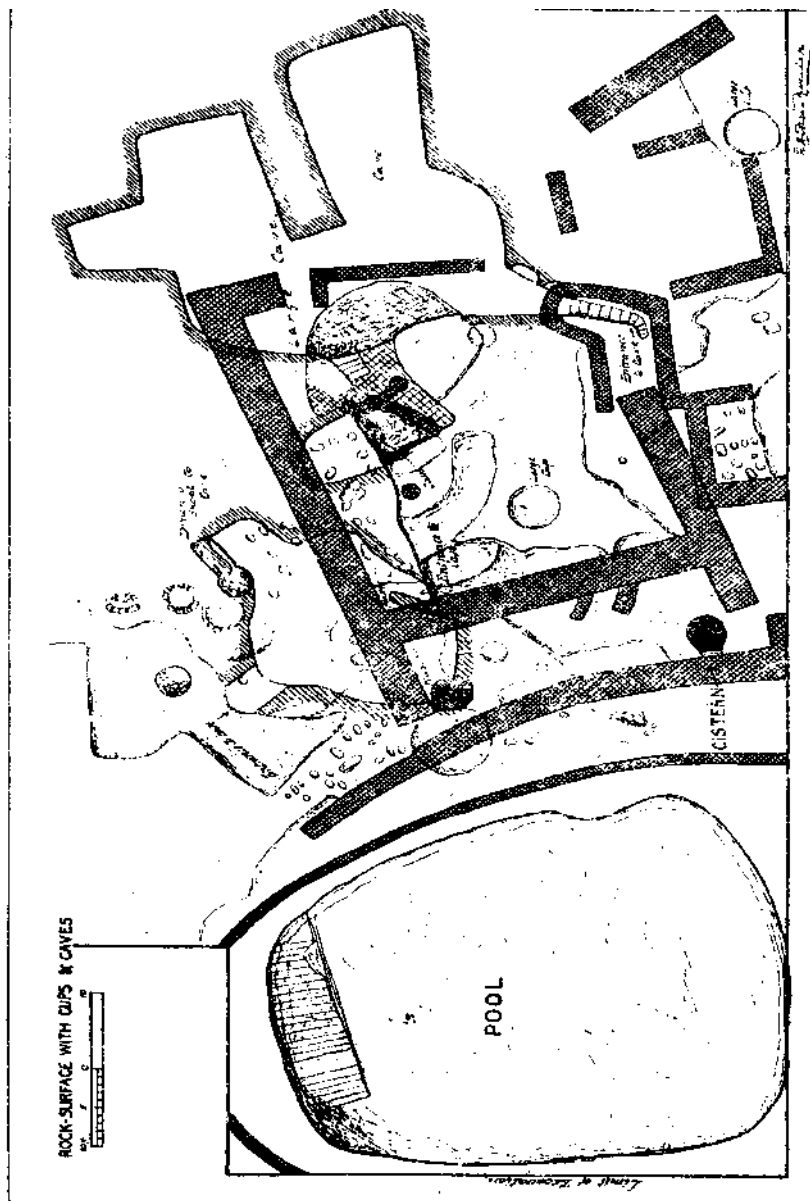





CONTENTS OF CAVE 271

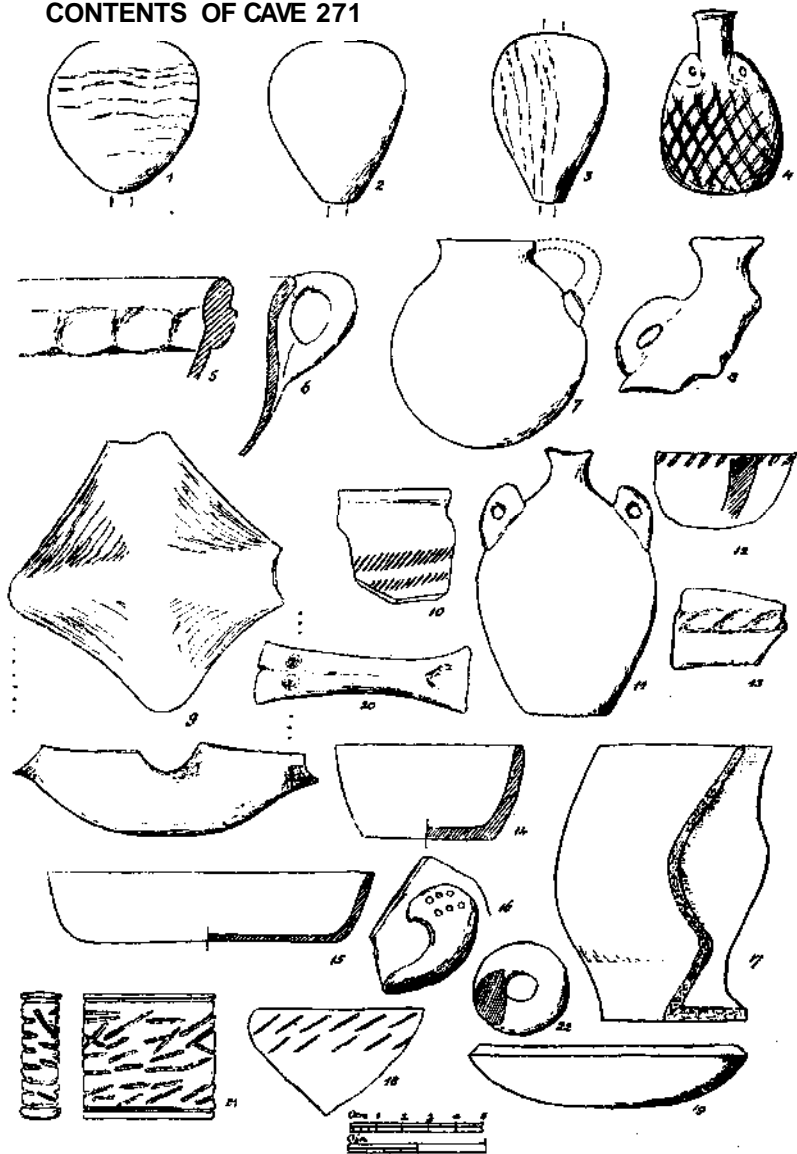

CONTENTS OF CAVES 27 I (12) & 30 III (5-7)

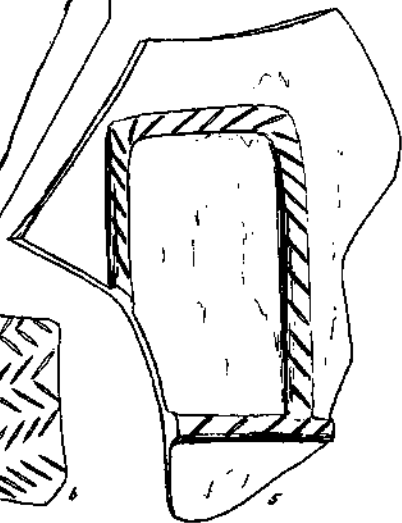
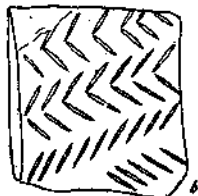
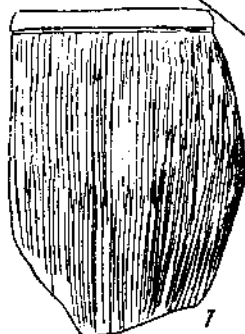
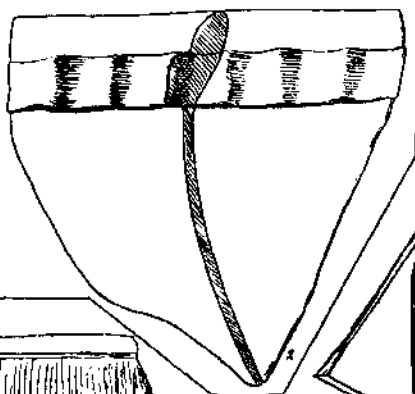
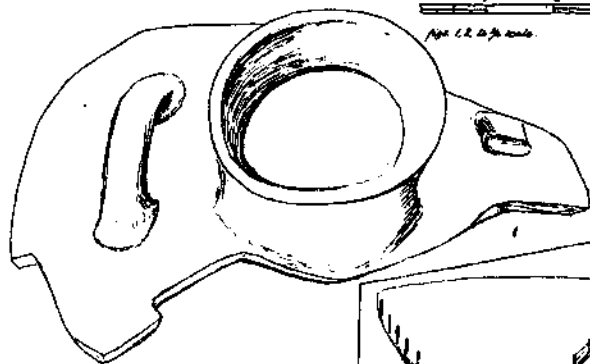



FIG. 3 •

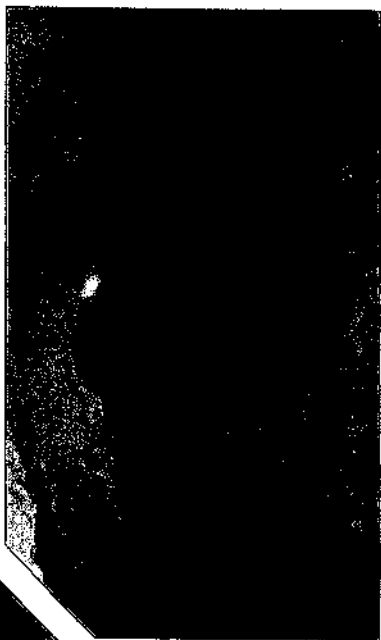

FIG. 4

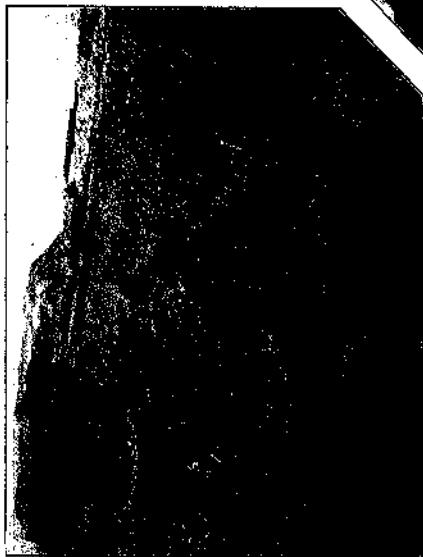
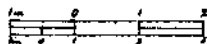

FIG. 5





POTTERY &c from *b.d.s.*, CAVE 28 II



Scale figures for 1, 2, 3, 4, 5, 6, 7, 8, 9, 10, 11, 12, 13, 14, 15, 16, 17, 18, 19, 20, 21, 22, 23, 24, 25, 26, 27, 28, 29, 30, 31, 32, 33, 34, 35, 36, 37, 38, 39, 40, 41, 42, 43, 44, 45, 46, 47, 48, 49, 50, 51, 52, 53, 54, 55, 56, 57, 58, 59, 60, 61, 62, 63, 64, 65, 66, 67, 68, 69, 70, 71, 72, 73, 74, 75, 76, 77, 78, 79, 80, 81, 82, 83, 84, 85, 86, 87, 88, 89, 90, 91, 92, 93, 94, 95, 96, 97, 98, 99, 100

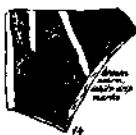
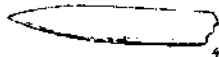
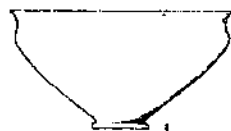
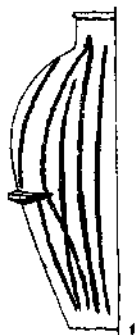
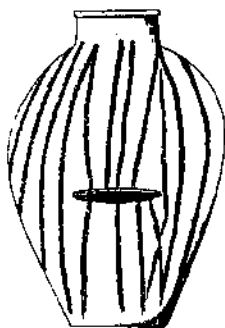
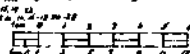







SCARABS &c. from CAVE 28 II

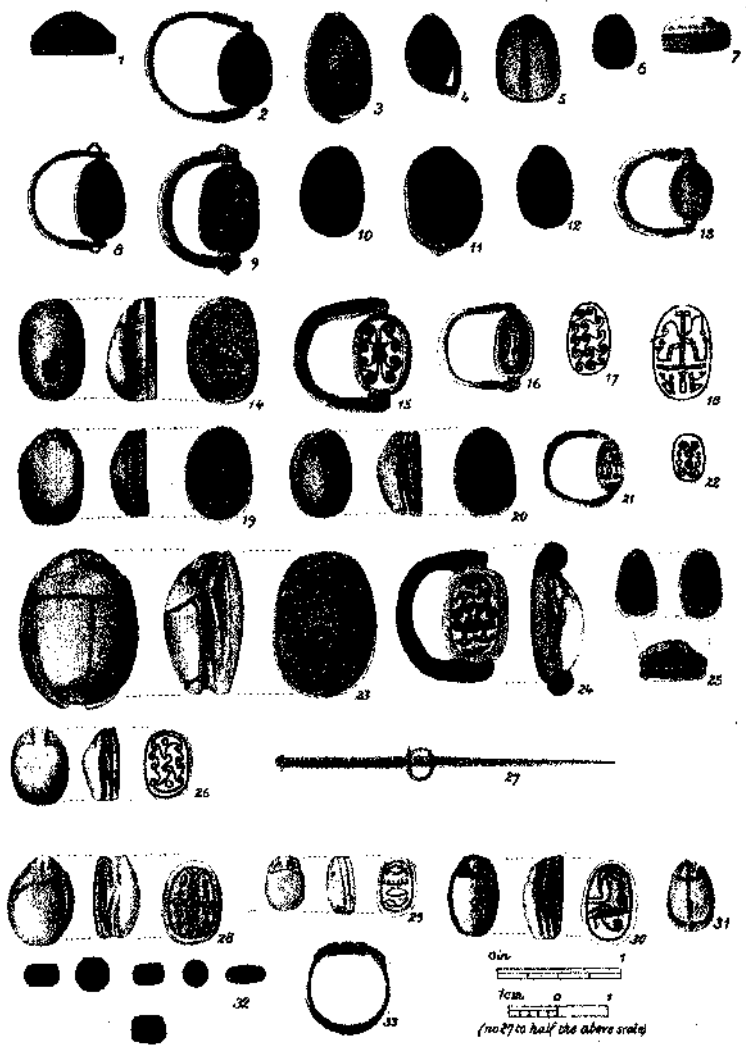

POTTERY &c. from CAVE 28 II



1—(figs 1-5) — diam 2 1/2  
 2—(figs 6-9, 12, 13, 17-20) — diam 7  
 3—(figs 10, 11, 14, 16) — diam 1



Plate xxx vii

POTTERY

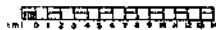
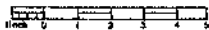

*Robertson*





POTTERY

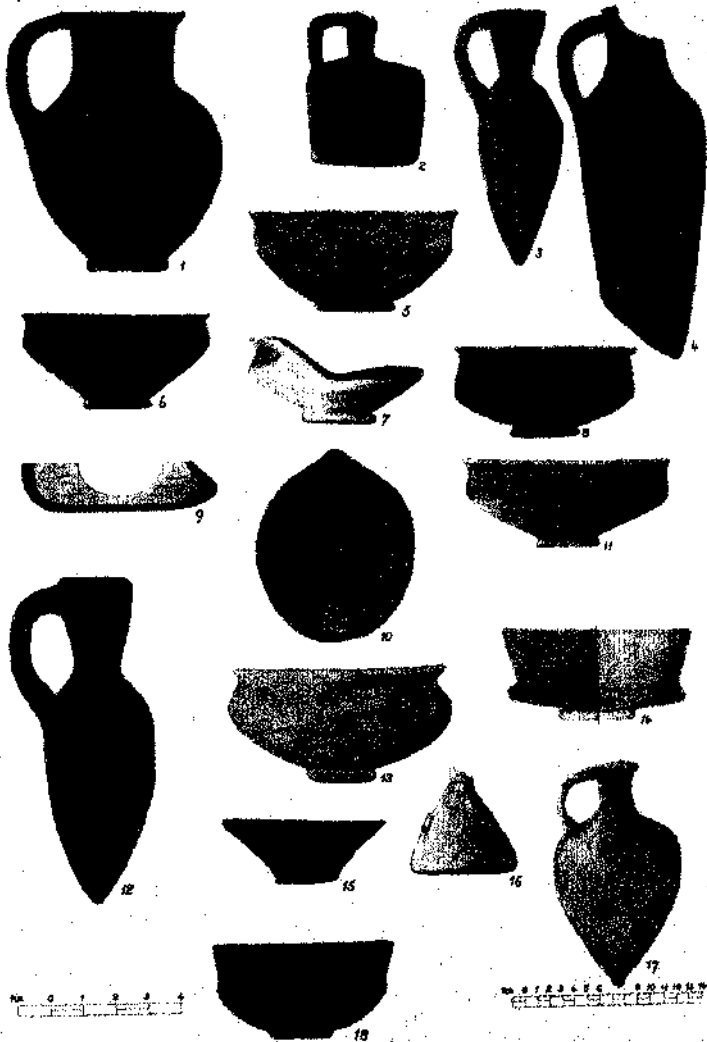

POTTERY

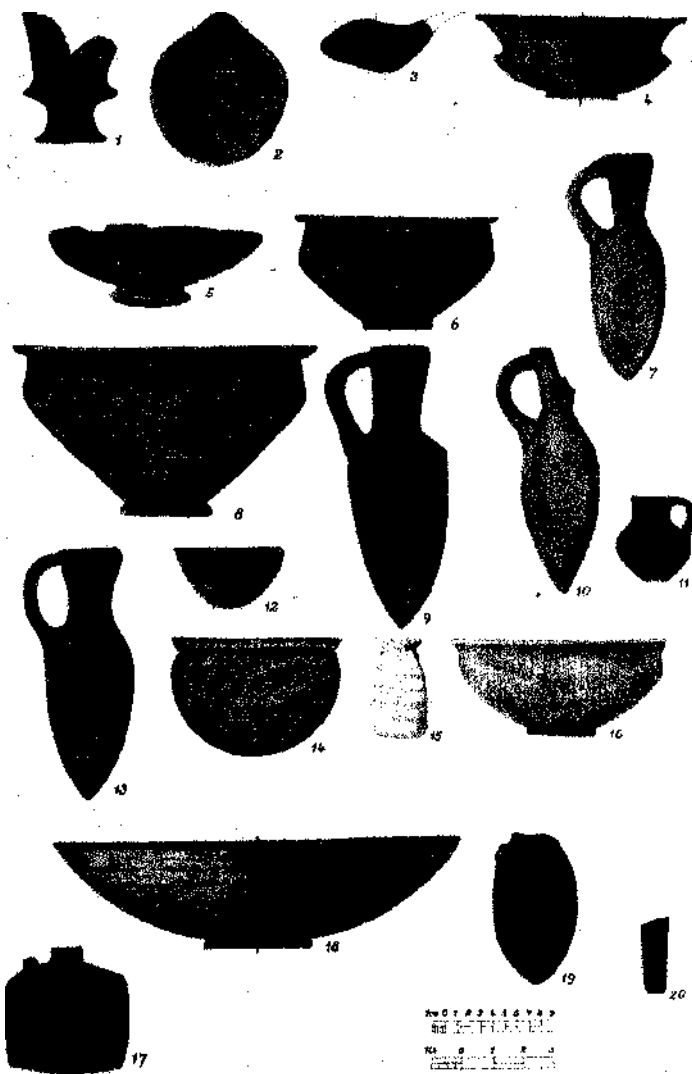

№ 0 1 2 3 4 5 6 7 8 9 0  
№ 0 1 2 3 4 5 6 7 8 9 0  
№ 0 1 2 3 4 5 6 7 8 9 0





POTTERY

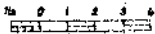

The UNIVERSITY OF CHICAGO PRESS

# POTTERY

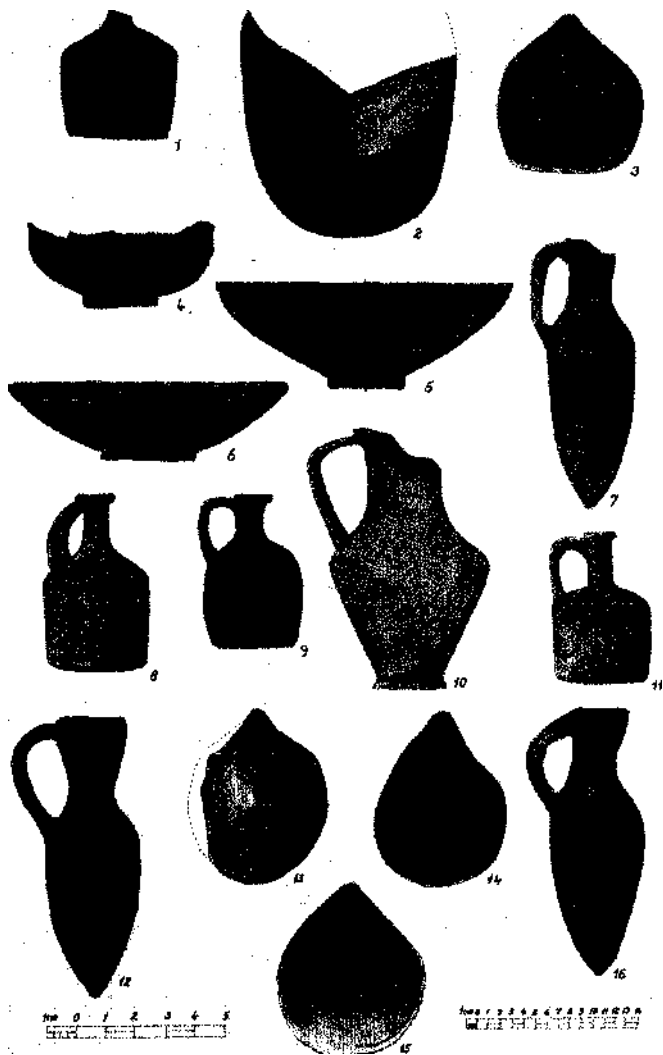



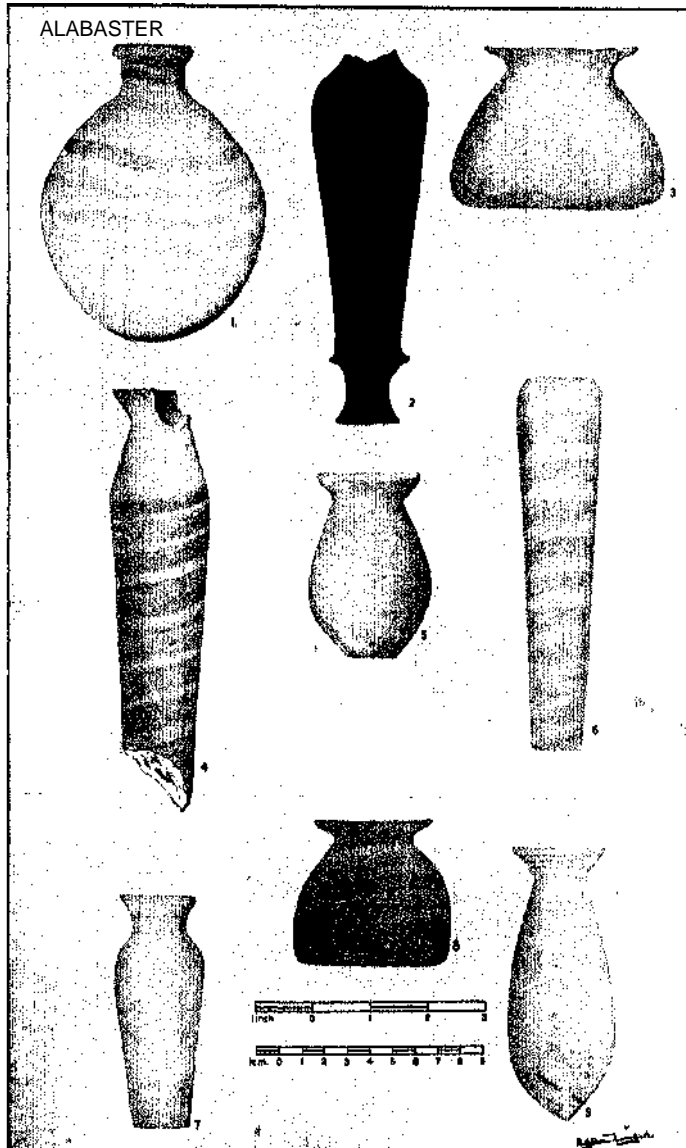





LATER OBJECTS

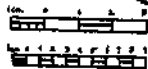
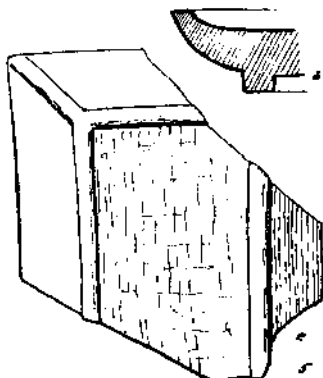
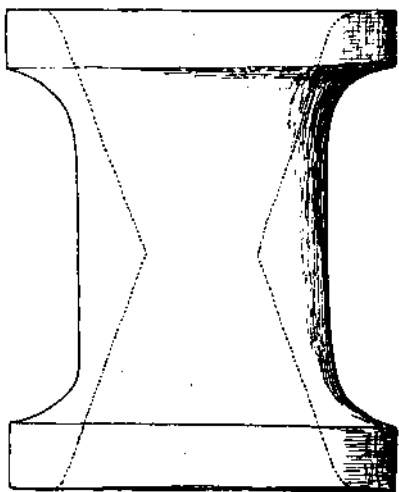
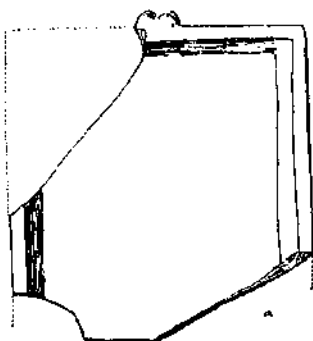
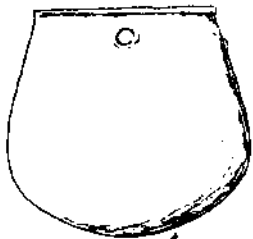

*Robertson*

CONTENTS OF CAVE 30 II

*figs 4, 5, 10 double, figs 14, 15 quadruple stroke*

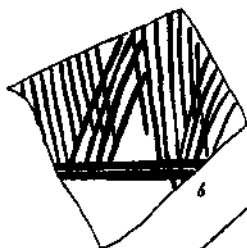
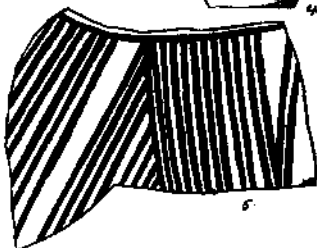
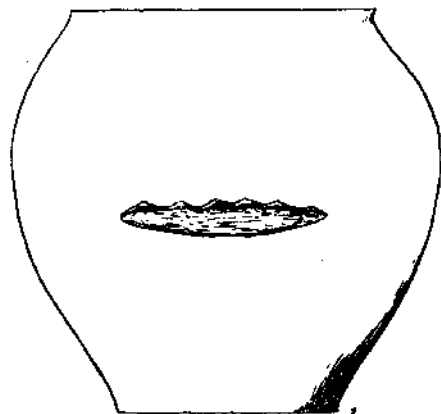

CONTENTS OF CISTERN, S. END TRENCH 30

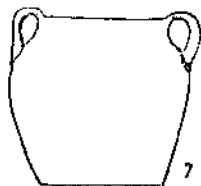

CONTENTS OF CISTERN IN CAVE 34 I

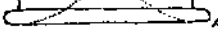
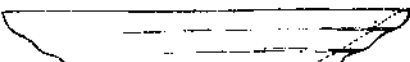



Plate xlv

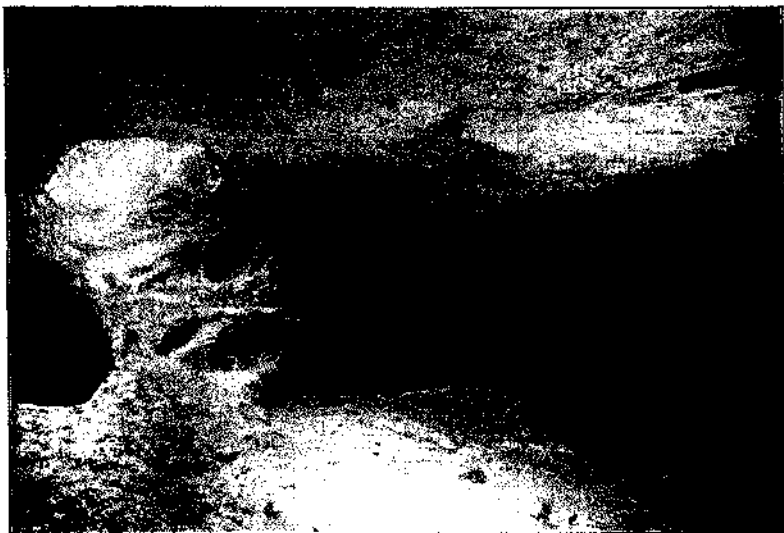

FIG. 1



FIG. 2

INTERIOR OF CAVE 30 IV, SHEWING POSITION OF GRAFFITI





GRAFFITI IN CAVE 30 IV

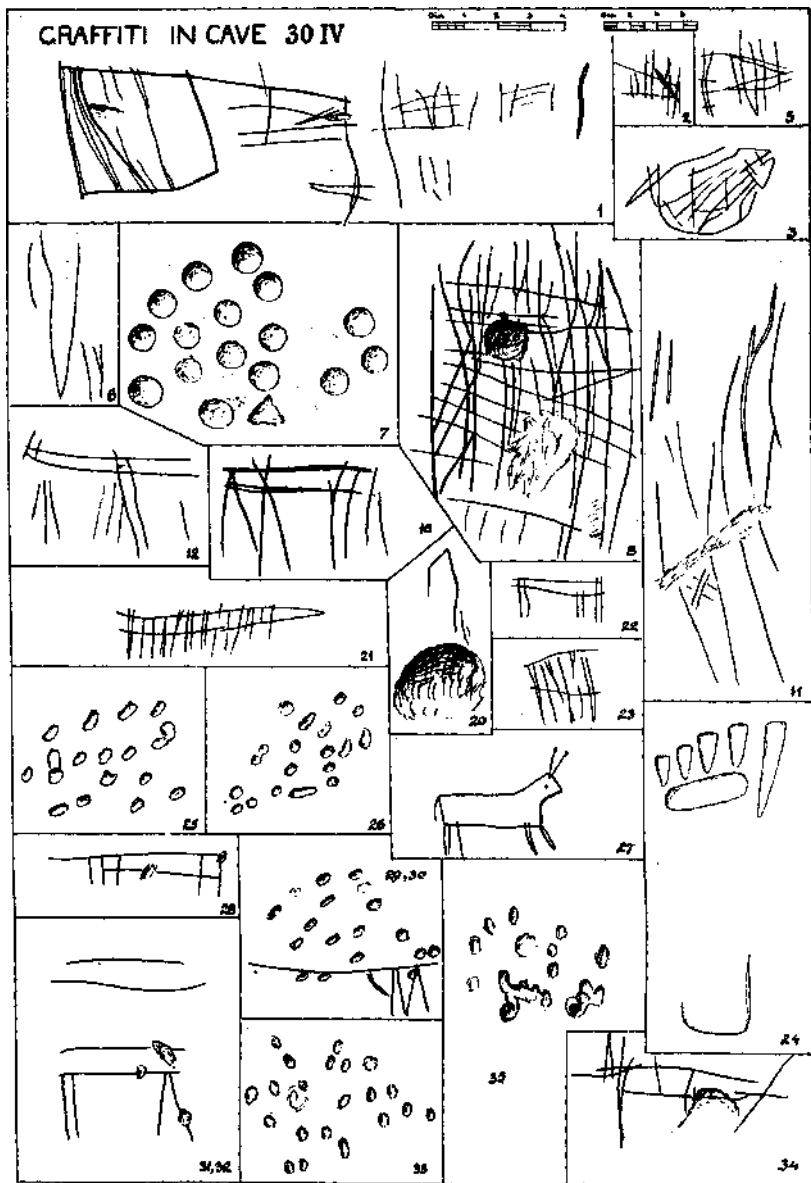

CRAFFITI IN CAVE 30 IV

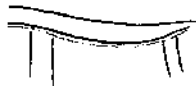
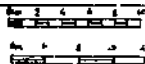

37-39

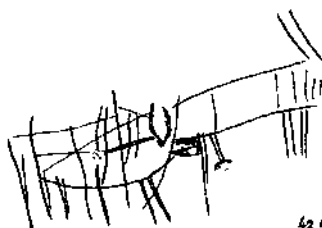

42, 43



44



46



52

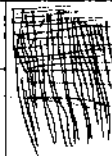

53

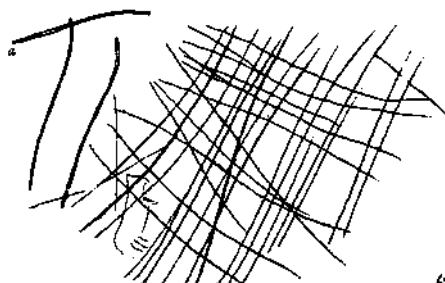

45



54

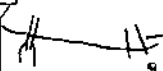

51

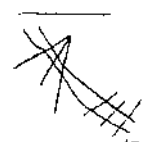

47

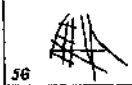

56



55



57



58



60





GRAFFITI IN CAVE 30.IV



48-50

Clay	1	2	3	4	5	6	7	8	9	10
1										
2										
3										
4										
5										
6										
7										
8										
9										
10										



61



62



59

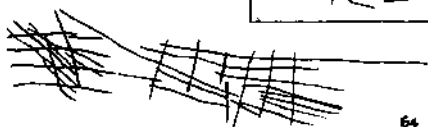

64



65



66

FROM CAVE 7 II

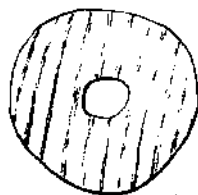
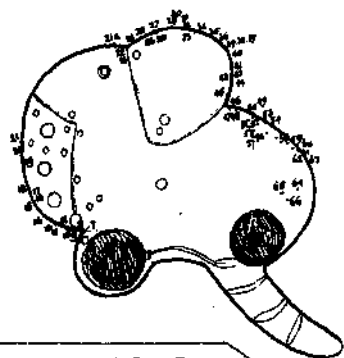

FROM CAVE 6 I

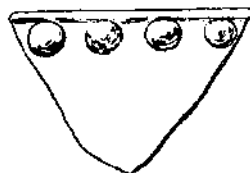

HOUSE PLANS

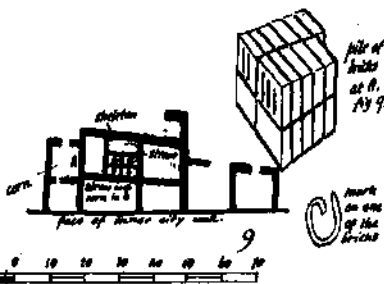
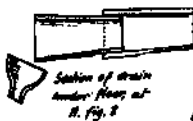
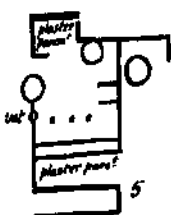
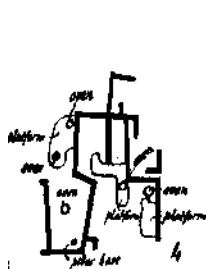
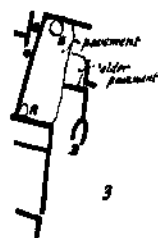
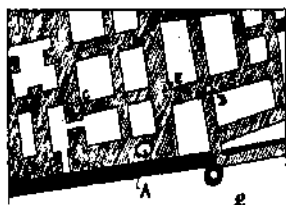
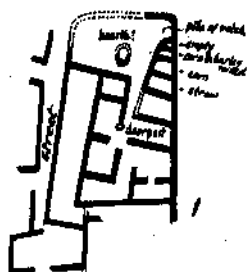





# ROMAN BATH YERDEH



OBJECTS

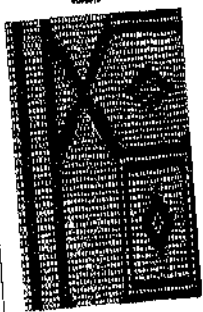

DETAIL OF ARCADE  
Scale 1/4" = 1'-0"

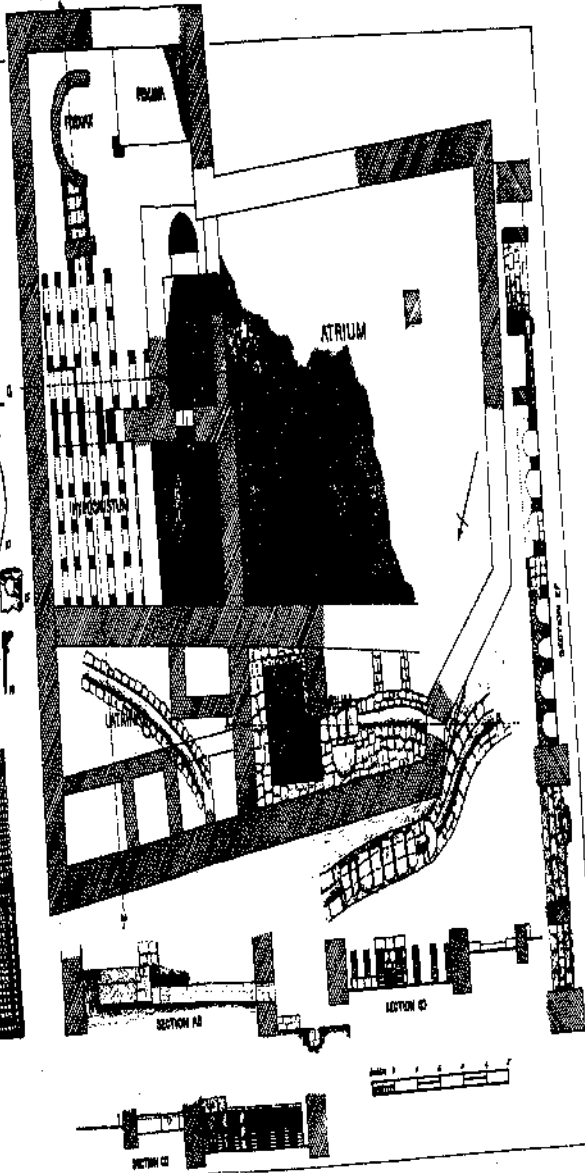



# EXCAVATION OF CEZER

## PLAN OF THE NORTH EAST GATE

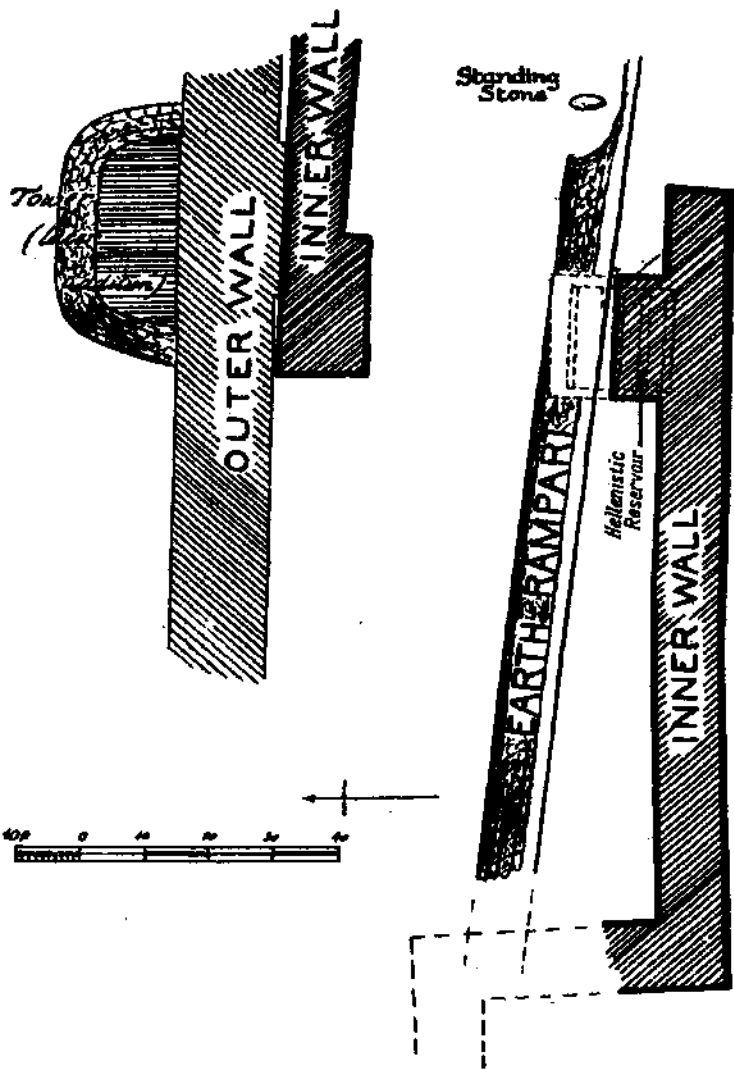





# CEZER: THE WATER-PASSAGE

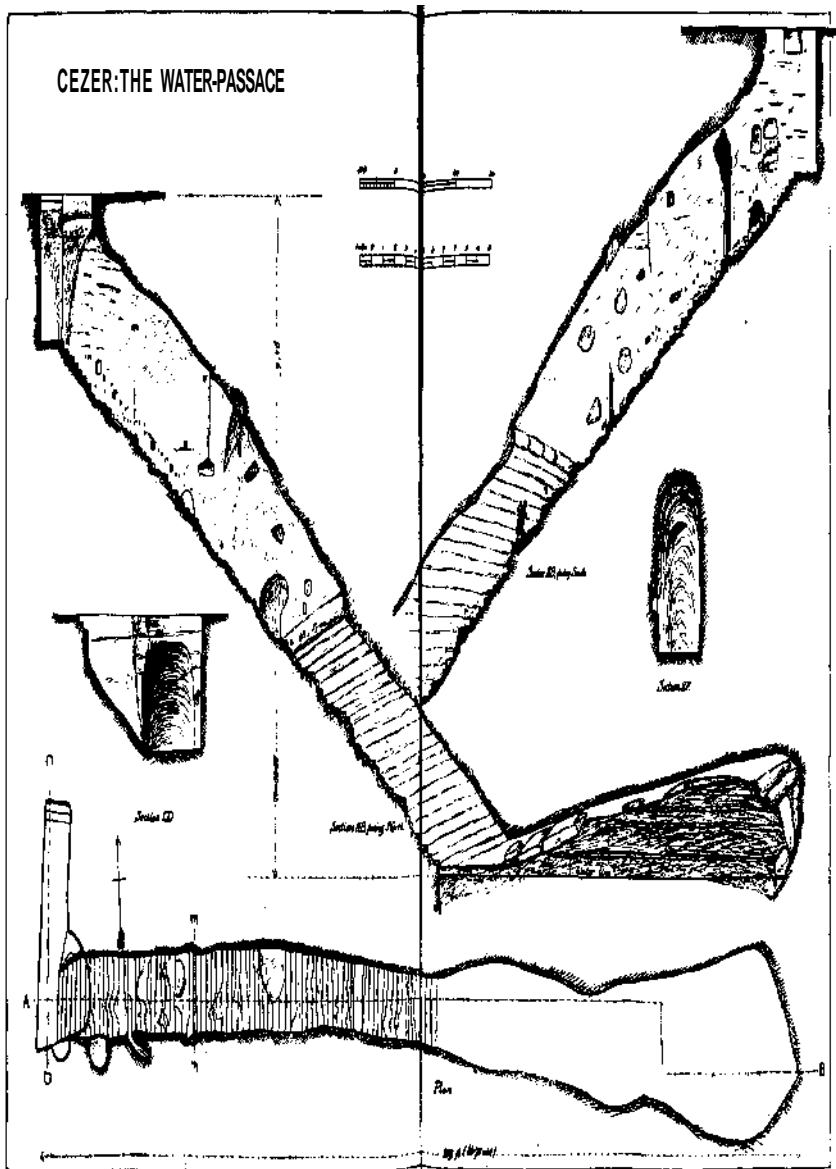





# EXCAVATION OF CEZER FRAGMENTS OF MOULINGS

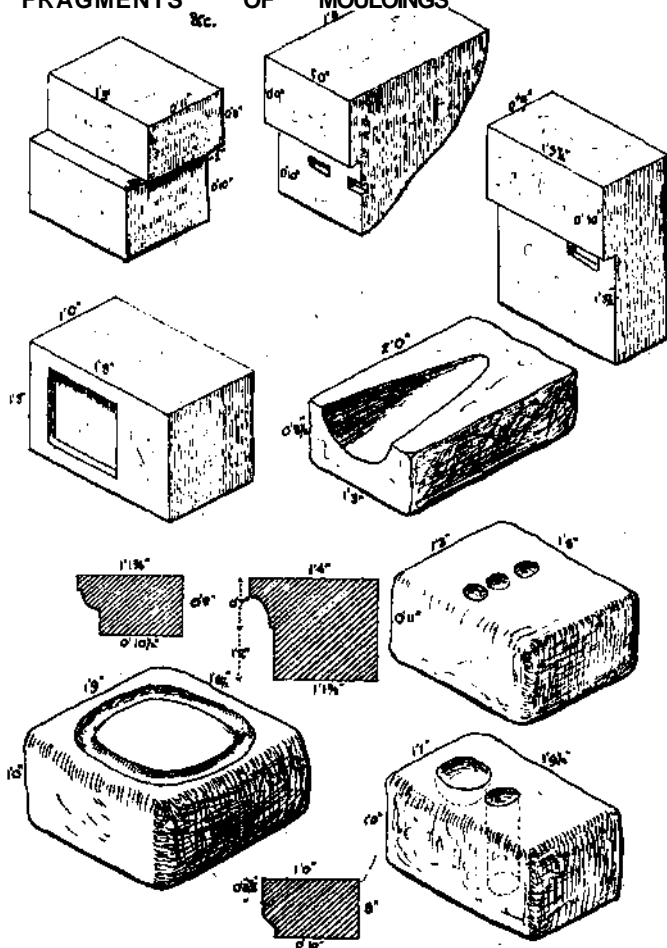

R.A. Smith

# RESERVOIR

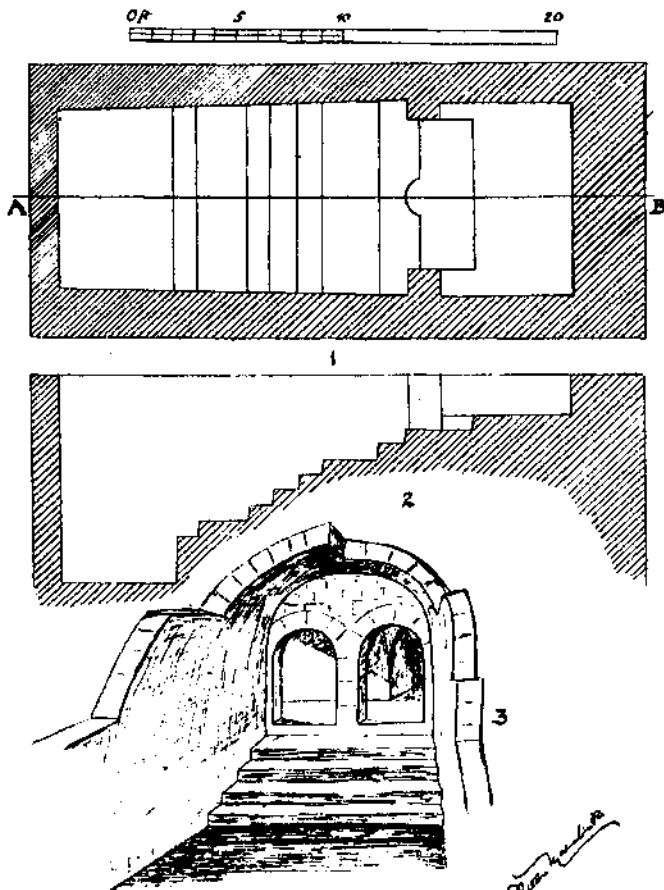

1. Plan of no. 12 Section, on line AB

3. Restoration of no. 11





"PHILISTINE" TOMB DEPOSITS

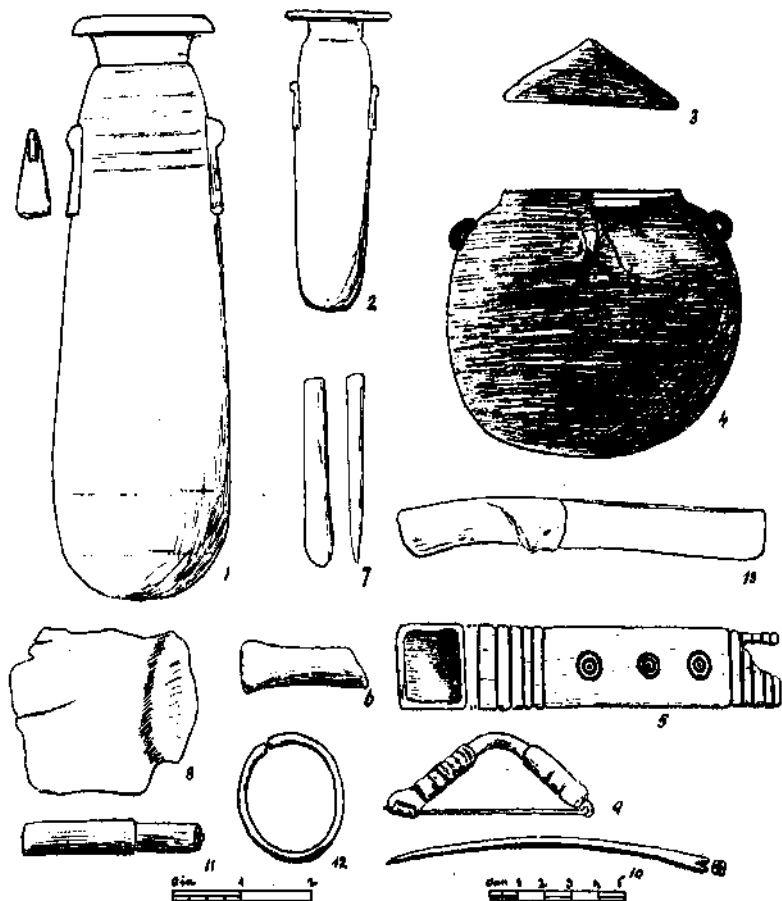

TOMB PLANS

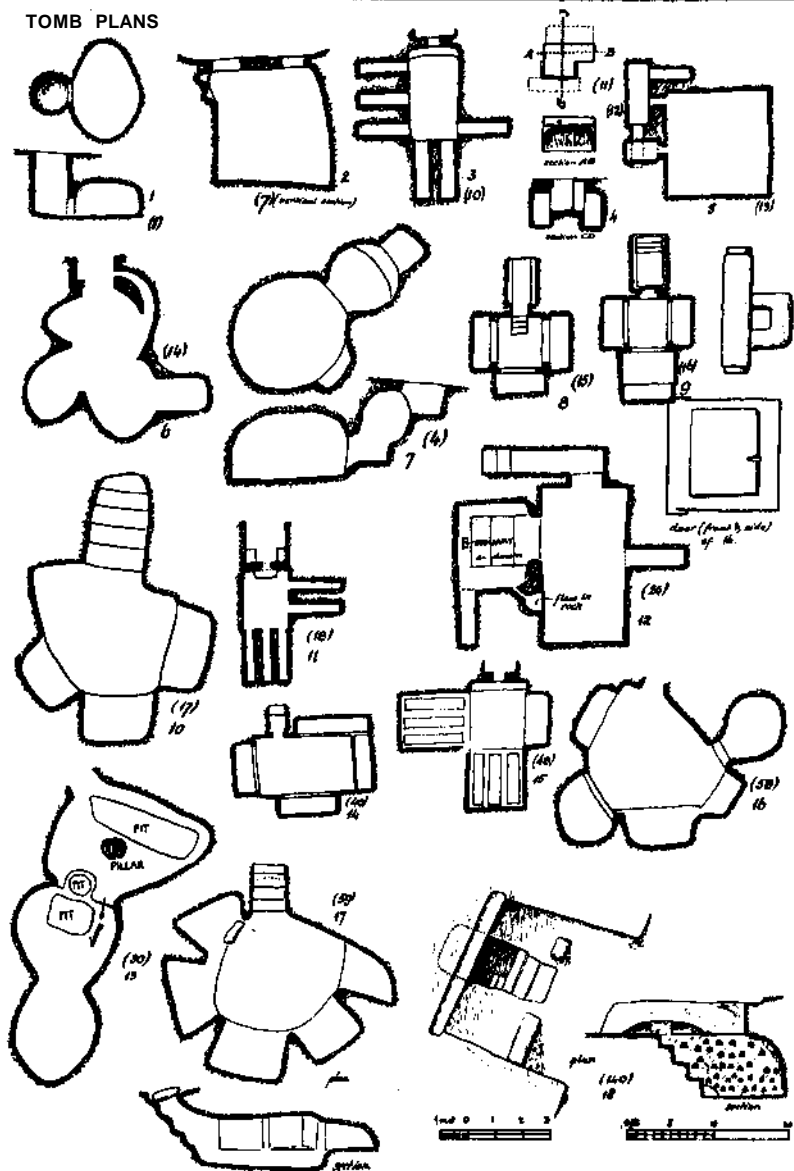

TOMB PLANS

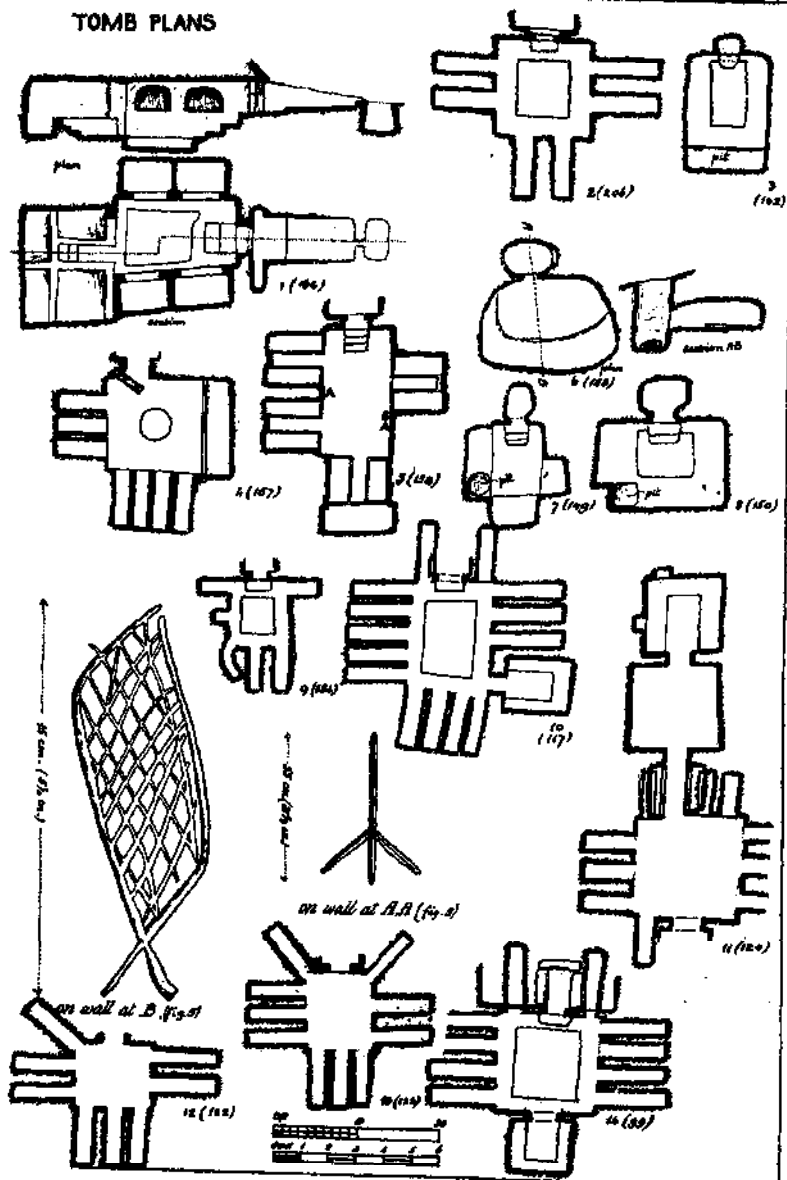

TOMB - PLANS

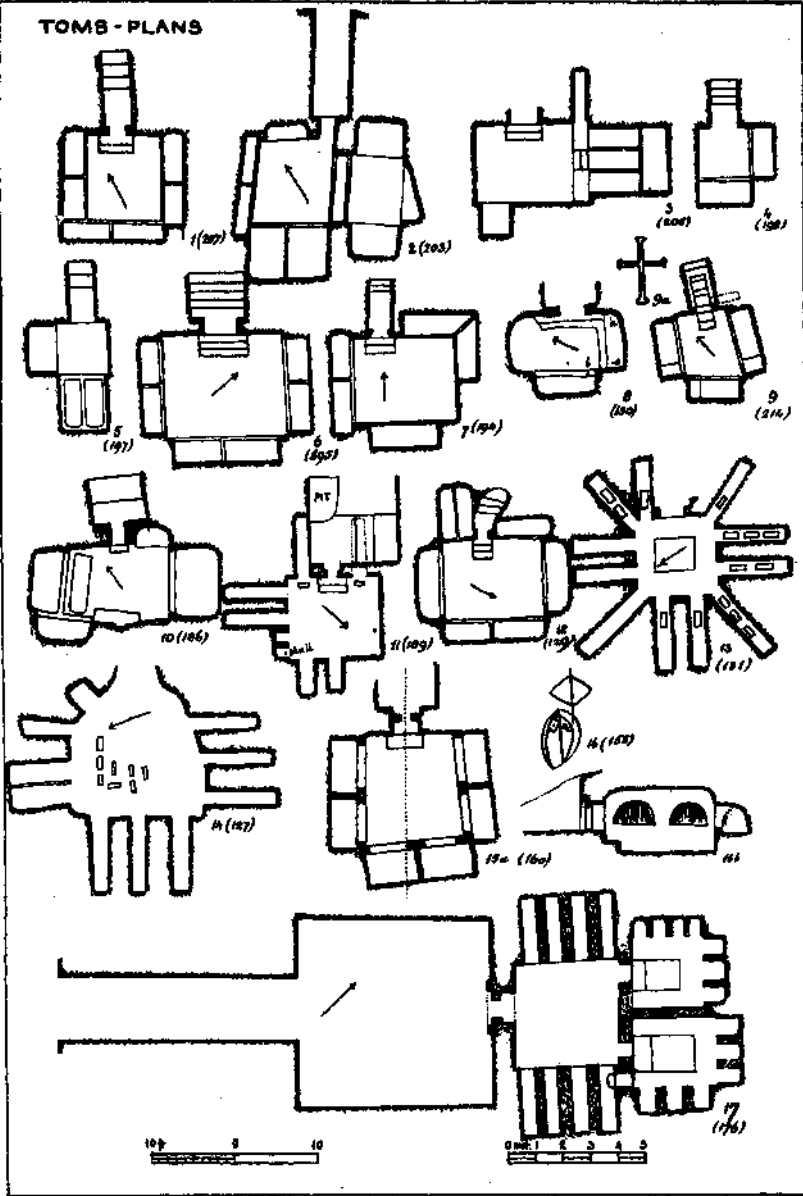





TOMB PLANS

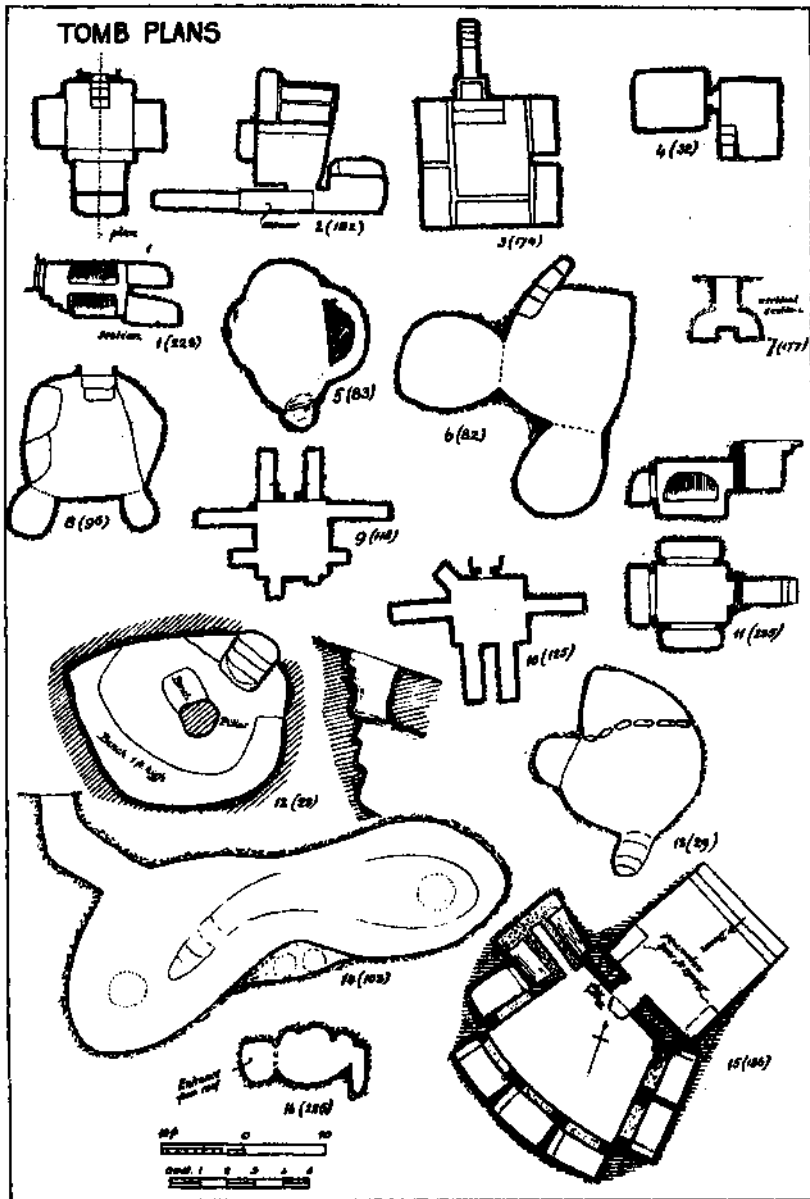

TOMB No 1

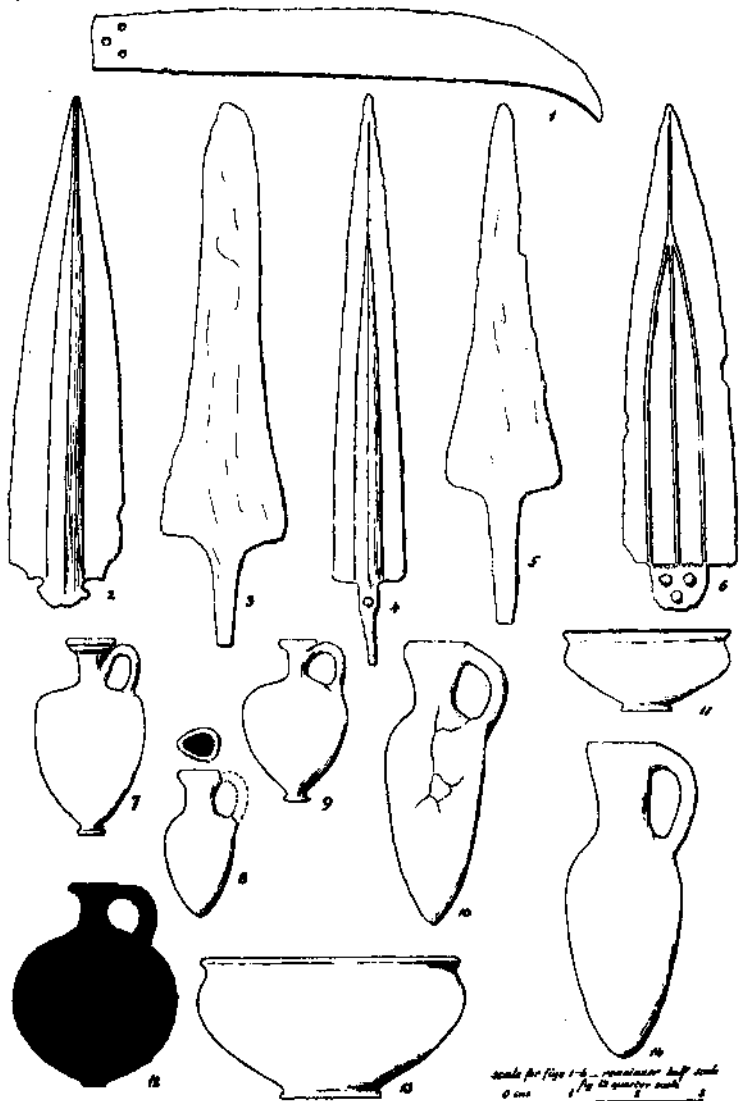

scale for figs 1-6... remainder half scale  
 0 cm 1/2 in

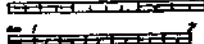





## TOMB No 1

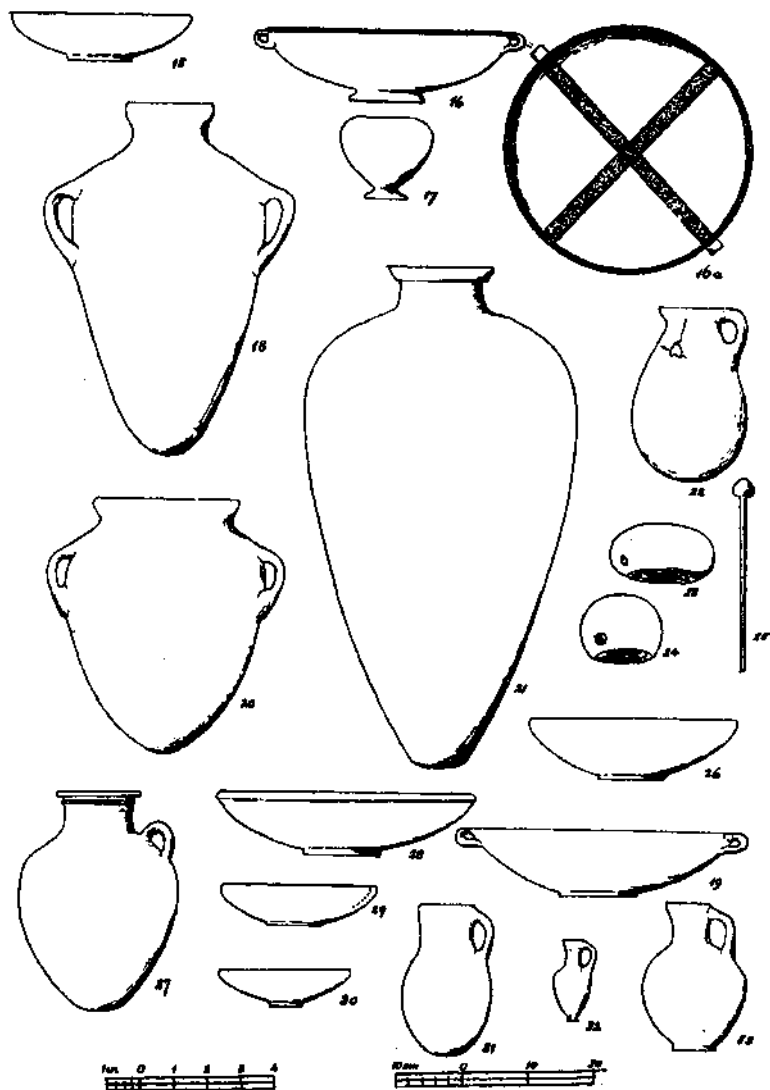

TOMB No 1

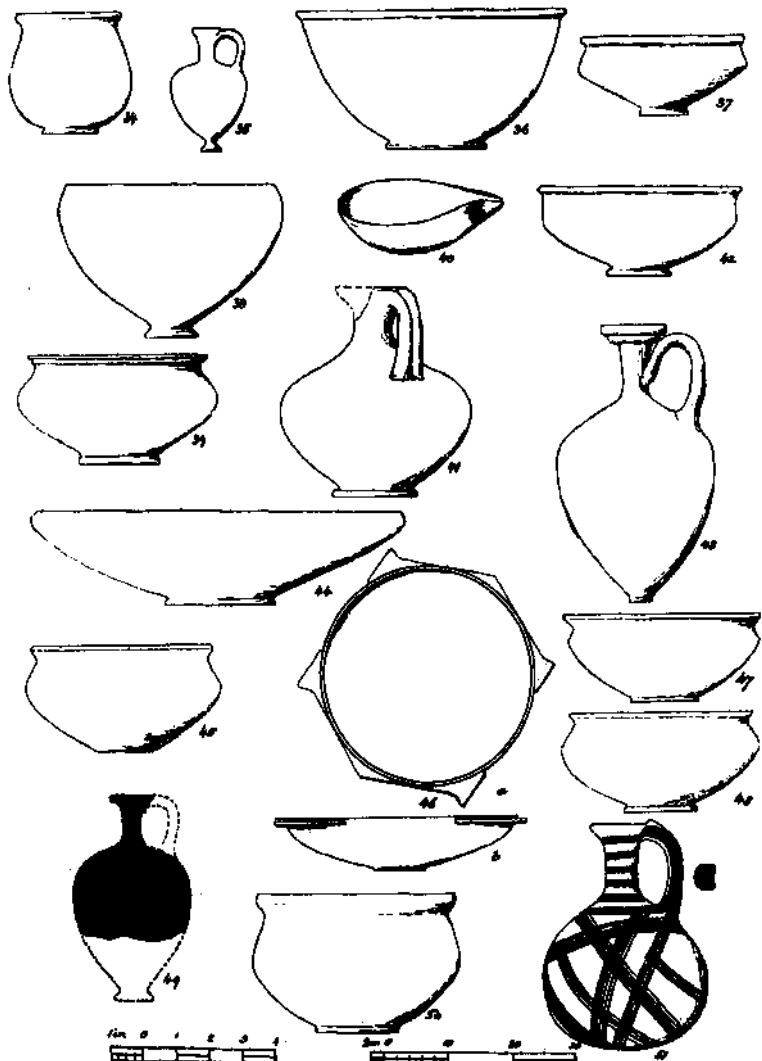





TOMB No I

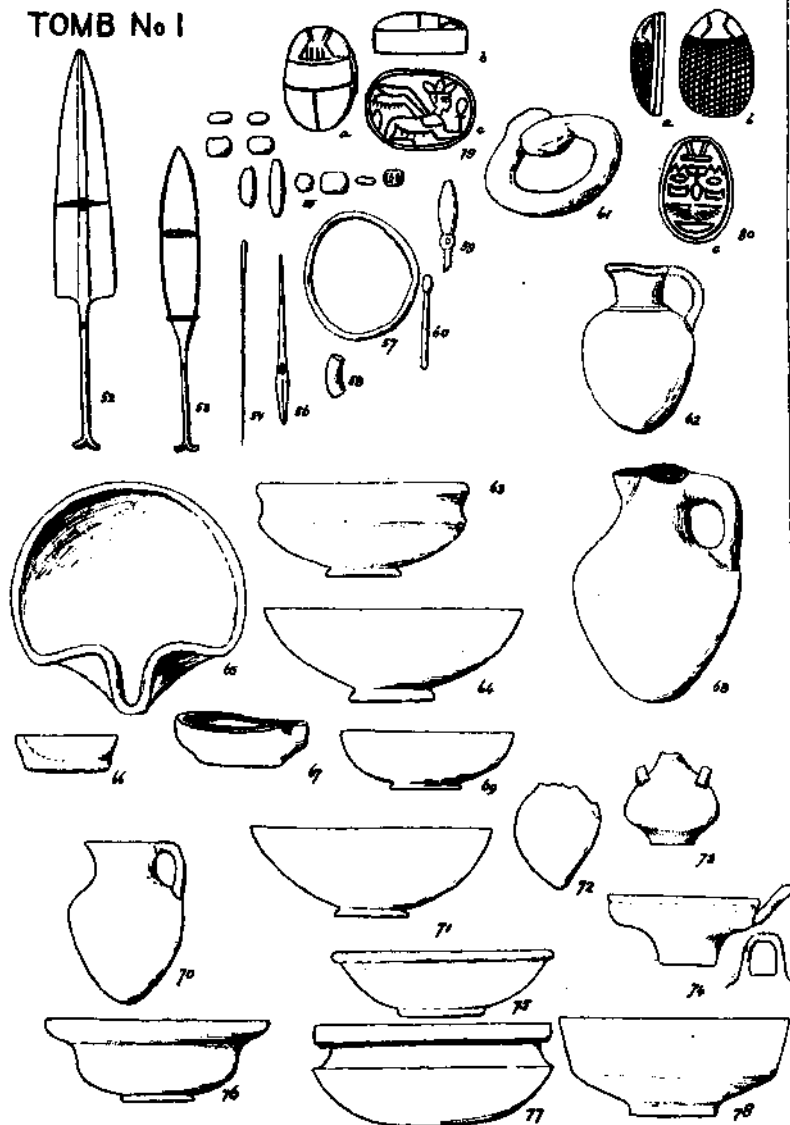
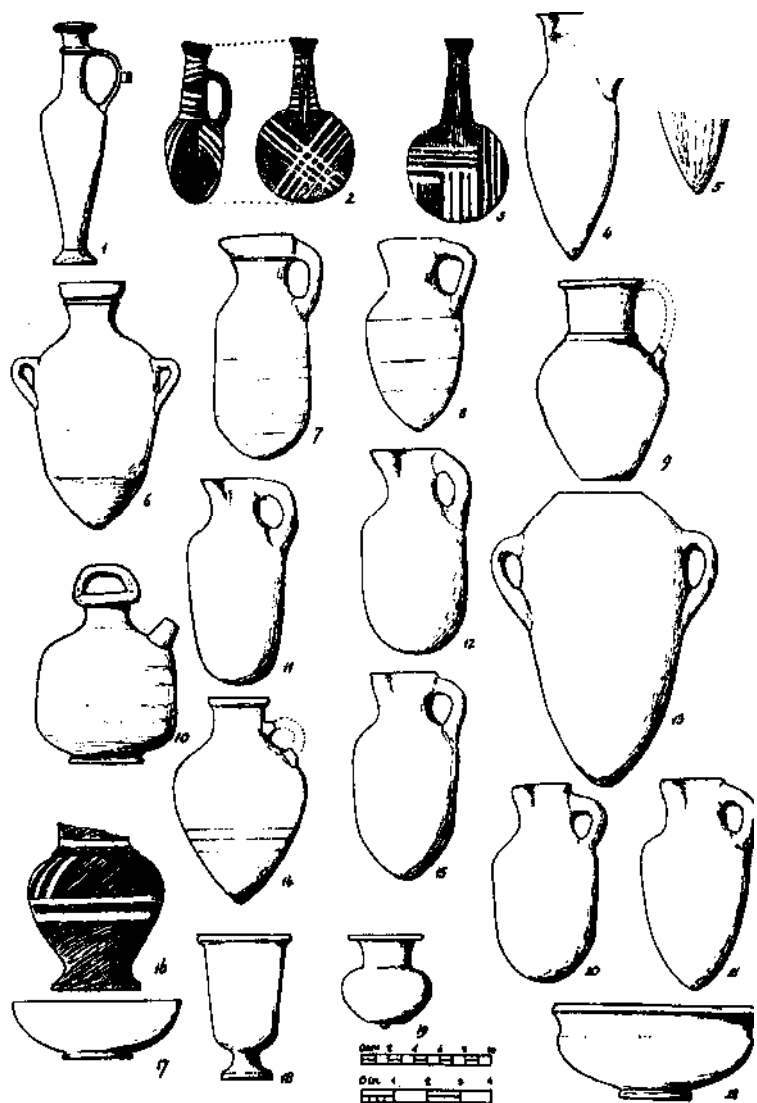

Fig. 51 to 54 four times each, 55 to 58, 60, 61, 62, 63, 64, 65, 66, 67, 68, 69, 70, 71, 72, 73, 74, 75, 76, 77, 78 to half scale.

TOMB No 7







TOMB No 7

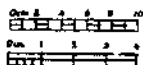
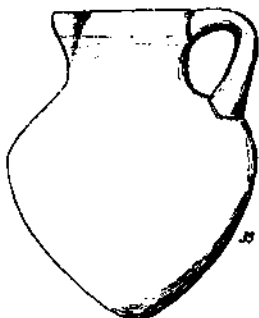

TOMB No 7

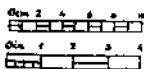
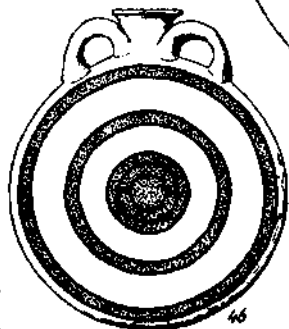
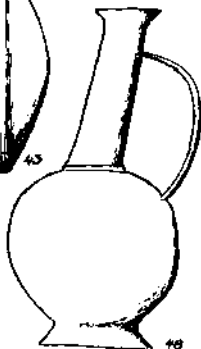
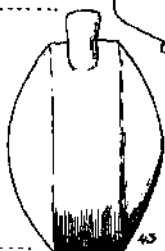
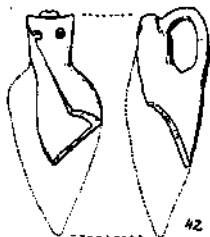
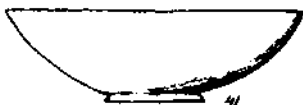





Plate \Ixvii

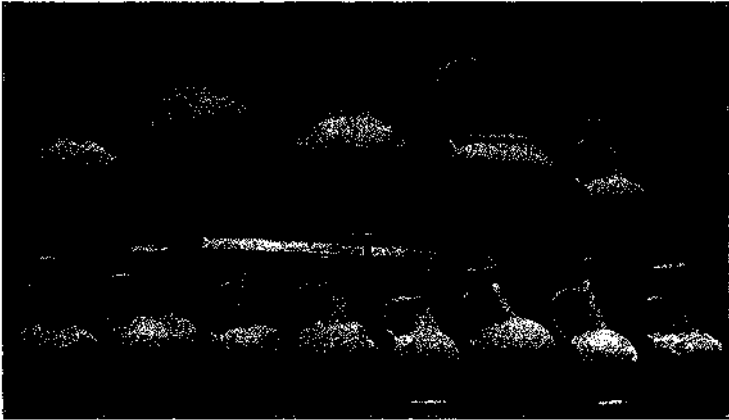

FIG. 1

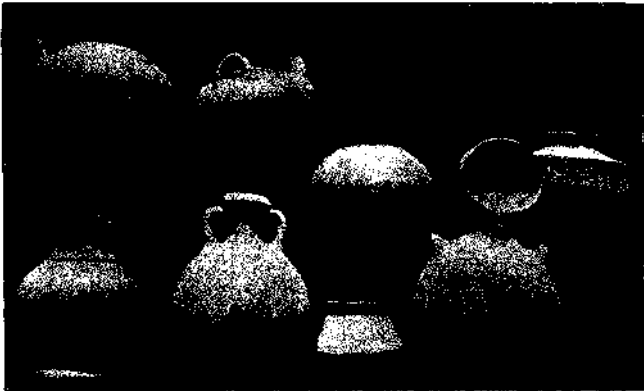

FIG. 2



FIG. 3

Plate lxviii



FIG. 1



FIG. 2

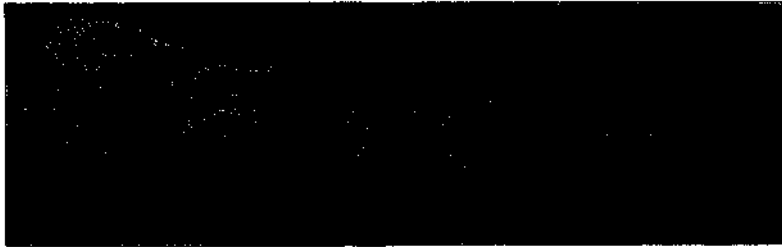

FIG. 3

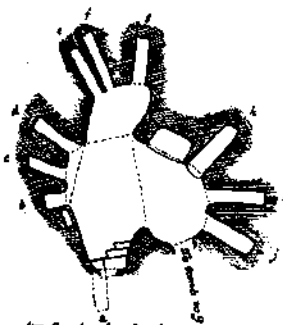
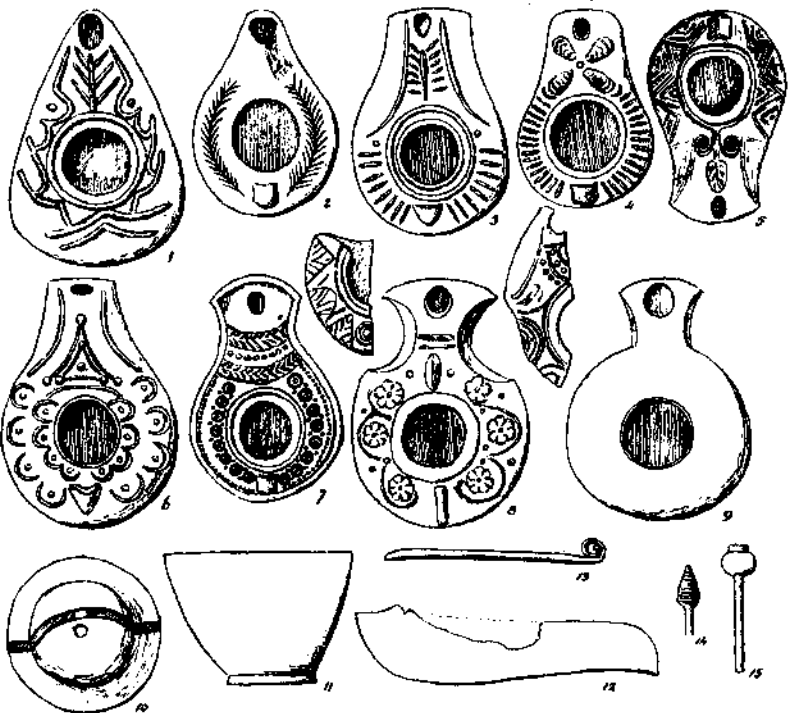

FIG. 4





TOMB No 8



TOMB No 9

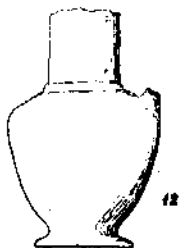
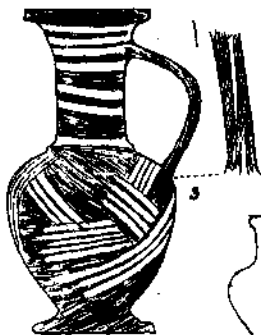

for scenes on wall plate







TOMB No 9

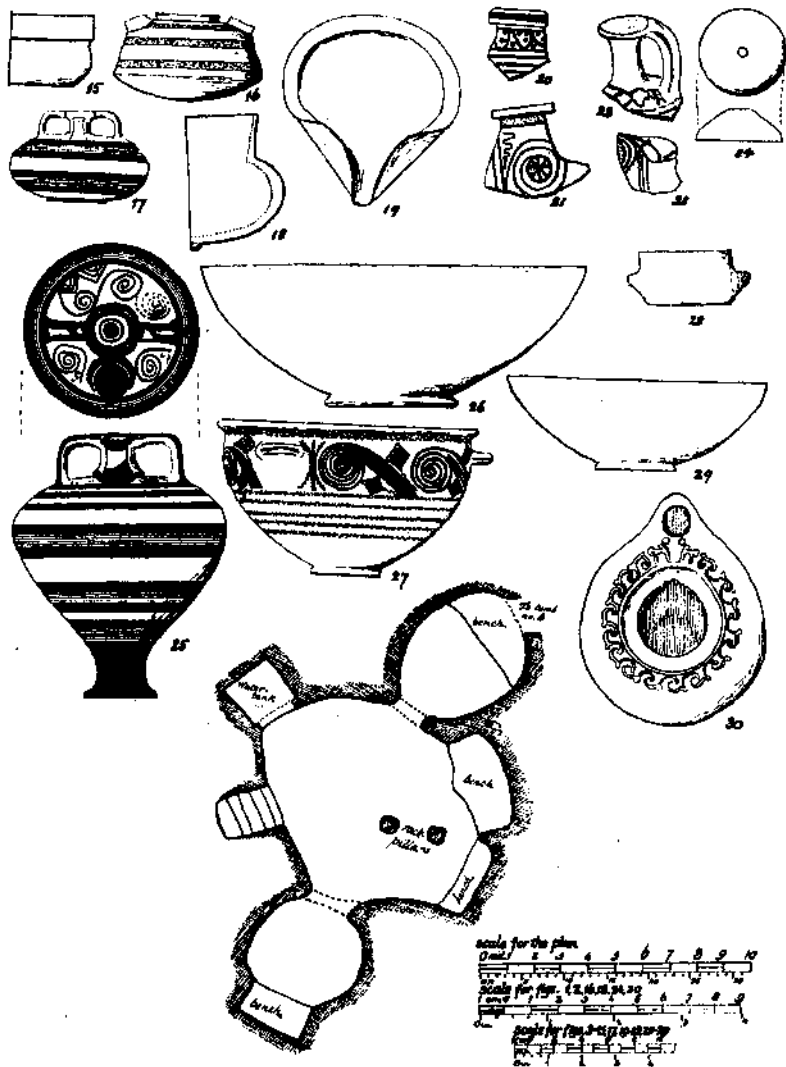

TOMB DEPOSITS

No. 18

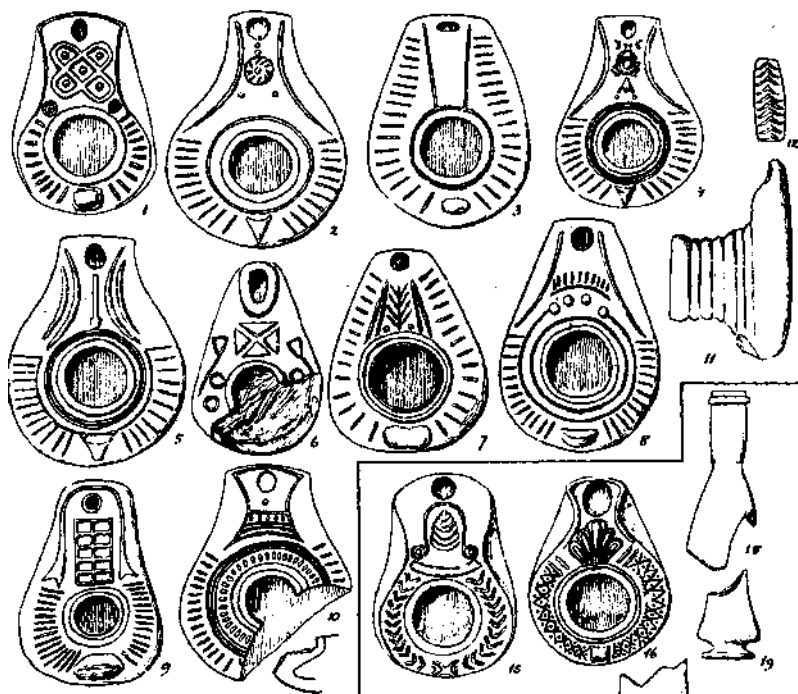

No. 23

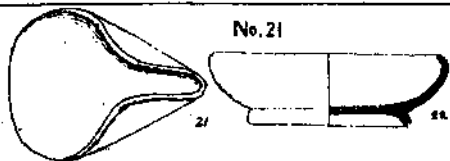
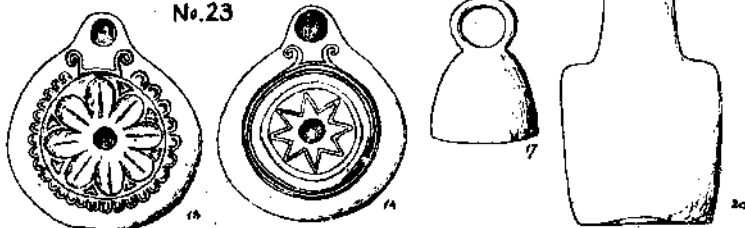

No. 21

No. 77



Scale 1 2 3 4 5  
 6 7 8  
 figs 21, 22  
 to half scale

TOMB No. 28

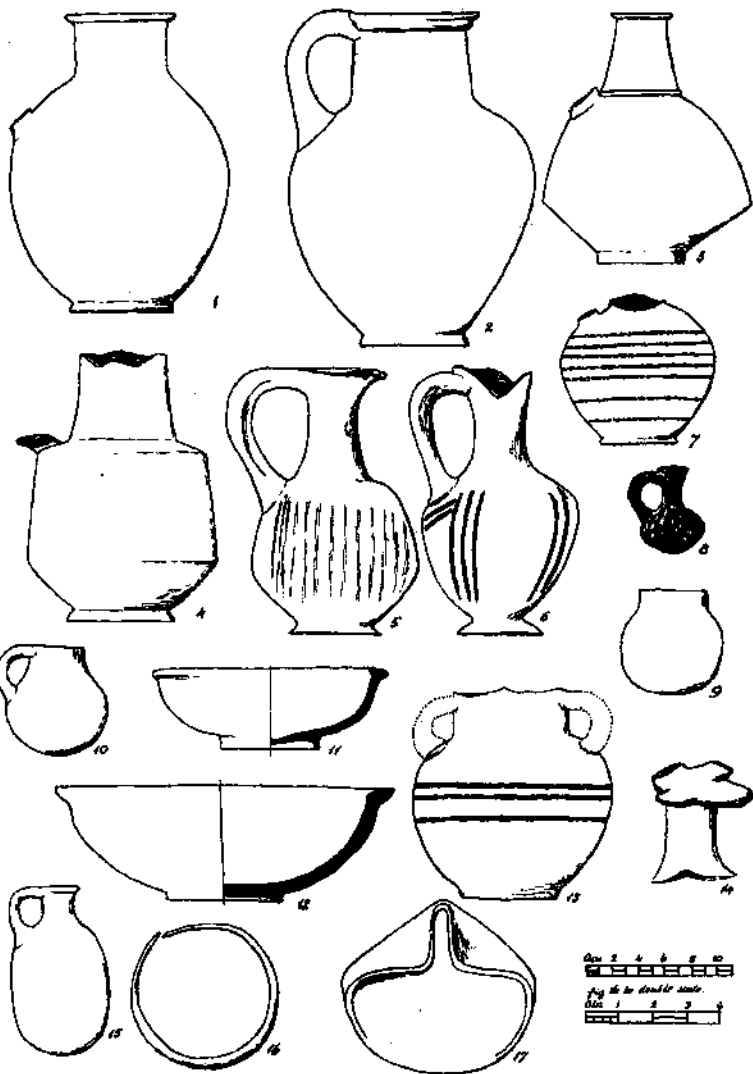

TOMB No. 30

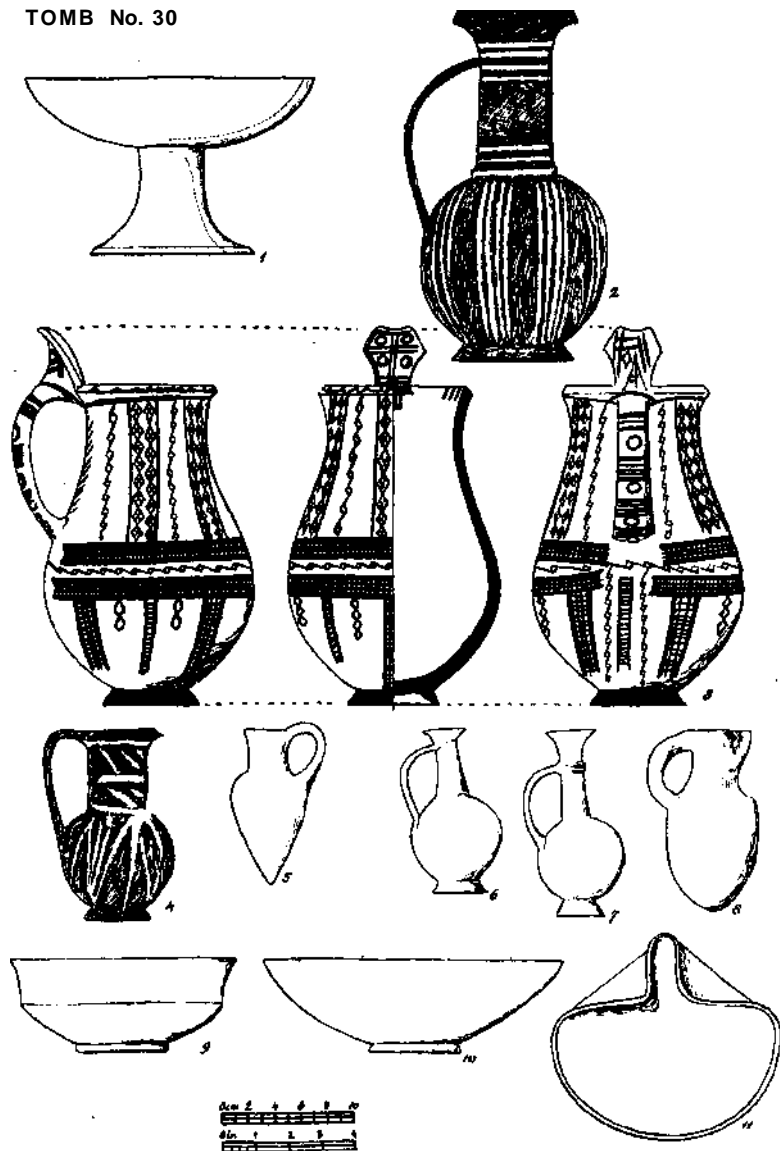





TOMB No. 30

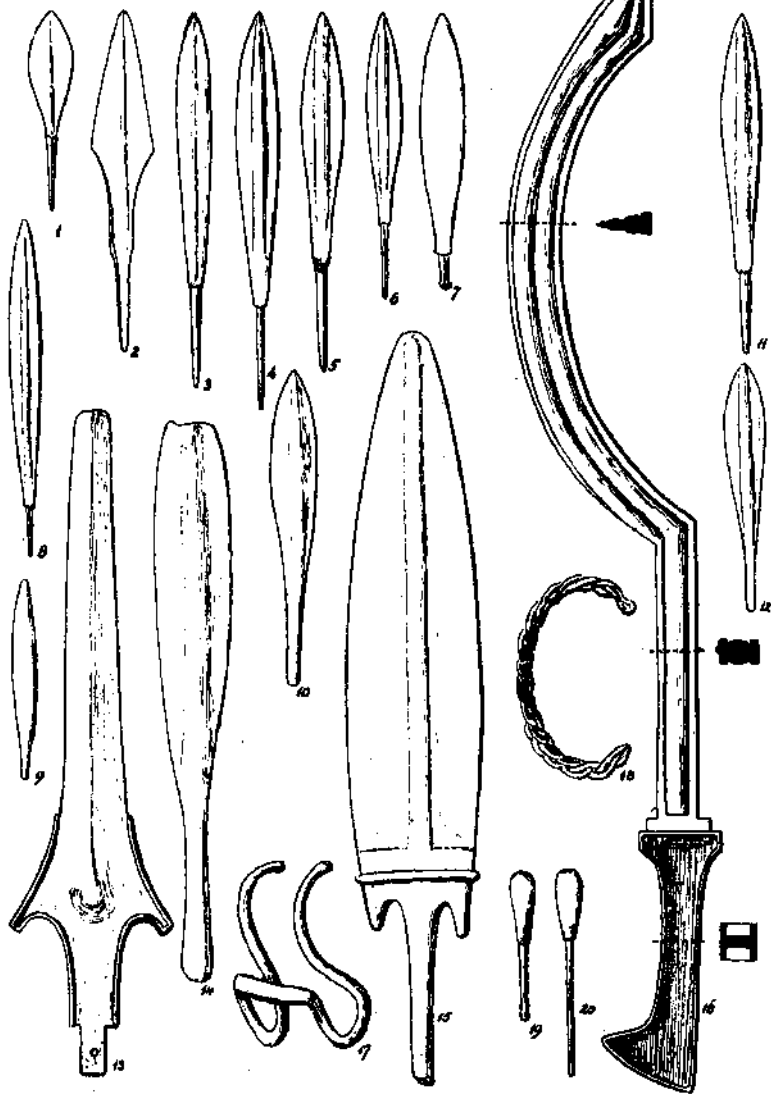
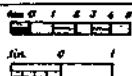
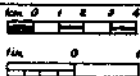

TOMB No 31

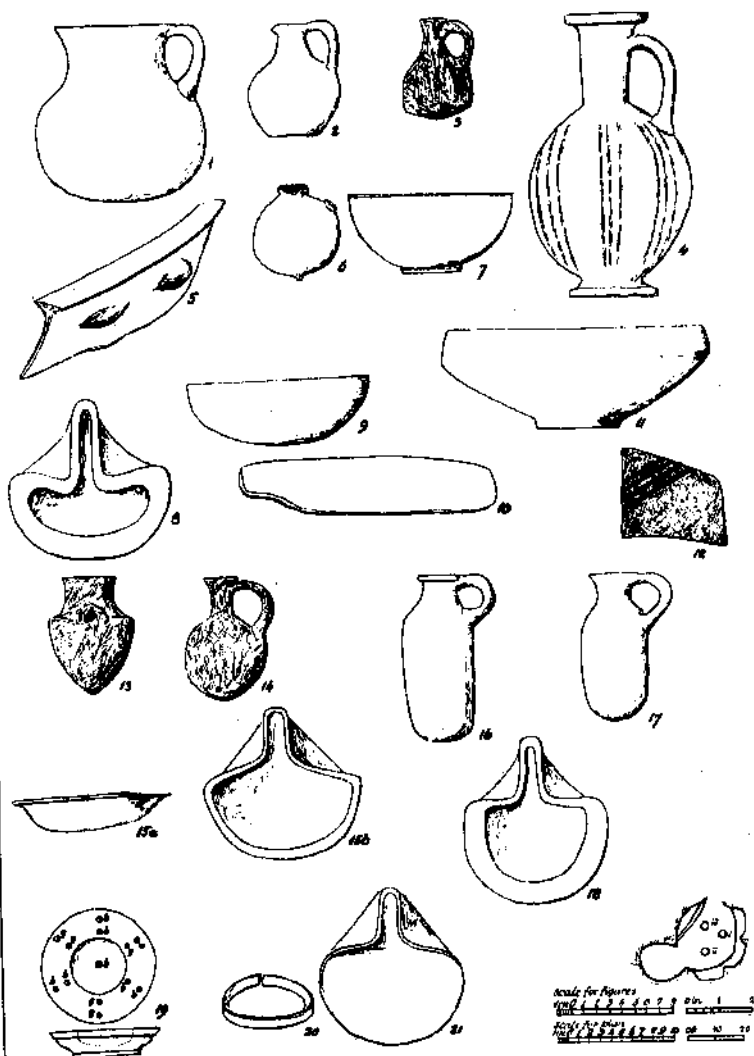





TOMB No. 36

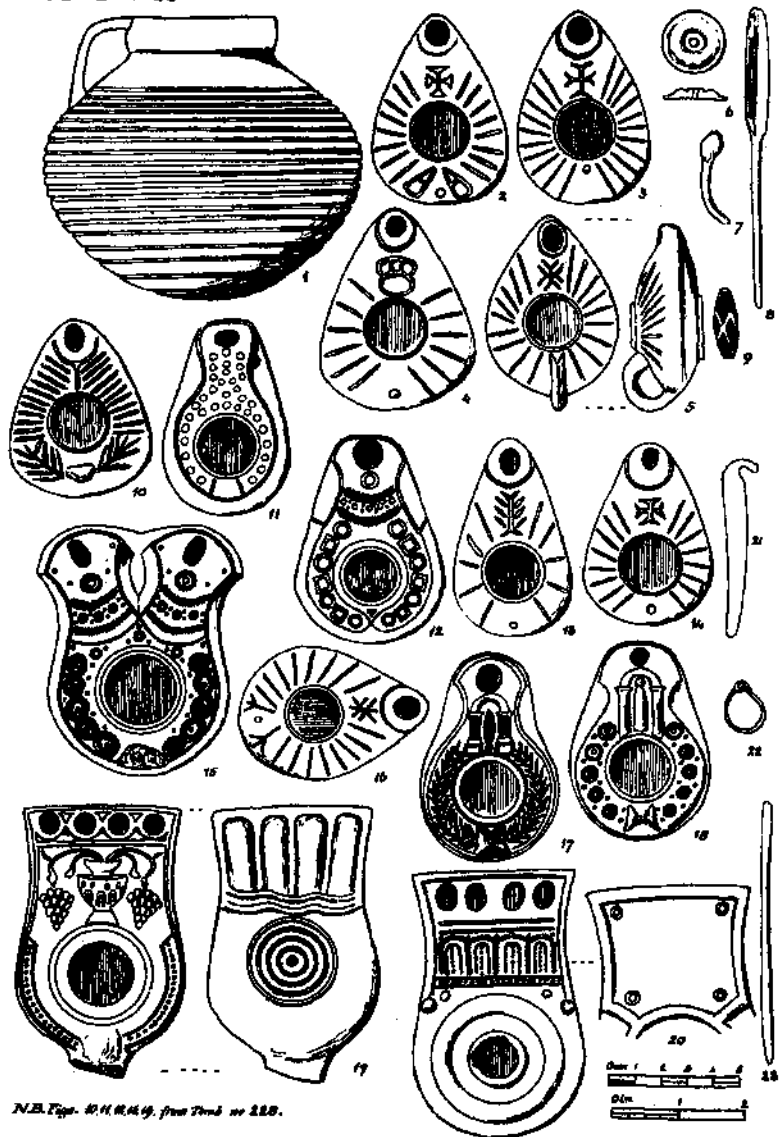

N.B. Type. 4011, 4012, 4013, from Tomb no. 228.







TOMB DEPOSITS

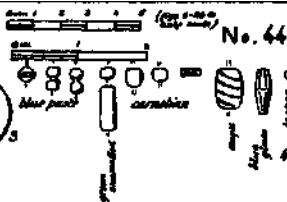

No. 42

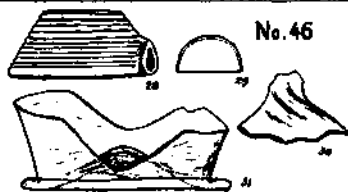
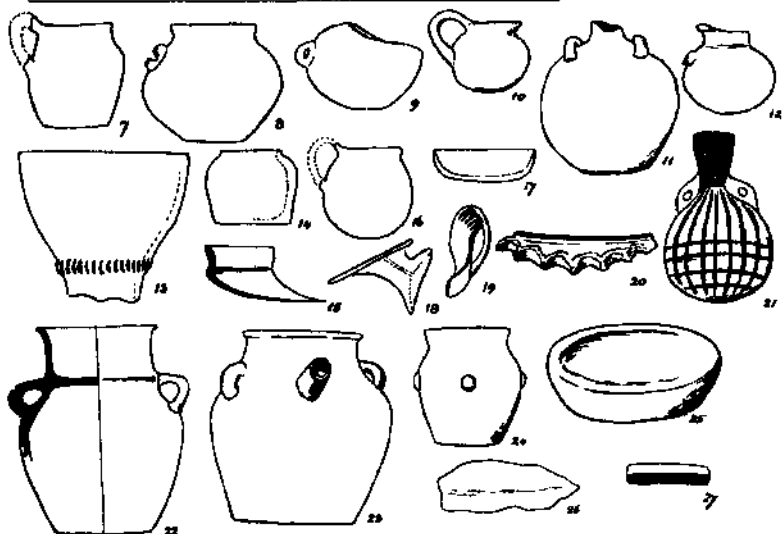

No. 46



No. 53

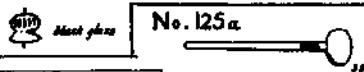

No. 125a



No. 56



No. 162



## TOMB No. 56

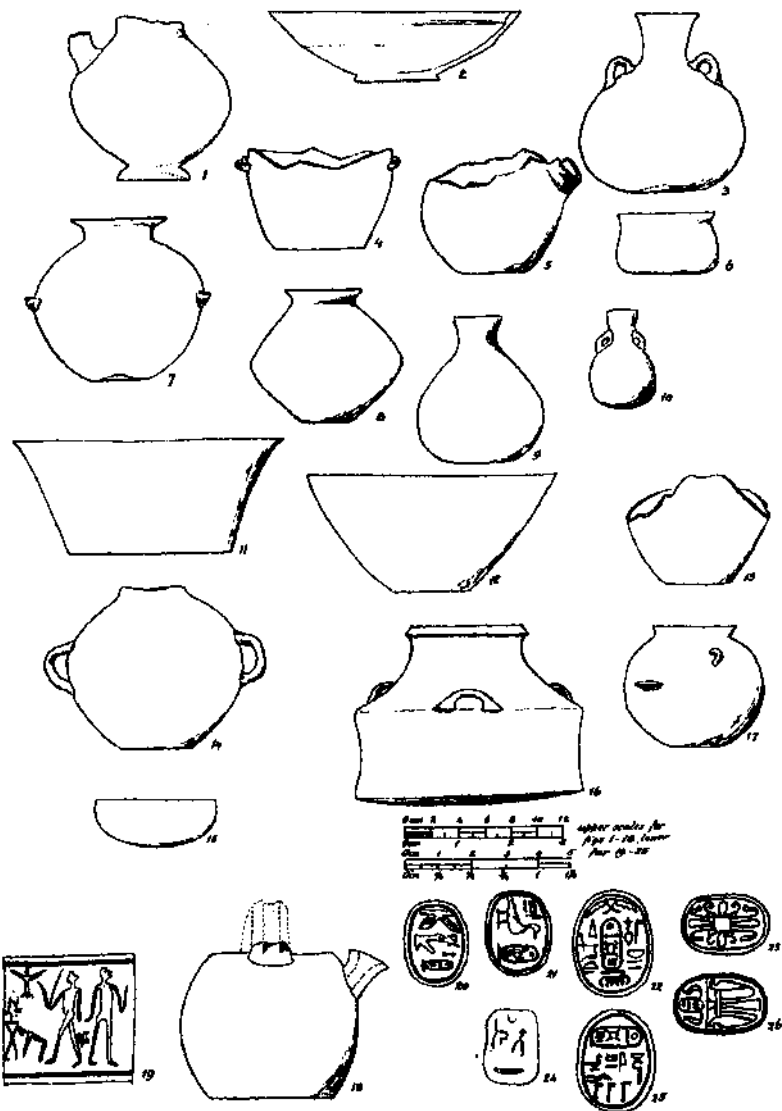





TOMB No. 56

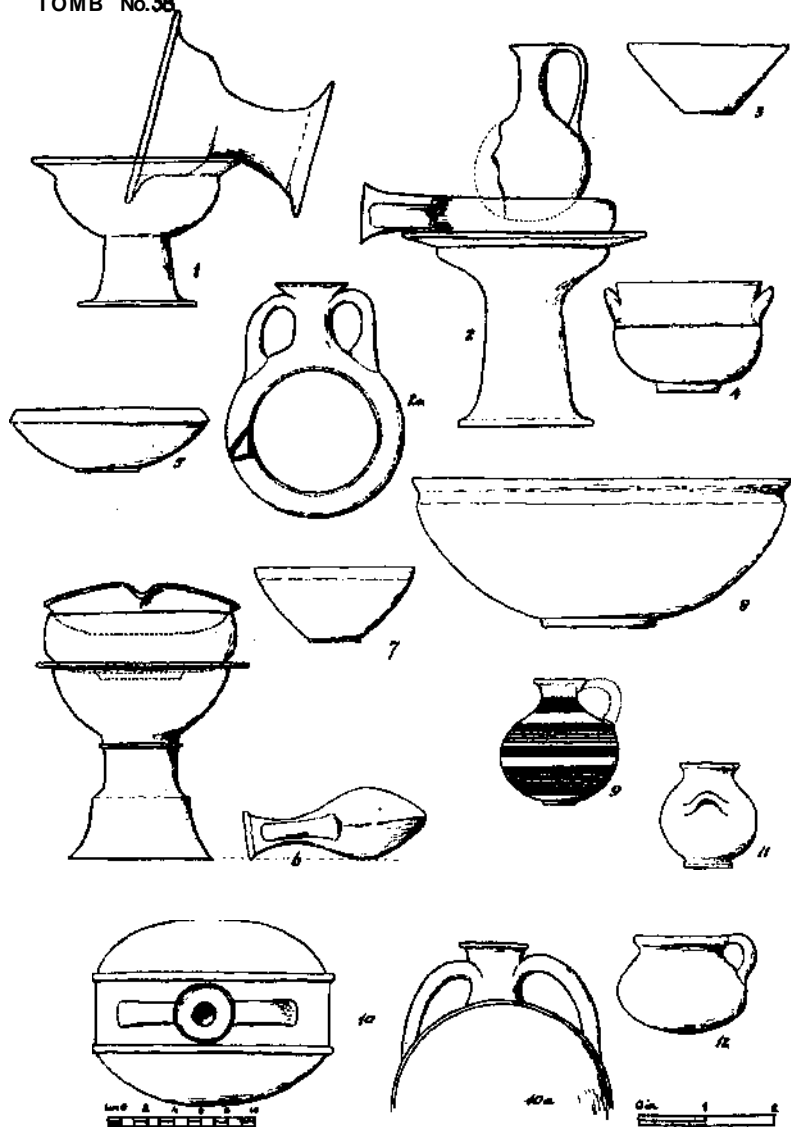







TOMB No. 58

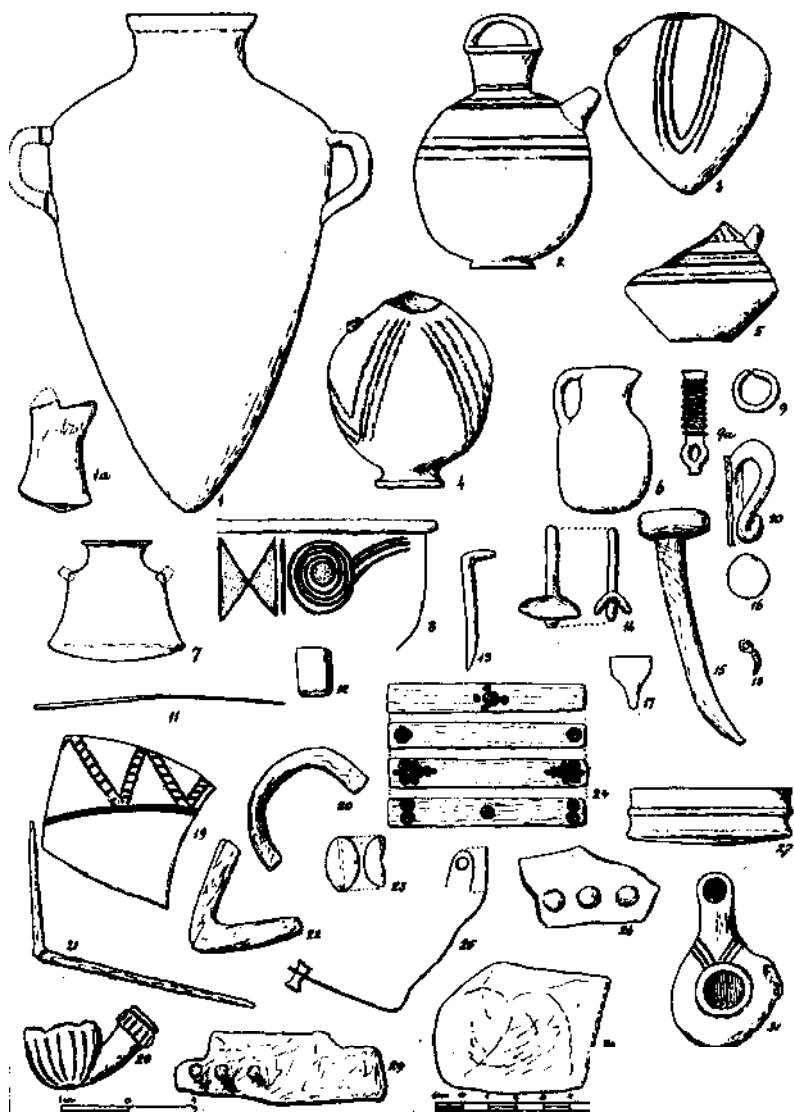

TOMB No 59

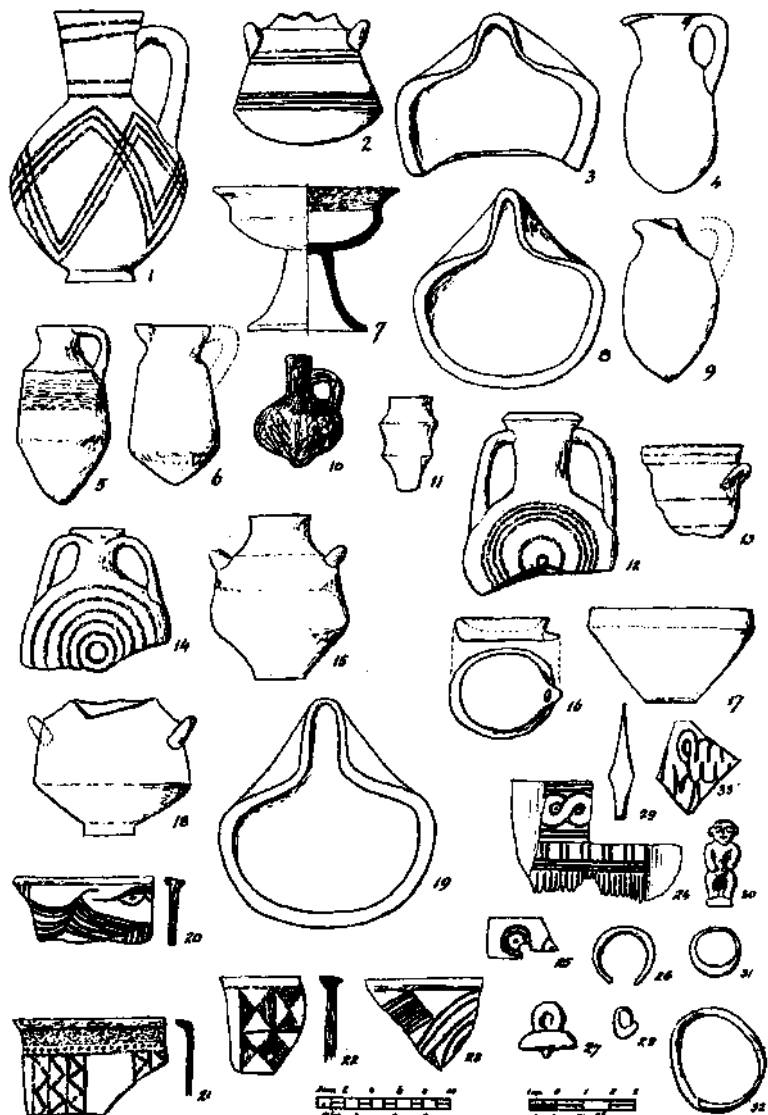





TOMB No 59



TOMBS No. 65-73

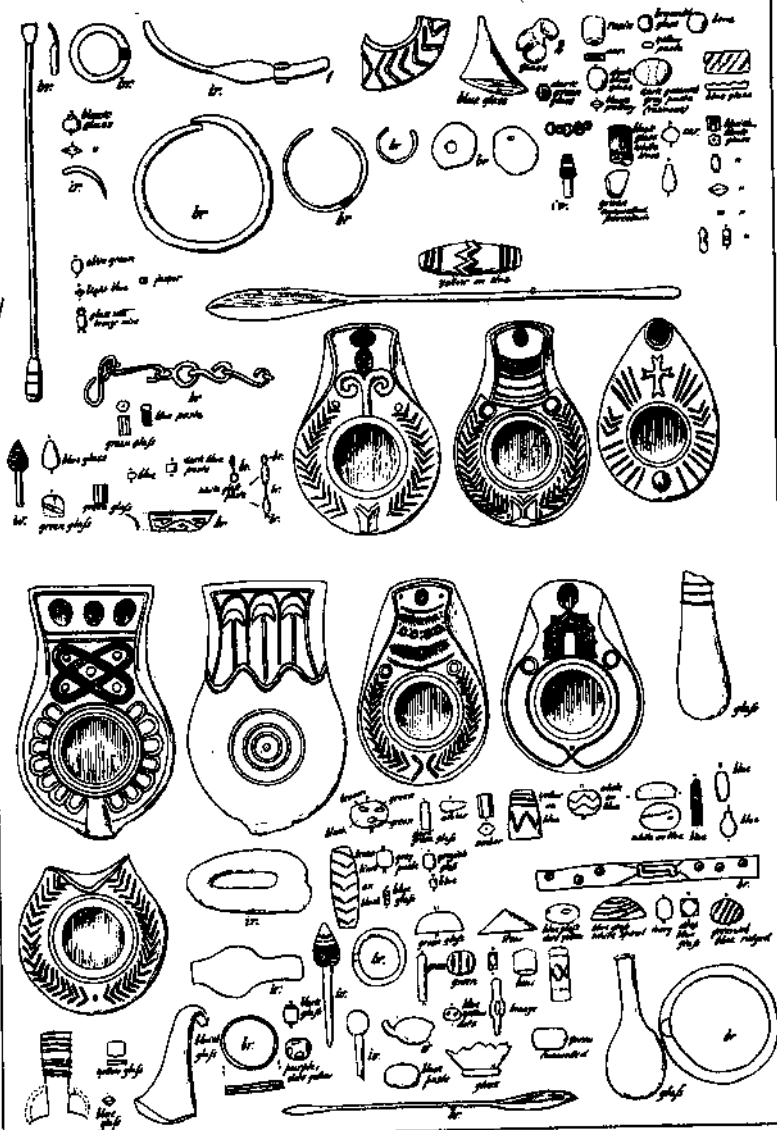





TOMBS No 84,85

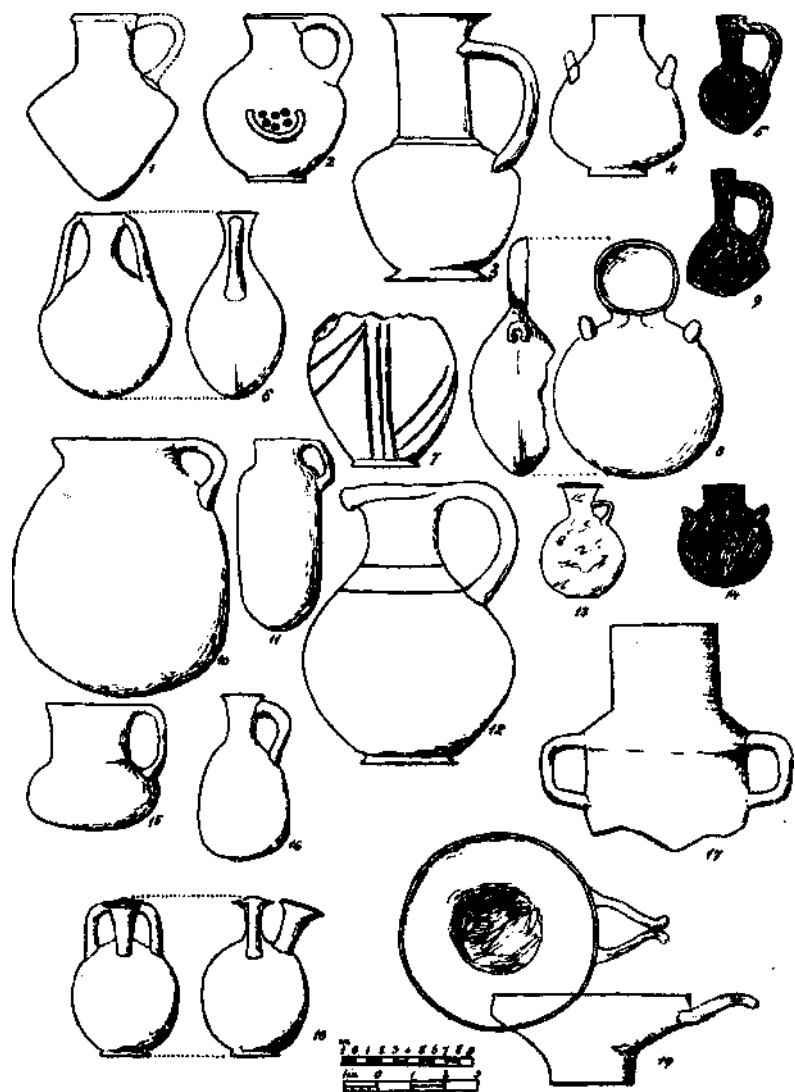

## TOMBS No. 84, 85

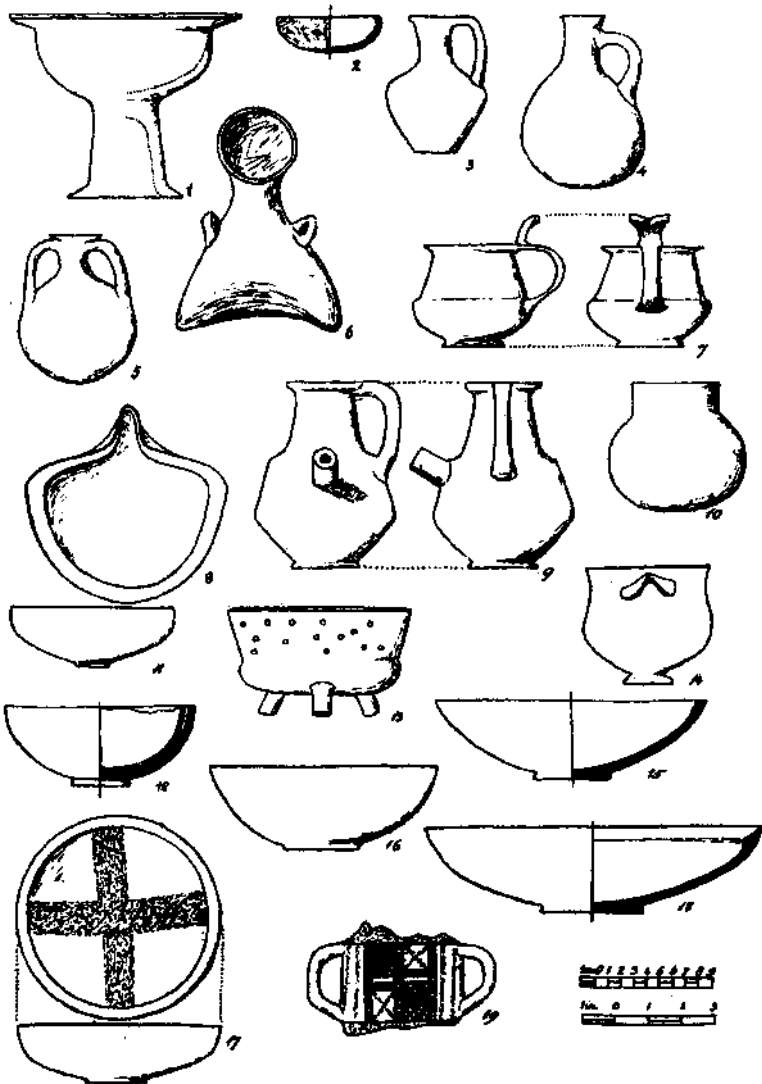





TOMBS No 84,85

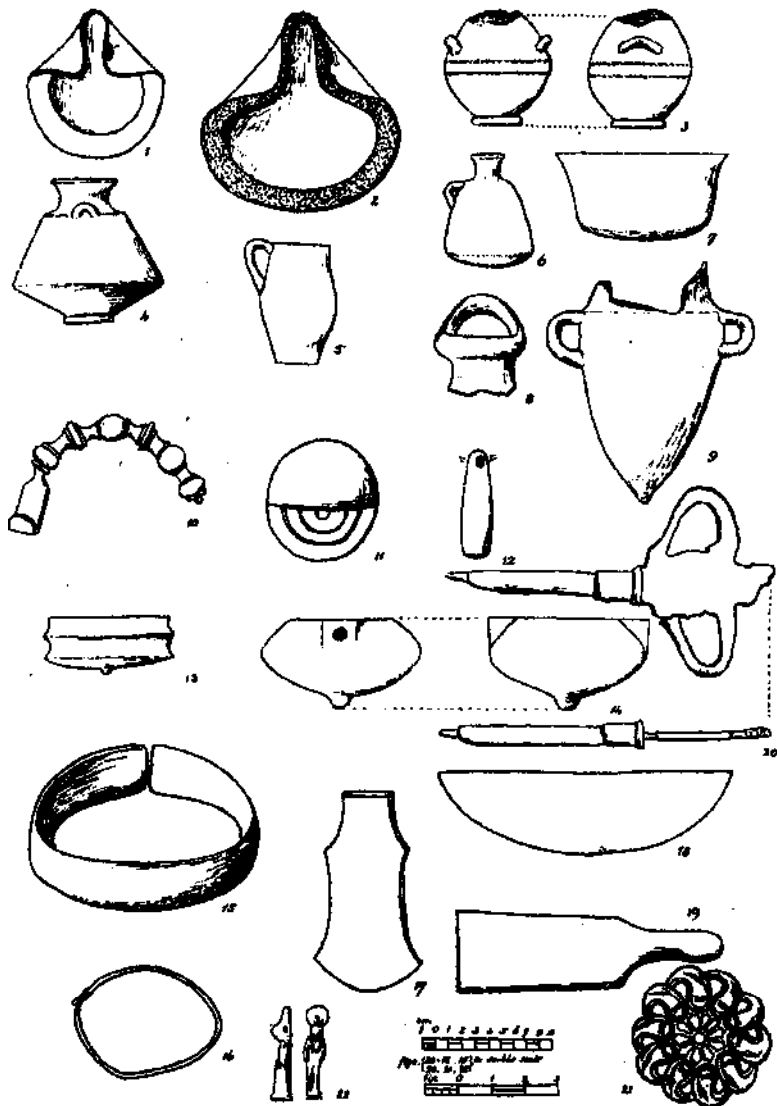

TOMB No. 96

Scale 1 2 3 4 5 6 7  
 pottery & bronze and  
 faience objects

0 1 2 3 4 5 6 7  
 cm

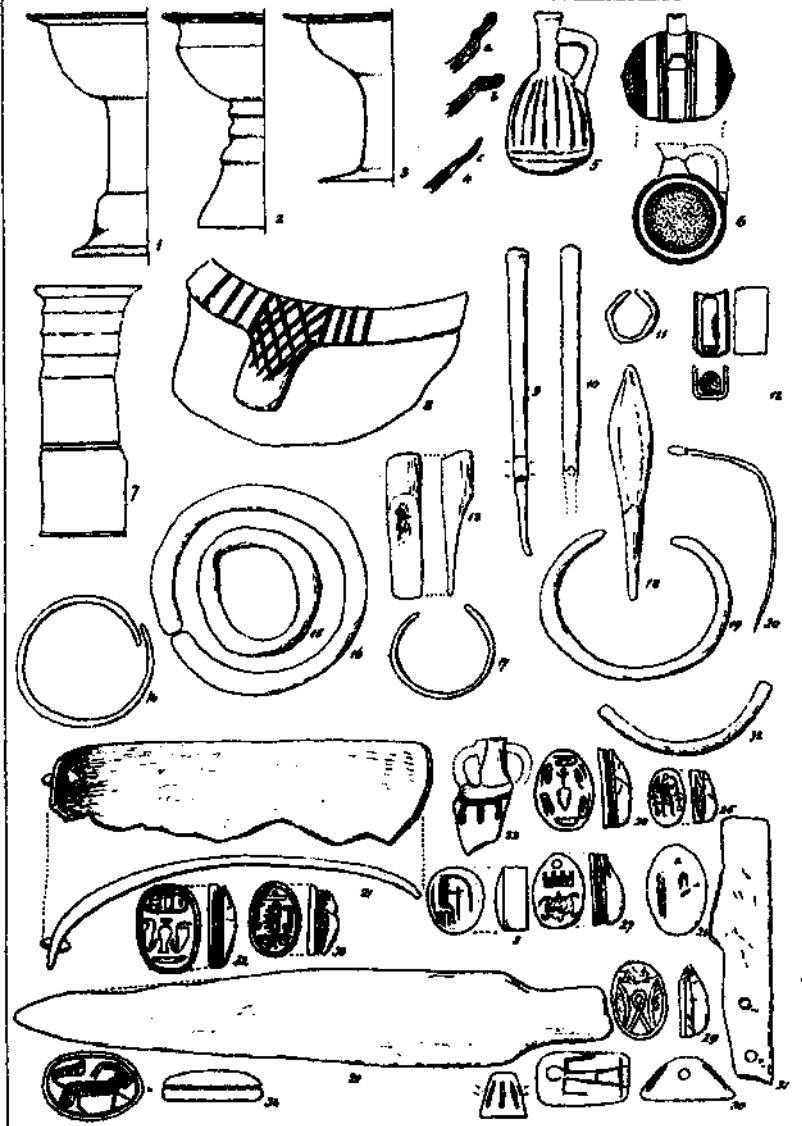





TOMB No. 99

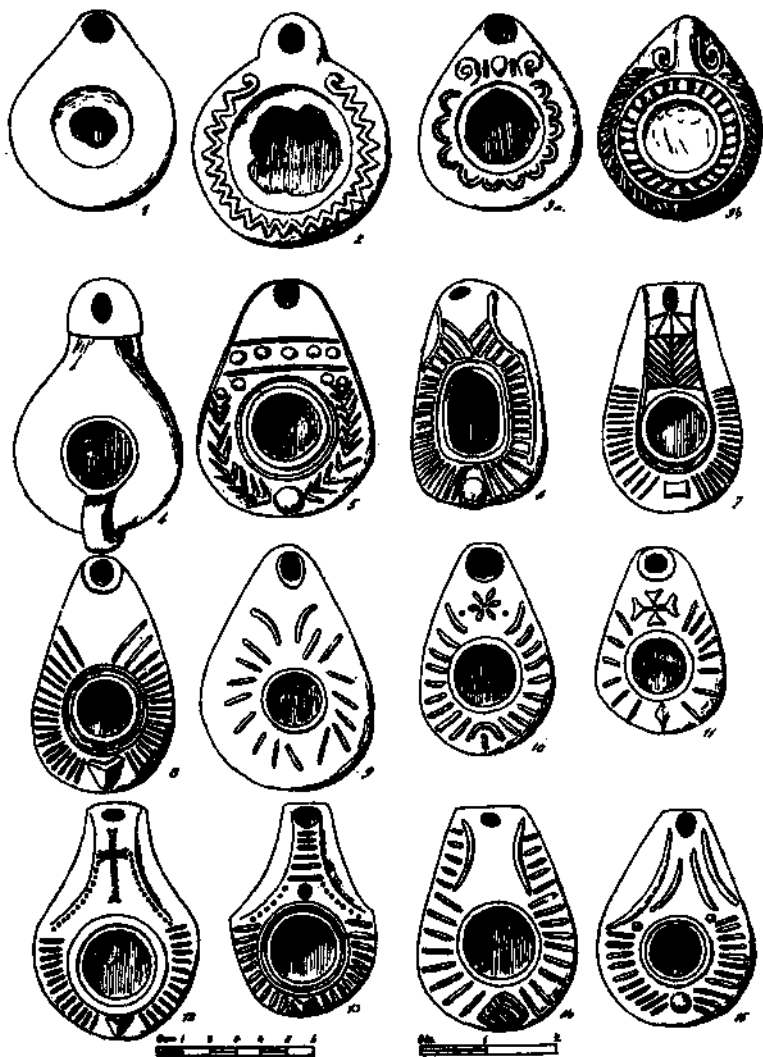

TOMB DEPOSITS

No. 99

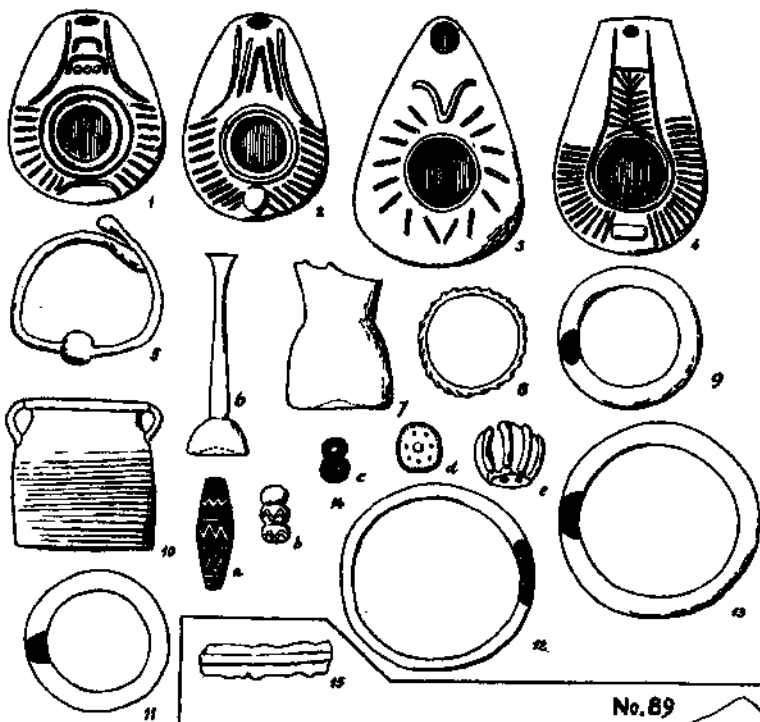

No. 89



Scale bars and a note: (Fig. 16-17 to half scale)



No. 82





TOMB No 103

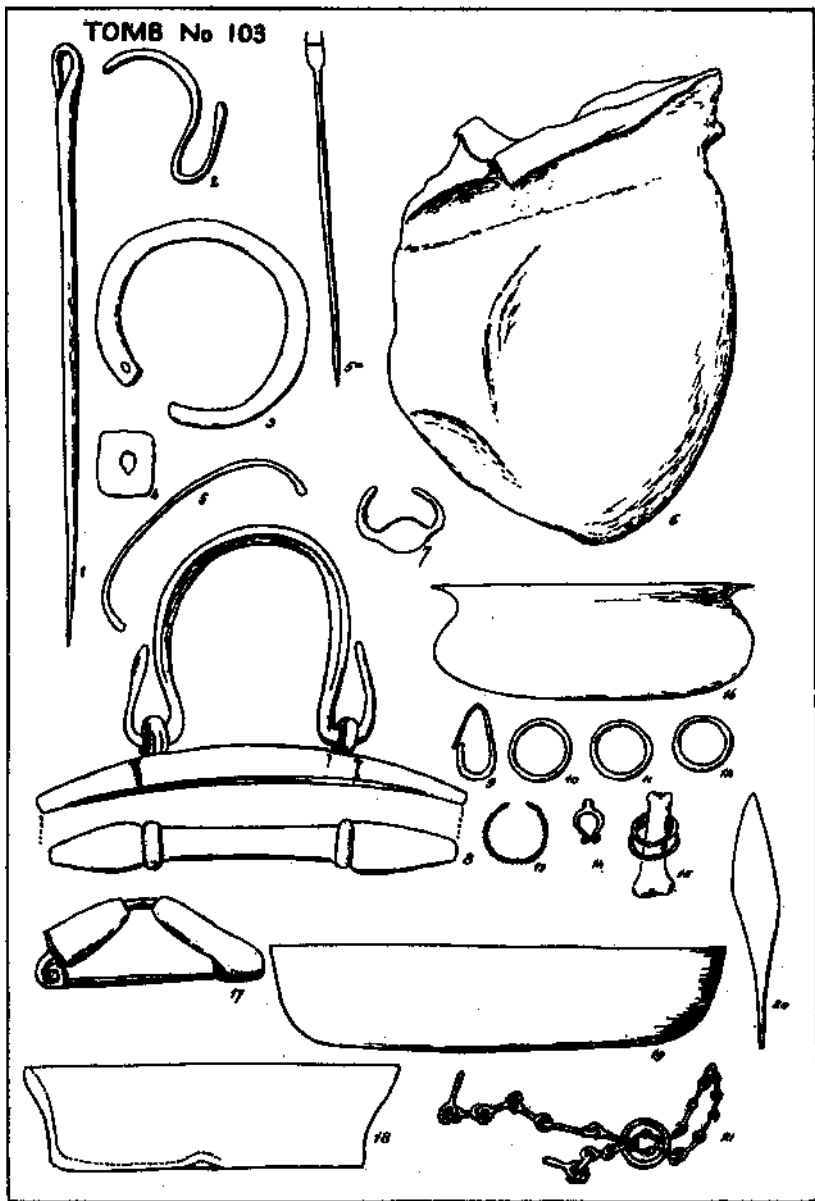

TOMB No. 103

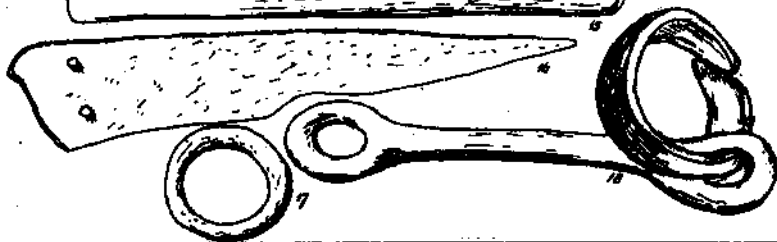
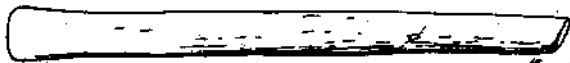
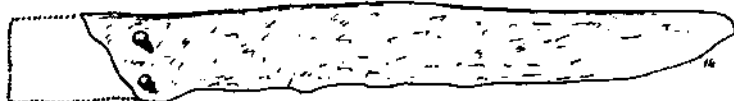
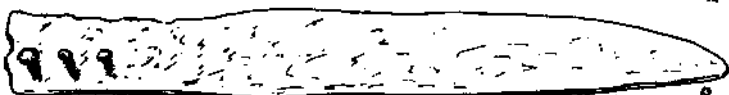
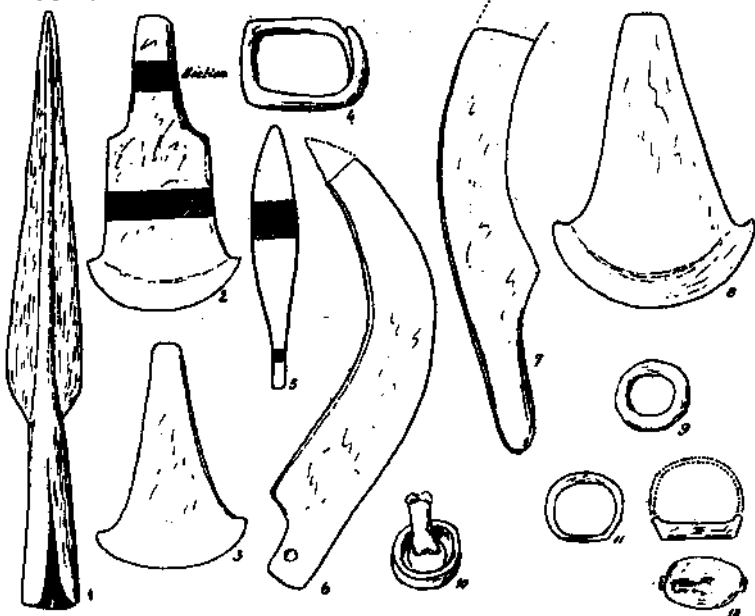





TOMB No. 103

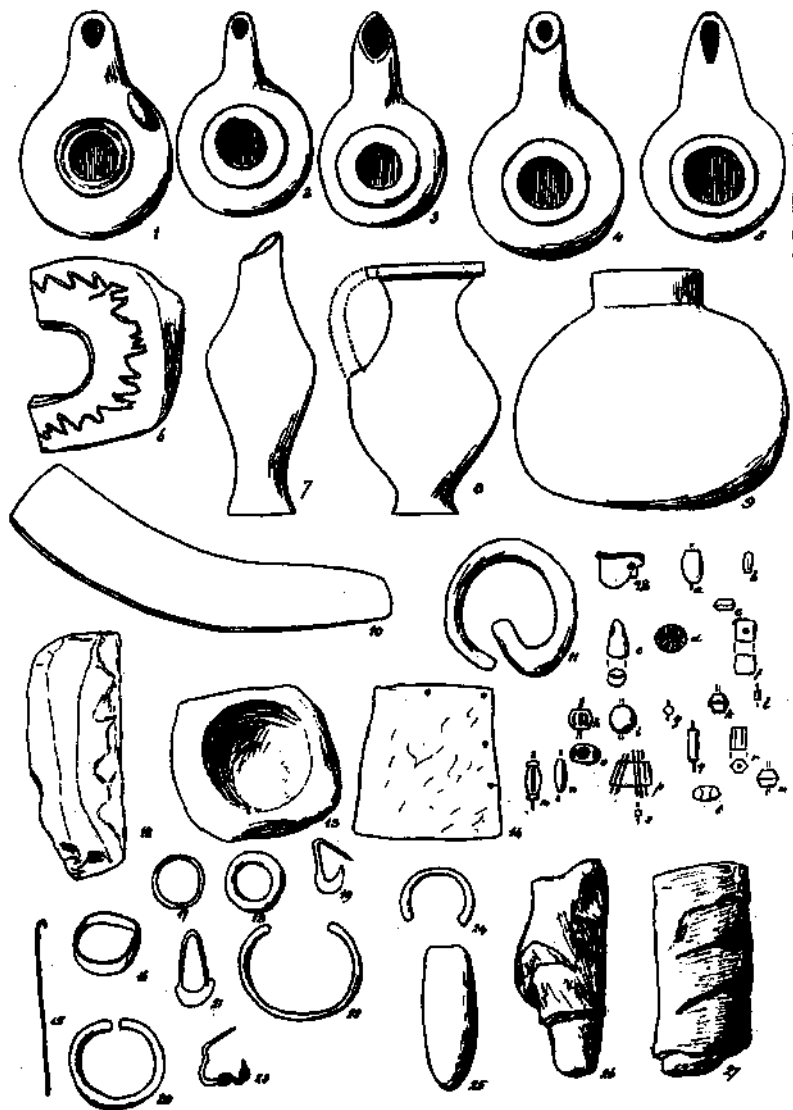

TOMB No 117

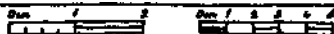
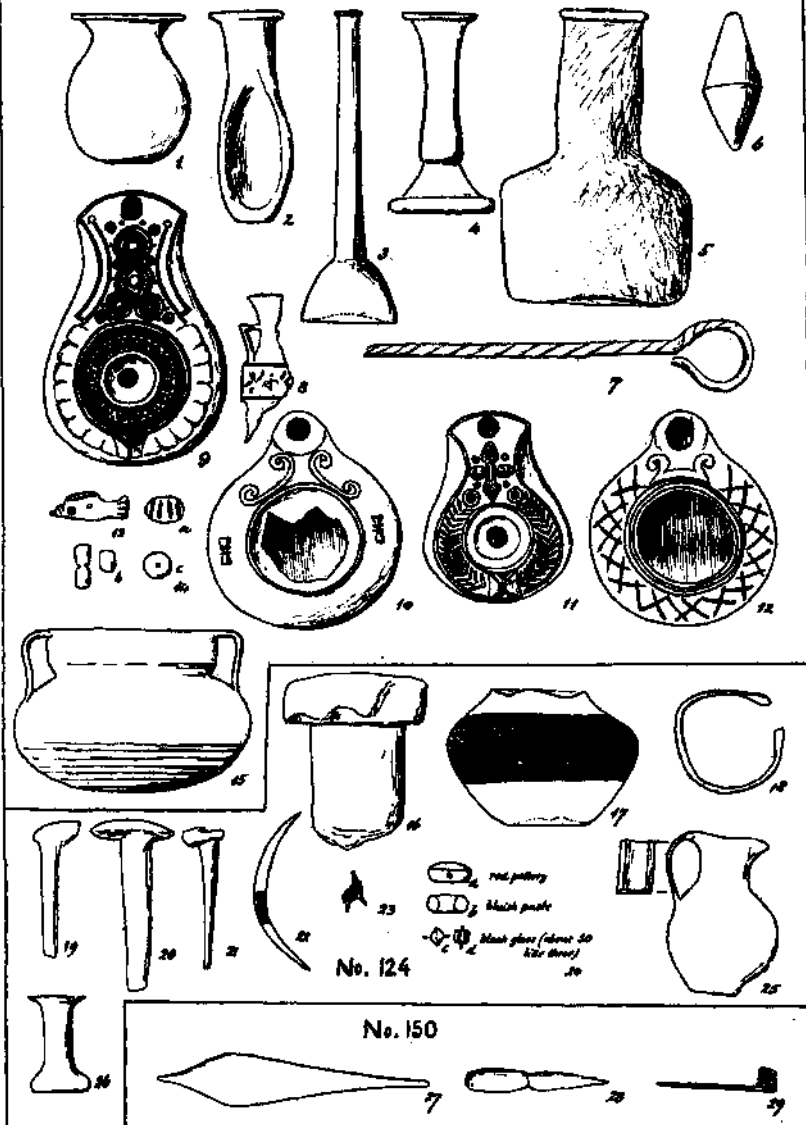

Fig. 17 & half scale



No. 124

No. 150





TOMB DEPOSITS



No. 118

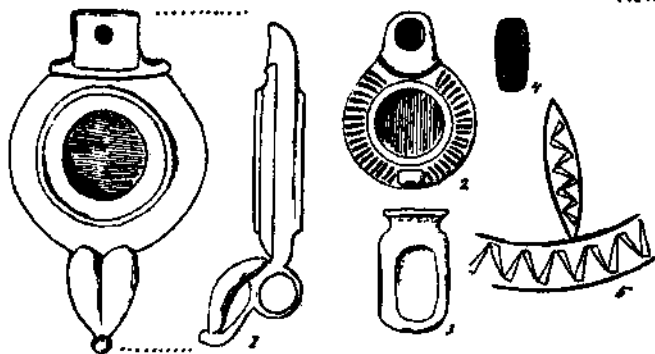

No. 128

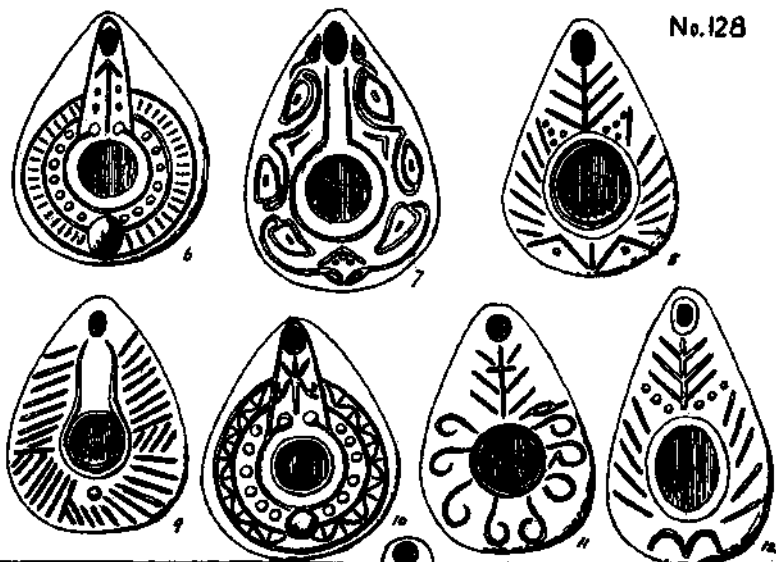

No 213



No. 158



No. 169



TOMB DEPOSITS

*Fig. 1-4, 17, 18, 20, 21, 22, 23-25, 27-31, 33, 34, 35, 36, 37-39, 41, 42, 43, 44, 45, 46, 47, 48, 49, 50, 51, 52, 53, 54, 55, 56, 57, 58, 59, 60, 61, 62, 63, 64, 65, 66, 67, 68, 69, 70, 71, 72, 73, 74, 75, 76, 77, 78, 79, 80, 81, 82, 83, 84, 85, 86, 87, 88, 89, 90, 91, 92, 93, 94, 95, 96, 97, 98, 99, 100, 101, 102, 103, 104, 105, 106, 107, 108, 109, 110, 111, 112, 113, 114, 115, 116, 117, 118, 119, 120, 121, 122, 123, 124, 125, 126, 127, 128, 129, 130, 131, 132, 133, 134, 135, 136, 137, 138, 139, 140, 141, 142, 143, 144, 145, 146, 147, 148, 149, 150, 151, 152, 153, 154, 155, 156, 157, 158, 159, 160, 161, 162, 163, 164, 165, 166, 167, 168, 169, 170, 171, 172, 173, 174, 175, 176, 177, 178, 179, 180, 181, 182, 183, 184, 185, 186, 187, 188, 189, 190, 191, 192, 193, 194, 195, 196, 197, 198, 199, 200, 201, 202, 203, 204, 205, 206, 207, 208, 209, 210, 211, 212, 213, 214, 215, 216, 217, 218, 219, 220, 221, 222, 223, 224, 225, 226, 227, 228, 229, 230, 231, 232, 233, 234, 235, 236, 237, 238, 239, 240, 241, 242, 243, 244, 245, 246, 247, 248, 249, 250, 251, 252, 253, 254, 255, 256, 257, 258, 259, 260, 261, 262, 263, 264, 265, 266, 267, 268, 269, 270, 271, 272, 273, 274, 275, 276, 277, 278, 279, 280, 281, 282, 283, 284, 285, 286, 287, 288, 289, 290, 291, 292, 293, 294, 295, 296, 297, 298, 299, 300, 301, 302, 303, 304, 305, 306, 307, 308, 309, 310, 311, 312, 313, 314, 315, 316, 317, 318, 319, 320, 321, 322, 323, 324, 325, 326, 327, 328, 329, 330, 331, 332, 333, 334, 335, 336, 337, 338, 339, 340, 341, 342, 343, 344, 345, 346, 347, 348, 349, 350, 351, 352, 353, 354, 355, 356, 357, 358, 359, 360, 361, 362, 363, 364, 365, 366, 367, 368, 369, 370, 371, 372, 373, 374, 375, 376, 377, 378, 379, 380, 381, 382, 383, 384, 385, 386, 387, 388, 389, 390, 391, 392, 393, 394, 395, 396, 397, 398, 399, 400, 401, 402, 403, 404, 405, 406, 407, 408, 409, 410, 411, 412, 413, 414, 415, 416, 417, 418, 419, 420, 421, 422, 423, 424, 425, 426, 427, 428, 429, 430, 431, 432, 433, 434, 435, 436, 437, 438, 439, 440, 441, 442, 443, 444, 445, 446, 447, 448, 449, 450, 451, 452, 453, 454, 455, 456, 457, 458, 459, 460, 461, 462, 463, 464, 465, 466, 467, 468, 469, 470, 471, 472, 473, 474, 475, 476, 477, 478, 479, 480, 481, 482, 483, 484, 485, 486, 487, 488, 489, 490, 491, 492, 493, 494, 495, 496, 497, 498, 499, 500, 501, 502, 503, 504, 505, 506, 507, 508, 509, 510, 511, 512, 513, 514, 515, 516, 517, 518, 519, 520, 521, 522, 523, 524, 525, 526, 527, 528, 529, 530, 531, 532, 533, 534, 535, 536, 537, 538, 539, 540, 541, 542, 543, 544, 545, 546, 547, 548, 549, 550, 551, 552, 553, 554, 555, 556, 557, 558, 559, 560, 561, 562, 563, 564, 565, 566, 567, 568, 569, 570, 571, 572, 573, 574, 575, 576, 577, 578, 579, 580, 581, 582, 583, 584, 585, 586, 587, 588, 589, 590, 591, 592, 593, 594, 595, 596, 597, 598, 599, 600, 601, 602, 603, 604, 605, 606, 607, 608, 609, 610, 611, 612, 613, 614, 615, 616, 617, 618, 619, 620, 621, 622, 623, 624, 625, 626, 627, 628, 629, 630, 631, 632, 633, 634, 635, 636, 637, 638, 639, 640, 641, 642, 643, 644, 645, 646, 647, 648, 649, 650, 651, 652, 653, 654, 655, 656, 657, 658, 659, 660, 661, 662, 663, 664, 665, 666, 667, 668, 669, 670, 671, 672, 673, 674, 675, 676, 677, 678, 679, 680, 681, 682, 683, 684, 685, 686, 687, 688, 689, 690, 691, 692, 693, 694, 695, 696, 697, 698, 699, 700, 701, 702, 703, 704, 705, 706, 707, 708, 709, 710, 711, 712, 713, 714, 715, 716, 717, 718, 719, 720, 721, 722, 723, 724, 725, 726, 727, 728, 729, 730, 731, 732, 733, 734, 735, 736, 737, 738, 739, 740, 741, 742, 743, 744, 745, 746, 747, 748, 749, 750, 751, 752, 753, 754, 755, 756, 757, 758, 759, 760, 761, 762, 763, 764, 765, 766, 767, 768, 769, 770, 771, 772, 773, 774, 775, 776, 777, 778, 779, 780, 781, 782, 783, 784, 785, 786, 787, 788, 789, 790, 791, 792, 793, 794, 795, 796, 797, 798, 799, 800, 801, 802, 803, 804, 805, 806, 807, 808, 809, 810, 811, 812, 813, 814, 815, 816, 817, 818, 819, 820, 821, 822, 823, 824, 825, 826, 827, 828, 829, 830, 831, 832, 833, 834, 835, 836, 837, 838, 839, 840, 841, 842, 843, 844, 845, 846, 847, 848, 849, 850, 851, 852, 853, 854, 855, 856, 857, 858, 859, 860, 861, 862, 863, 864, 865, 866, 867, 868, 869, 870, 871, 872, 873, 874, 875, 876, 877, 878, 879, 880, 881, 882, 883, 884, 885, 886, 887, 888, 889, 890, 891, 892, 893, 894, 895, 896, 897, 898, 899, 900, 901, 902, 903, 904, 905, 906, 907, 908, 909, 910, 911, 912, 913, 914, 915, 916, 917, 918, 919, 920, 921, 922, 923, 924, 925, 926, 927, 928, 929, 930, 931, 932, 933, 934, 935, 936, 937, 938, 939, 940, 941, 942, 943, 944, 945, 946, 947, 948, 949, 950, 951, 952, 953, 954, 955, 956, 957, 958, 959, 960, 961, 962, 963, 964, 965, 966, 967, 968, 969, 970, 971, 972, 973, 974, 975, 976, 977, 978, 979, 980, 981, 982, 983, 984, 985, 986, 987, 988, 989, 990, 991, 992, 993, 994, 995, 996, 997, 998, 999, 1000*

No. 131



No. 123

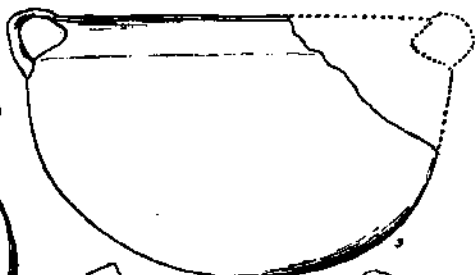

No. 64

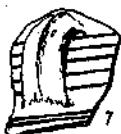

No. 56

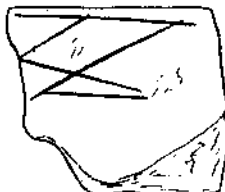
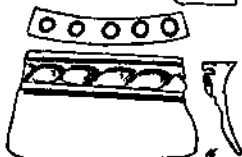

No. 80





TOMB N. 124

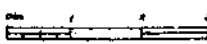
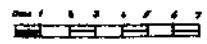

for dimensions of figs. 17, 18, see description.

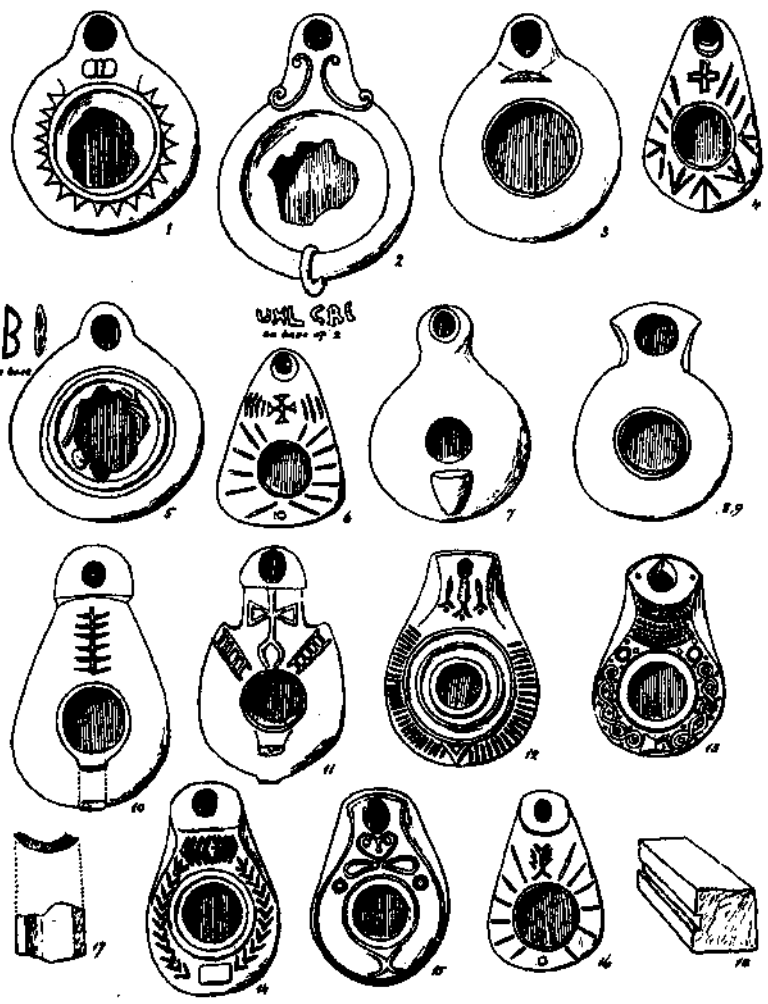

B  
on base

WHL GRI  
on base of 2

TOMB DEPOSITS

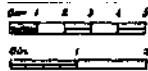

No. 194

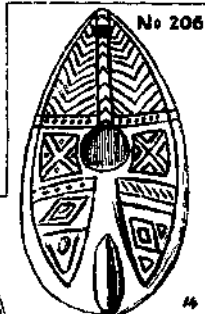
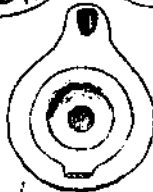
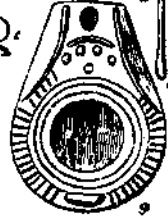
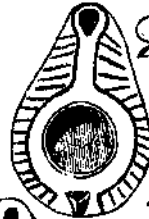
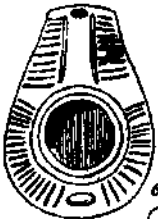
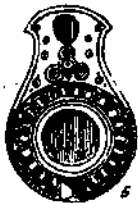
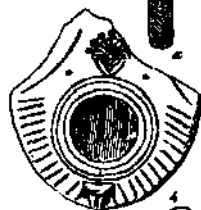
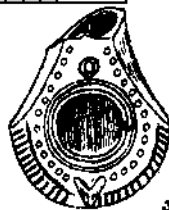
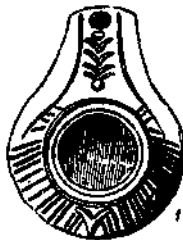

No 206

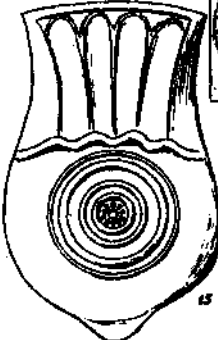
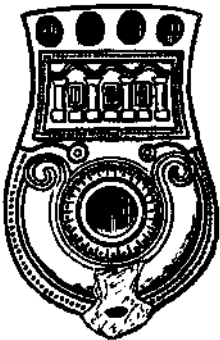
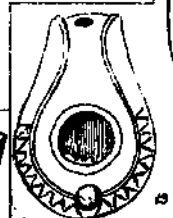

No. 36 (see also plate 100)

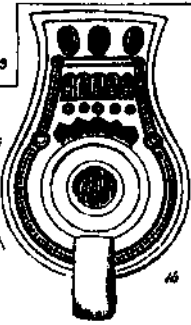





TOMB DEPOSITS

No. 138

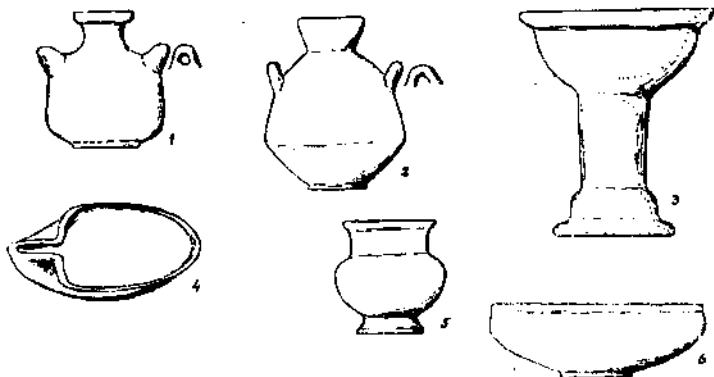

No. 139

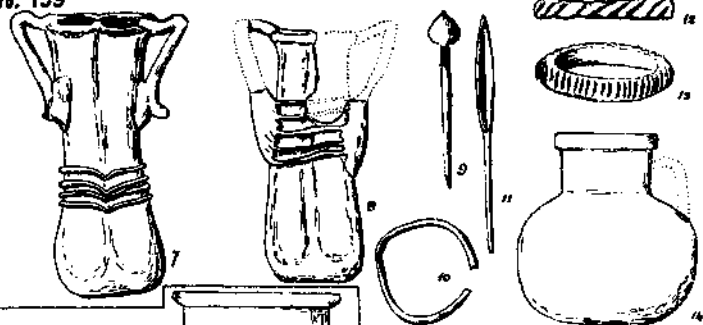

No. 7

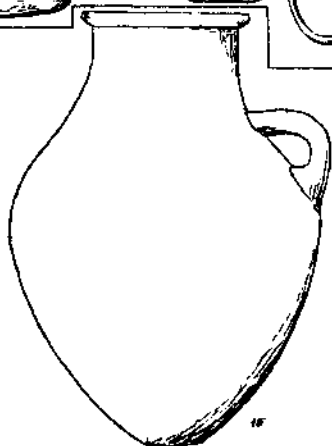

No. 144

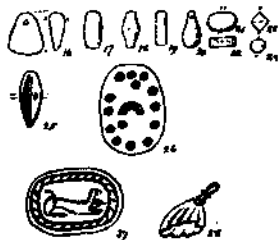
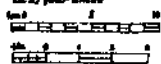
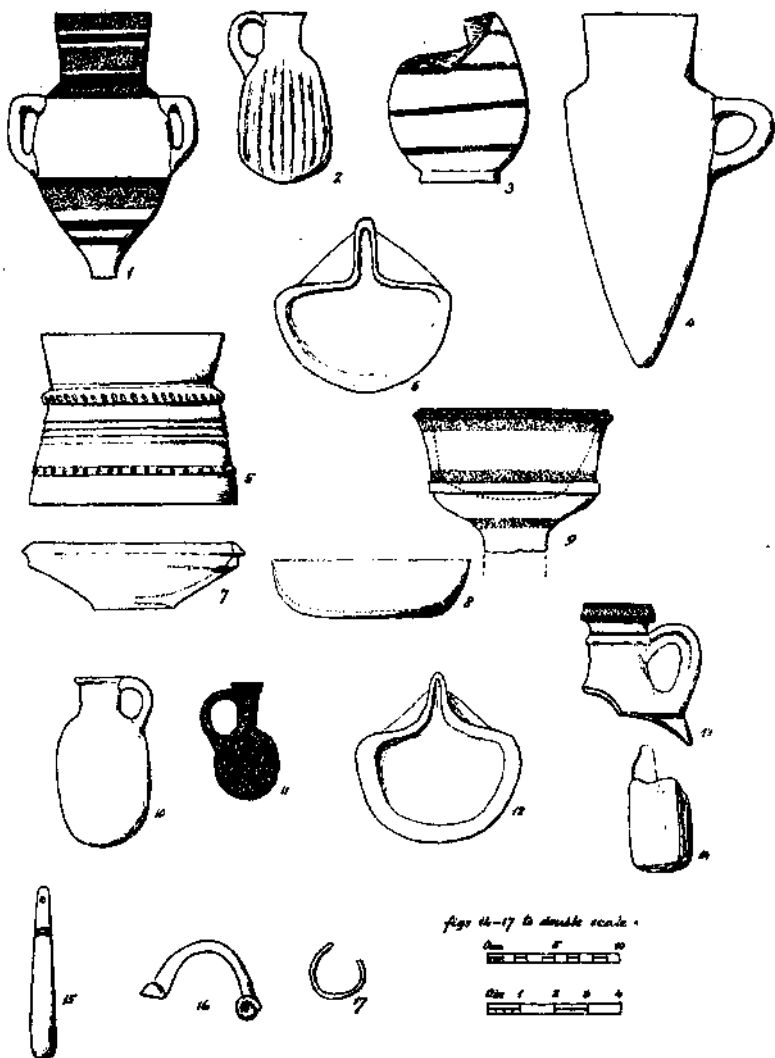

Fig. 16 de half ounce, figs 7-13, 16-21, 23 double, 22, 24 four times



TOMB No. 142







TOMB No. 147

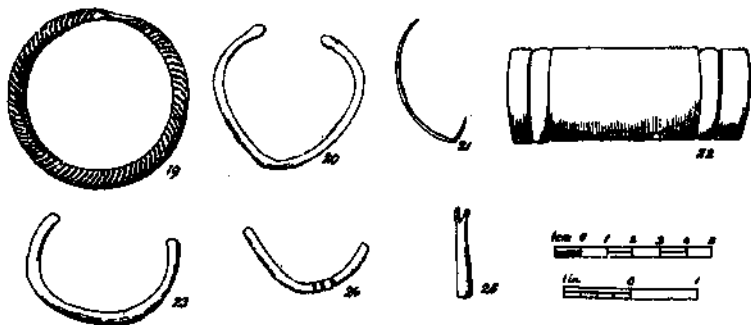
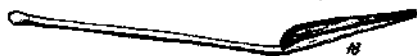
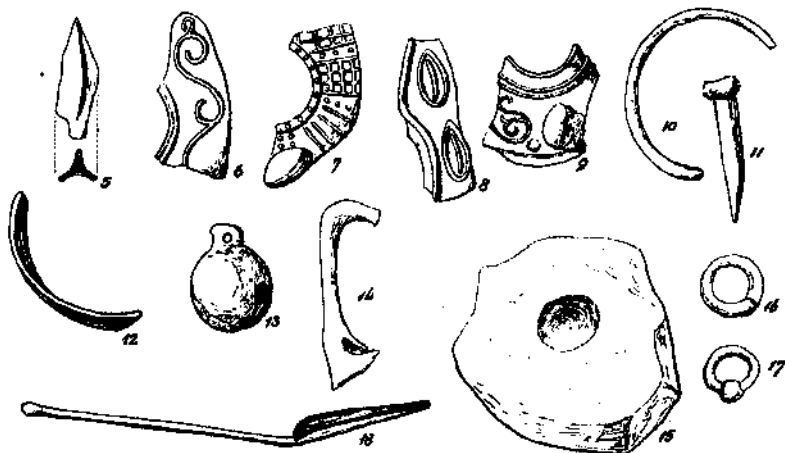
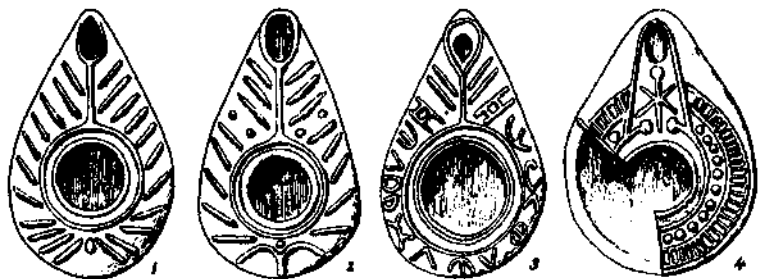

TOMB No 147



26



27



28

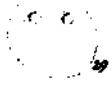

29



30



34



35



37



39



31



38

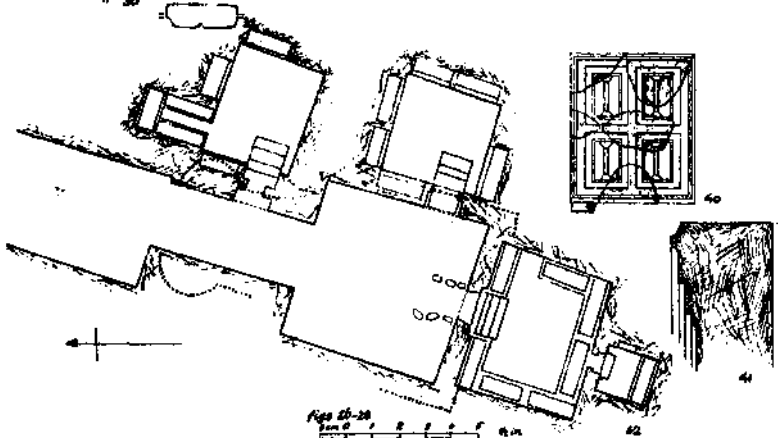

Figs 40-42

Figs 43-45

Figs 46-48

Figs 49-51

Figs 52-54

Fig 41

Figs 29-32

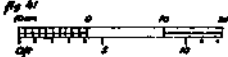
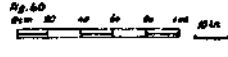





TOMB DEPOSITS

No. 152

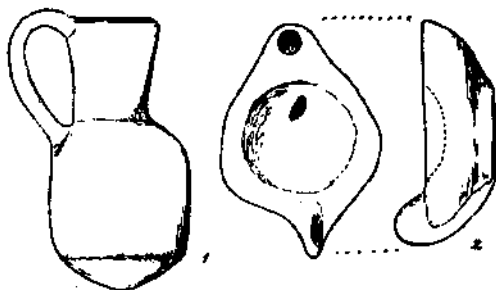

No. 143

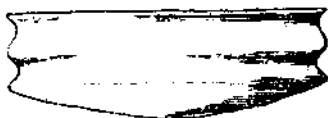
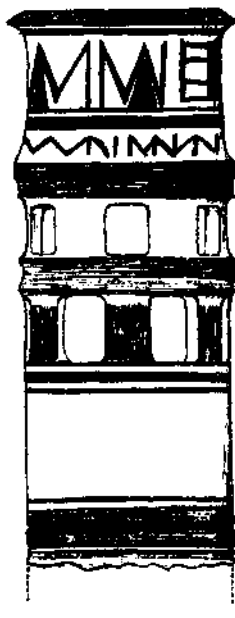
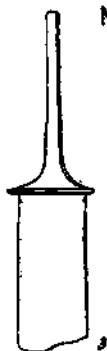

No. 66



No. 194

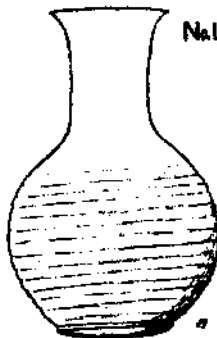

*this object from tomb 142*

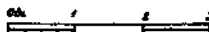
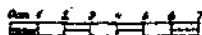

TOMB DEPOSITS

Fig. 1-5, 20, to half scale; 6-19 double scale.

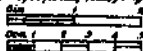

No. 153

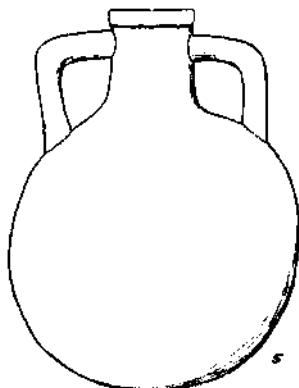
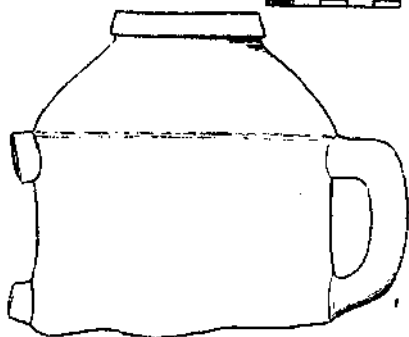

No. 242



No. 227

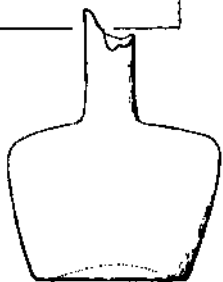
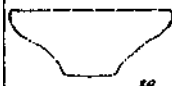

23

24





TOMB No. 156

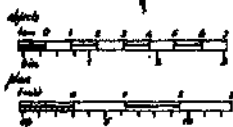
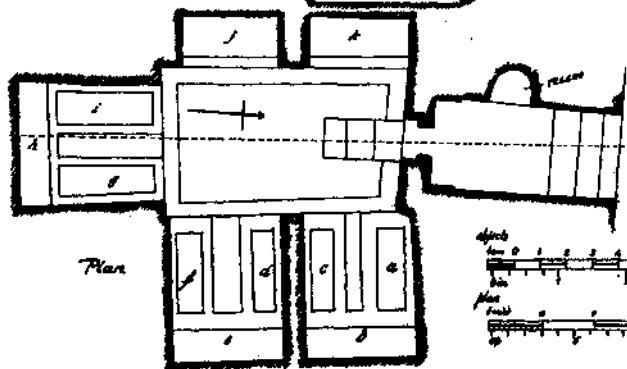
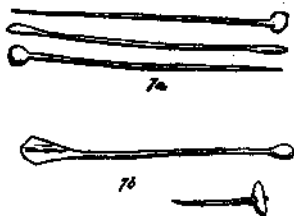
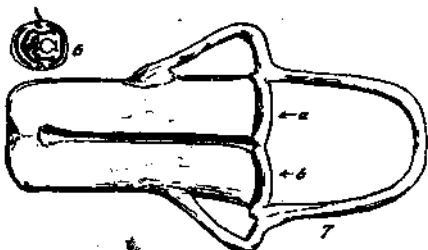
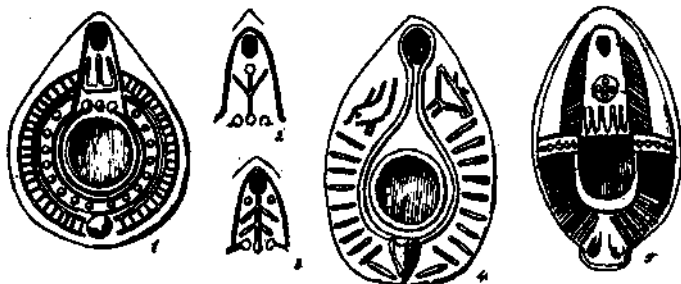

TOMB DEPOSITS

No. 157

No. 218

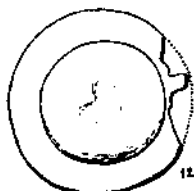
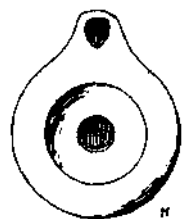
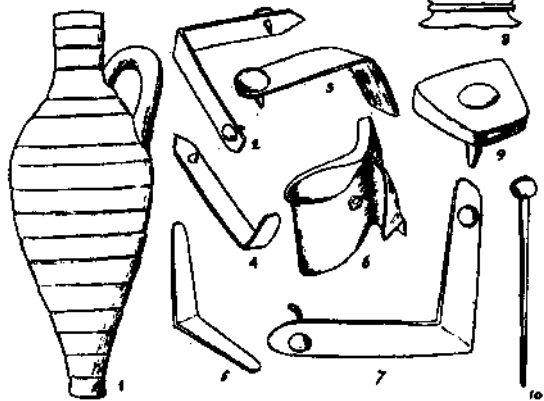

No. 78

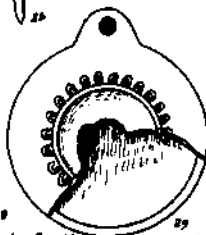
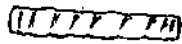
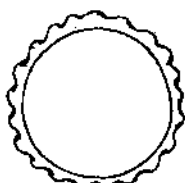
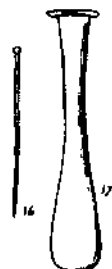
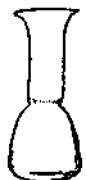

No. 148



No. 145



No. 201







TOMB No. 160

(TOMB OF STEPHANOS PHILOCHRISTOS)

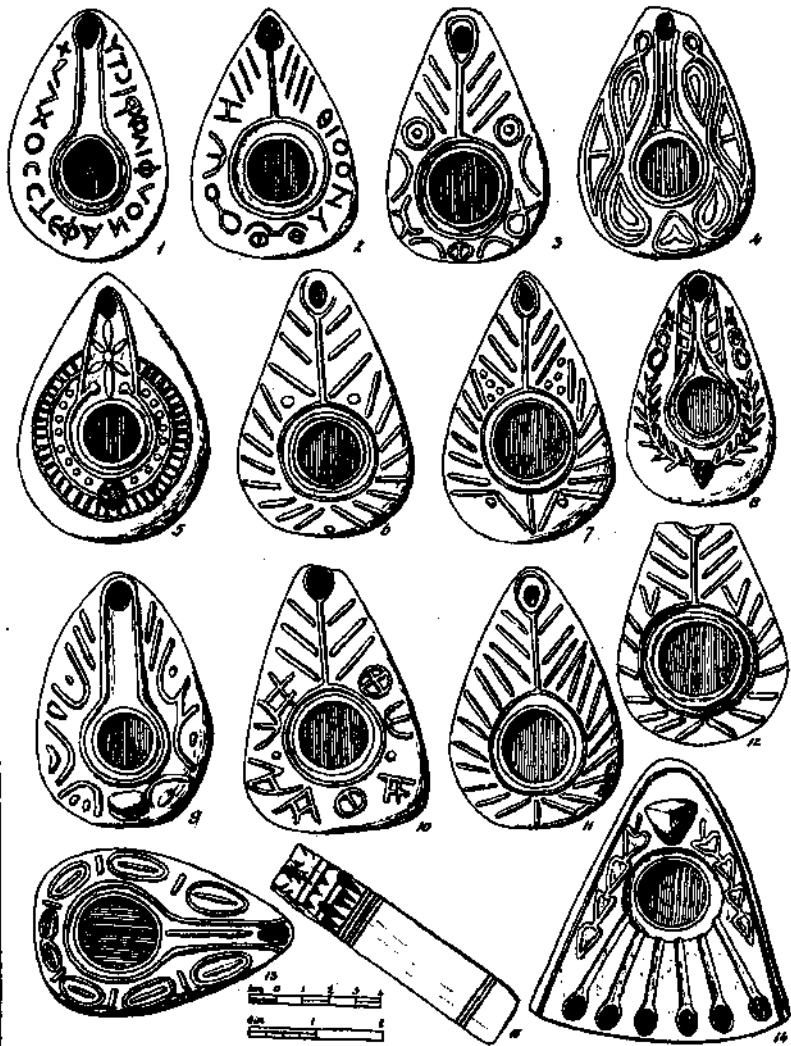

TOMB No. 160

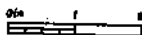
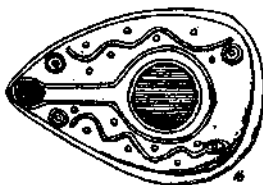
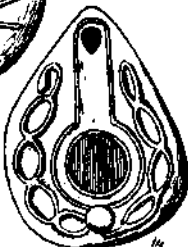
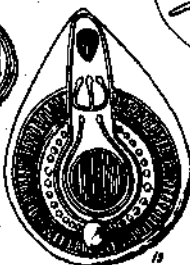
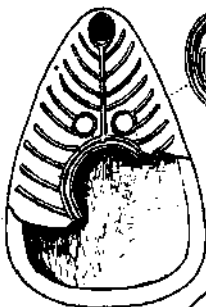
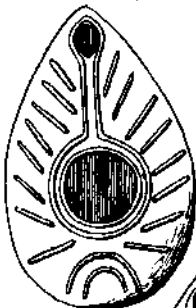
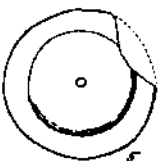
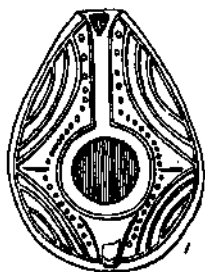





TOMB No. 160

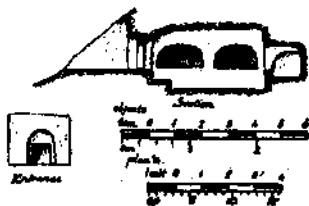
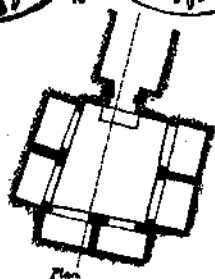
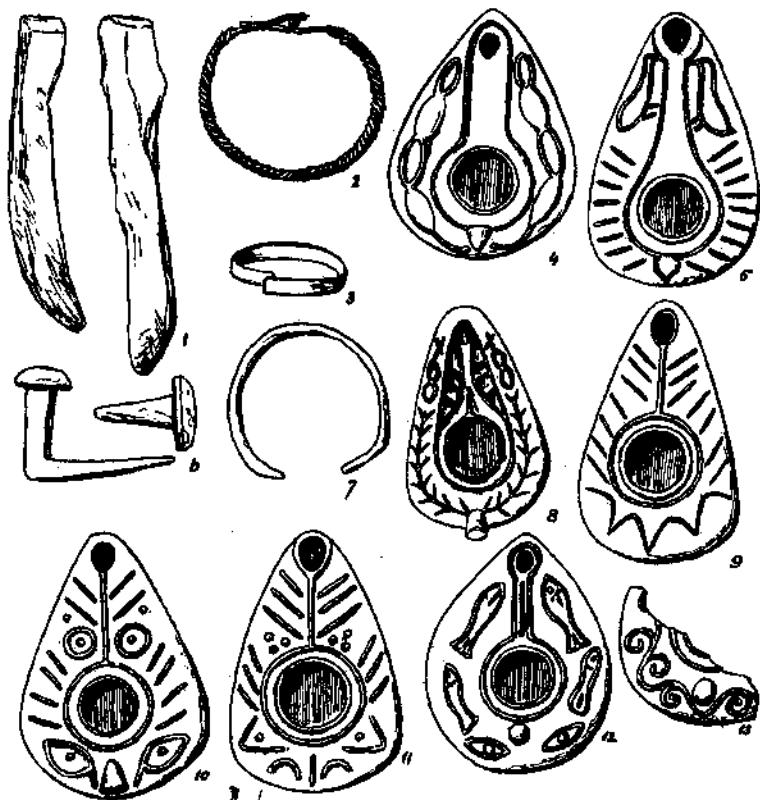

TOMB DEPOSITS

No. 167

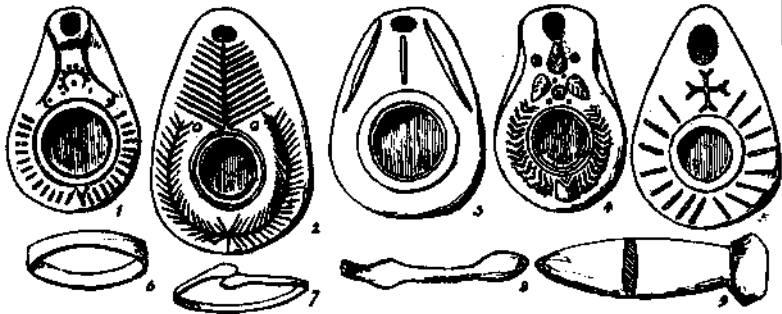

No. 155

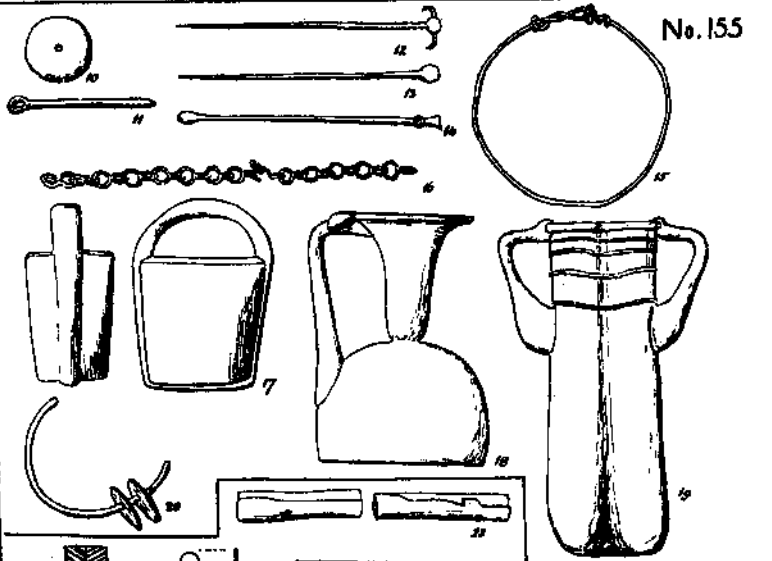

No. 158



No. 128

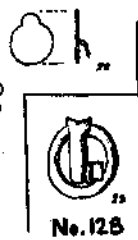

No. 129

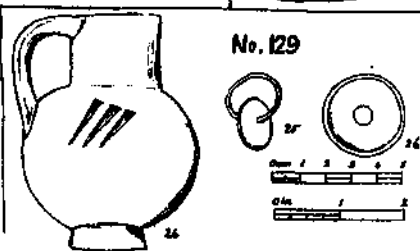









TOMB No. 176

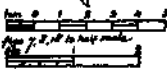
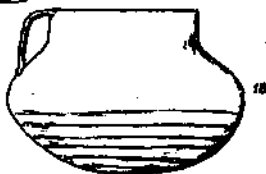
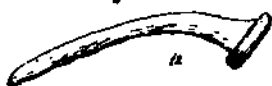
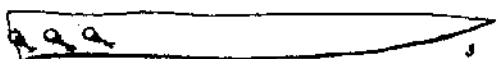

## TOMB No. 185

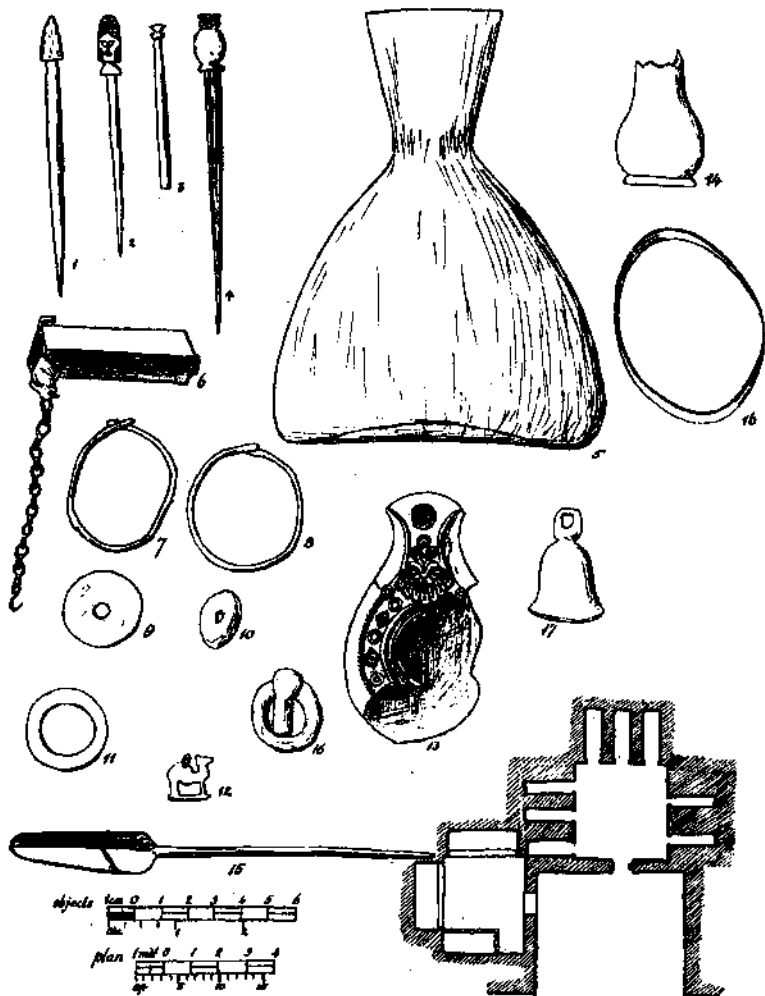

TOMB DEPOSITS

Fig. 4 is half scale

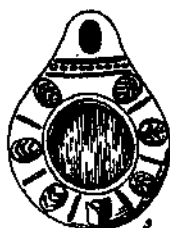
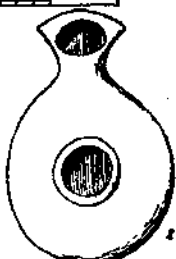
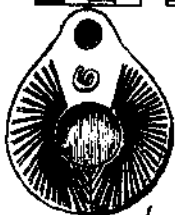

No. 168



No. 220



No. 159

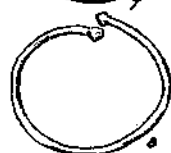
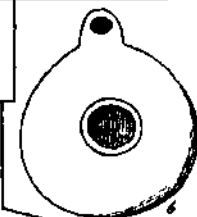
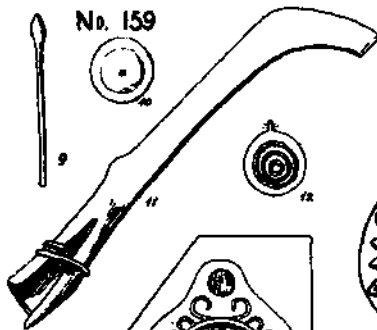

No. 10



No. 33



No. 154

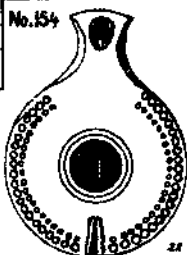

No. 129

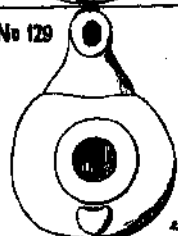

TOMB No. 193

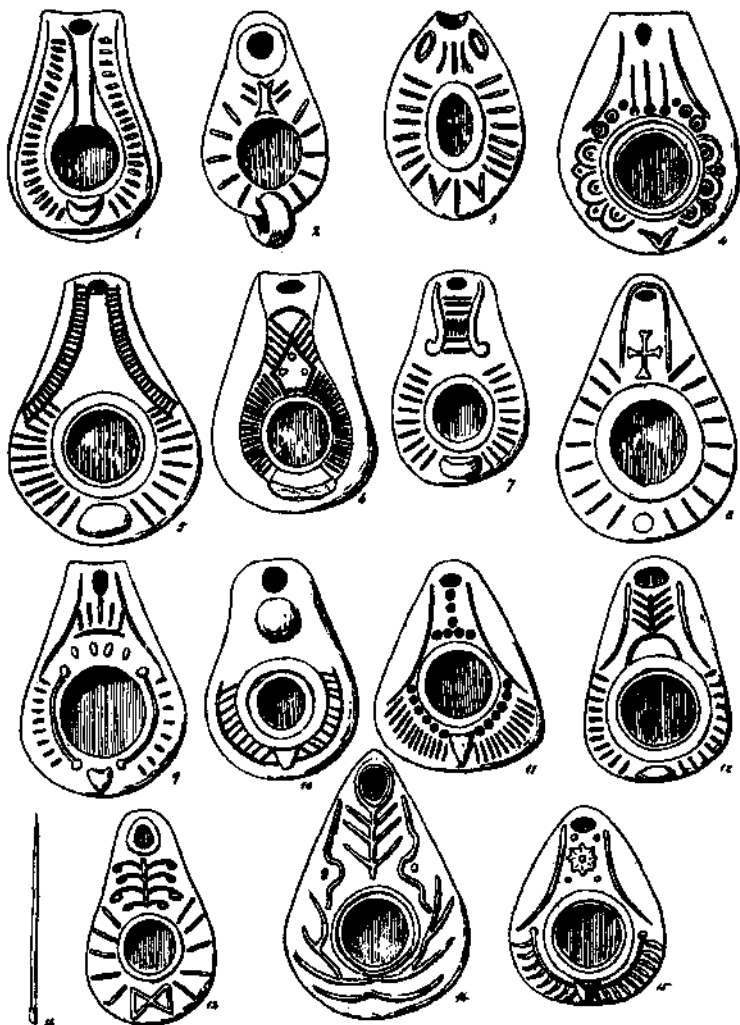
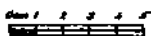
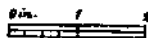









TOMB DEPOSITS

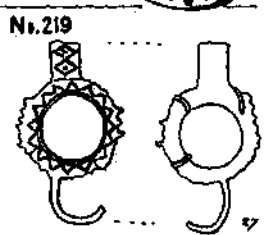
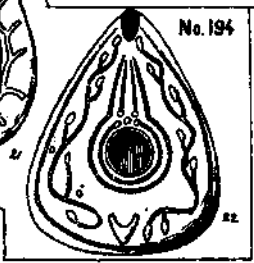
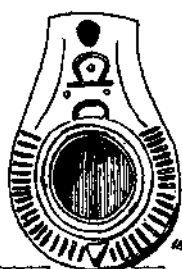
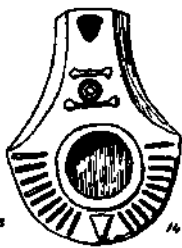
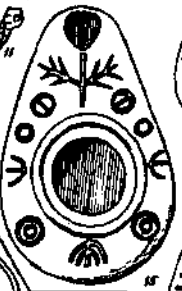
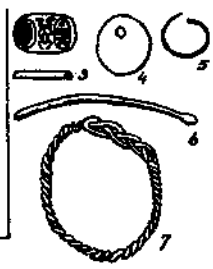
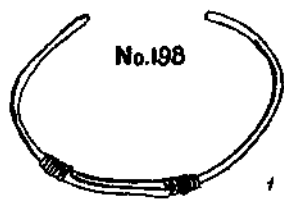

TOMB DEPOSITS

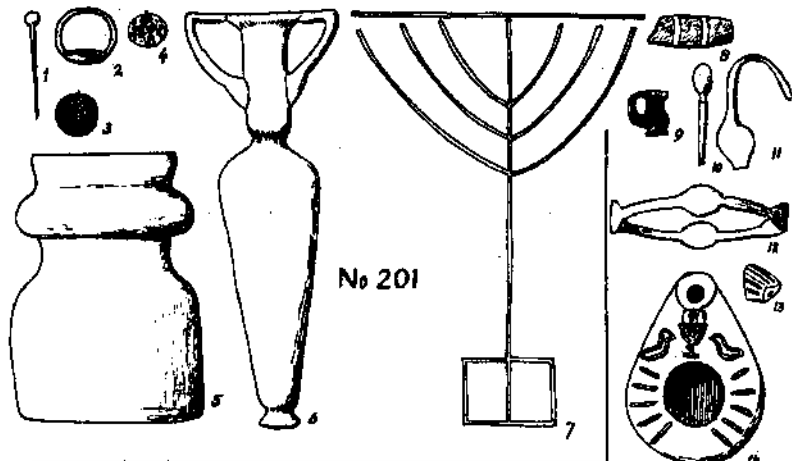

No 201

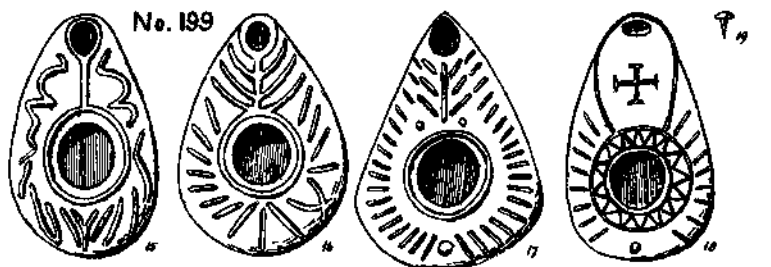

No. 199

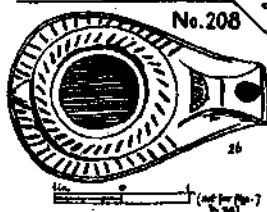
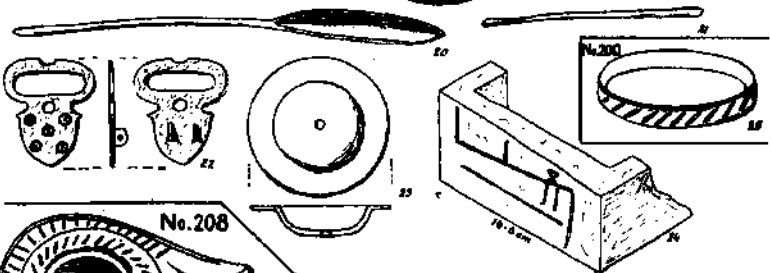

No. 208

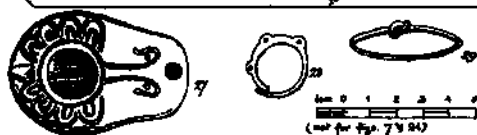

(not for fig. 79 84)





TOMB DEPOSITS

No. 226

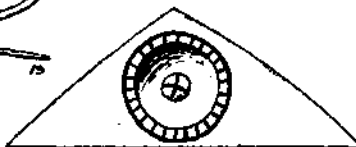
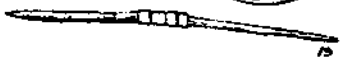
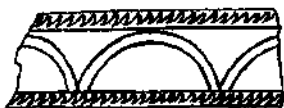
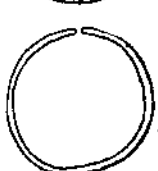
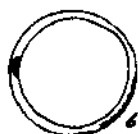
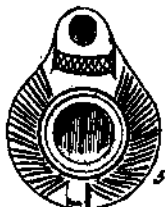
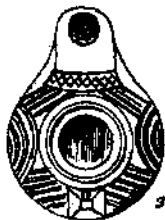
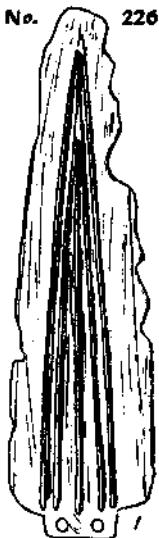

No. 125

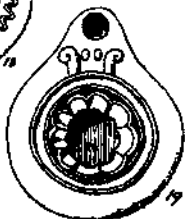
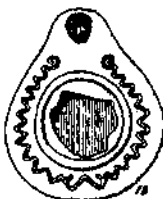
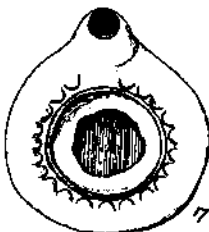

No. 223



TOMB No. 252

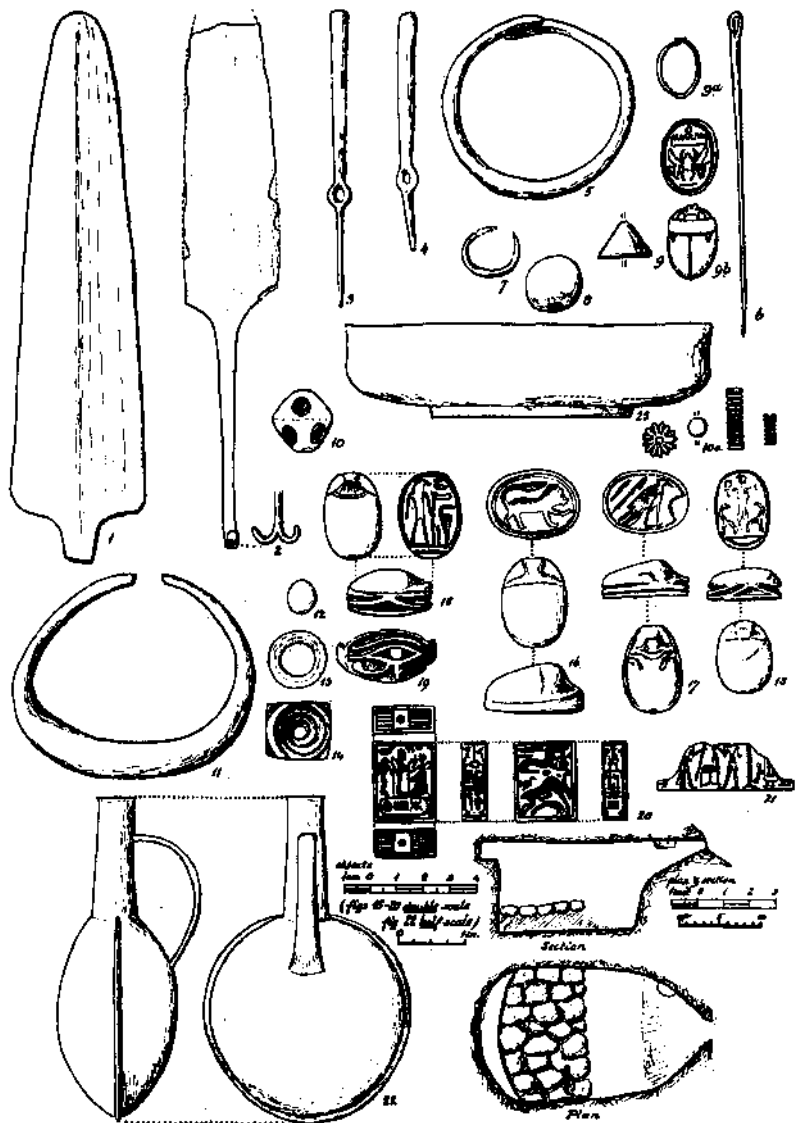



TOMB No. 252

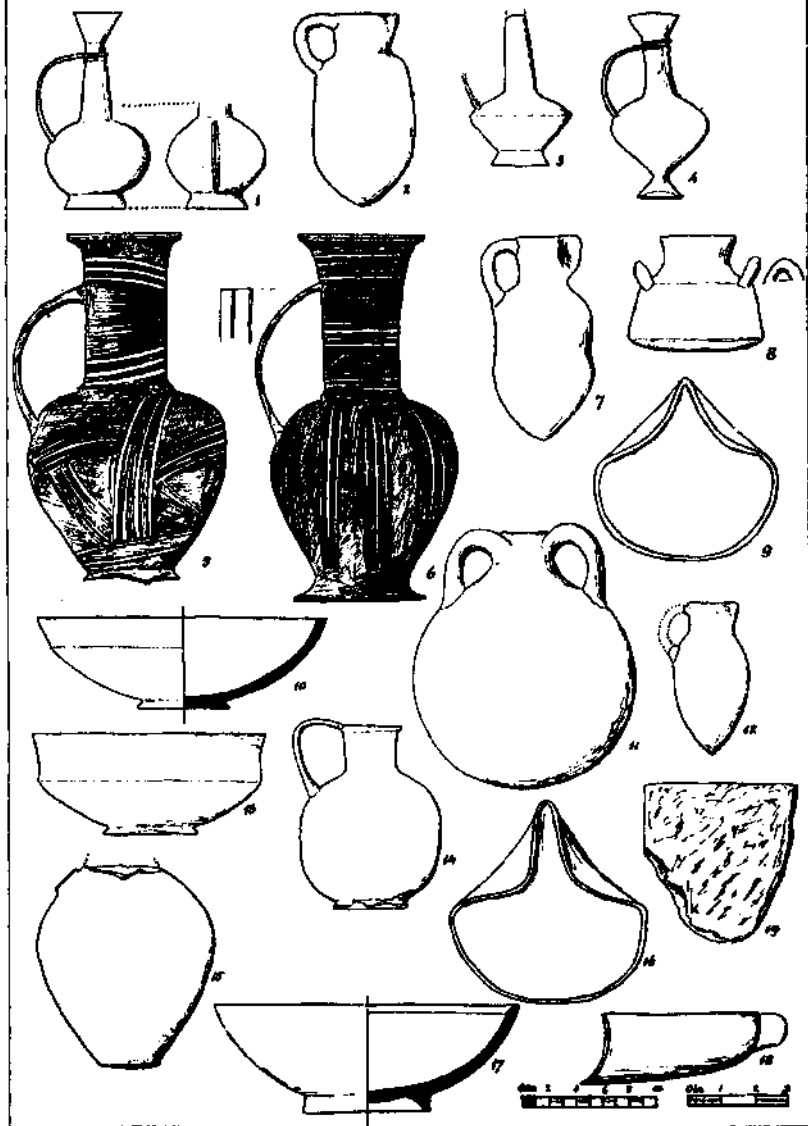



GLASS VASES

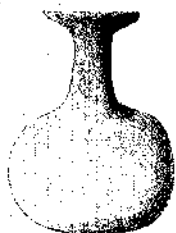

1  
(tomb 201)



2  
(tomb 201)

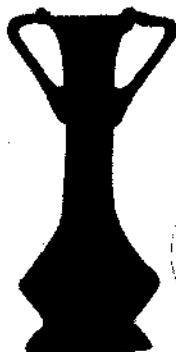

3 (tomb 205)

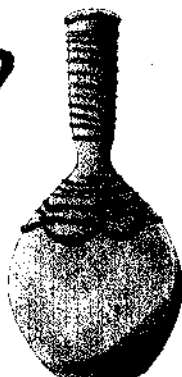

4 (tomb 155)

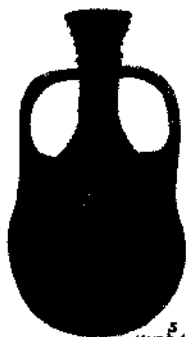

5  
(tomb 155)

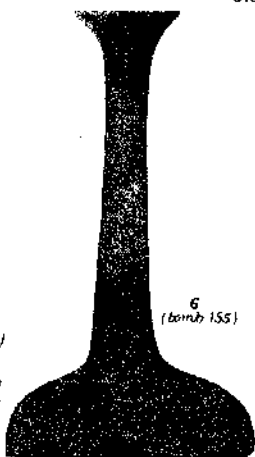

6  
(tomb 155)

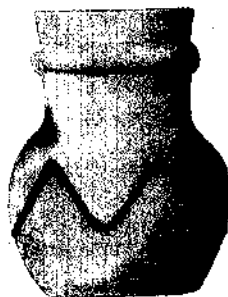

7 (tomb 155)

0 cm 1 2 3

1 2 3 4 5 6 7

0 cm 1 2 3 4 5 6 7





ANIMAL FIGURES - 1.

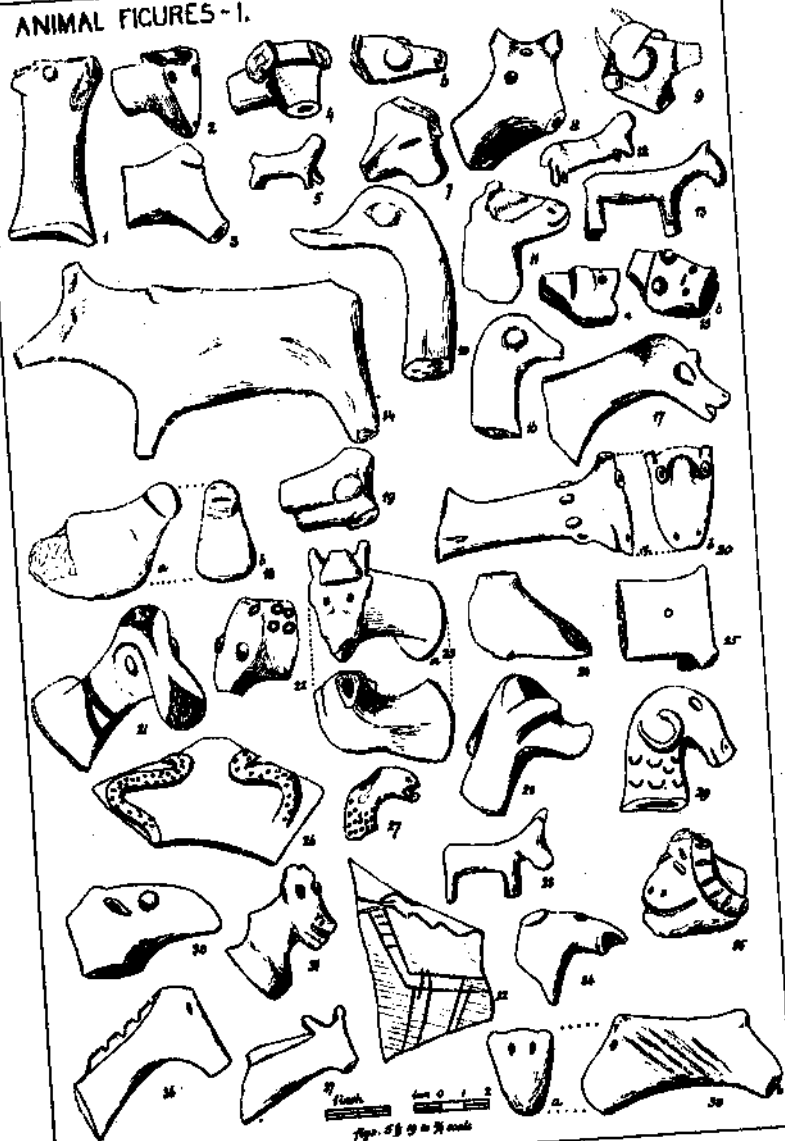

## ANIMAL FIGURES - II





## ANIMAL FIGURES-III

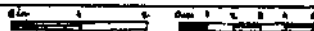

Fig. 6 to 26 and fig. 23 &amp; 24 scale.







AGRICULTURAL IMPLEMENTS

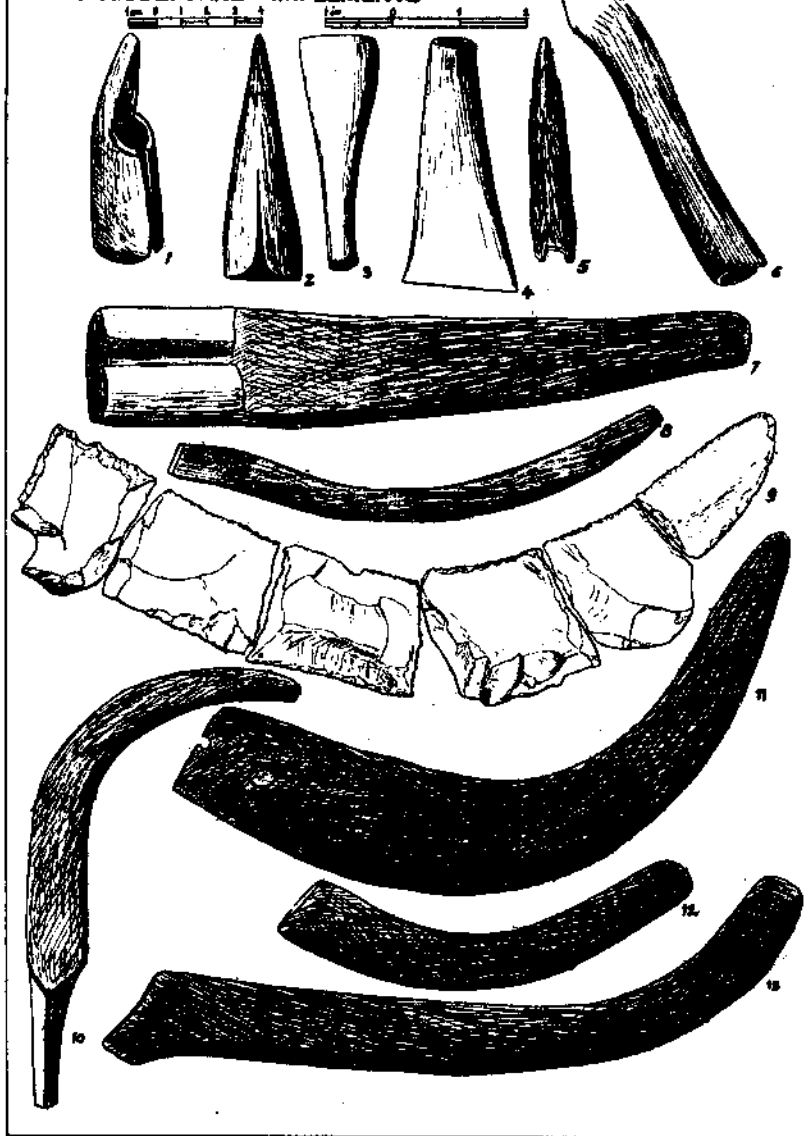

OLIVE-PRESSES

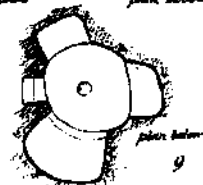
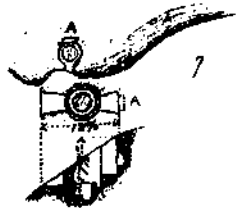
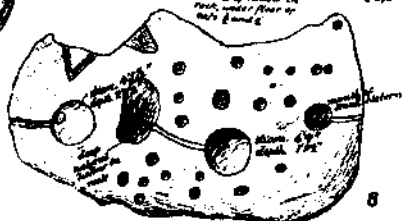
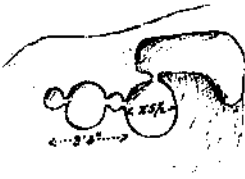
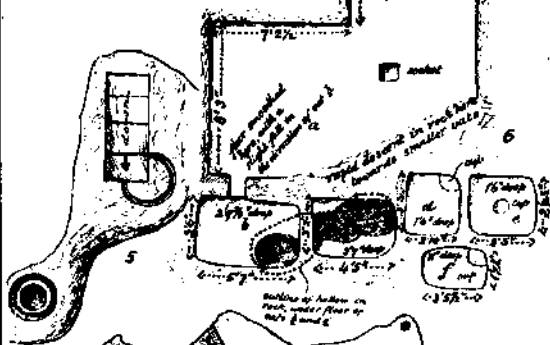
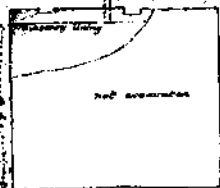
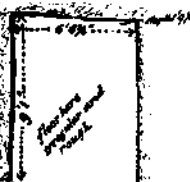
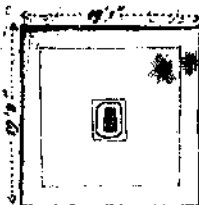



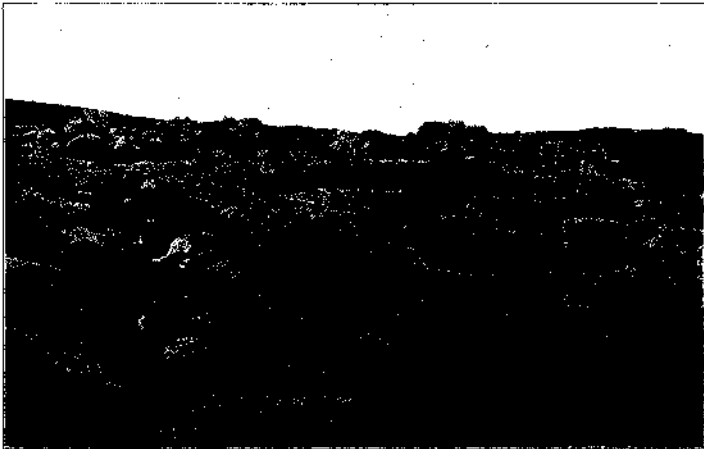
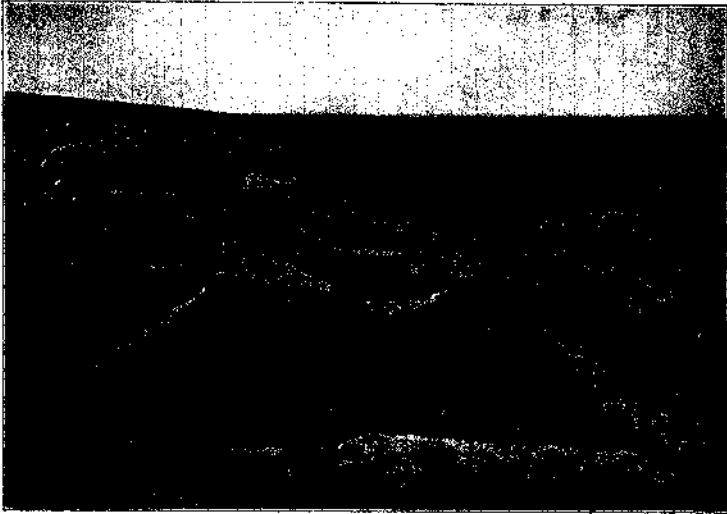

OLIVE-PRESSES OF NORMAL TYPE





**OLIVE-PRESS**  
**ARD 'AIN EL-BUTMEH**

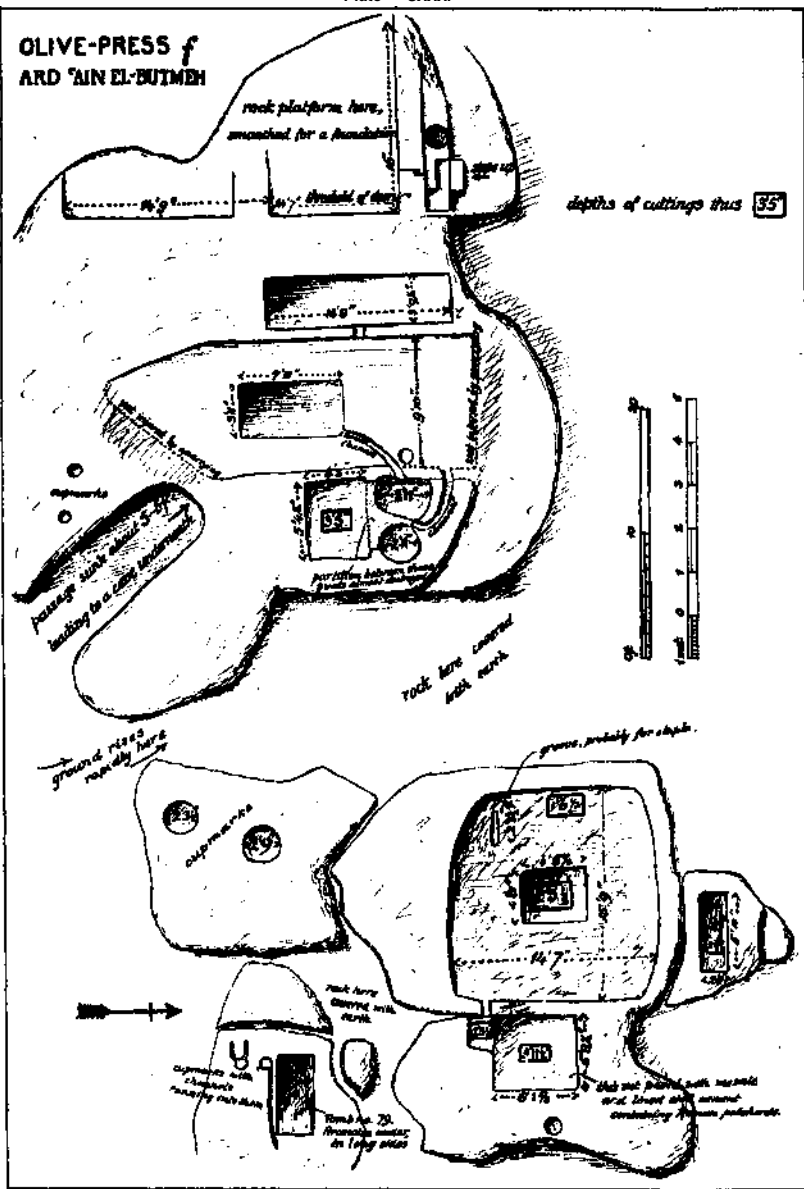

PINDLE-WHORLS AND BUTTONS

tJSk<sub>22</sub>

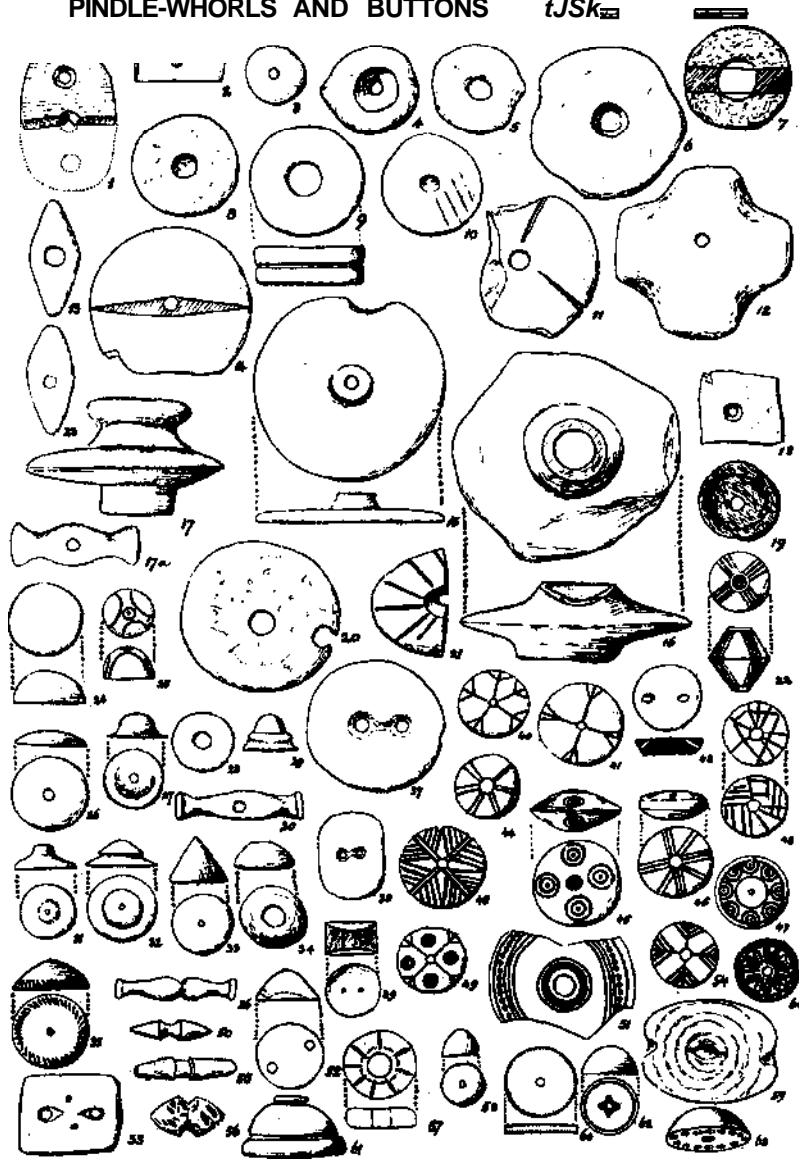





# BRONZE PINS AND NEEDLES

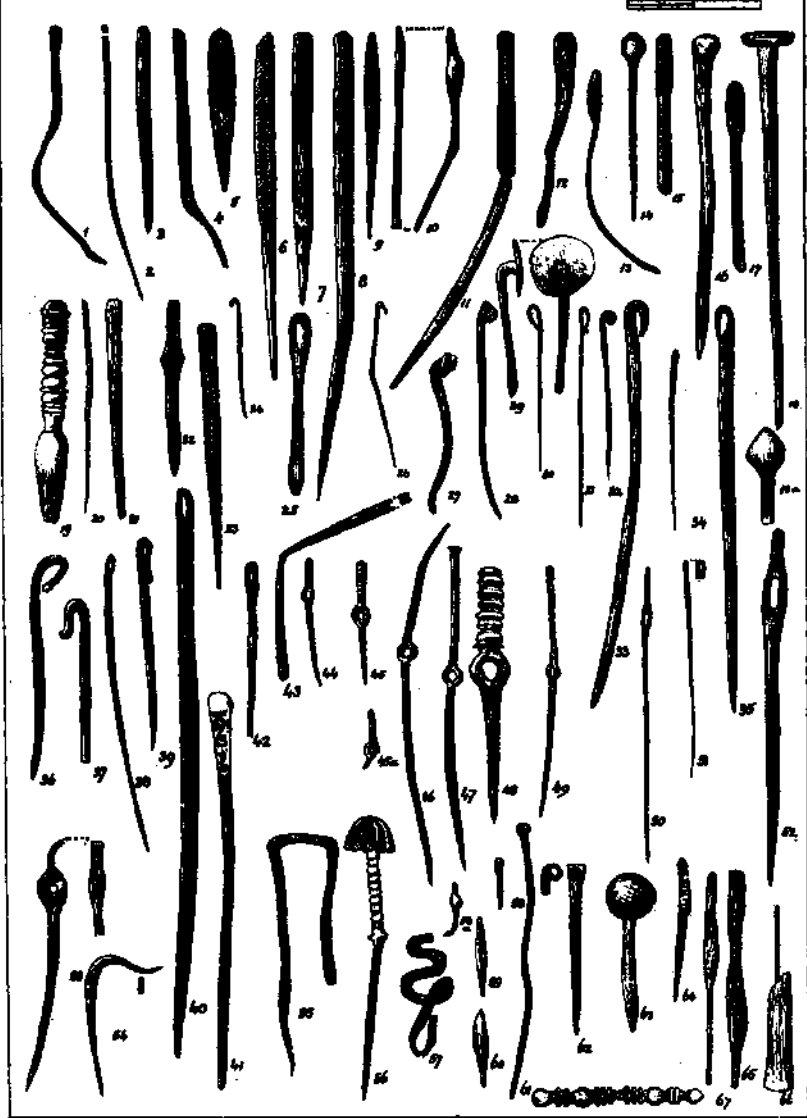
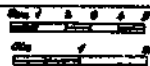

FIBULÆ &c

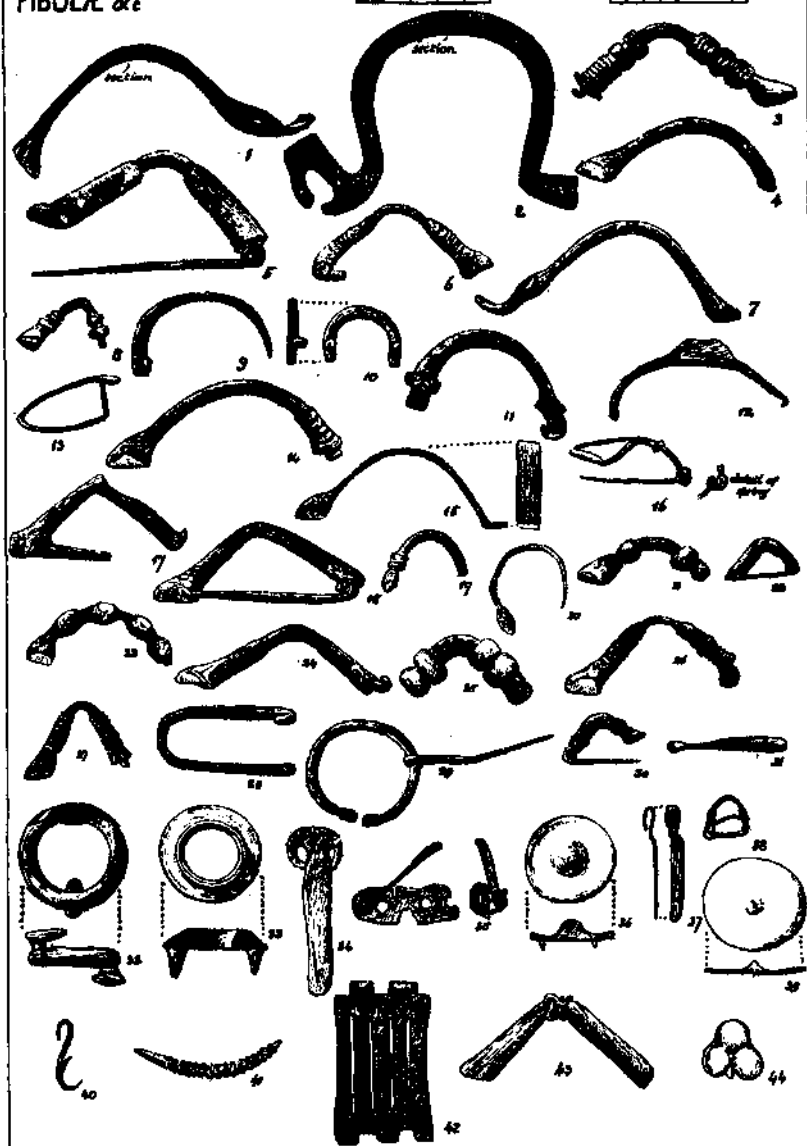





## BRONZE ORNAMENTS &amp;c

4 cm 1 2 3 4      6 cm 1 2 3 4  
 Fig. 4 is  $9\frac{1}{2}$ " (23 cm.) long



SILVER AND GOLD (1-9 A, 10-18 A, 12 E)

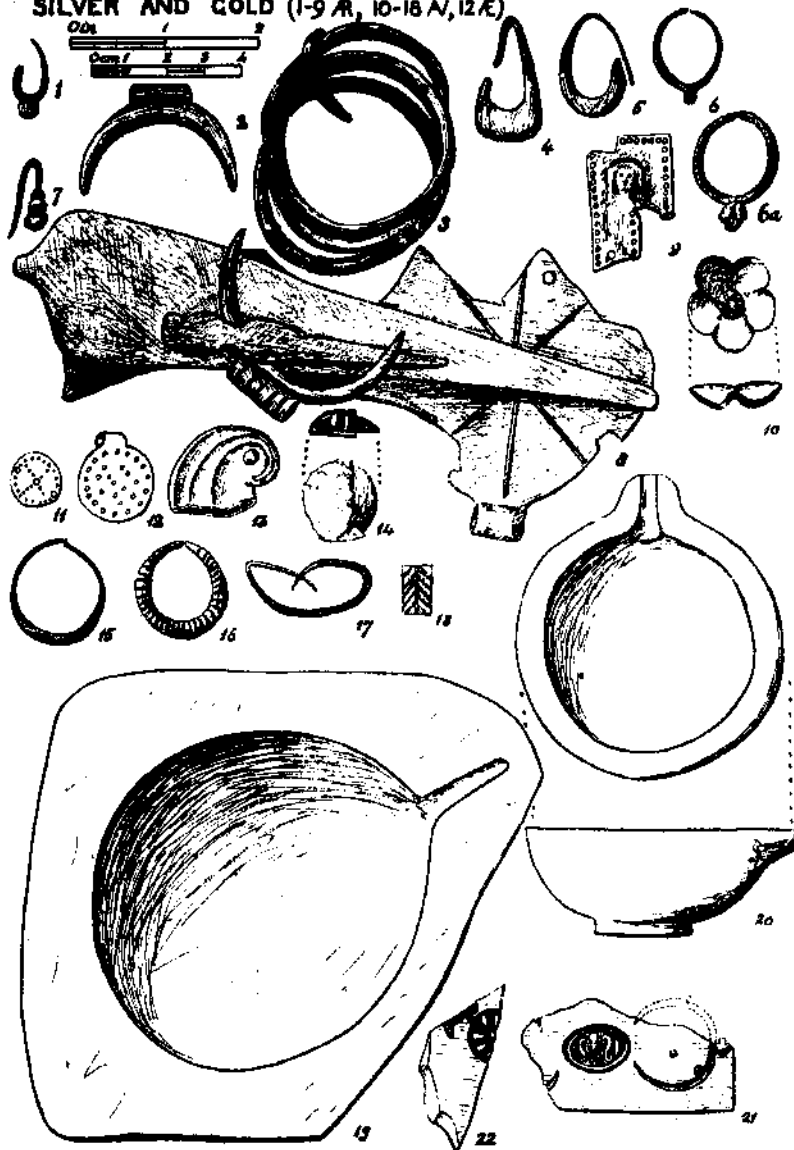





BEADS

1 cm. 0 1 2 3 4  
 1 cm. 0 1 2 3 4  
 for width, edge, & double width

(a)

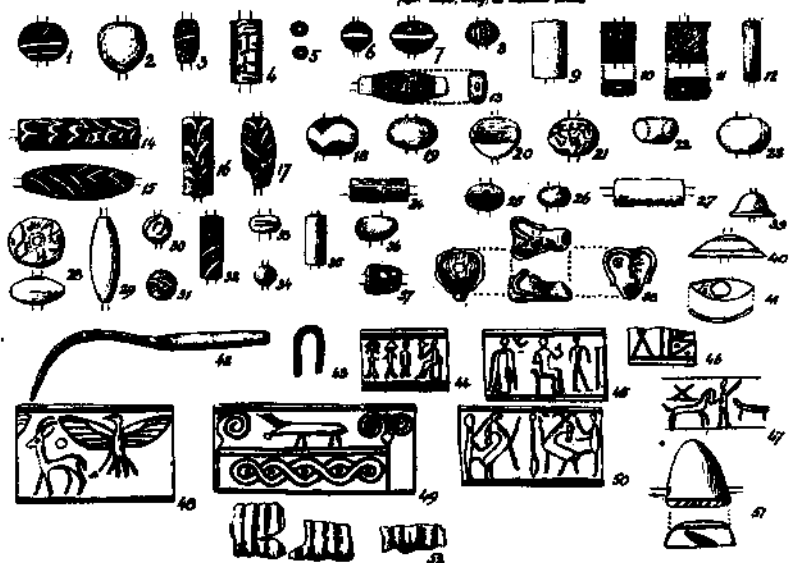

(b)

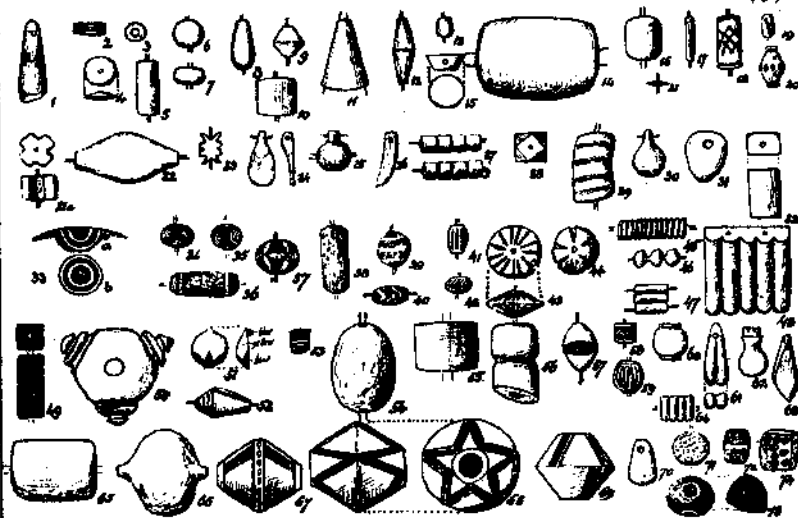

FLINT IMPLEMENTS

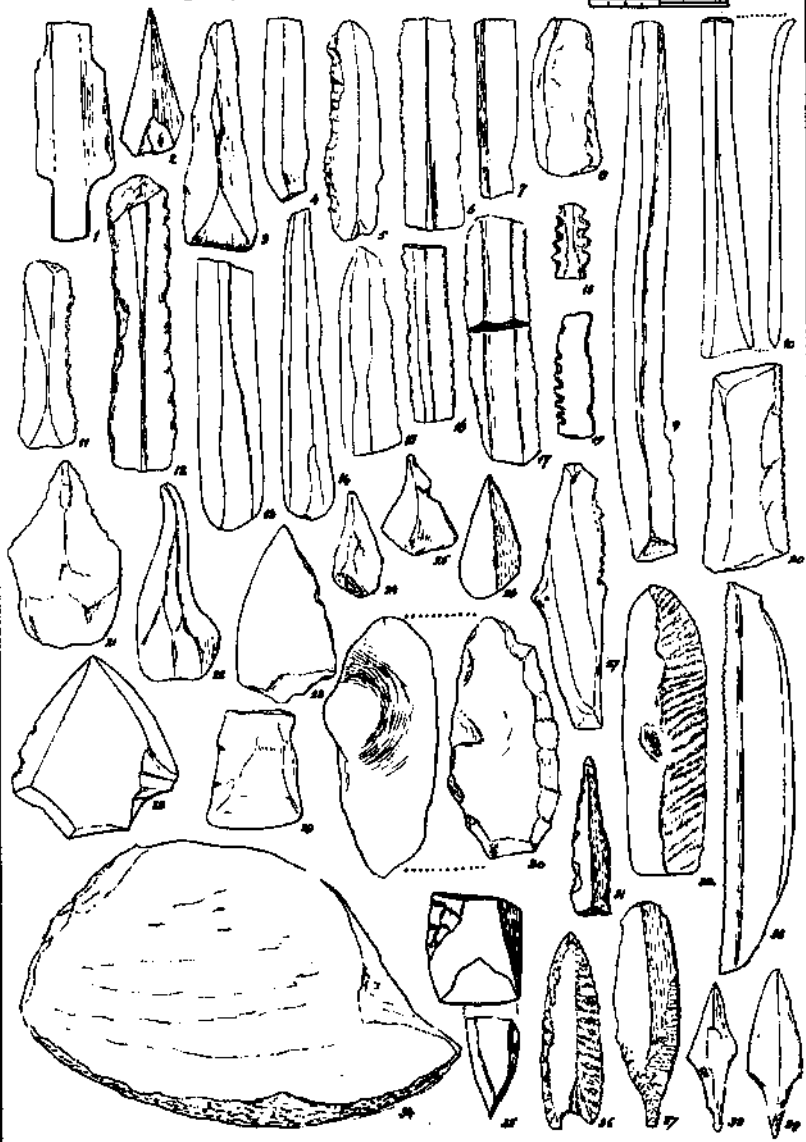



## FLINT IMPLEMENTS

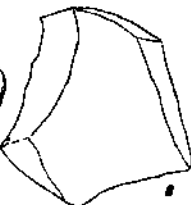
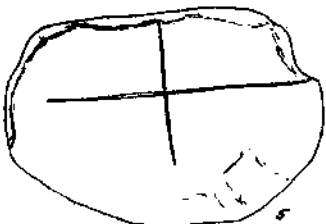

11



12



13



14



15

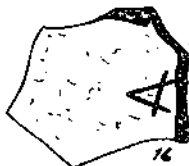

16



17



18



19



20



21



22



23



POTTERY: COLOUR DECORATION (VARIOUS PERIODS)

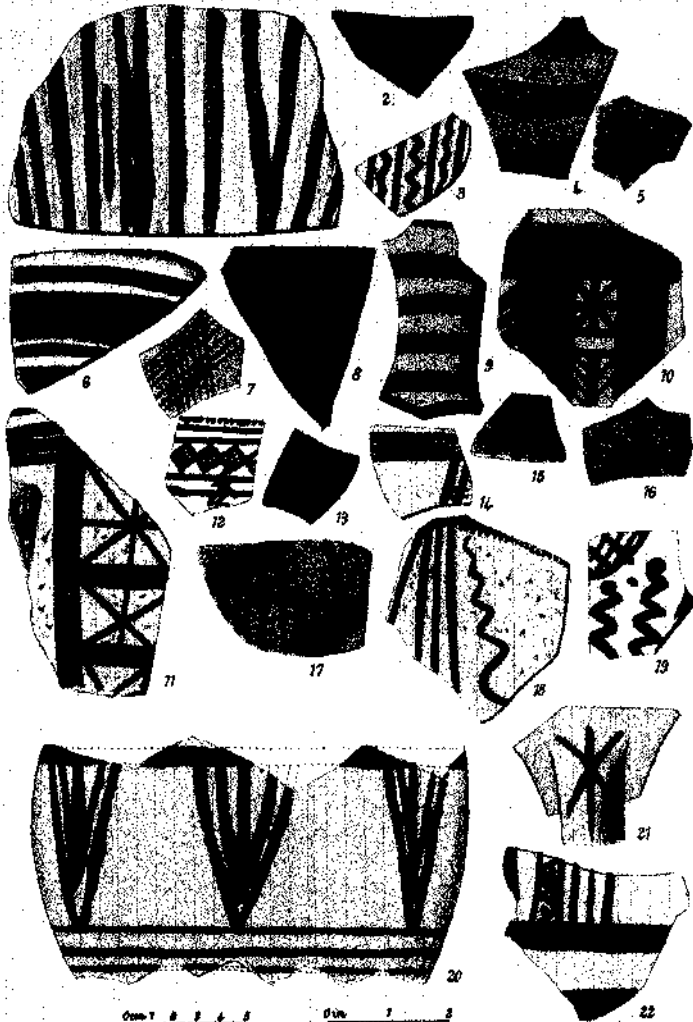





FIRST SEMITIC POTTERY

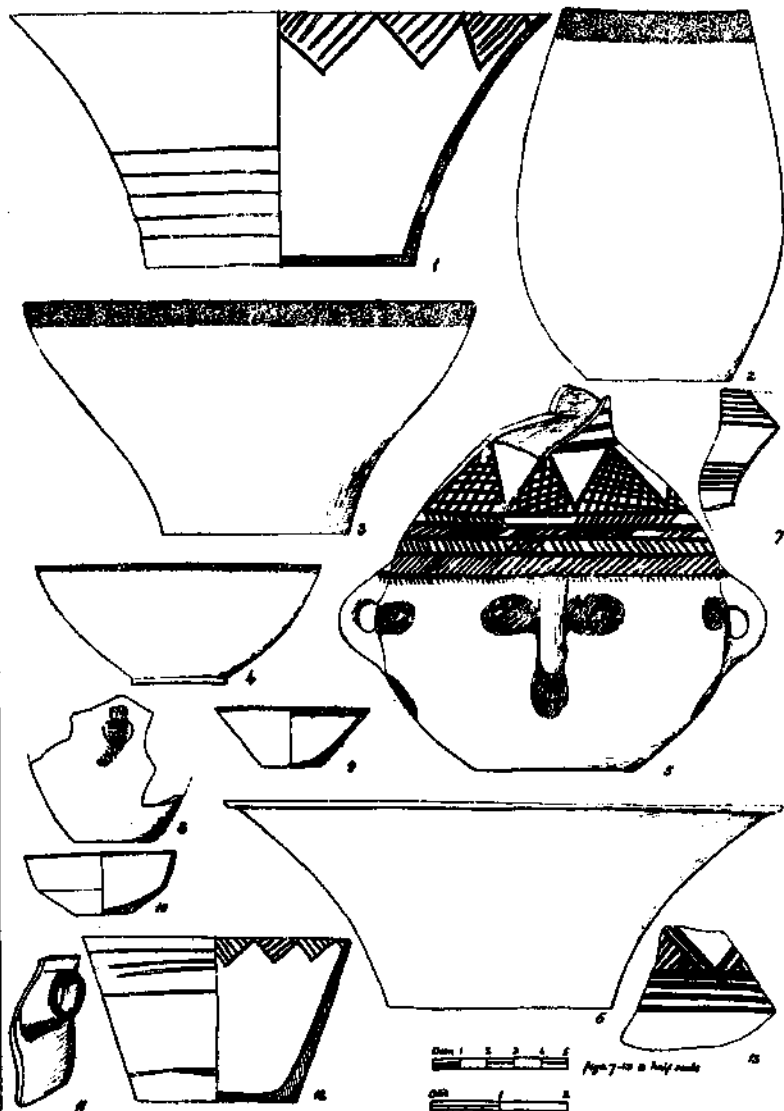

FIRST SEMITIC POTTERY

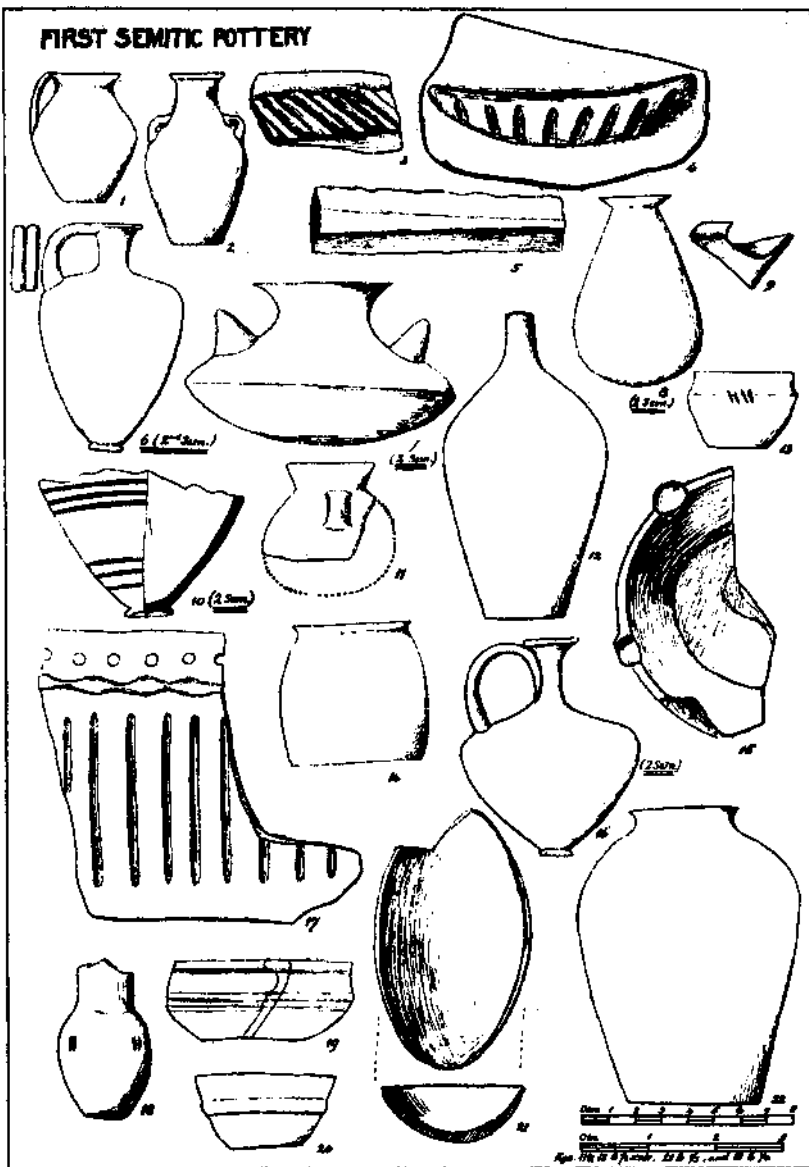





FIRST SEMITIC POTTERY

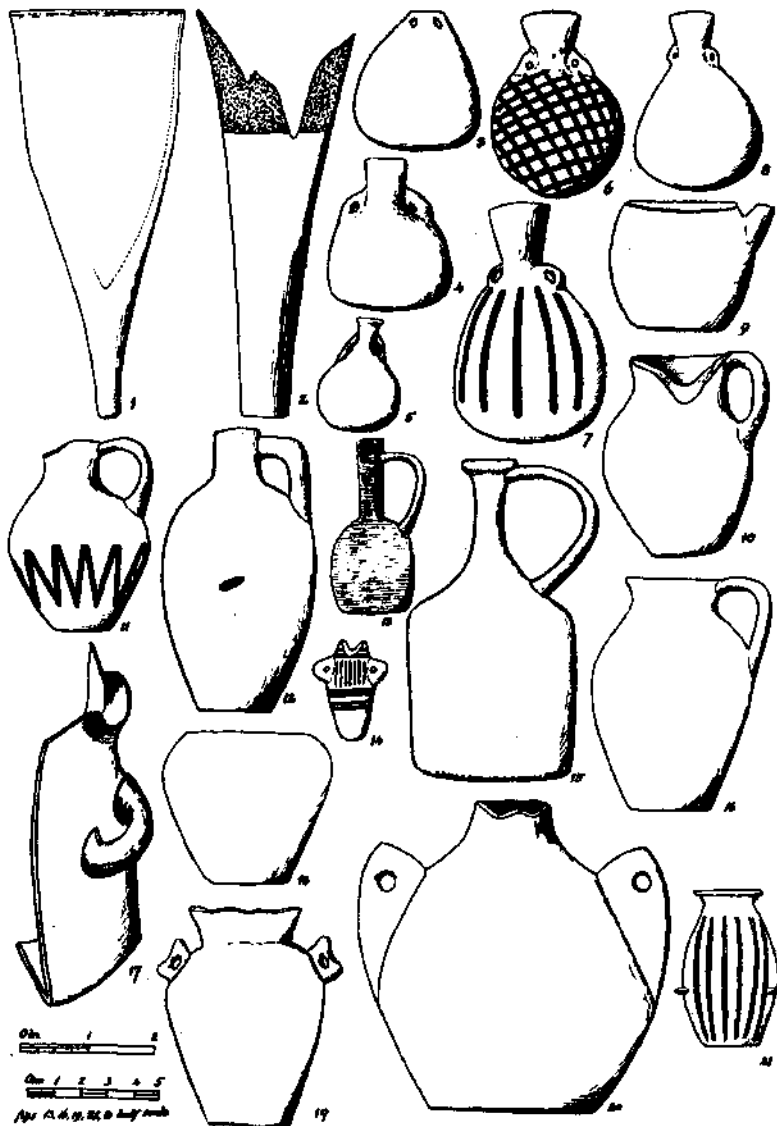

FIRST SEMITIC POTTERY









# FIRST SEMITIC POTTERY

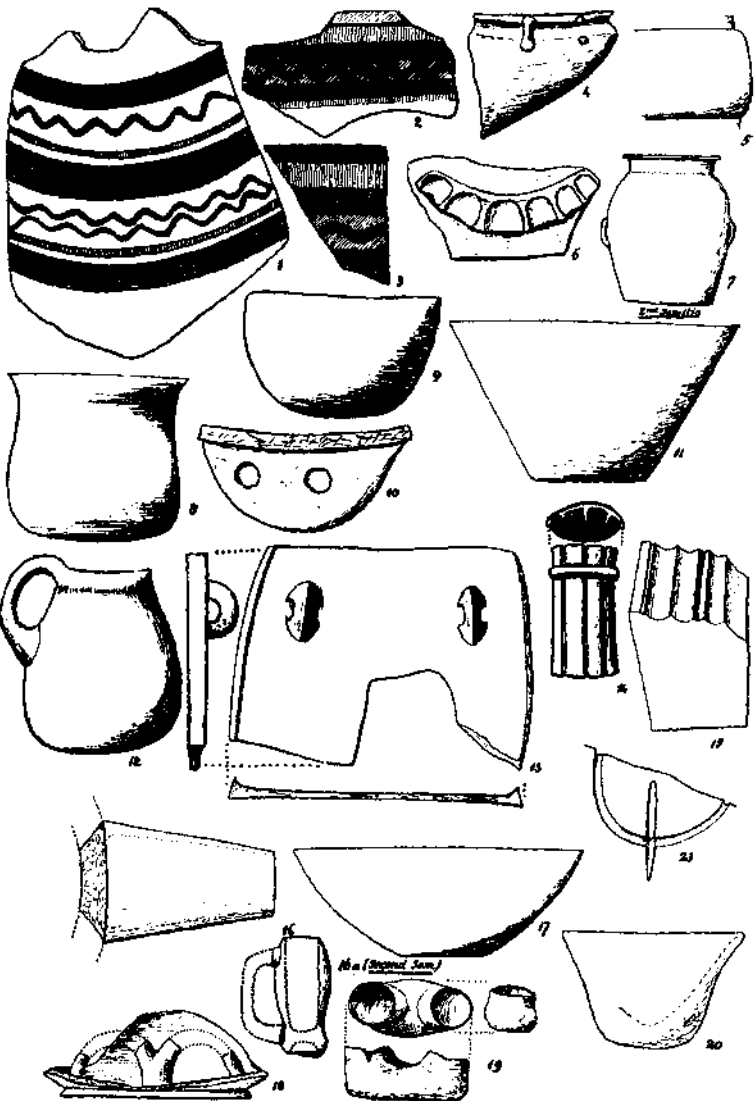





FIRST SEMITIC POTTERY

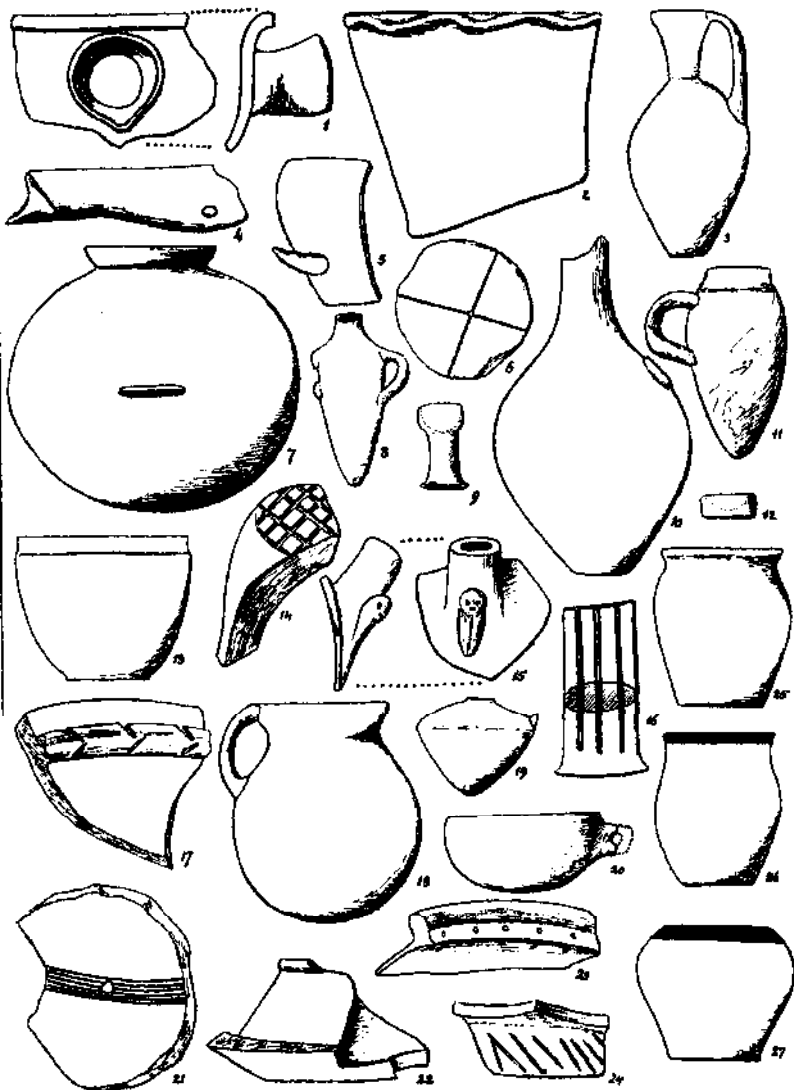

FIRST SEMITIC POTTERY

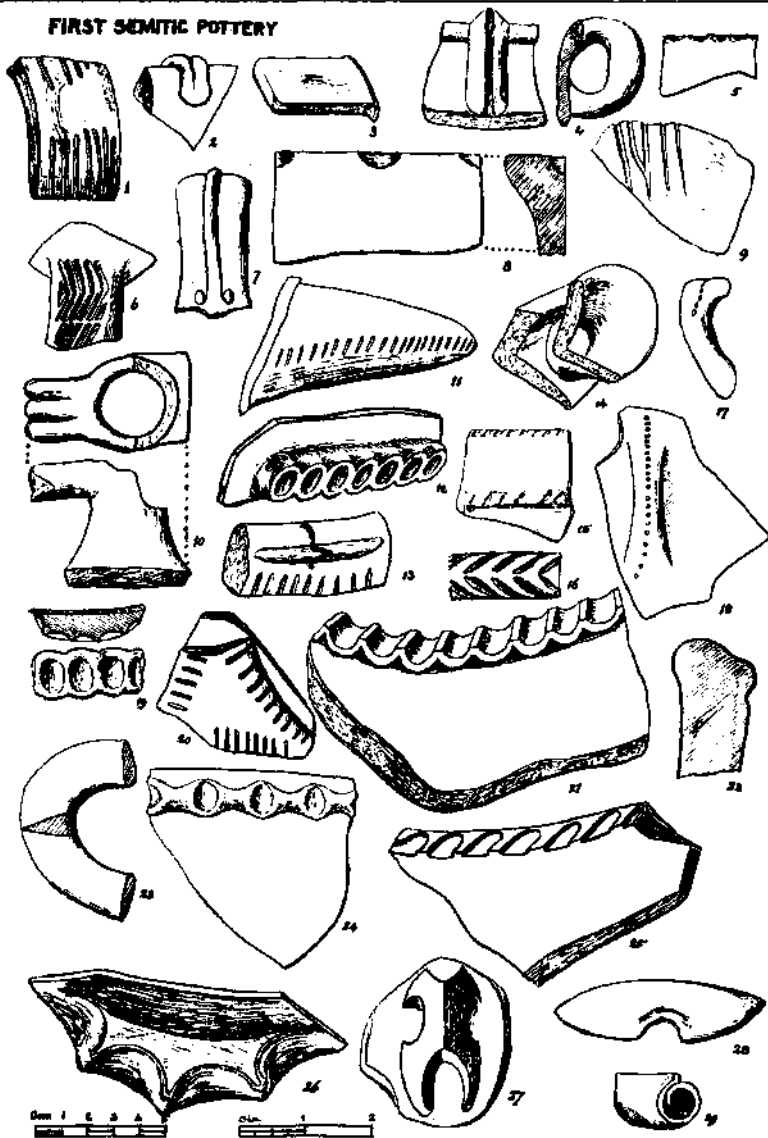

Scale 1 2 3 4  
 Scale 1 2  
 figs. 1, 2, 4, 6, 8 to 1/2 inch; fig. 29 to a slightly enlarged scale





FIRST SEMITIC POTTERY

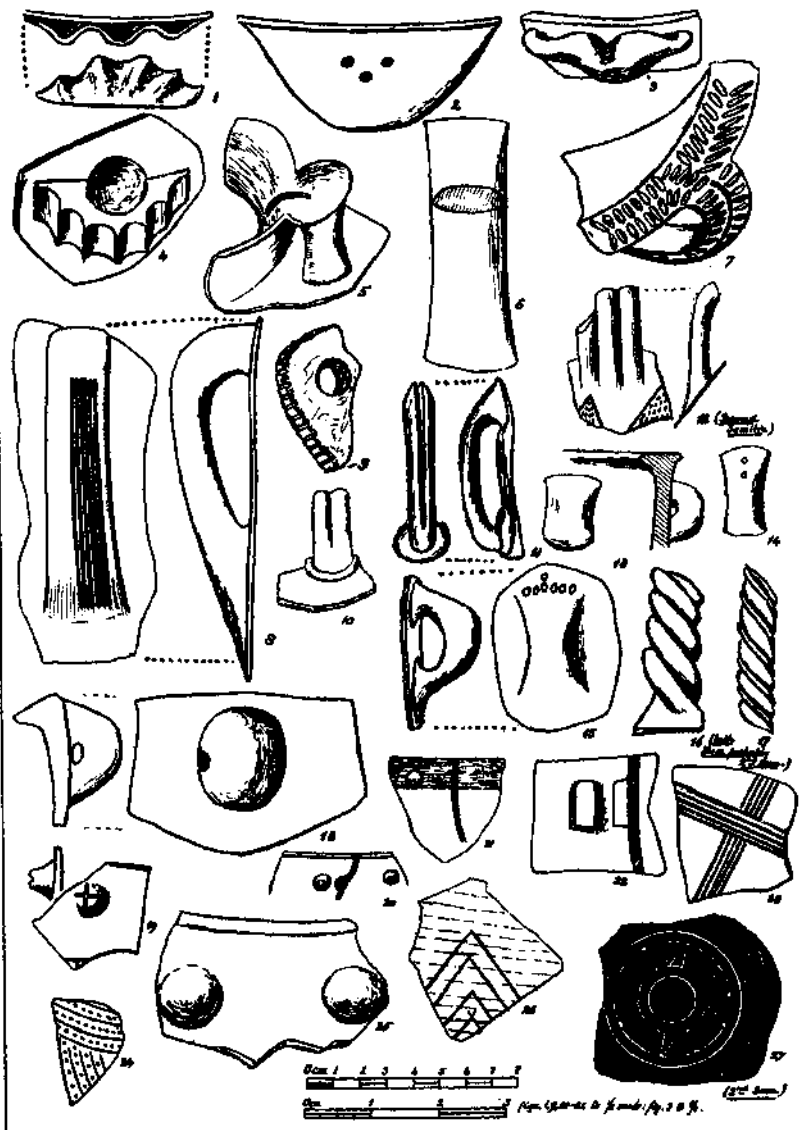

FIRST SEMITIC POTTERY

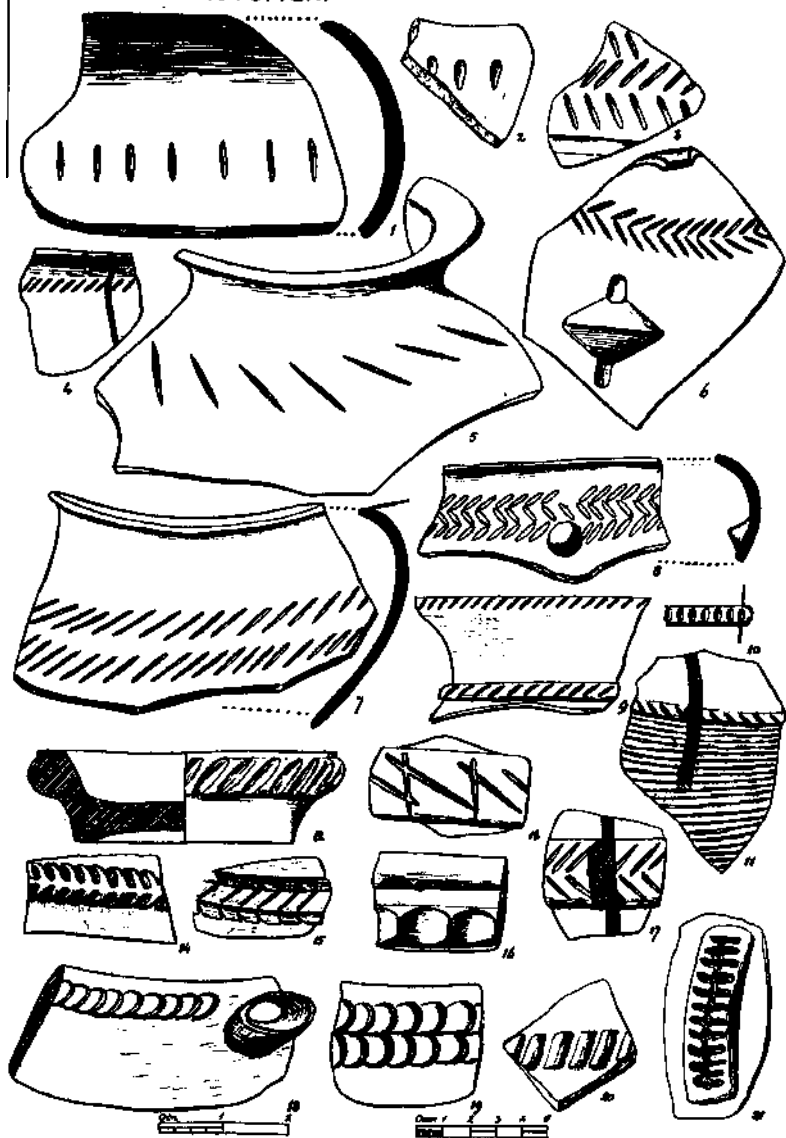





## OCEAN POTSHERDS

Fig. 6 to 7, - fig. 19 to 24 made



SECOND SEMITIC POTTERY

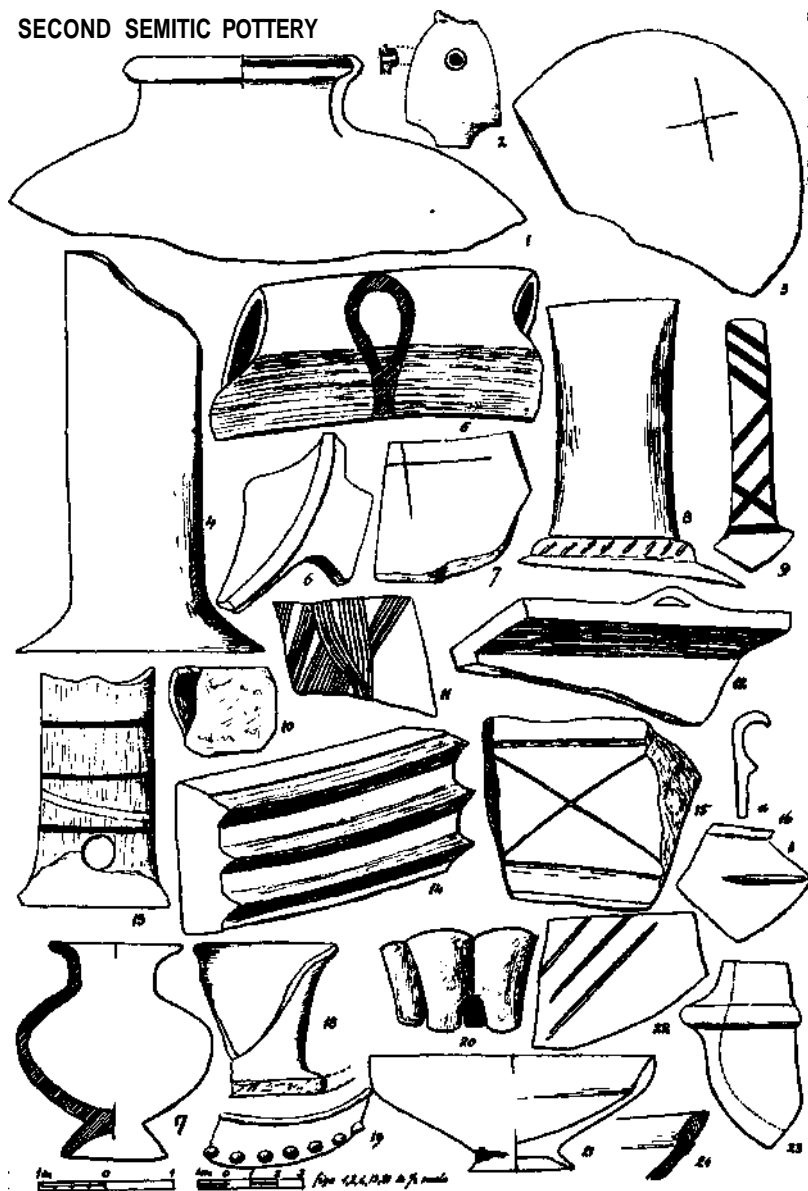





## SECOND SEMITIC POTTERY



Figs. 1, 2, 3, 4, 5, 6, 7, 8, 9, 10, 11, 12, 13, 14, 15, 16, 17, 18, 19, 20, 21, 22

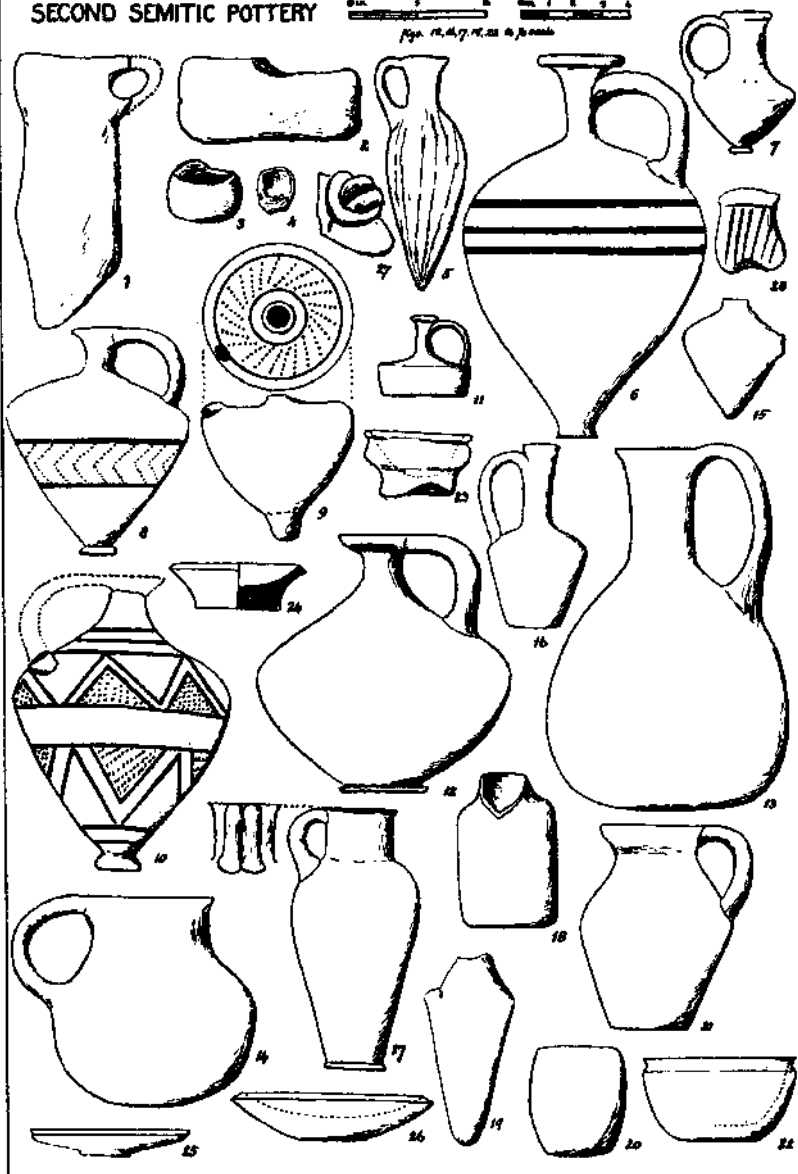

## SECOND SEMITIC POTTERY

0 in.	1	2	3	4
0 cm.	1	2	3	4

Figs. 1, 6, 7, 11, 12, 15, 22, 23, 24, 25, 26, 27, 28, 29, 30, 31, 32, 33, 34, 35, 36, 37, 38, 39, 40, 41, 42, 43, 44, 45, 46, 47, 48, 49, 50, 51, 52, 53, 54, 55, 56, 57, 58, 59, 60, 61, 62, 63, 64, 65, 66, 67, 68, 69, 70, 71, 72, 73, 74, 75, 76, 77, 78, 79, 80, 81, 82, 83, 84, 85, 86, 87, 88, 89, 90, 91, 92, 93, 94, 95, 96, 97, 98, 99, 100

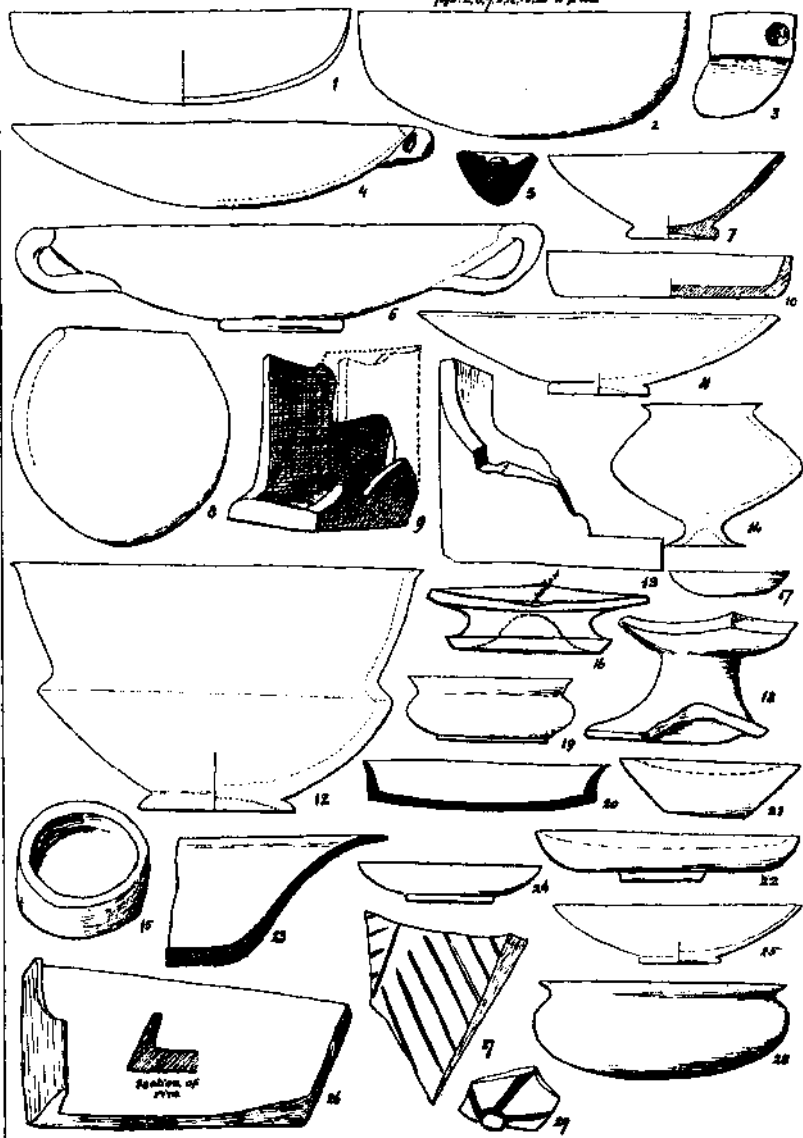





## SECOND SEMITIC POTTERY

A scale bar with markings for centimeters (0 to 10) and inches (0 to 1).

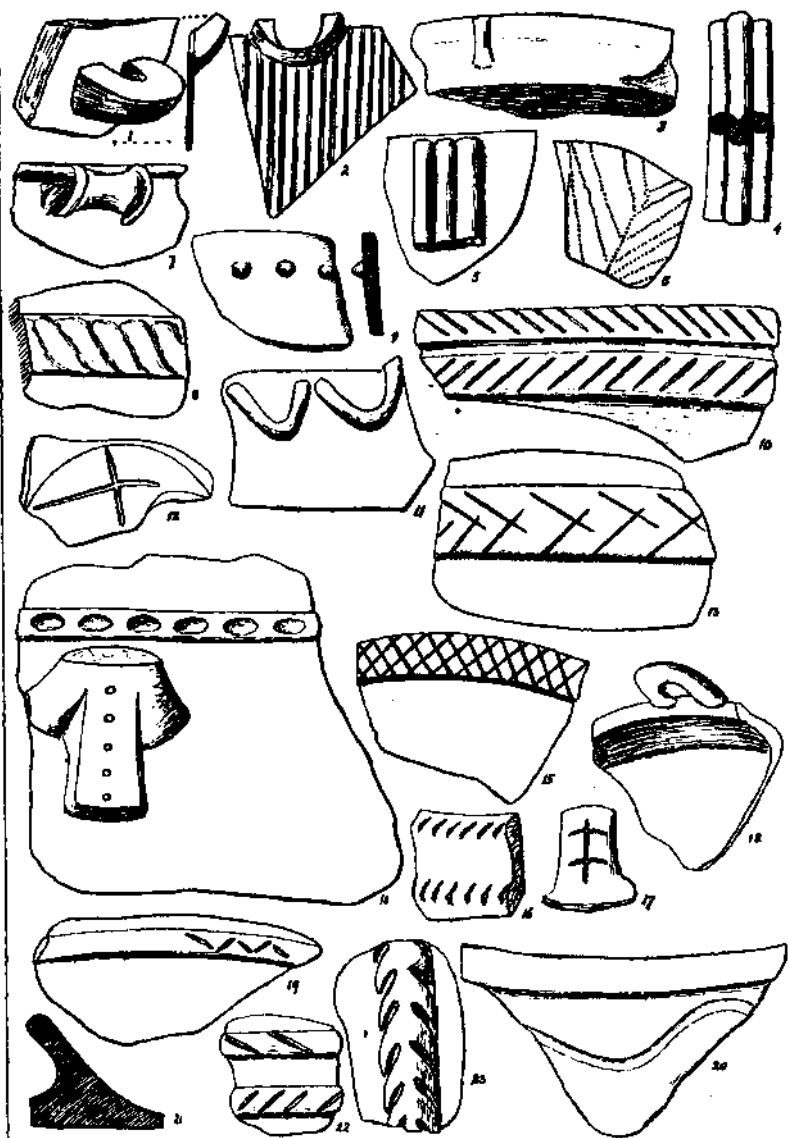

SECOND SEMITIC POTTERY



Fig. 1, 2, 3, 4, 5, 6, 7, 8, 9, 10, 11, 12, 13, 14, 15, 16, 17, 18, 19, 20, 21, 22, 23, 24, 25, 26, 27, 28, 29, 30, 31, 32, 33, 34, 35, 36, 37, 38, 39, 40, 41, 42, 43, 44, 45, 46, 47, 48, 49, 50, 51, 52, 53, 54, 55, 56, 57, 58, 59, 60, 61, 62, 63, 64, 65, 66, 67, 68, 69, 70, 71, 72, 73, 74, 75, 76, 77, 78, 79, 80, 81, 82, 83, 84, 85, 86, 87, 88, 89, 90, 91, 92, 93, 94, 95, 96, 97, 98, 99, 100

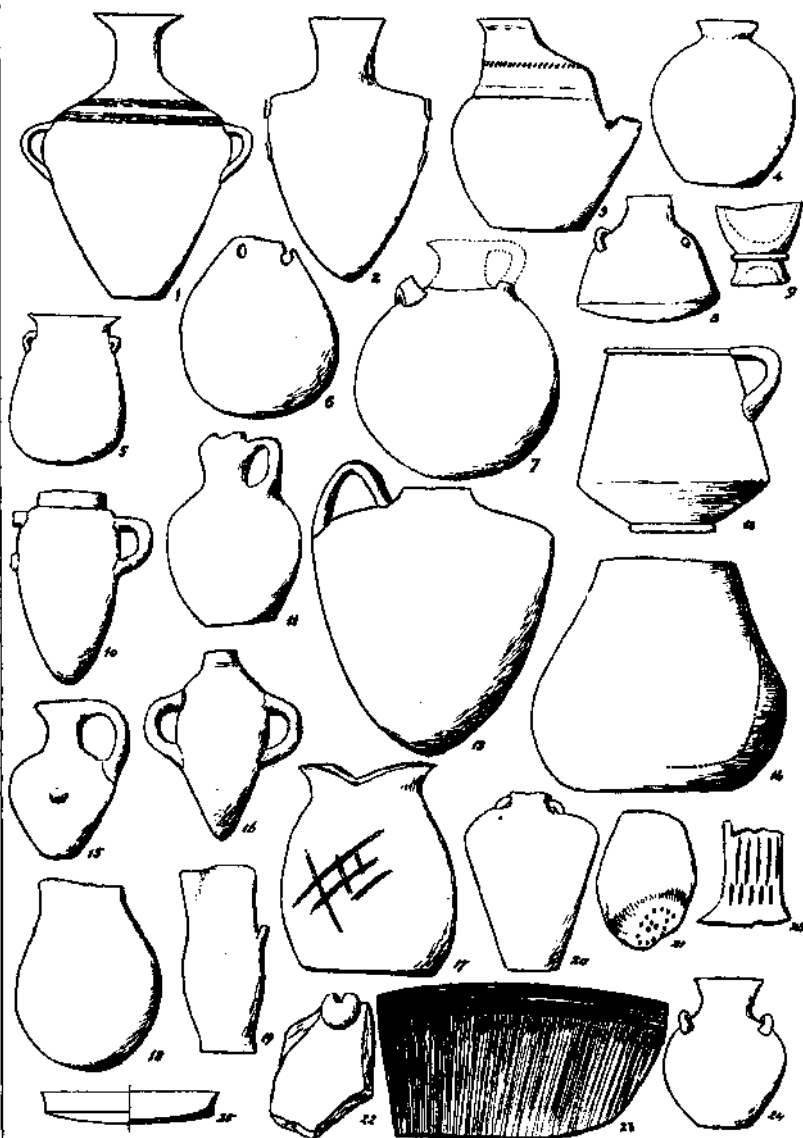





SECOND SEMITIC POTTERY

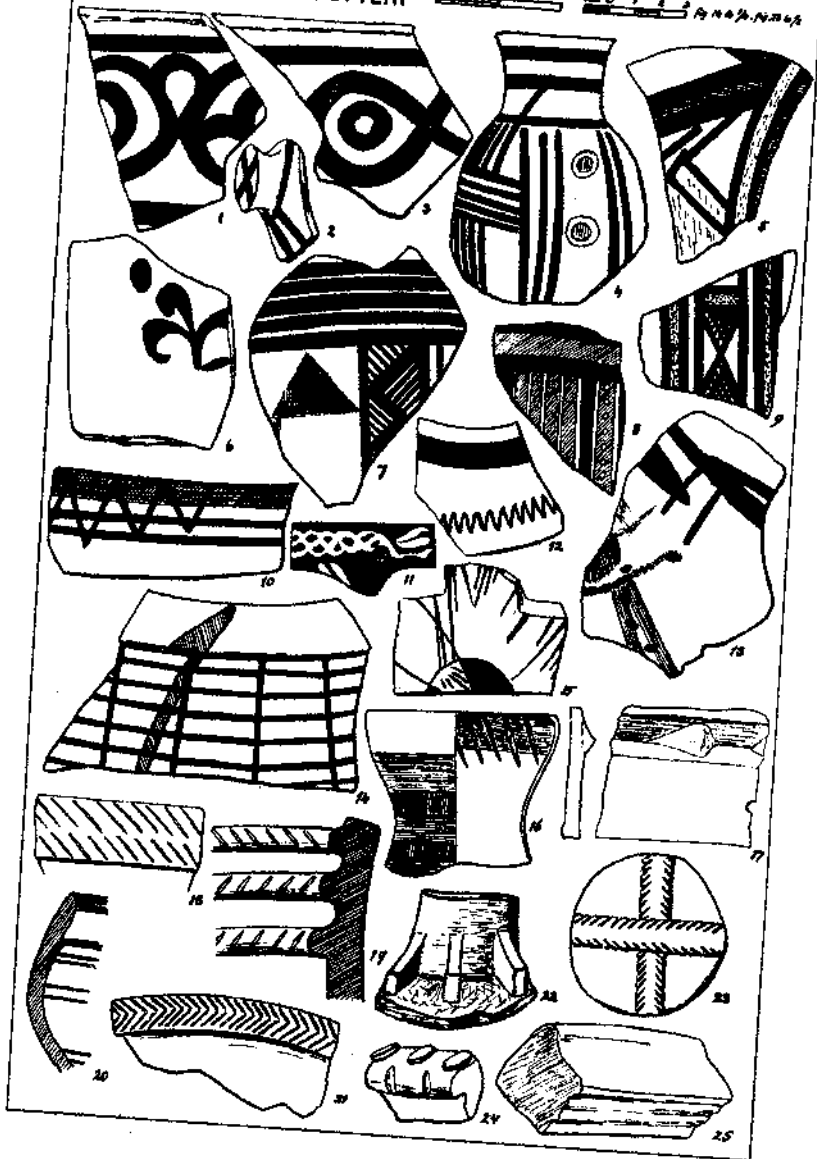
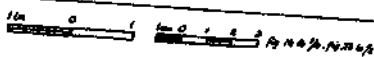

## THIRD SEMITIC POTTERY

1 in 0 1 2 3 4  
 5 cm 0 1 2 3 4  
 figs 1, 3, 7, 9-11, 14, 15, 16, 17: scale: fig. 15 is 6" (20.3 cm) high

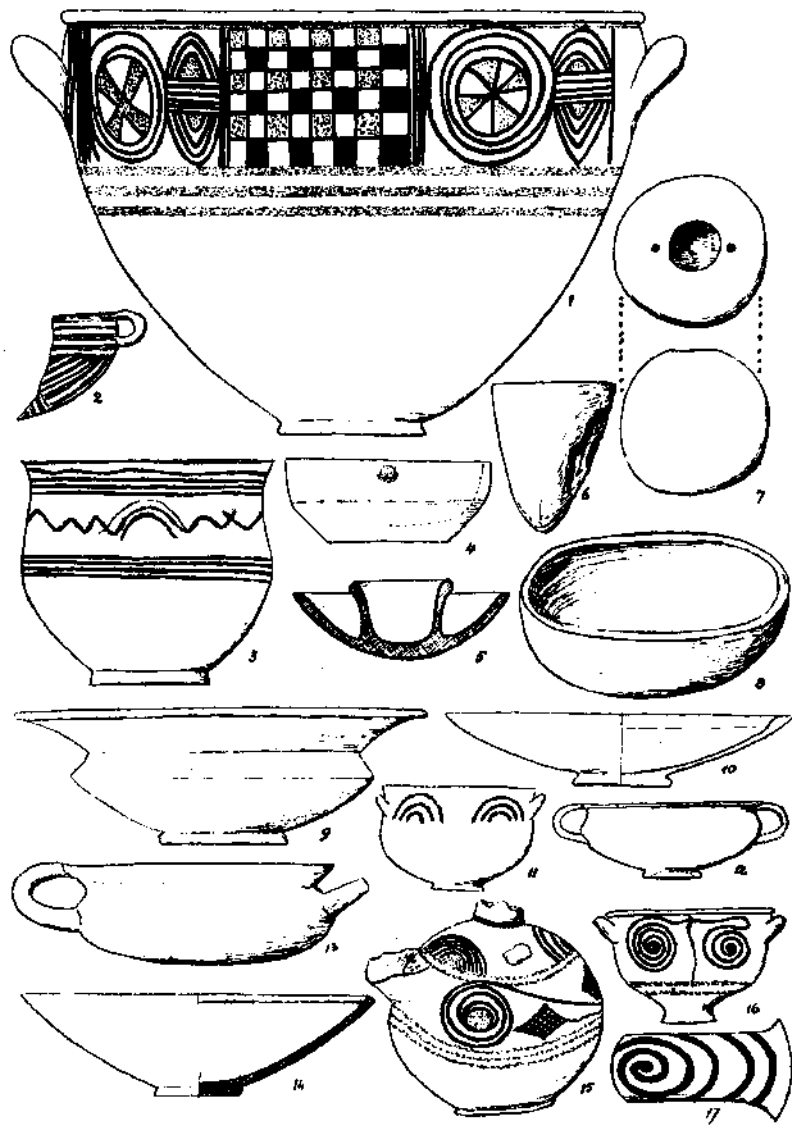



THIRD SEMITIC POTTERY

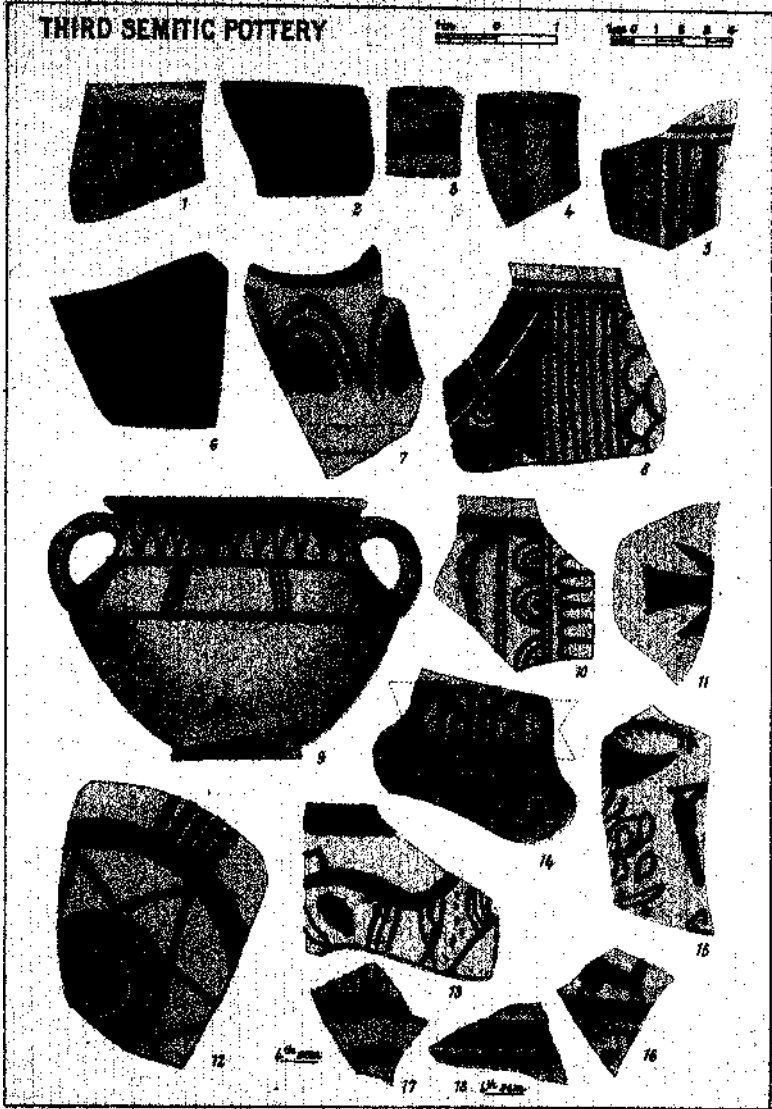
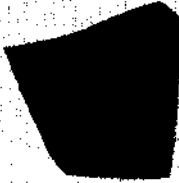





THIRD SEMITIC POTTERY

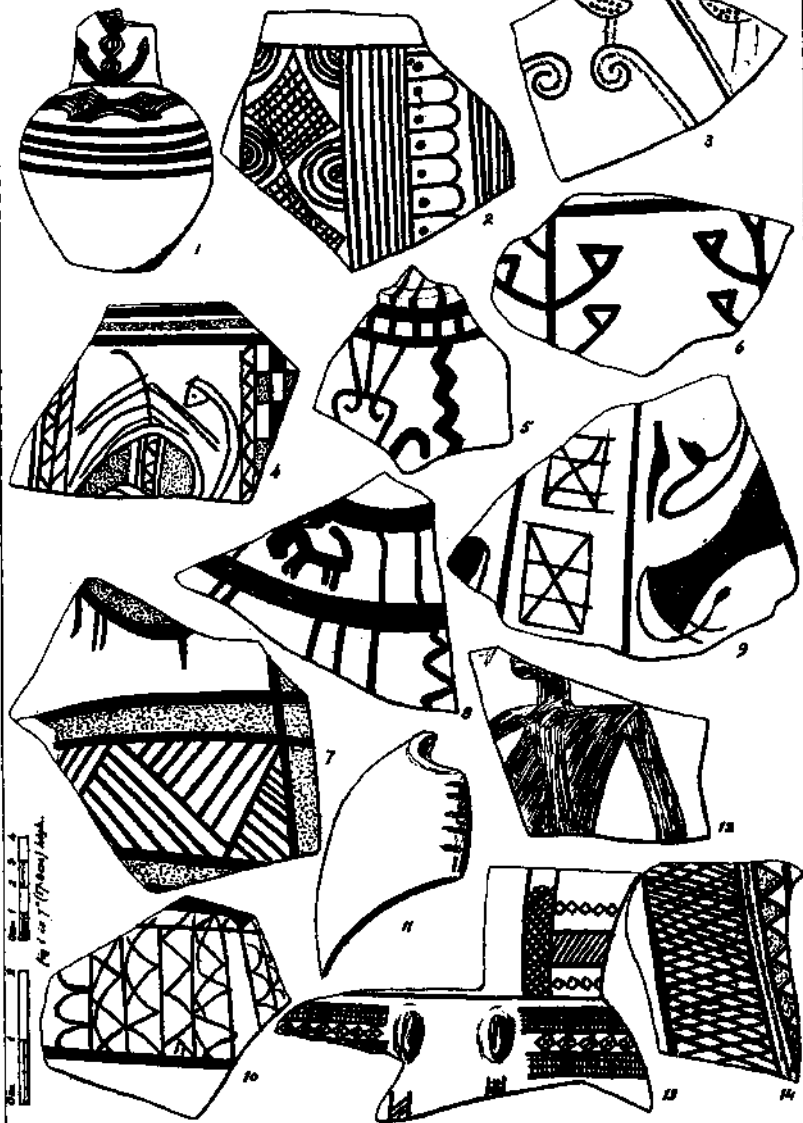

## THIRD SEMITIC POTTERY

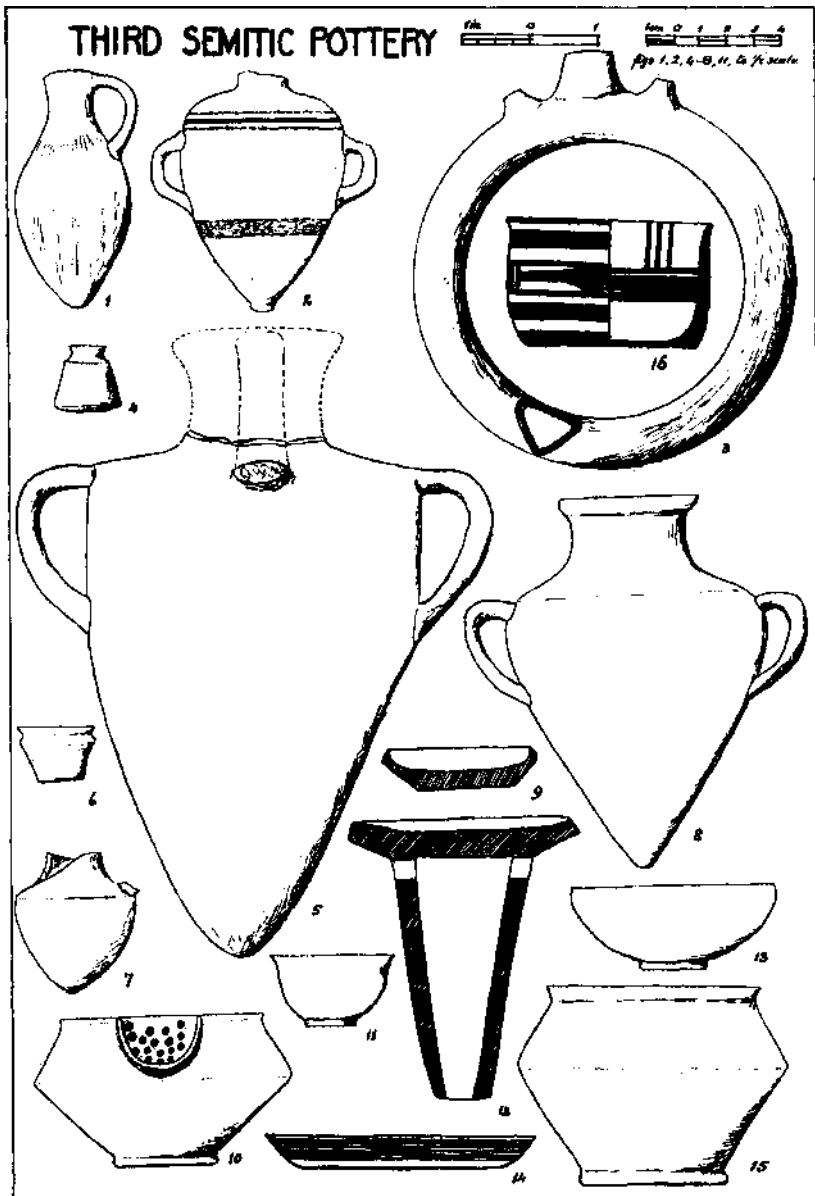





THIRD SEMITIC POTTERY

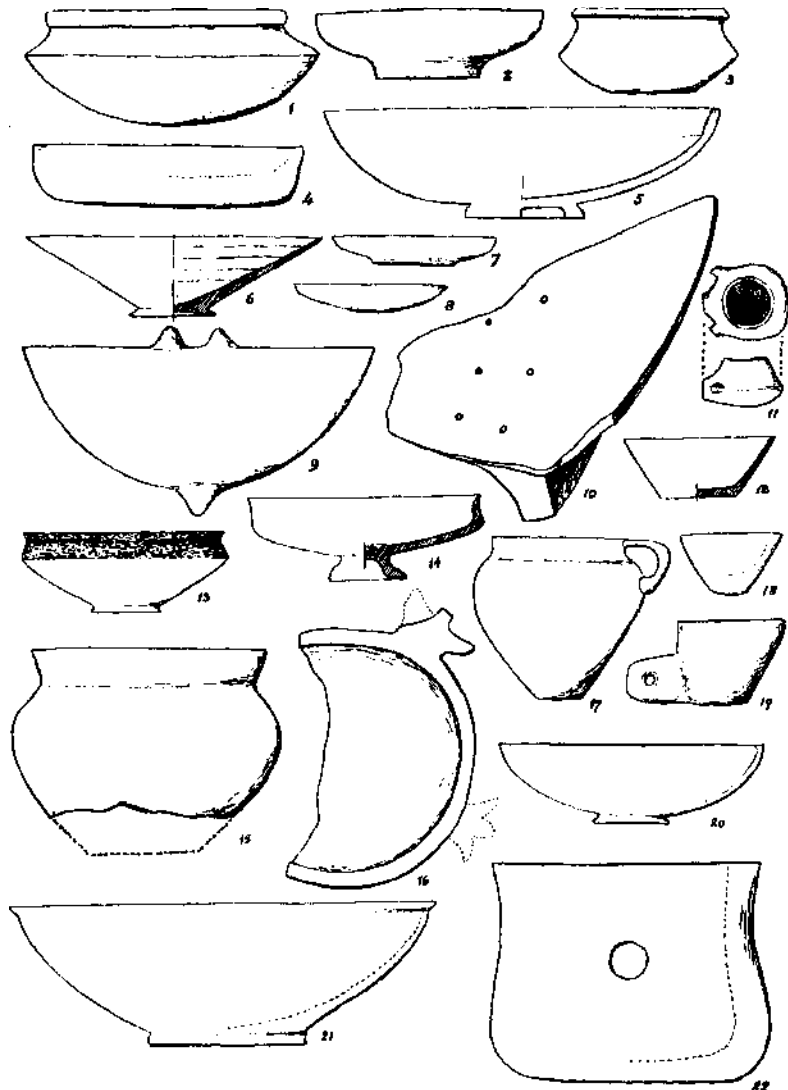

# THIRD SEMITIC POTTERY

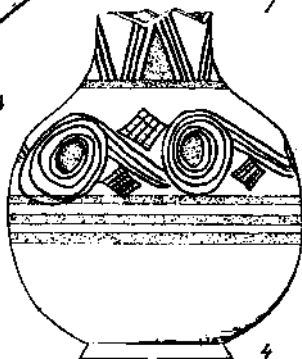
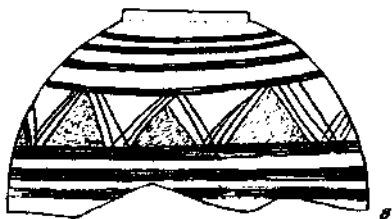
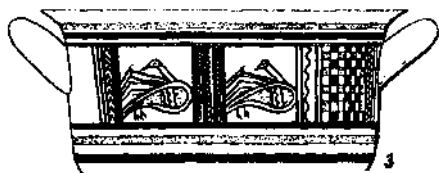
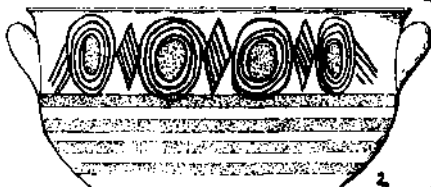





THIRD SEMITIC POTTERY

Fig. 1, 4, 6, 8, 9, 11, 12, 13, 14, 15, 16, 17, 18, 19, 20, 21, 22, 23, 24, 25, 26, 27, 28, 29, 30, 31, 32, 33, 34, 35, 36, 37, 38, 39, 40, 41, 42, 43, 44, 45, 46, 47, 48, 49, 50, 51, 52, 53, 54, 55, 56, 57, 58, 59, 60, 61, 62, 63, 64, 65, 66, 67, 68, 69, 70, 71, 72, 73, 74, 75, 76, 77, 78, 79, 80, 81, 82, 83, 84, 85, 86, 87, 88, 89, 90, 91, 92, 93, 94, 95, 96, 97, 98, 99, 100

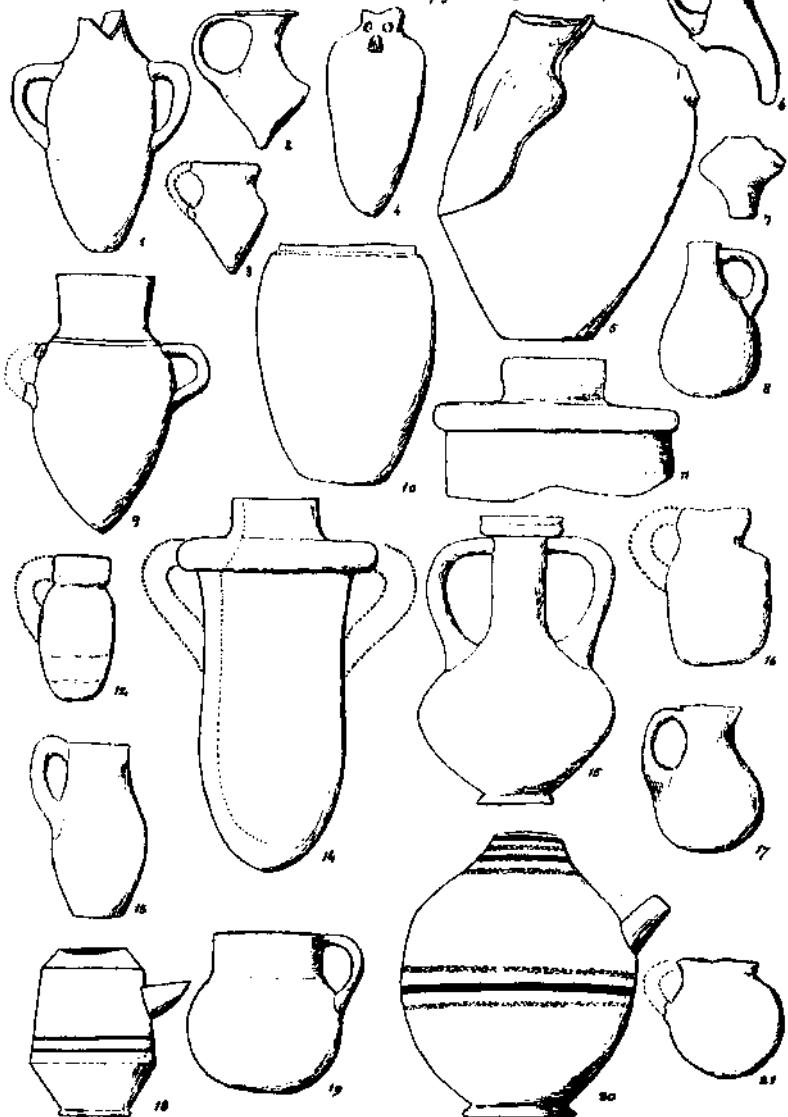

THIRD SEMITIC  
POTTERY

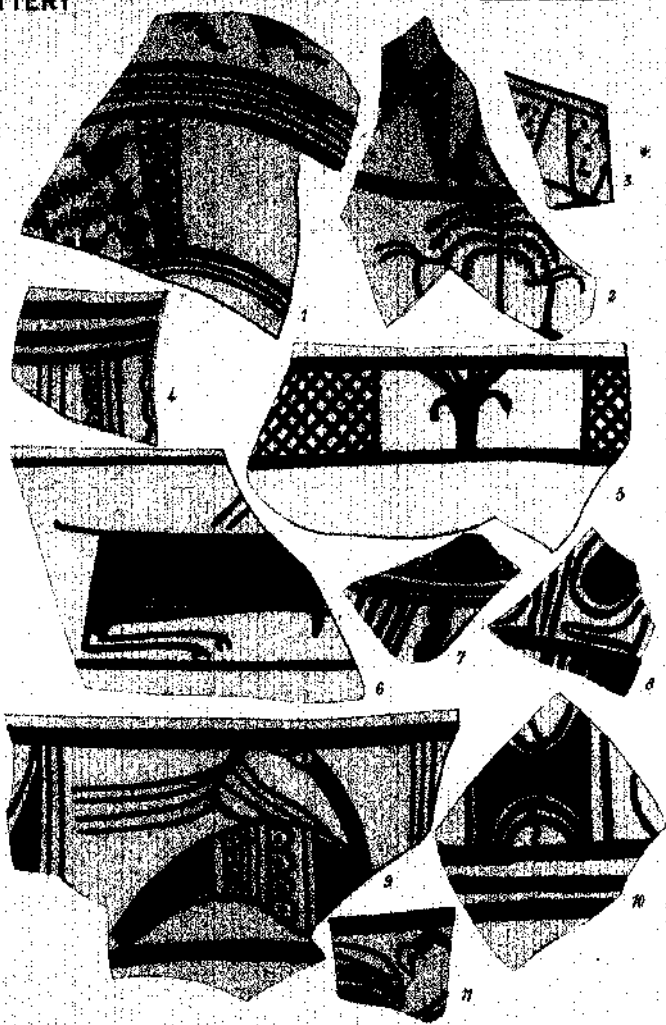
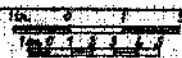



THIRD SEMITIC POTTERY

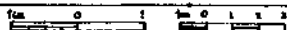
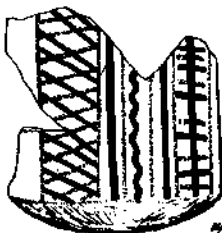
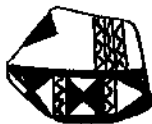
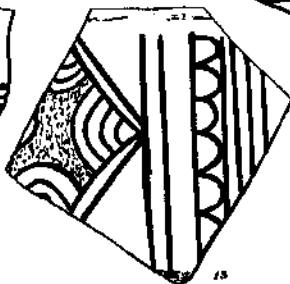
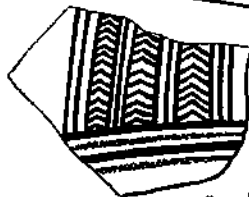
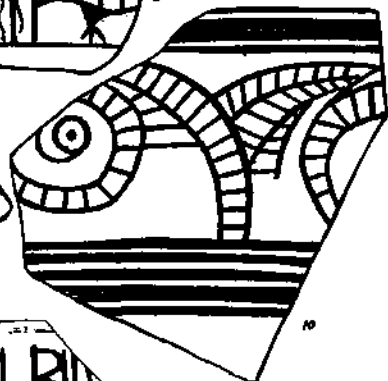
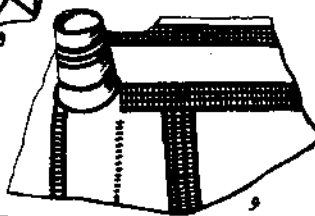
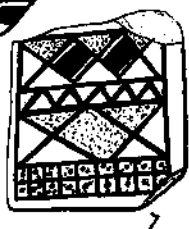
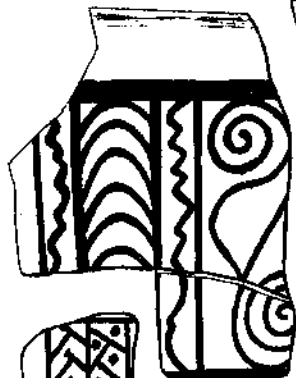
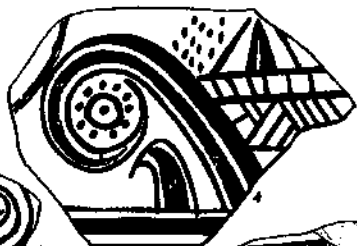

Fig. 46. 15. 7c. scale







THIRD SEMITIC POTTERY



Fig. 10 is  $\frac{1}{2}$  scale, 11 to 16,  $\frac{1}{4}$  scale



THIRD SEMITIC POTTERY

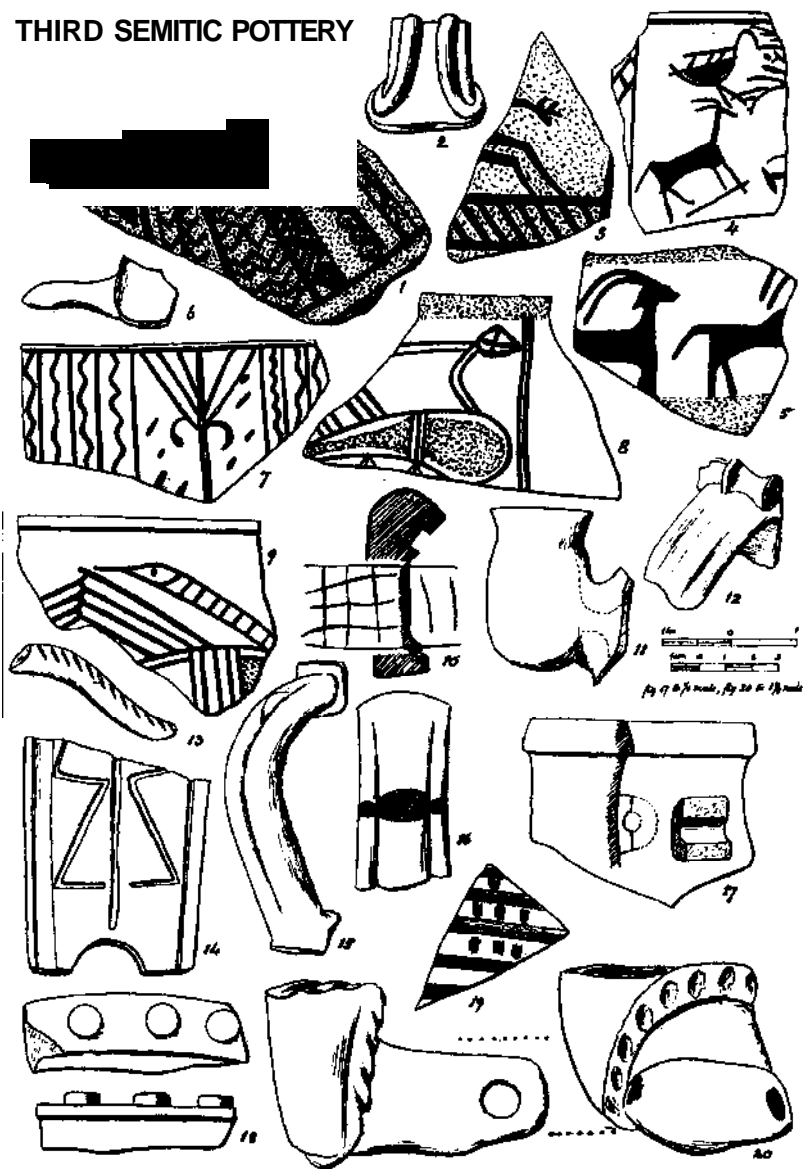





FOURTH SEMITIC POTTERY



Alge 2, 4, 9, 10, 11, 12, 13, 14, 15, 16, 17, 18, 19, 20, 21, 22, 23, 24, 25, 26, 27, 28, 29, 30, 31, 32, 33, 34, 35, 36, 37, 38, 39, 40, 41, 42, 43, 44, 45, 46, 47, 48, 49, 50, 51, 52, 53, 54, 55, 56, 57, 58, 59, 60, 61, 62, 63, 64, 65, 66, 67, 68, 69, 70, 71, 72, 73, 74, 75, 76, 77, 78, 79, 80, 81, 82, 83, 84, 85, 86, 87, 88, 89, 90, 91, 92, 93, 94, 95, 96, 97, 98, 99, 100



FOURTH SEMITIC POTTERY

1 dm 0 1 2 3 4 5  
2 dm 0 1 2 3 4 5  
Fig. 2, 9, 10, 12, 13, 14 made







FOURTH SEMITIC POTTERY

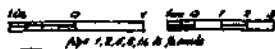

## FOURTH SEMITIC POTTERY

Figs. 1-6-7, 21, 22, 24, 25, 26, 27, 28, 29, 30, 31, 32, 33, 34, 35, 36, 37, 38, 39, 40, 41, 42, 43, 44, 45, 46, 47, 48, 49, 50, 51, 52, 53, 54, 55, 56, 57, 58, 59, 60, 61, 62, 63, 64, 65, 66, 67, 68, 69, 70, 71, 72, 73, 74, 75, 76, 77, 78, 79, 80, 81, 82, 83, 84, 85, 86, 87, 88, 89, 90, 91, 92, 93, 94, 95, 96, 97, 98, 99, 100







FOURTH SEMITIC POTTERY



Age 4, 6 & 8, 10, 12



## FOURTH SEMITIC POTTERY



figs 6, 10, 12, 13, 15, 16, 18 double scale: figs 8 & 14

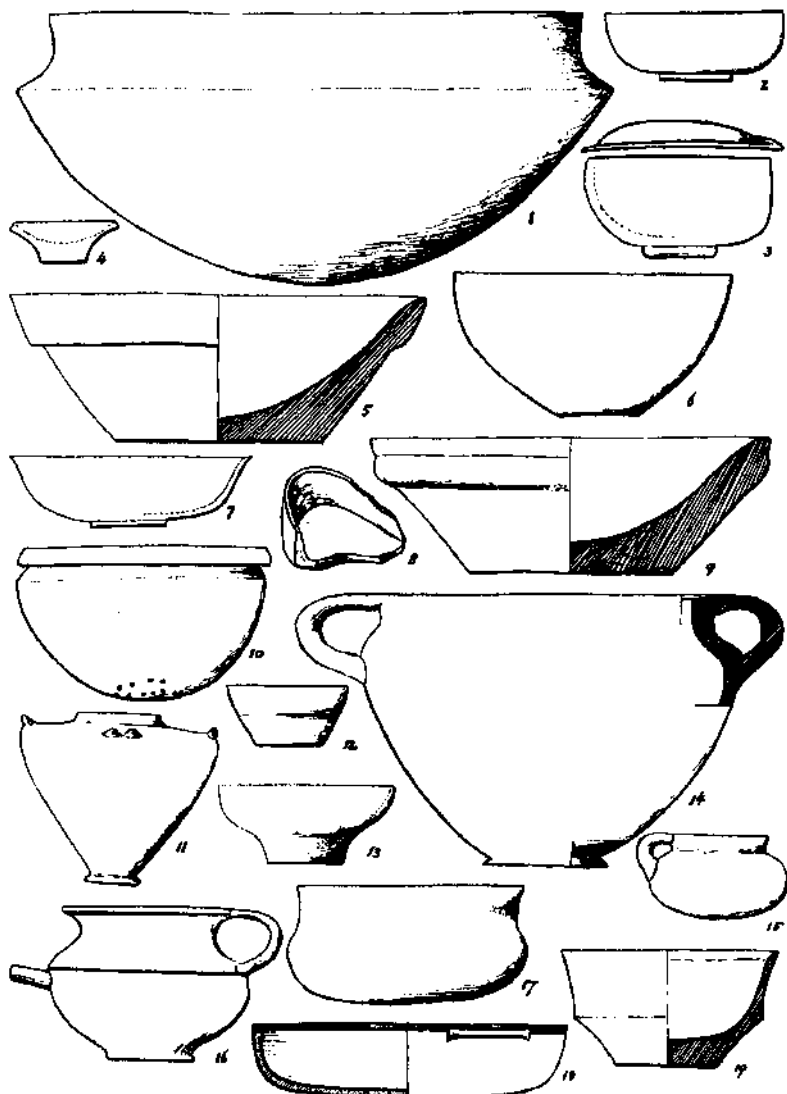





FOURTH SEMITIC POTTERY

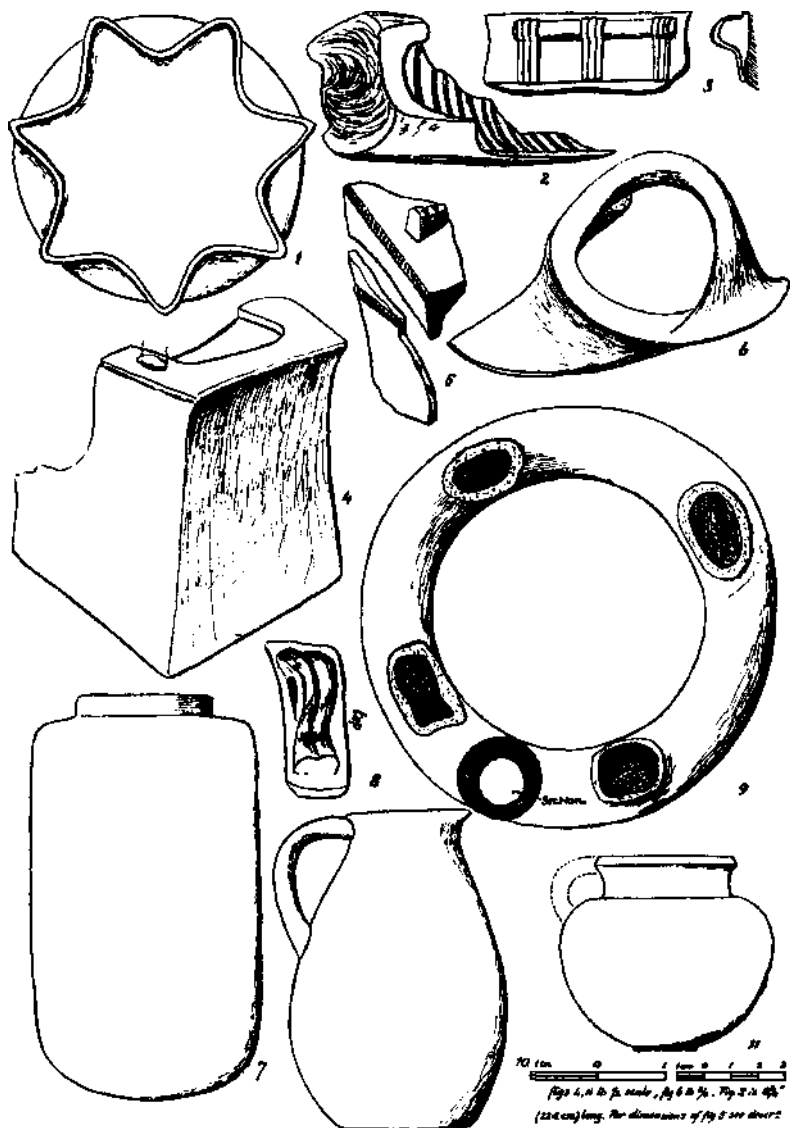

# FOURTH SEMITIC POTTERY

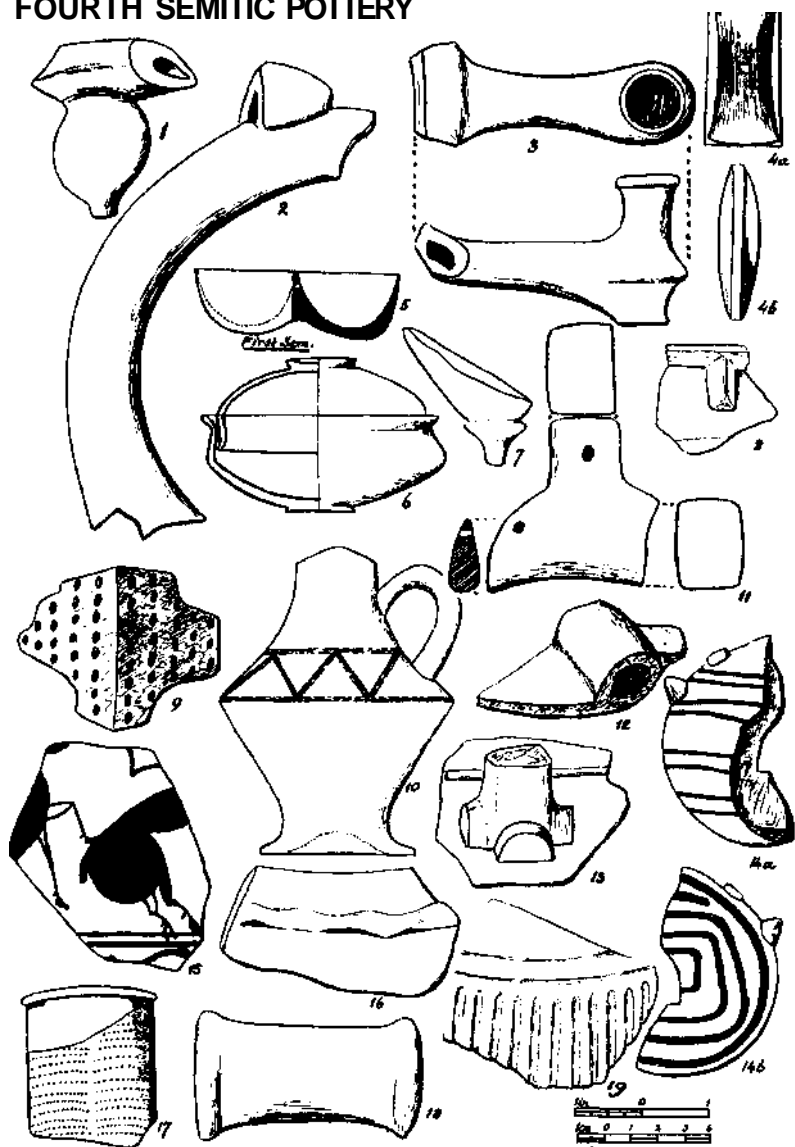





CREEK POTSDHERDS



## HELLENISTIC POTTERY

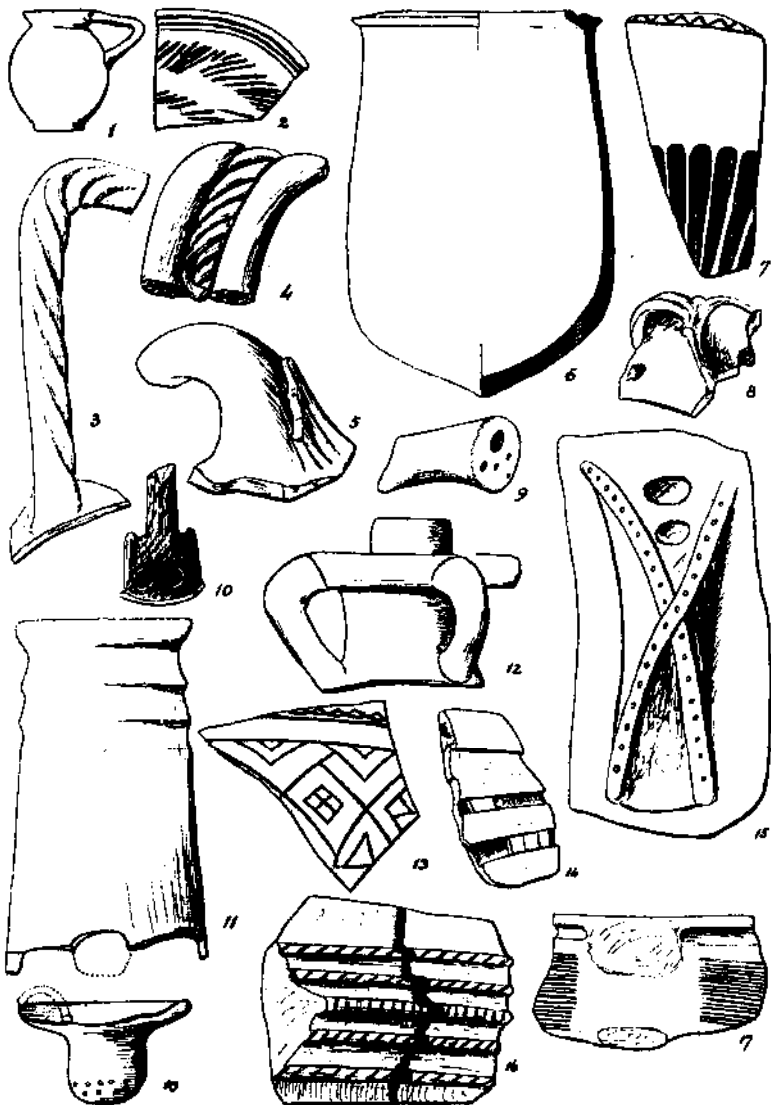
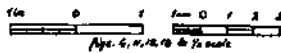





HELLENISTIC POTTERY

1	2	3	4
5	6	7	8

Fig. 10, 11, 12, 13, 14, 15, 16, 17, 18, 19, 20, 21, 22, 23, 24, 25, 26, 27, 28, 29, 30

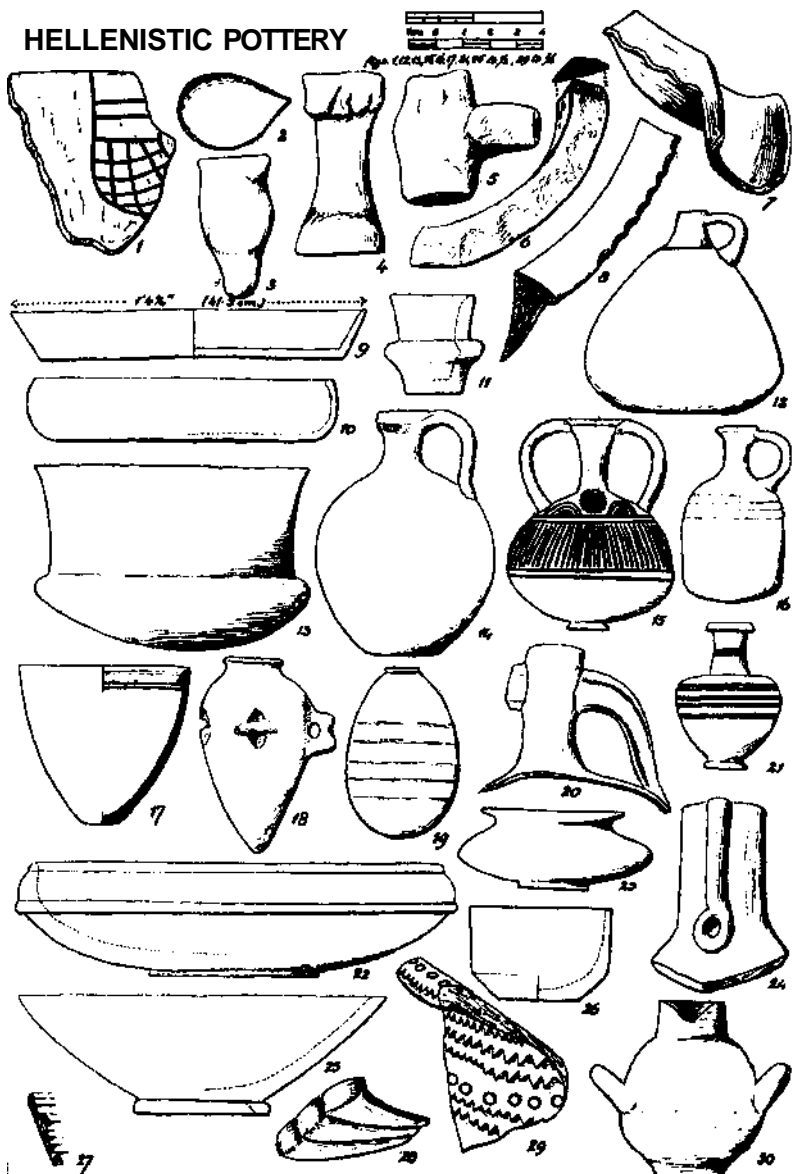

HELLENISTIC POTTERY

cm 1 2 3 4 5

cm 1 2

*Figs. 1, 2, 6 & 12 half scale*

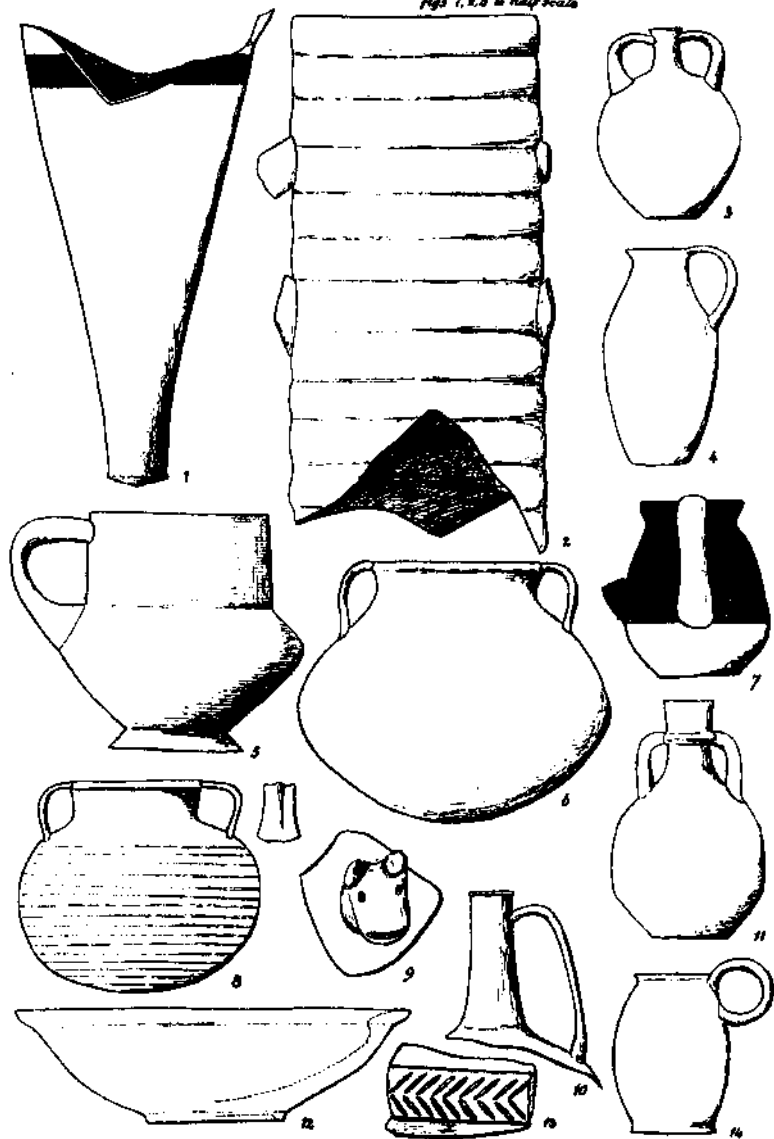





HELLENISTIC POTTERY

Mod. g.	Class.	1	2	3	4	5
1	Class.	1	2	3	4	5

Mod. g.	1	2	3	4
1	1	2	3	4

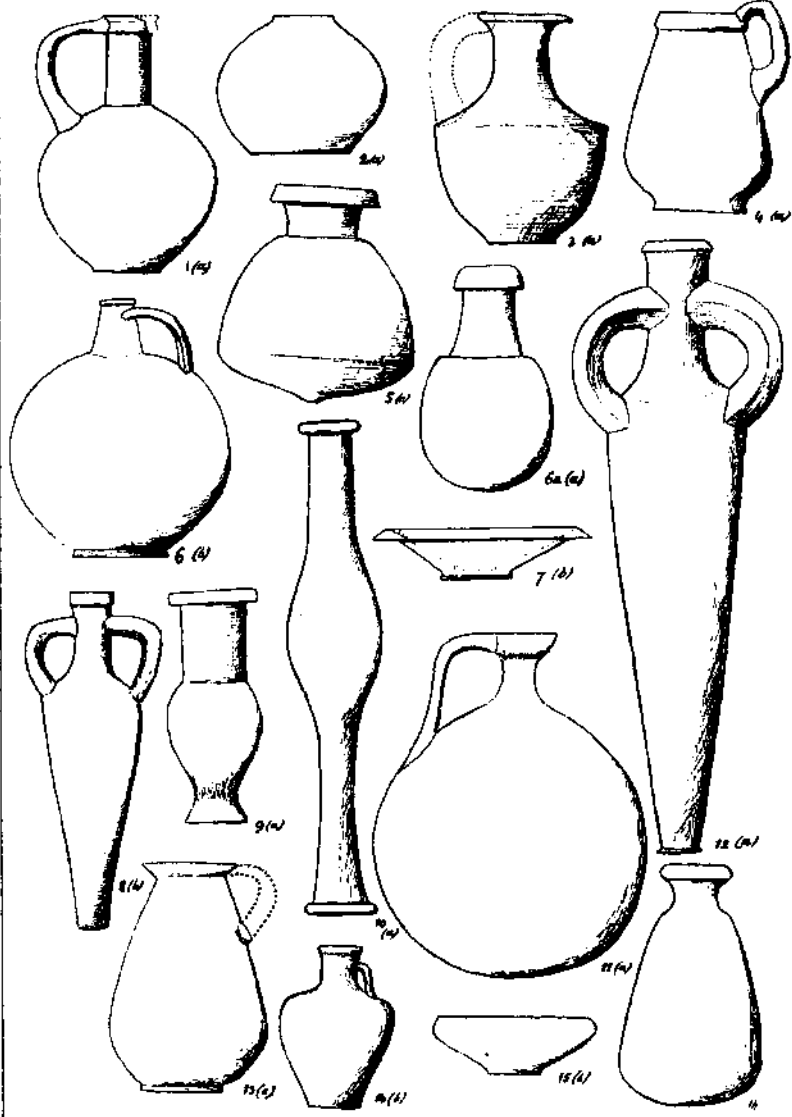

HELLENISTIC POTTERY

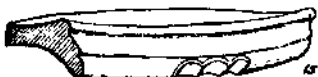
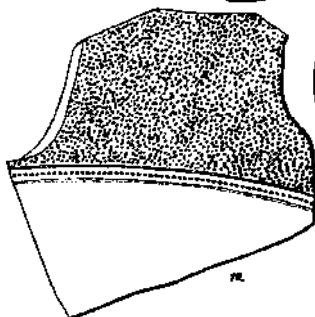
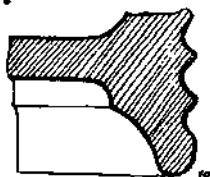
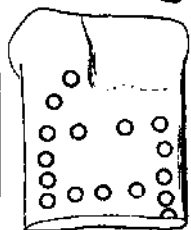
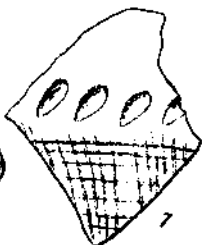
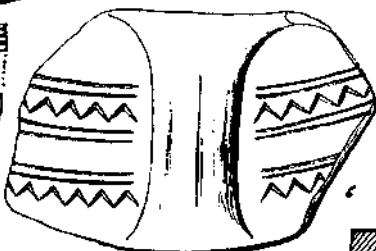
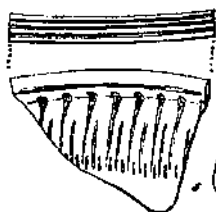
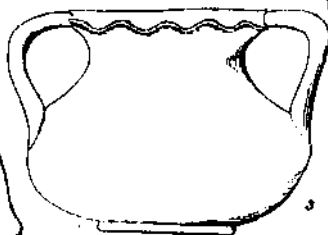
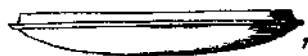
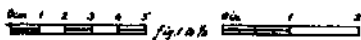





HELLENISTIC POTTERY

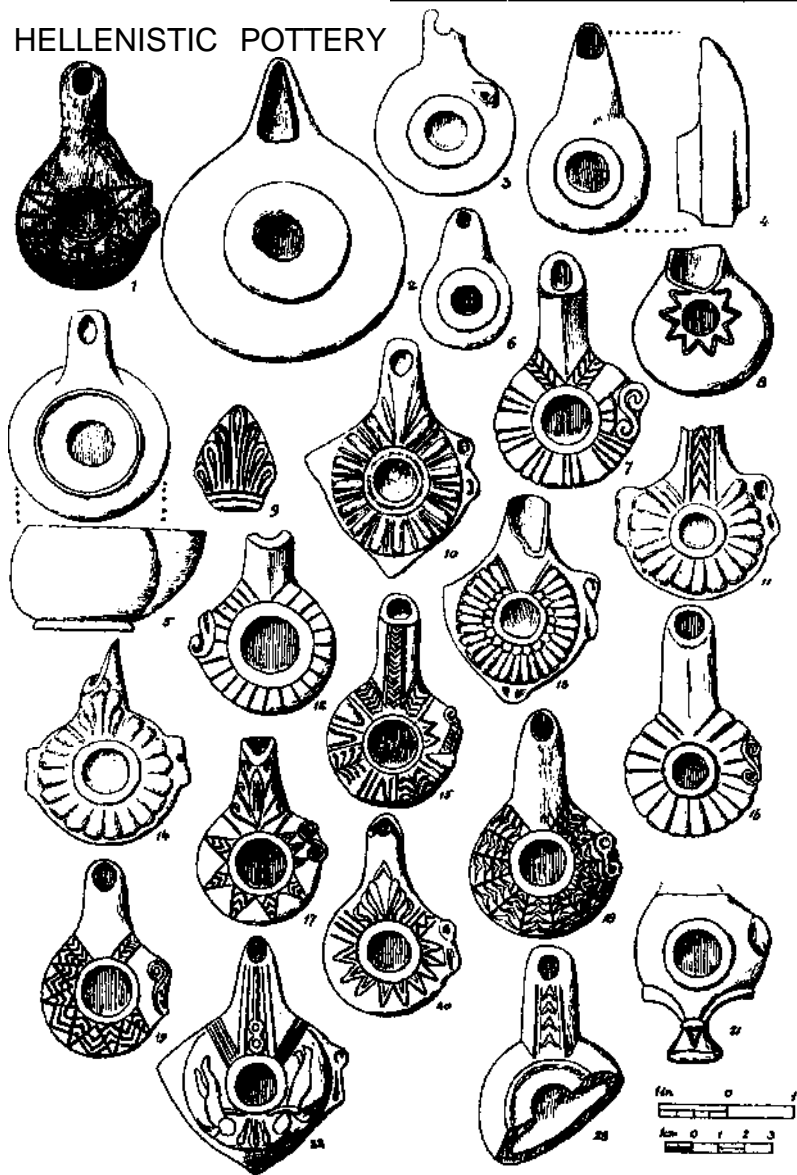

HELLENISTIC POTTERY

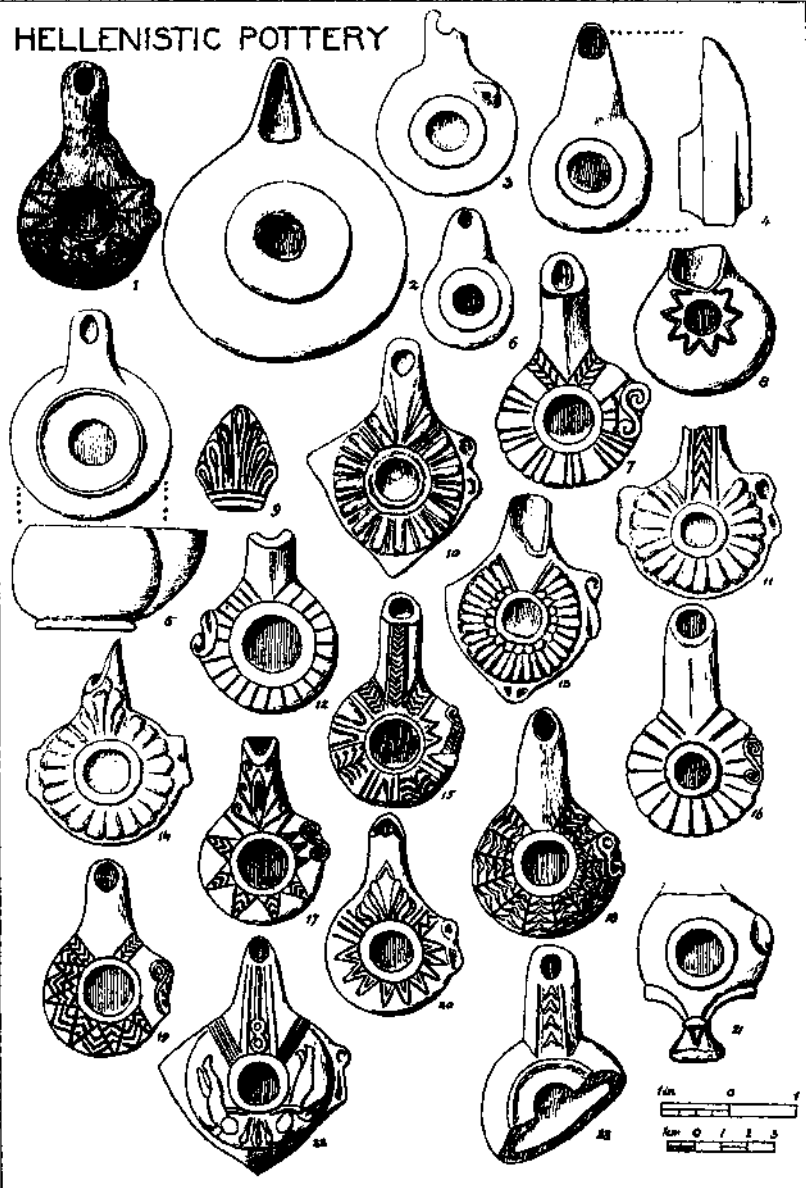

HELLENISTIC POTTERY

Figs 4, 8, 9, 10 to double scale.  
 Diam. 1 2 3 4  
 5 6 7 8 9 10

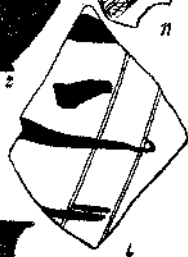
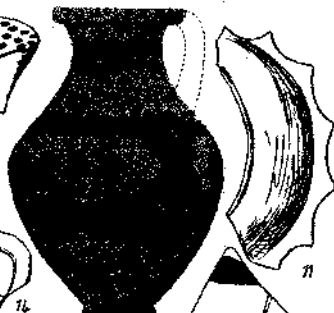

section of handle  
 Fig. 7.

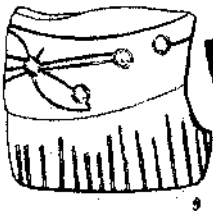



CONTENTS OF CISTERN IN IV II

*Fig. 10-16 double size*  
 1 2 3 4 5 6 7 8 9 10 11 12 13 14 15 16

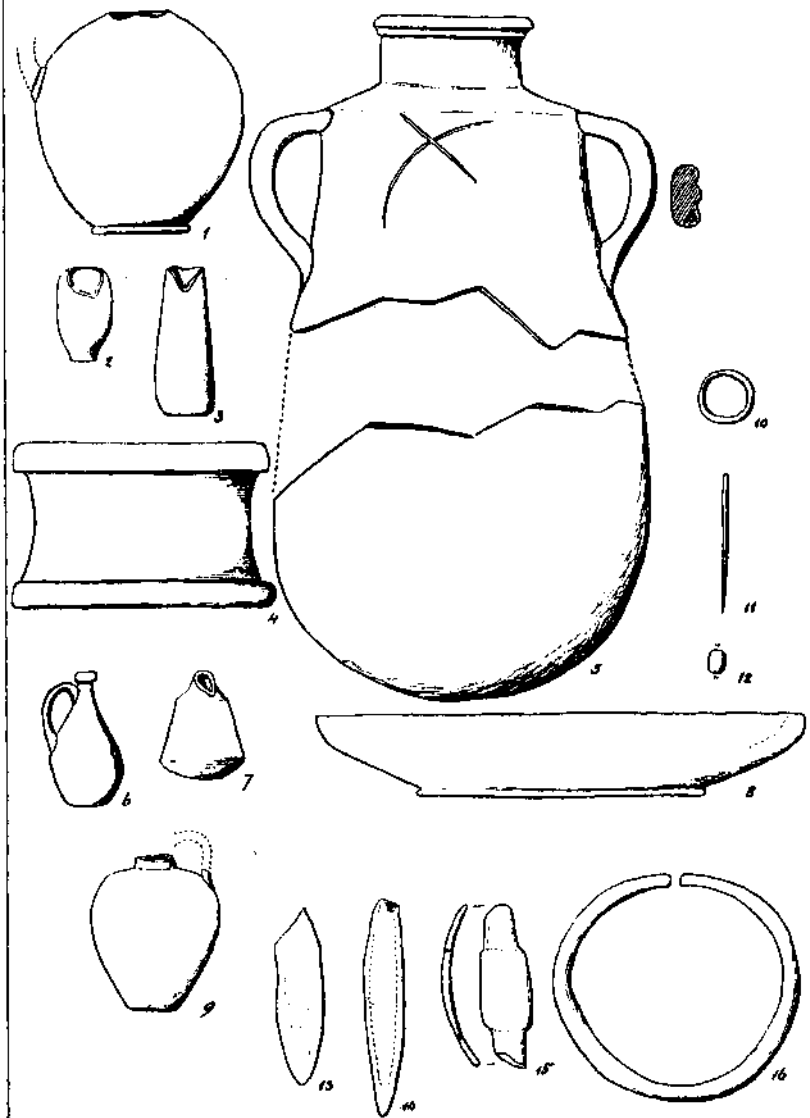

CONTENTS OF CISTERN IN IV 11

*Figs. 479 to double scale*  

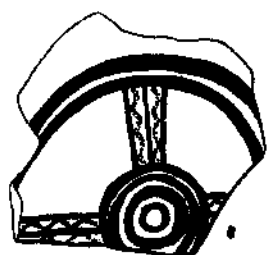
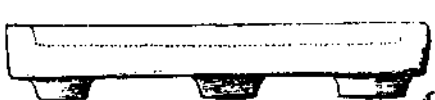
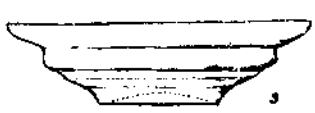
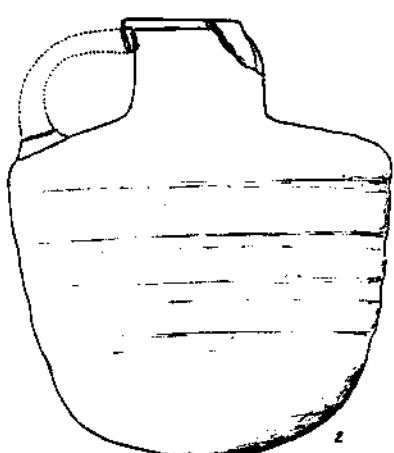
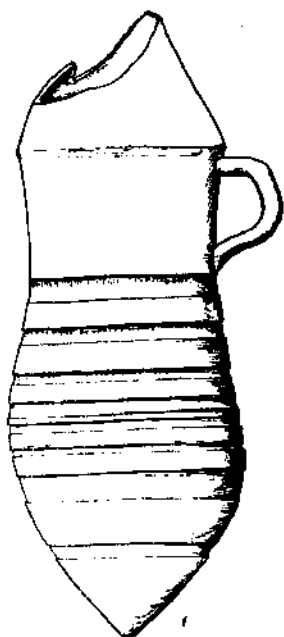

CONTENTS OF CISTERN IN IV 11

*Figs. 17, 18, 20, 22, 24, 25 to double scale.*

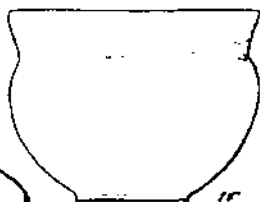
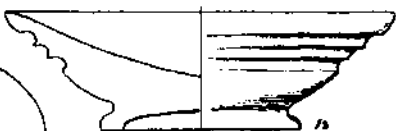
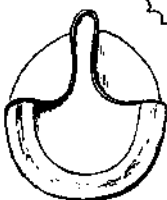
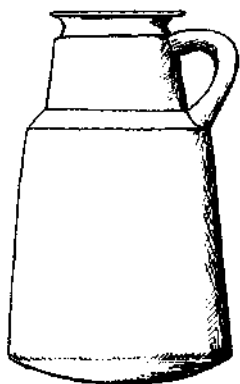
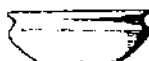
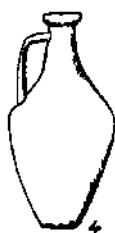

THE "CANDLESTICK" LAMP  
AND ITS VARIETIES

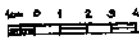
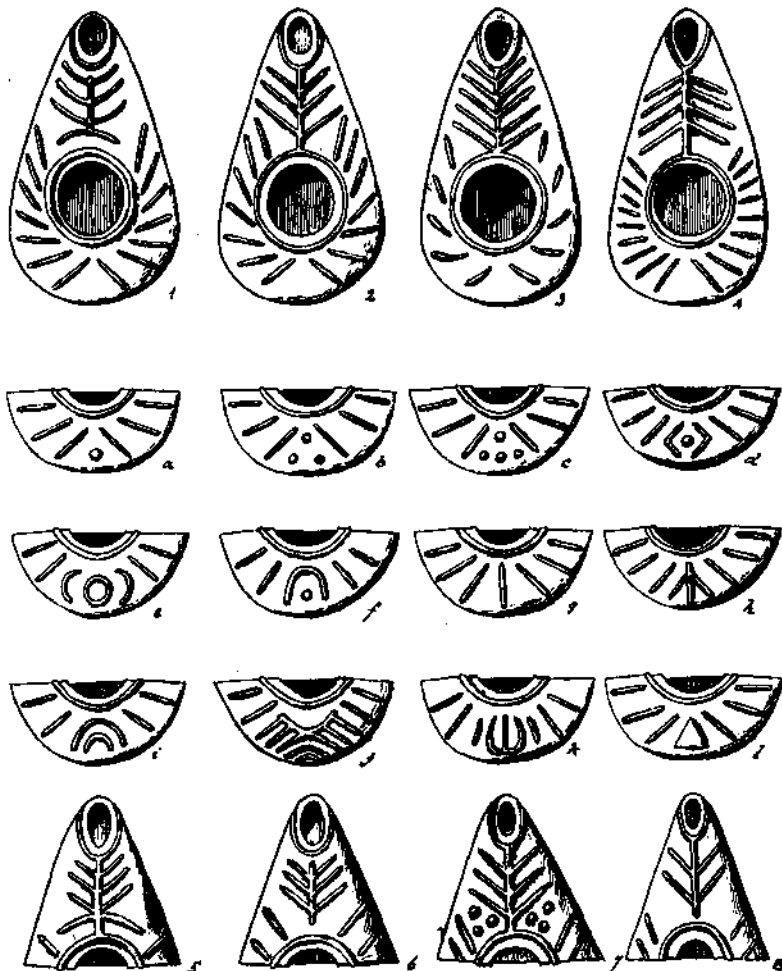

ARAB POTTERY &c.



Figs. 26-36 to double scale







POTTERS' MARKS

First Semitic

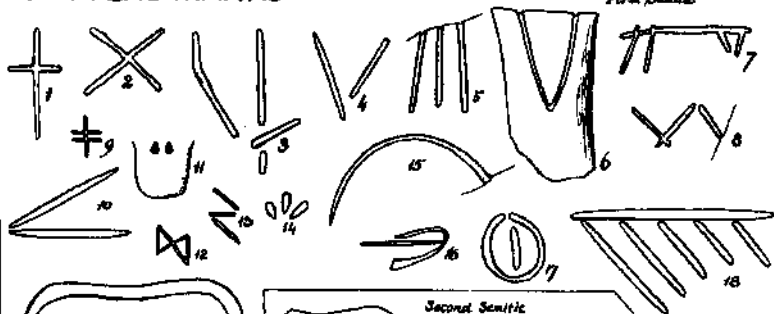

Second Semitic

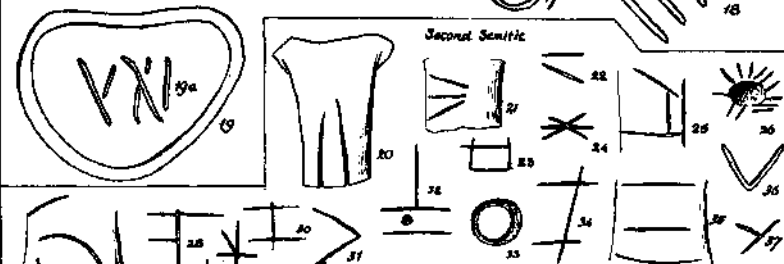

Third Semitic

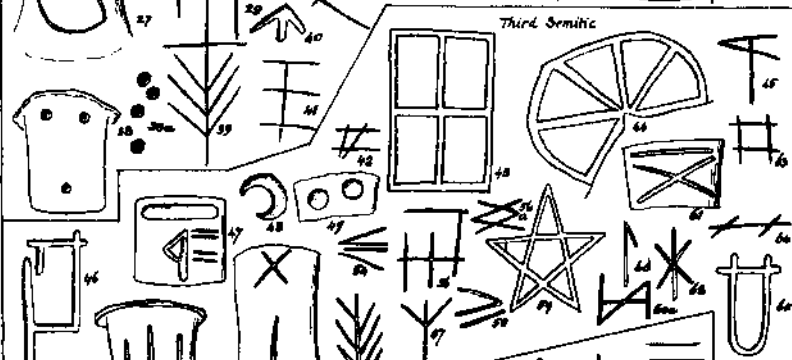

4<sup>th</sup> Semitic

JAR-STOPPERS

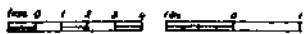
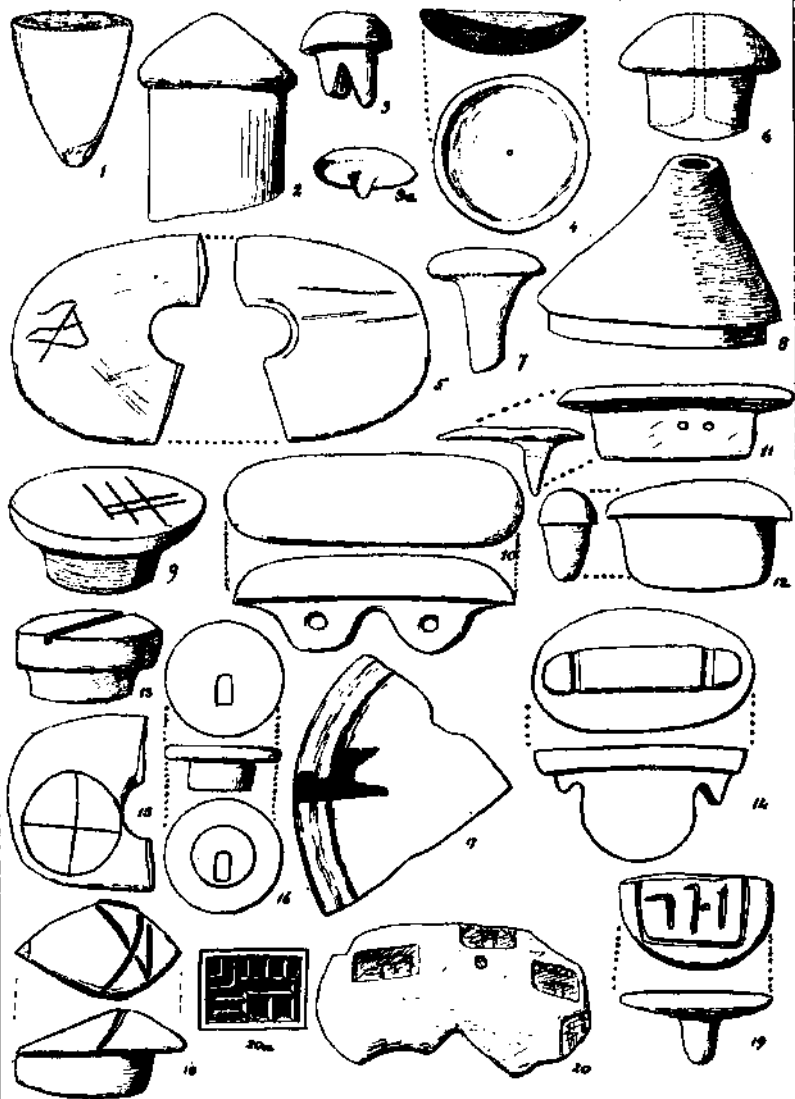

Fig. 1 to Amph. sexta







# BRONZE AXE-HEADS

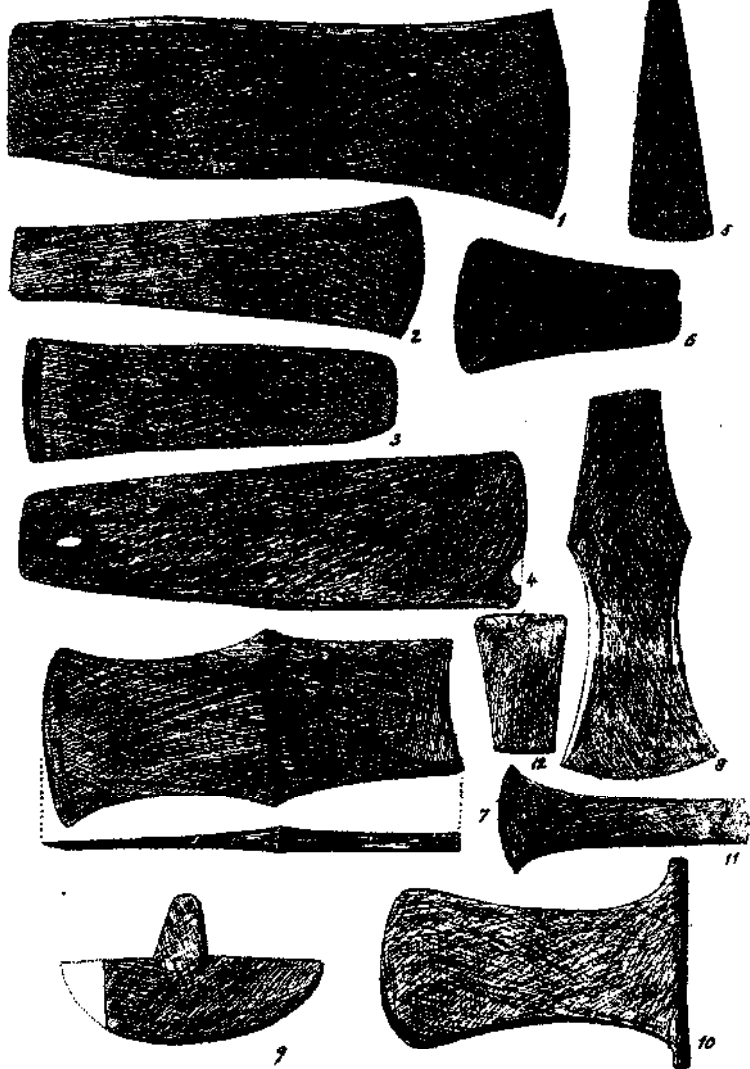
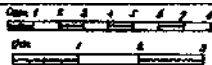

# CARPENTERS' TOOLS

Fig. 2, 11, 6, 10, 12, 13, 14, 15, 16, 17, 18, 19, 20, 21, 22, 23, 24, 25, 26, 27, 28, 29, 30, 31, 32, 33, 34, 35, 36, 37, 38, 39, 40, 41, 42, 43, 44, 45, 46, 47, 48, 49, 50, 51, 52, 53, 54, 55, 56, 57, 58, 59, 60, 61, 62, 63, 64, 65, 66, 67, 68, 69, 70, 71, 72, 73, 74, 75, 76, 77, 78, 79, 80, 81, 82, 83, 84, 85, 86, 87, 88, 89, 90, 91, 92, 93, 94, 95, 96, 97, 98, 99, 100

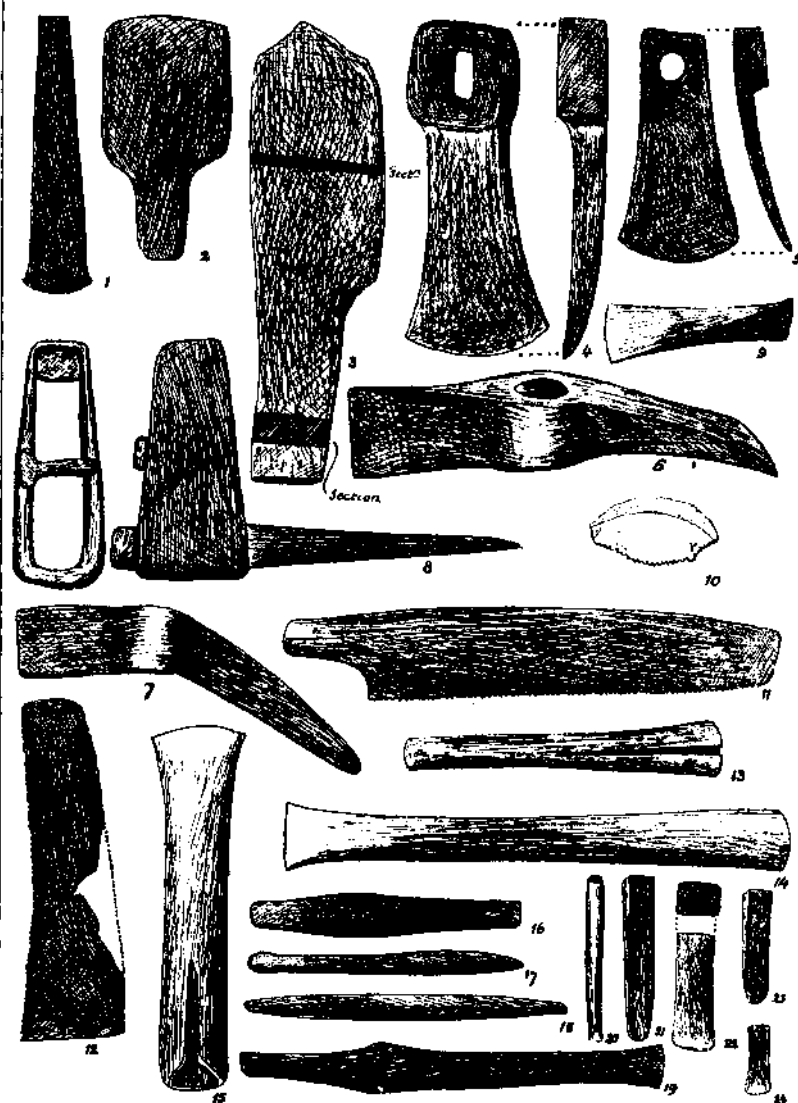





CARPENTERS' TOOLS

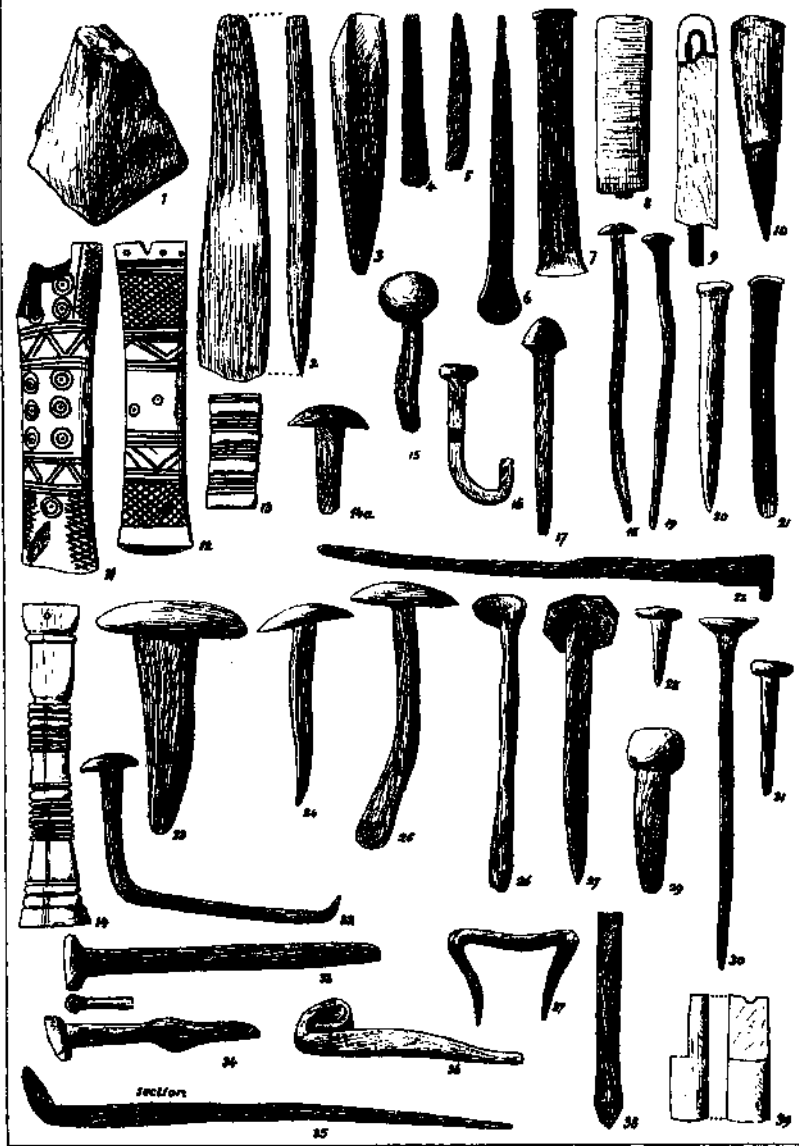

section

35

## INLAYS

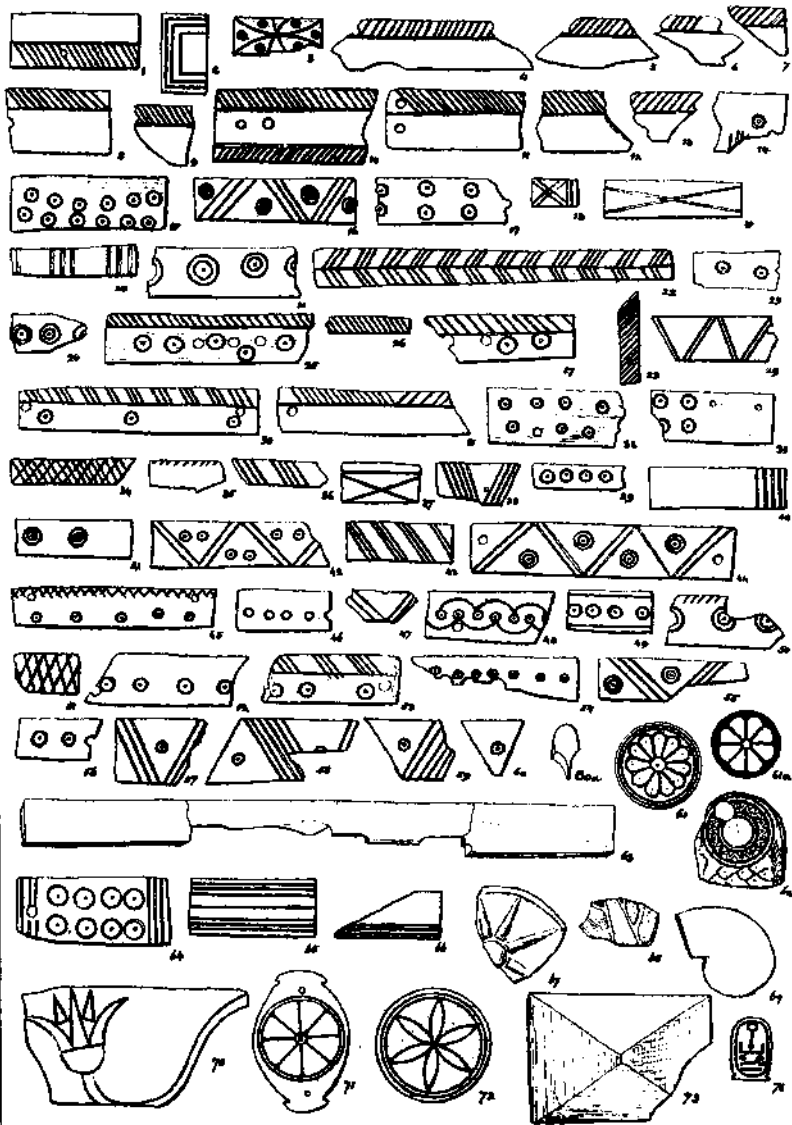
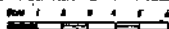





STONE MISCELLANEA



*figs. 2, 5, 4, 18, 19 to half scale*

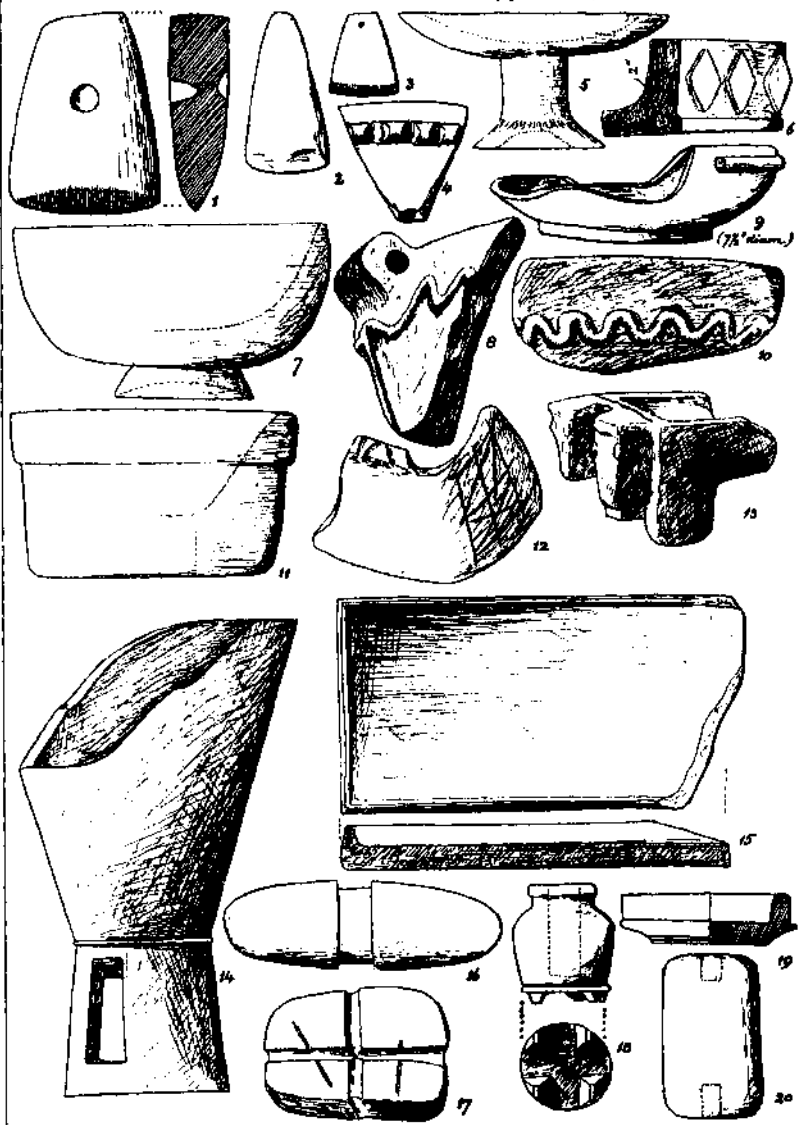

METAL MISCELLANEA (1-27 BRONZE 28-41 IRON)

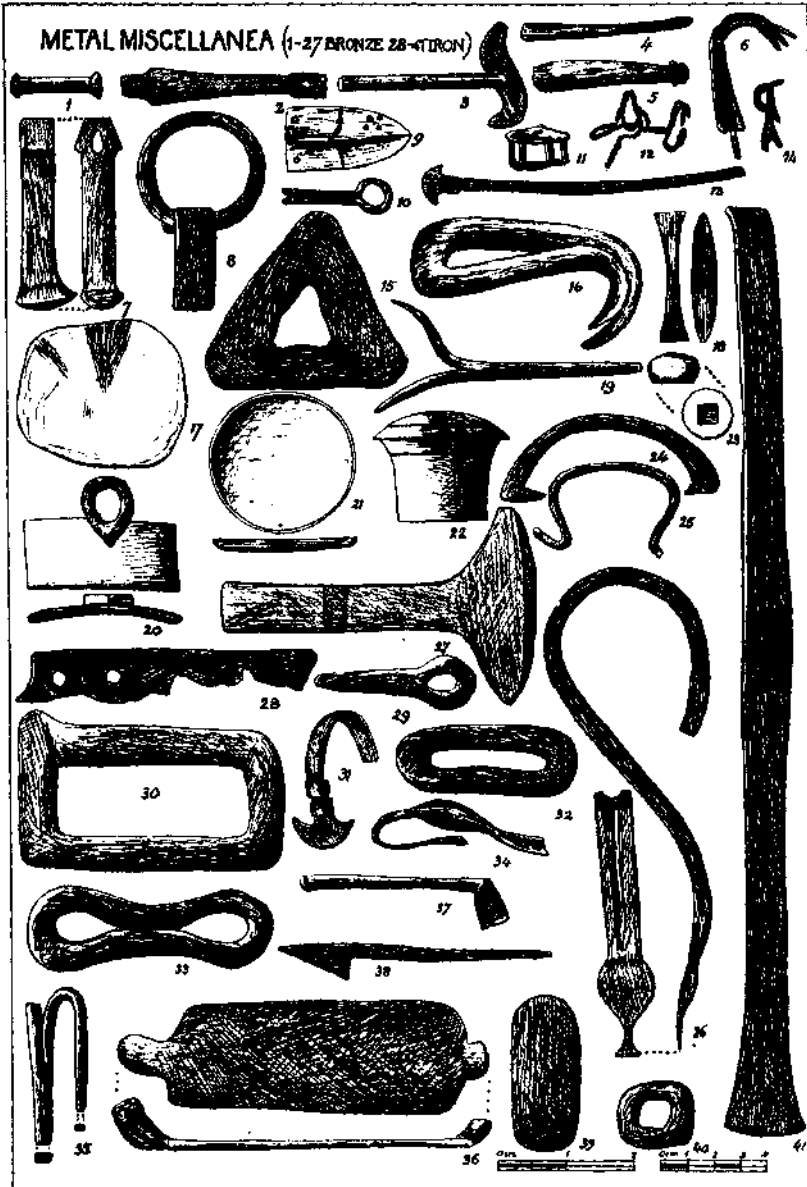





KNIVES (BRONZE)

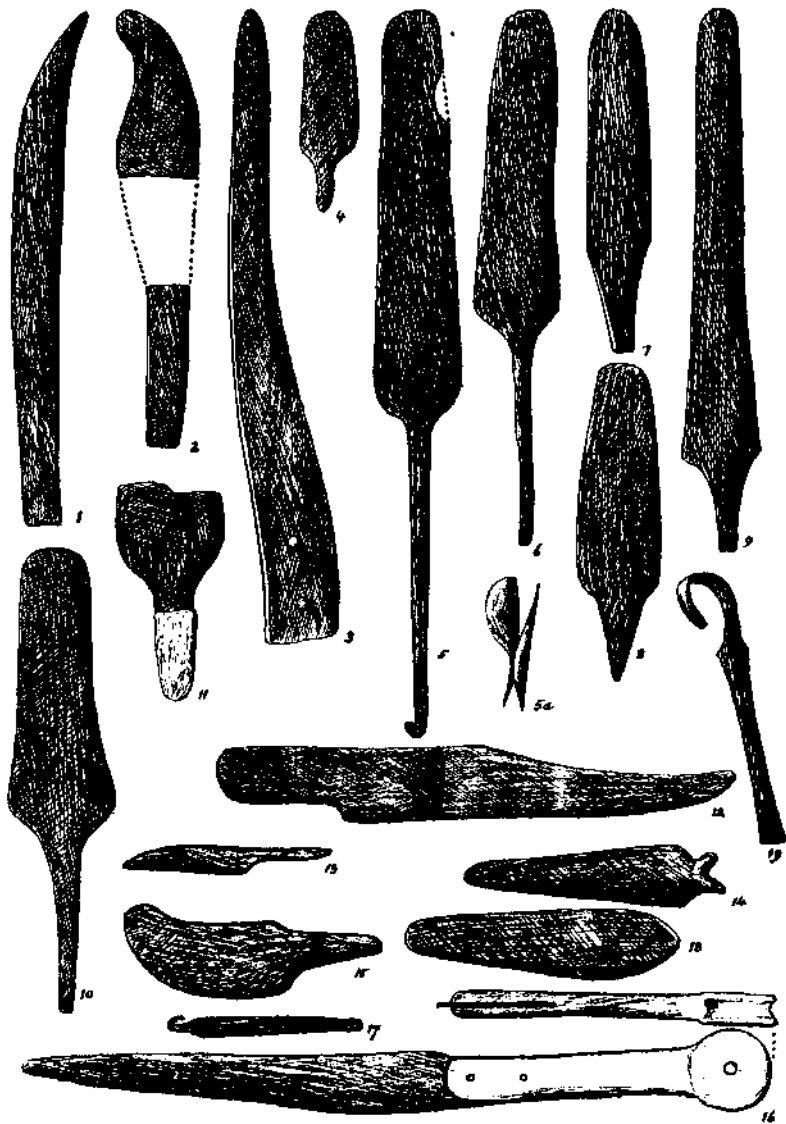

KNIVES (IRON)

Fig 7 & half scale  
0 1 2 3 4 5 6 7 8 9 10

0 1 2 3 4 5 6 7 8 9 10

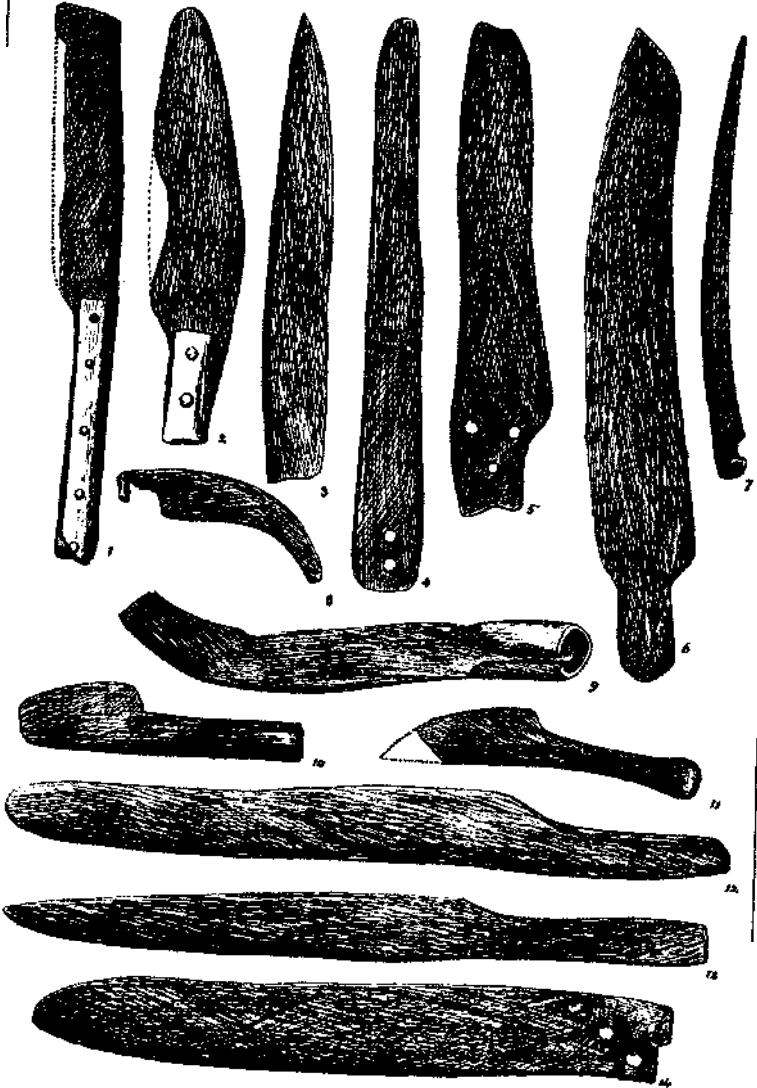





SEALS

Figs. 33-36, 38-40, 42-44, 46-48, 50-52, 54-56, 58-60, 62-64, 66-68, 70-72, 74-76, 78-80, 82-84, 86-88, 90-92, 94-96, 98-100, 102-104, 106-108, 110-112, 114-116, 118-120, 122-124, 126-128, 130-132, 134-136, 138-140, 142-144, 146-148, 150-152, 154-156, 158-160, 162-164, 166-168, 170-172, 174-176, 178-180, 182-184, 186-188, 190-192, 194-196, 198-200, 202-204, 206-208, 210-212, 214-216, 218-220, 222-224, 226-228, 230-232, 234-236, 238-240, 242-244, 246-248, 250-252, 254-256, 258-260, 262-264, 266-268, 270-272, 274-276, 278-280, 282-284, 286-288, 290-292, 294-296, 298-300, 302-304, 306-308, 310-312, 314-316, 318-320, 322-324, 326-328, 330-332, 334-336, 338-340, 342-344, 346-348, 350-352, 354-356, 358-360, 362-364, 366-368, 370-372, 374-376, 378-380, 382-384, 386-388, 390-392, 394-396, 398-400, 402-404, 406-408, 410-412, 414-416, 418-420, 422-424, 426-428, 430-432, 434-436, 438-440, 442-444, 446-448, 450-452, 454-456, 458-460, 462-464, 466-468, 470-472, 474-476, 478-480, 482-484, 486-488, 490-492, 494-496, 498-500, 502-504, 506-508, 510-512, 514-516, 518-520, 522-524, 526-528, 530-532, 534-536, 538-540, 542-544, 546-548, 550-552, 554-556, 558-560, 562-564, 566-568, 570-572, 574-576, 578-580, 582-584, 586-588, 590-592, 594-596, 598-600, 602-604, 606-608, 610-612, 614-616, 618-620, 622-624, 626-628, 630-632, 634-636, 638-640, 642-644, 646-648, 650-652, 654-656, 658-660, 662-664, 666-668, 670-672, 674-676, 678-680, 682-684, 686-688, 690-692, 694-696, 698-700, 702-704, 706-708, 710-712, 714-716, 718-720, 722-724, 726-728, 730-732, 734-736, 738-740, 742-744, 746-748, 750-752, 754-756, 758-760, 762-764, 766-768, 770-772, 774-776, 778-780, 782-784, 786-788, 790-792, 794-796, 798-800, 802-804, 806-808, 810-812, 814-816, 818-820, 822-824, 826-828, 830-832, 834-836, 838-840, 842-844, 846-848, 850-852, 854-856, 858-860, 862-864, 866-868, 870-872, 874-876, 878-880, 882-884, 886-888, 890-892, 894-896, 898-900, 902-904, 906-908, 910-912, 914-916, 918-920, 922-924, 926-928, 930-932, 934-936, 938-940, 942-944, 946-948, 950-952, 954-956, 958-960, 962-964, 966-968, 970-972, 974-976, 978-980, 982-984, 986-988, 990-992, 994-996, 998-1000



DRAUGHT-BOARDS

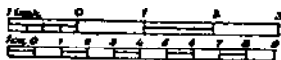

Figs 1, 4, 6, 8, 9 to half scale

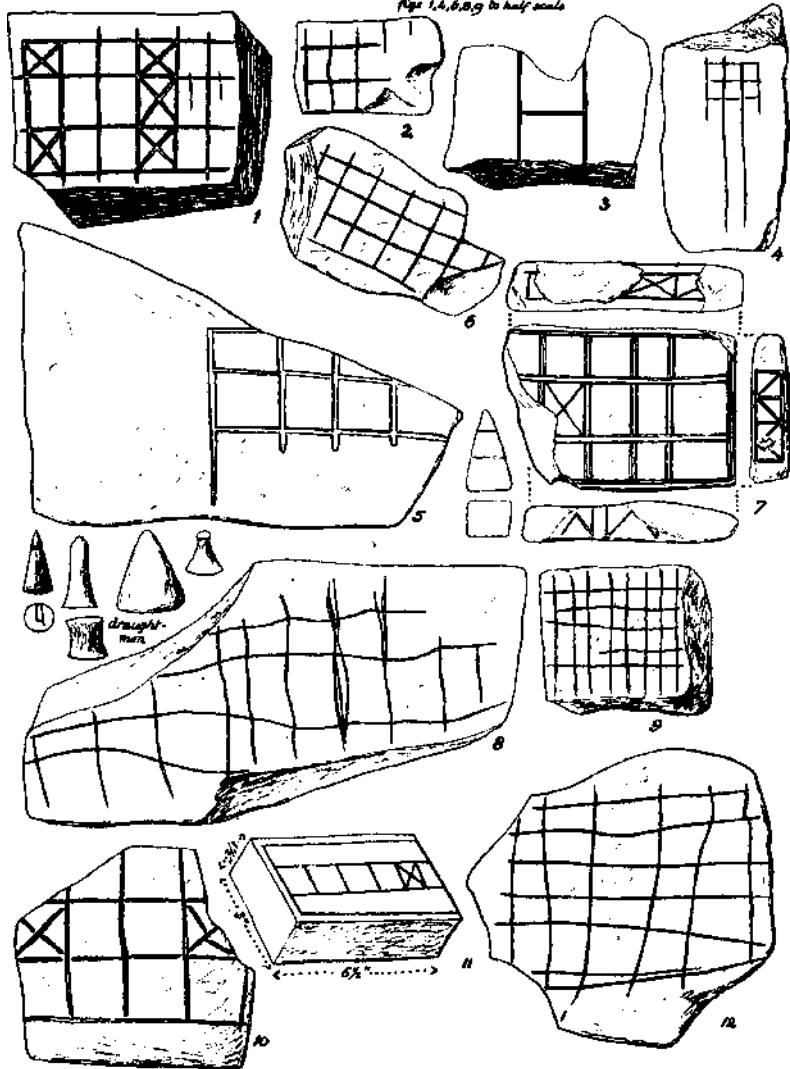





Plate ccia

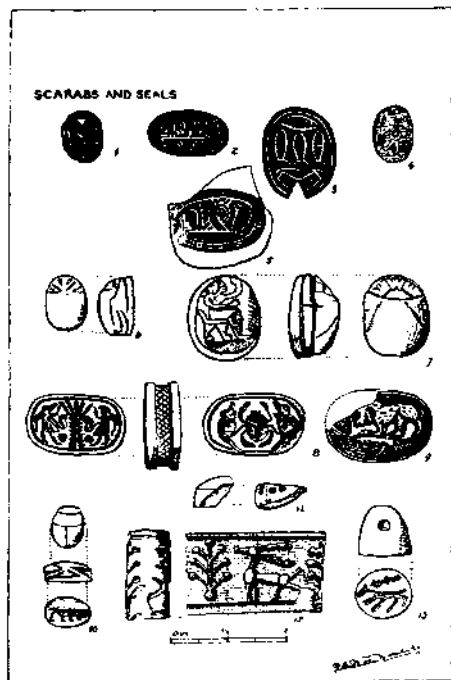

Plate ccii b

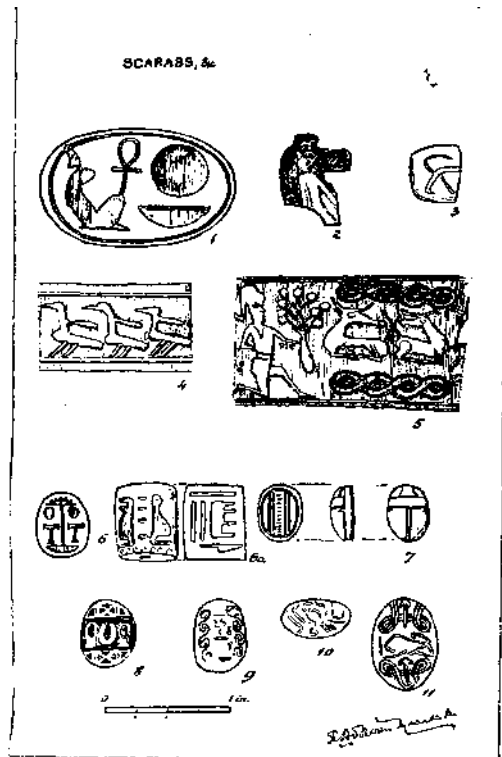

Plate cciii a



Plate cciii b

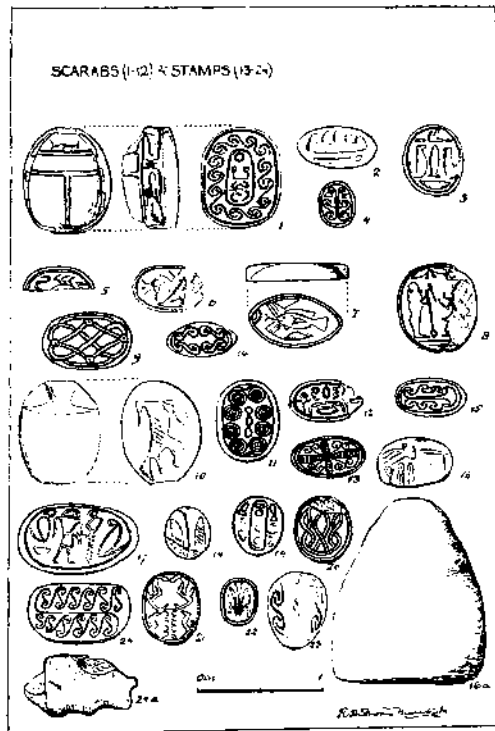





Plate cciv a

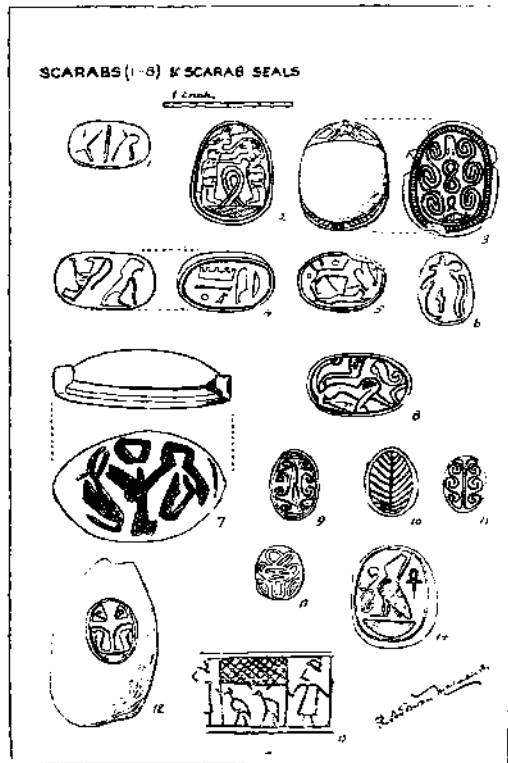

Plate cciv b

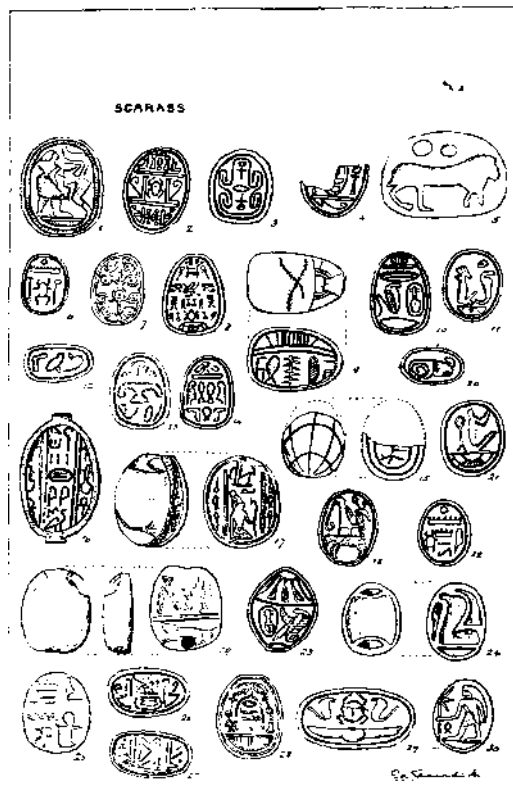

Plate ccv a

SCARABS



Plate ccv 6

PORCELAIN SAUCER

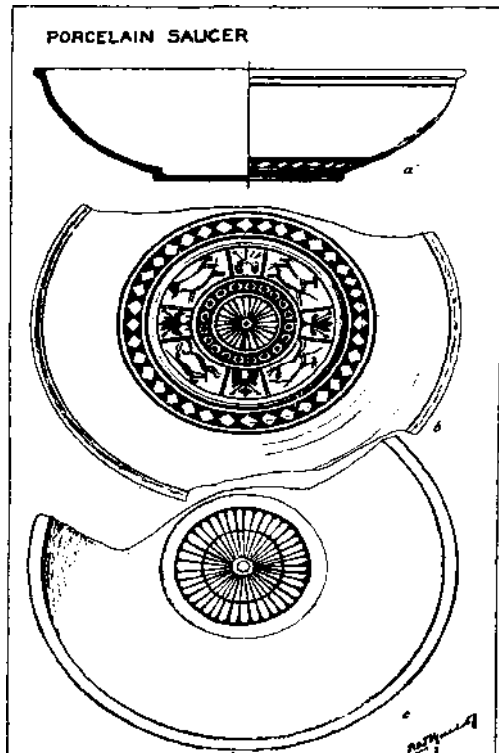





## SCARABS

1/2 inch      1/2 inch



SCARABS

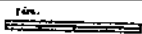

0cm. 1 2

Fig. 30. M to female







SCARABS

1 cm 1 2  
 figs 32, 34, 37, and 42, 53 to 56, 60, 61

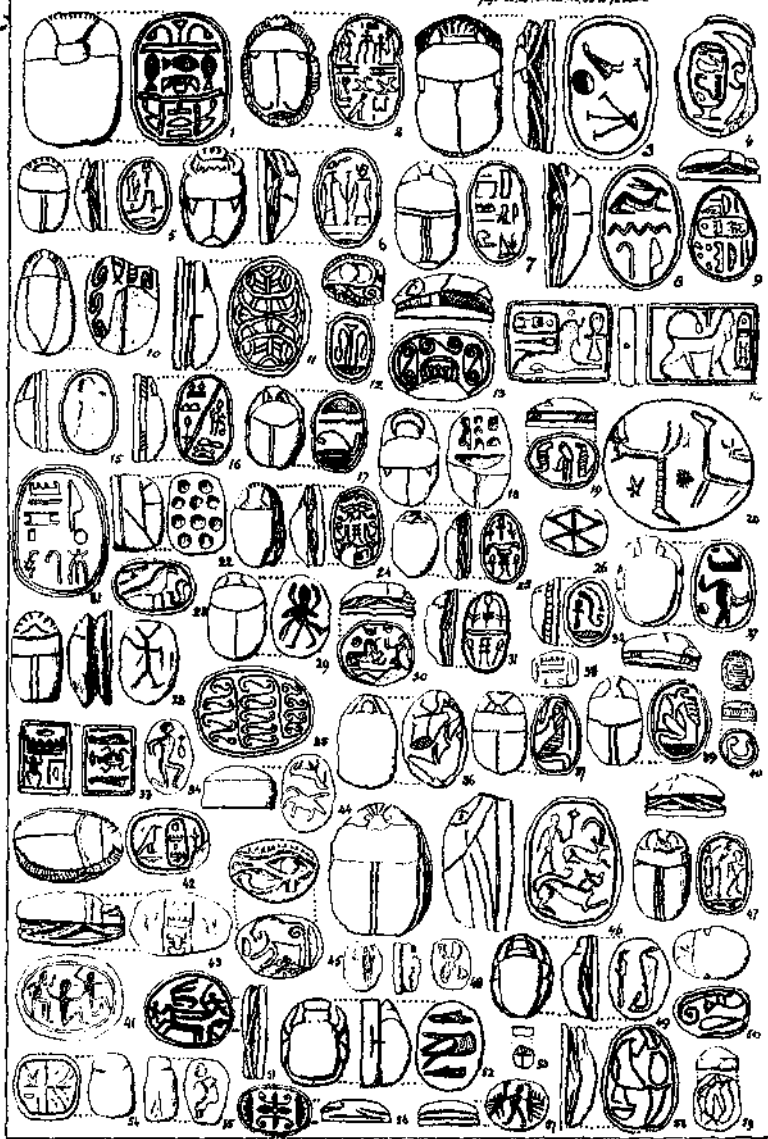

# SCARABS &c

0.5 1 2      1 2 3 4 5 6 7  
Figs 1-17 to double scale, figs 93 to 114







EGYPTIAN AMULETS &c

1 cm 0 1 2 3  
 figs 8, 10, 11, 14, 16, 27, 42 to amulets made 27 to 376 words

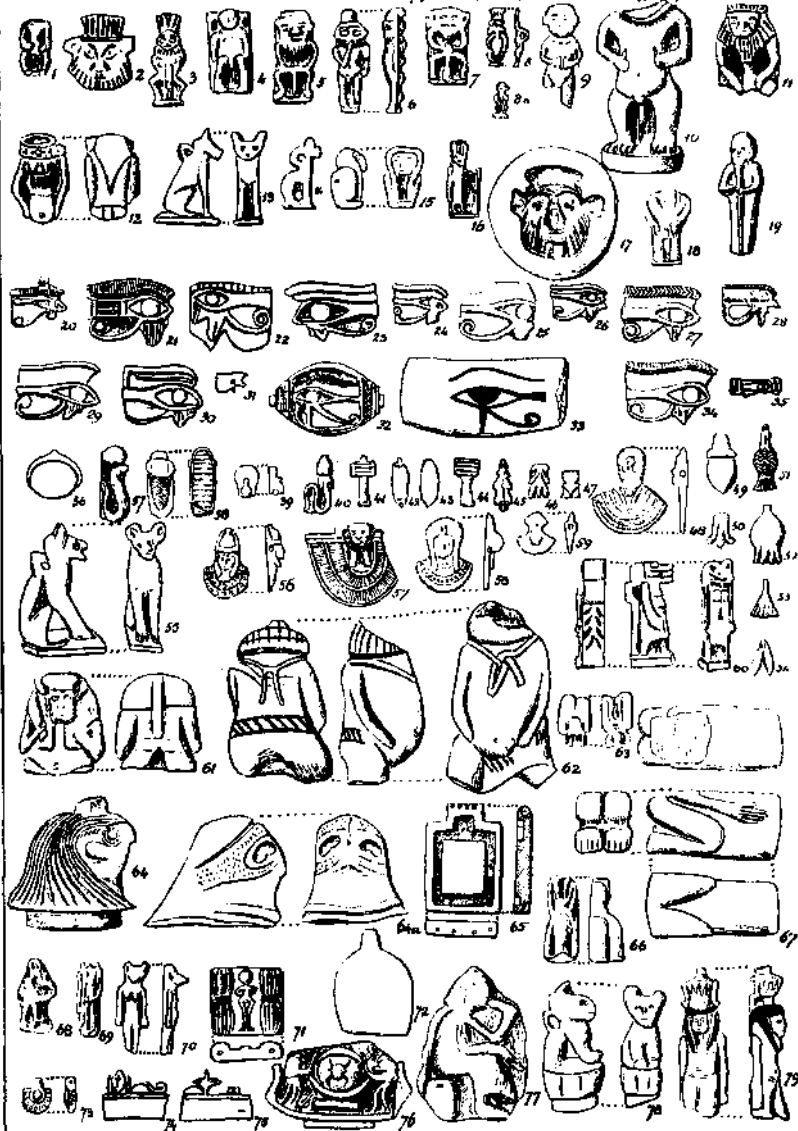

EGYPTIAN FIGURES & FAÏENCE

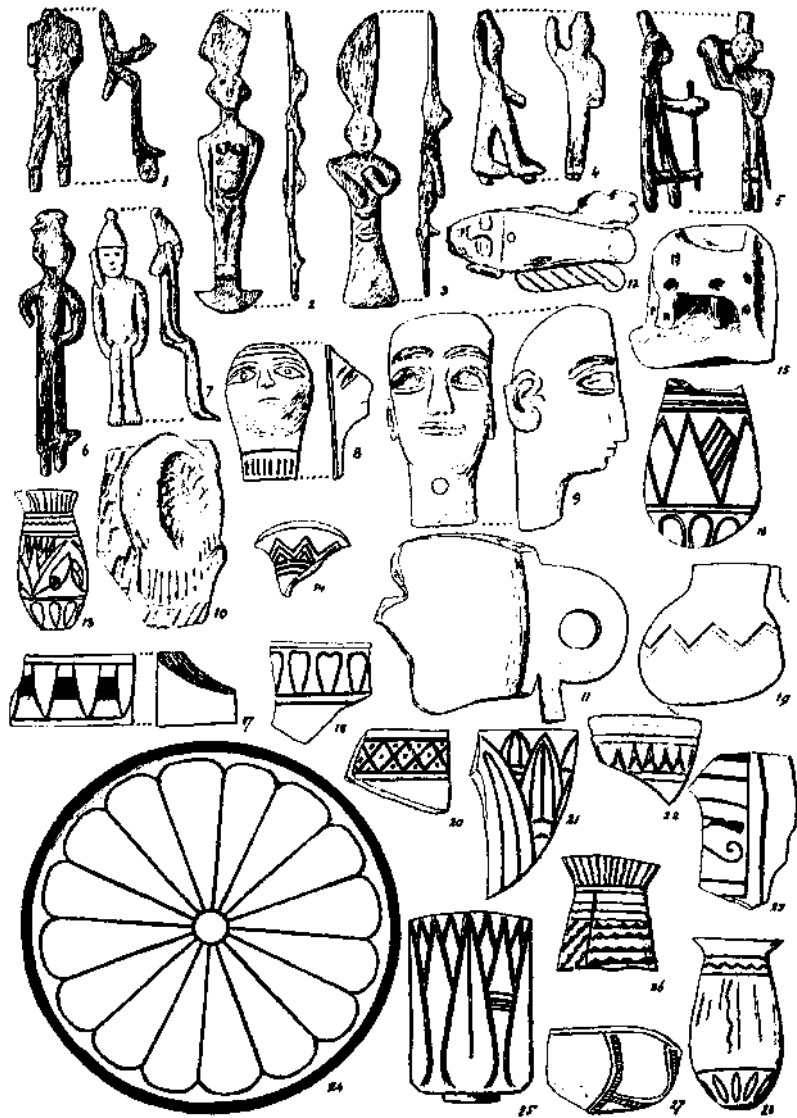





ALABASTER

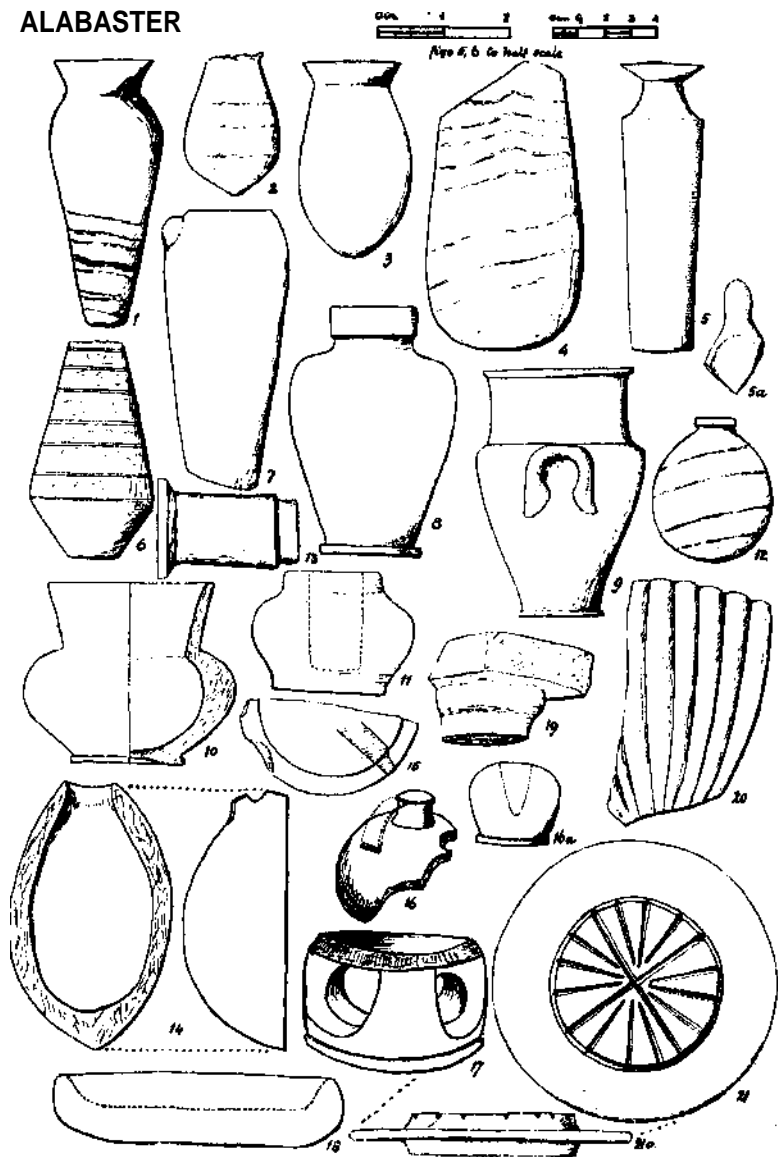

STONE SAUCERS

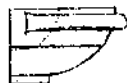
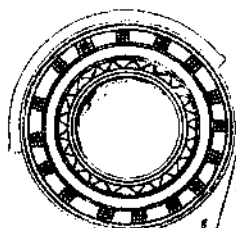
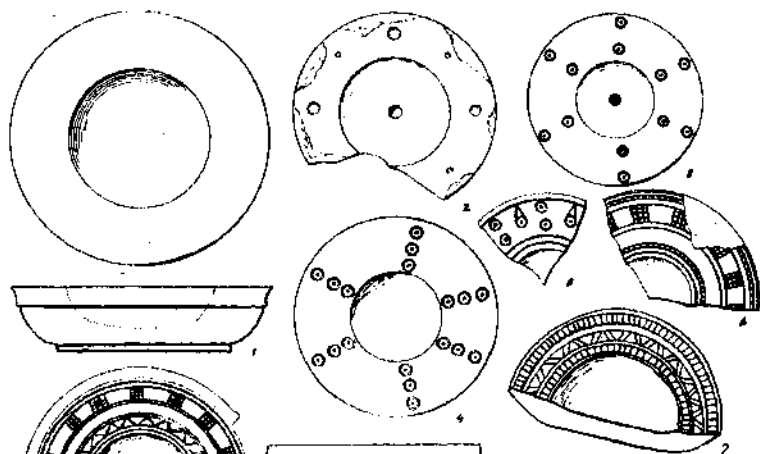
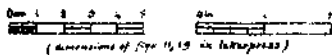

ALABASTER

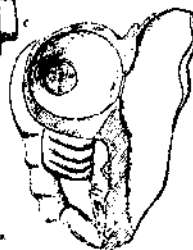
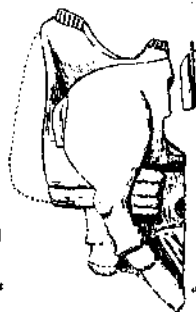





CYLINDERS &c.

double scale - 2, 7, 8, 11, 14, 17, 23 - 26, 30

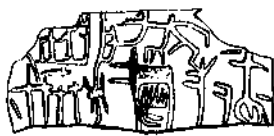
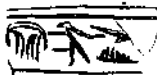
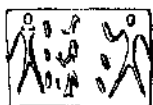
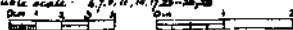

25' (10-4 cm)

# ARROW AND JAVELIN HEADS

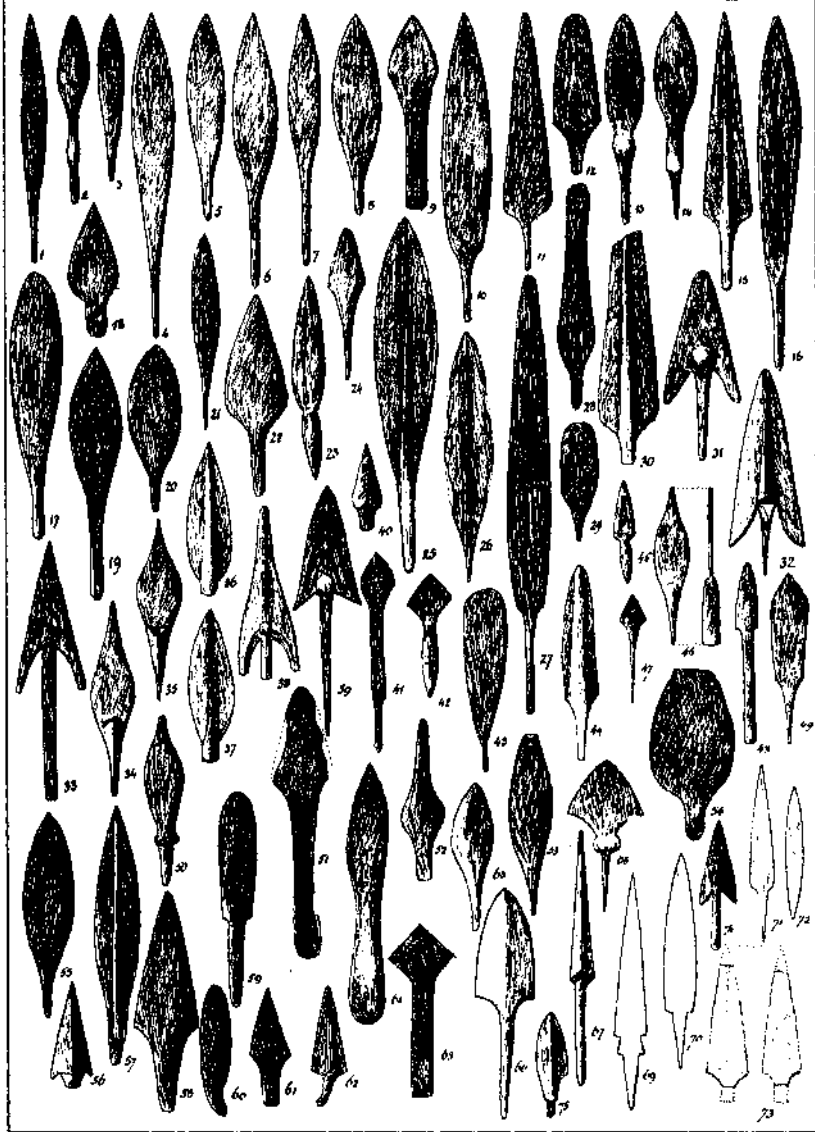





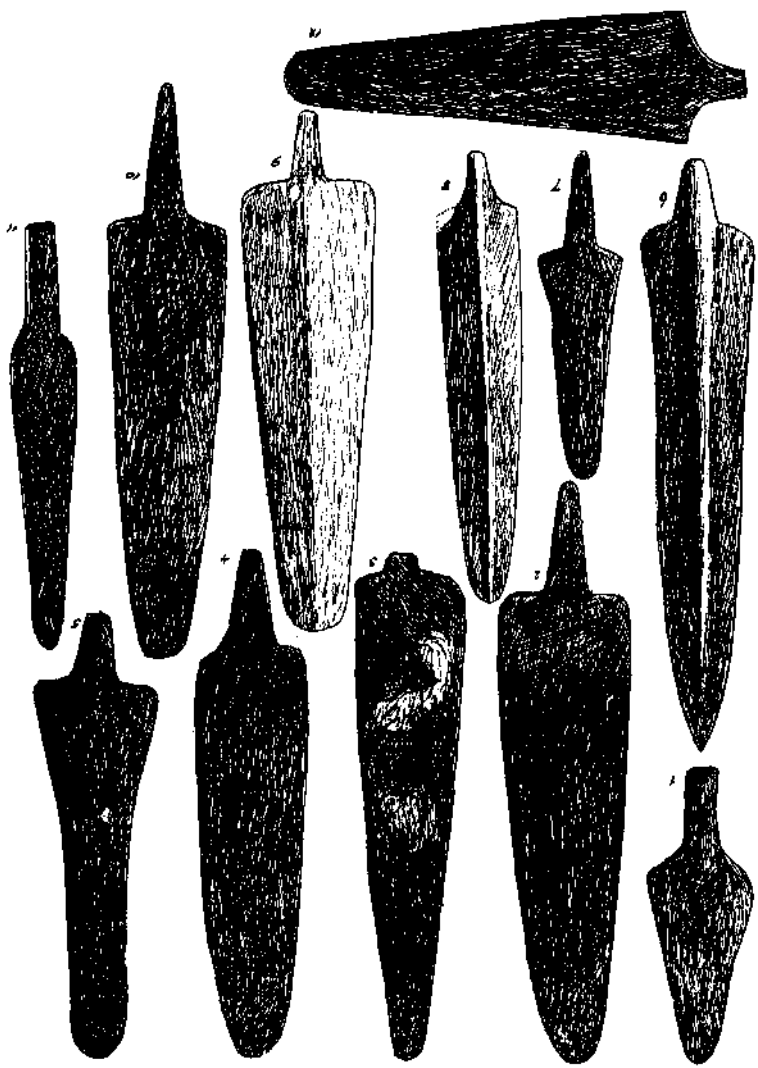

BRONZE SPEARHEADS

SPEARHEADS

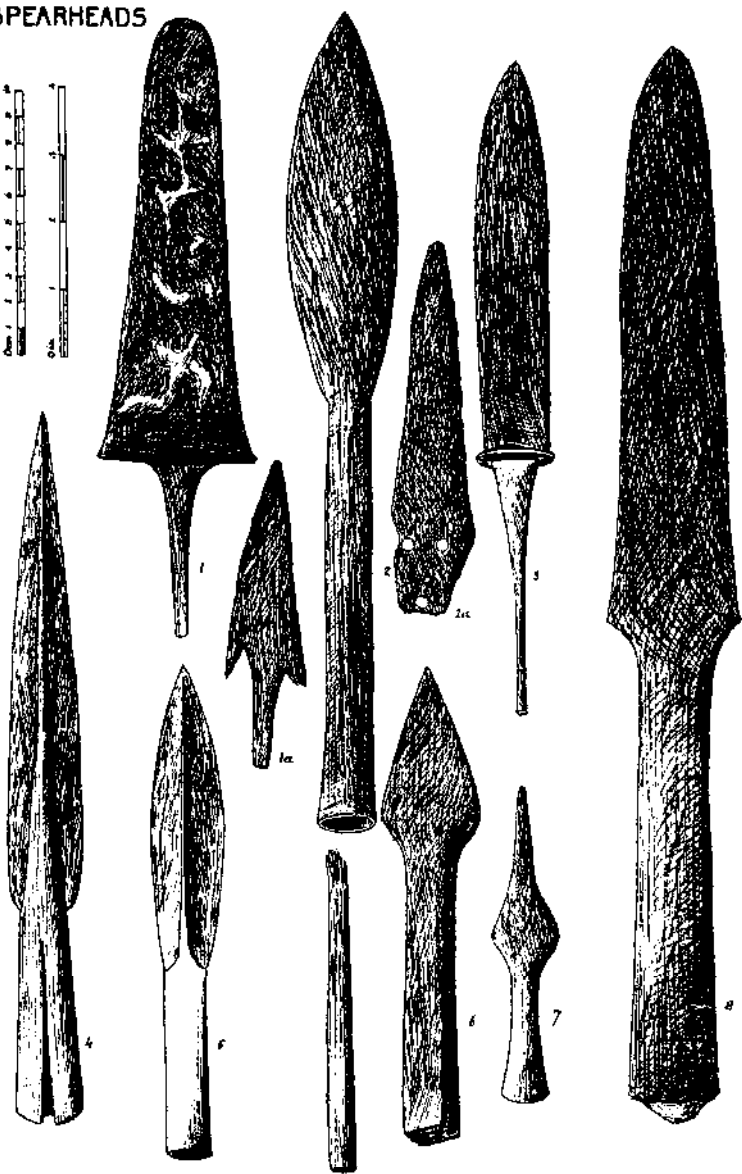





SWORDS &c.

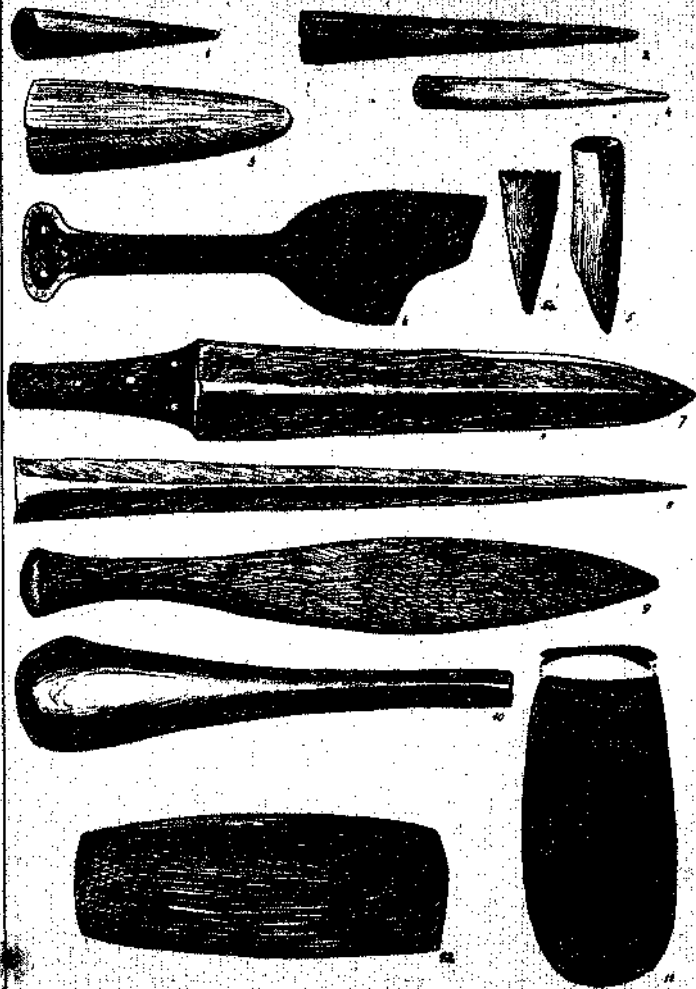
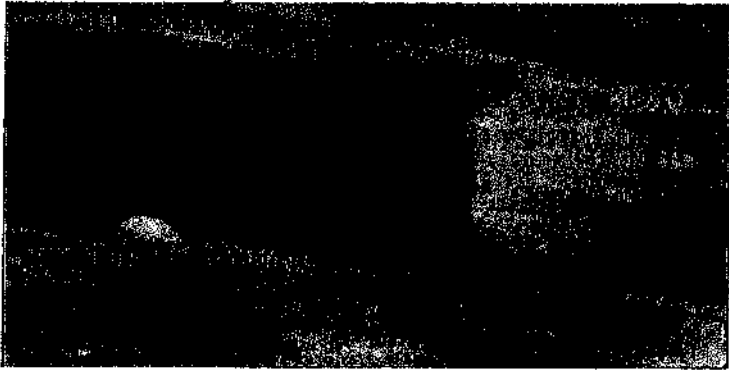
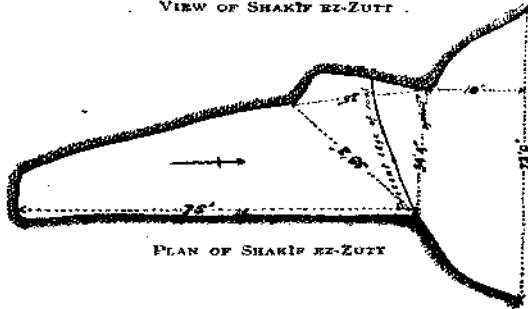

plate ccxix



VIEW OF SHAIKH EZ-ZUTTI



PLAN OF SHAIKH EZ-ZUTTI

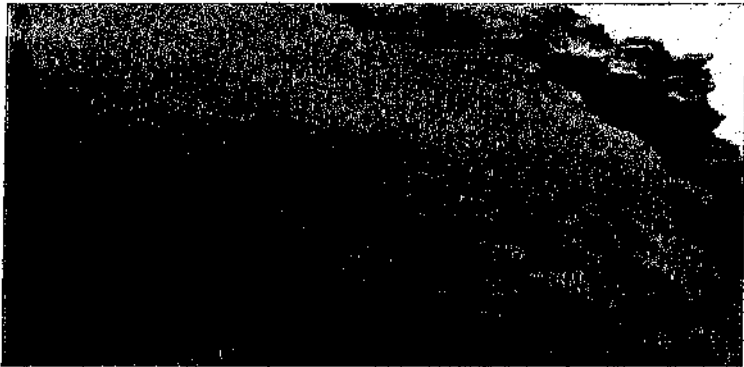

Rock SURFACE AT ENTRANCE



HATHOR-ASHTORETH PLAQUES







HATHOR-ASHTORETH PLAQUES, &c.



LIMESTONE FIGURES

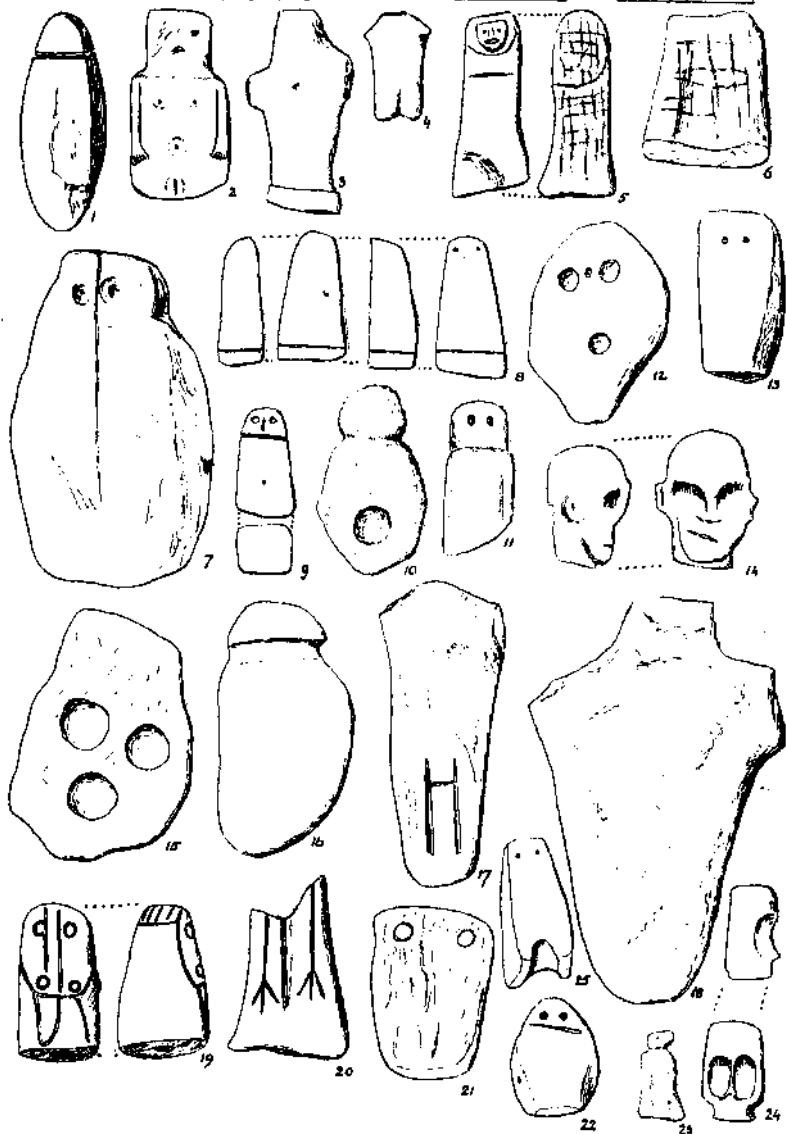





LIMESTONE FIGURES &c.

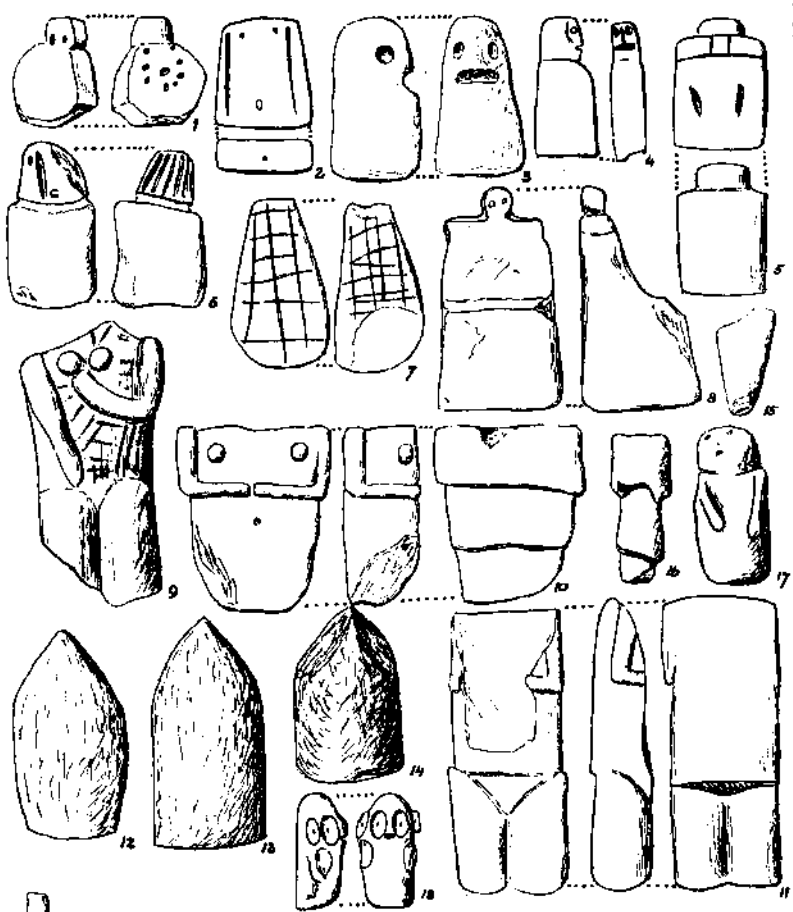

Standing Stones in V 29

## TABLES OF OFFERINGS

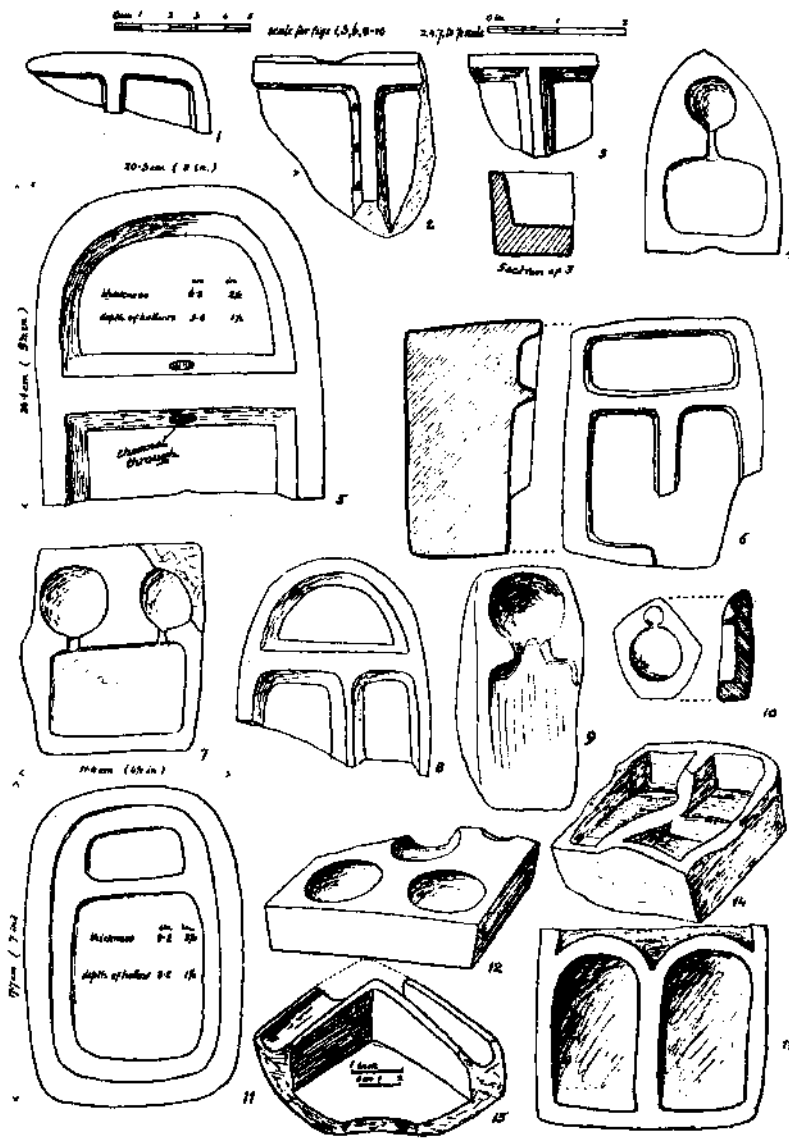





EX VOTO OFFERINGS &c.

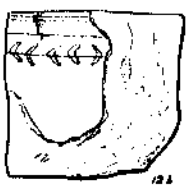
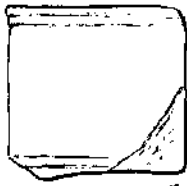
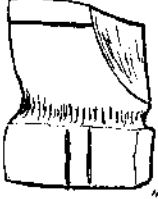
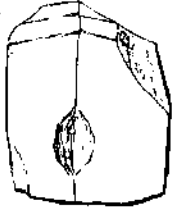
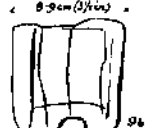
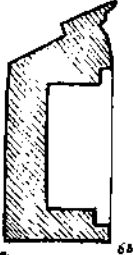
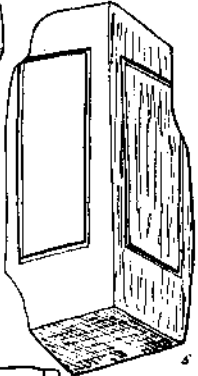
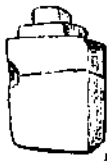

12a

12b

12c

12d

AMULETS

