

UNIVERSAL
LIBRARY

OU_160274

UNIVERSAL
LIBRARY

OUP—43—30-1-71—5,000

OSMANIA UNIVERSITY LIBRARY

Call No. 551.5 Accession No. p.g. 4069

363w
Author Blair, Thomas A.

Title weather elements; a Text

This book should be returned on or before the date last marked below.
in Sch. 2 on 10/11/2009

WEATHER ELEMENTS

PRENTICE-HALL GEOGRAPHY SERIES

CONSULTING EDITOR, NELS A. BENGTSON

WEATHER ELEMENTS

A Text in Elementary Meteorology

by

THOMAS A. BLAIR

*Senior Meteorologist, U. S. Weather Bureau
Associate Professor of Meteorology
University of Nebraska*

REVISED EDITION

NEW YORK
PRENTICE-HALL, INC.

1946

COPYRIGHT, 1937, 1942, BY
PRENTICE-HALL, INC.
70 FIFTH AVENUE, NEW YORK

ALL RIGHTS RESERVED. NO PART OF THIS BOOK MAY BE
REPRODUCED IN ANY FORM, BY MIMEOGRAPH OR ANY OTHER
MEANS, WITHOUT PERMISSION IN WRITING FROM THE
PUBLISHERS.

First Printing April, 1937
Second Printing February, 1938
Third Printing August, 1939
Fourth Printing December, 1940
Fifth Printing June, 1941

REVISED EDITION

Sixth Printing May, 1942
Seventh Printing September, 1942
Eighth Printing November, 1942
Ninth Printing February, 1943
Tenth Printing June, 1943
Eleventh Printing December, 1943
Twelfth Printing March, 1944
Thirteenth Printing May, 1946
Fourteenth Printing September, 1946

MANUFACTURED IN THE UNITED STATES OF AMERICA

Preface to the Revised Edition

THE science of meteorology has made continuous progress since this book was first published, five years ago. In the present limited revision the newer ideas and practices are introduced by numerous revisions in the text modifying many paragraphs and sections but without changing the general manner and order of treatment.

Some of the newer subjects discussed are latent instability, isentropic analysis, conditions necessary for copious rainfall, snow crystals in connection with the electrical charge in cumulonimbus clouds, and frontal activity in tropical cyclones. There are new drawings and a new discussion of the development of a traveling wave depression, and a new description of air masses embodying present-day classification and classification symbols. There are six new consecutive daily weather maps. Several other drawings have been revised and many minor changes made in the text. The discussion of the organization and procedure of the United States Weather Bureau is brought up to date.

T. A. BLAIR

Preface to First Edition

THIS book aims to present, concisely and systematically, an introduction to the science of meteorology in its present stage of development. My primary purpose is to set forth the facts and principles concerning the behavior and responses of the atmosphere in such a way as to enable the reader to acquire an elementary understanding of the physical processes underlying observed weather phenomena. An important secondary object is to present that general body of information about the weather and the present state of our knowledge concerning it, which it is believed that every intelligent person should possess in relation to this most important element of his environment.

Attention is given to the instruments and methods used in observing and measuring atmospheric conditions, to the complex effects of solar radiation, and to the interrelations of the various weather elements. Other subjects treated are the general circulation of the atmosphere and its modifications, the basis of weather forecasting, the general geographic distribution of the weather elements, and some of the relations of weather and climate to man and his varied life. A brief account is given of the electrical and optical phenomena of the atmosphere, and of the organization and activities of the United States Weather Bureau. Some knowledge of such matters is a necessary foundation for the study of geography, agriculture, and ecology, and of aeronautics, hydrology, and other branches of engineering. In addition, such knowledge is useful in a great variety of professions and occupations, notably in medicine, law, and

business. It is hoped, therefore, that the book will prove of value to persons of widely varying interests.

The discussions are necessarily brief and incomplete, and much interesting and valuable material has been omitted, but it is hoped that the most important phases of the subject have been treated in such a way as to arouse an abiding interest and lead to further reading. Meteorology is a growing science and at the present time is undergoing a rather rapid development and transition. An effort is made to present the modern aspects of the subject and to indicate the lines along which research is being conducted and progress being made.

The author of a book on elementary meteorology is inevitably indebted to the pioneers and leaders in the science of the weather in past generations, and also to a great number of contemporary students and investigators. No one can write such a book without becoming aware of meteorology's debt to Sir Napier Shaw and Dr. W. J. Humphreys, among present-day scientists. Dr. H. C. Willett and Mr. Jerome Namias have recently contributed notably to a knowledge of air masses and air-mass analysis. Nearly all the writers listed in the bibliography have provided facts or ideas which have been drawn upon in the preparation of this text. I regret that it has not been possible to identify and acknowledge the original source in each case. For general scope and for the general method of treatment of some of the fundamentals the author is conscious of the influence of the older textbooks, especially those by W. M. Davis and W. I. Milham.

To Dr. Nels A. Bengtson I am deeply grateful, not only for his critical reading of the entire manuscript, but also for his sympathetic interest in the book and his help in many of the details of its preparation. I am indebted to the Chief of the United States Weather Bureau for permission to publish this work, and to the scientific staff at the Central Office of the Weather Bureau for valuable criticisms and suggestions. My thanks are extended to

Mr. D. Keith Kinsey, who prepared nearly all the drawings, to Mr. H. Floreen for his cloud photographs, and to Professor J. C. Jensen, Mr. Otto Wiederanders, the United States Weather Bureau, and Julien P. Friez and Sons, for other photographic illustrations. The Taylor Instrument Companies have kindly given permission for the use of some material originally published in Tycos-Rochester (now Taylor-Rochester), and the Denoyer-Geppert Company has permitted the use of its base maps. My wife has given valued assistance and encouragement and has helped in reading the proofs.

T. A. BLAIR

Contents

CHAPTER	PAGE
I. THE ATMOSPHERE	1
Introduction	1
Composition of the atmosphere	4
Properties of the atmosphere	7
Height of the atmosphere	10
The elements of the weather	11
Summary	13
II. OBSERVING TEMPERATURE, PRESSURE, AND WIND ...	15
Temperature observations	15
Pressure observations	25
Wind observations	33
Summary	41
III. OBSERVING MOISTURE, SUNSHINE, VISIBILITY, AND UPPER AIR CONDITIONS	44
Humidity observations	44
Evaporation observations	55
Cloud observations	57
Precipitation observations	69
Sunshine observations	73
Observations of visibility and ceiling	75
Upper air observations	77
Summary	83
IV. SOLAR RADIATION AND ITS EFFECTS	86
Radiant energy	86
Insolation	89
Amount of insolation received at a fixed location	91
Direct effects of insolation	95
Conduction	99
Convection	101

CHAPTER	PAGE
IV. SOLAR RADIATION AND ITS EFFECTS (<i>Cont.</i>)	
Lapse rates ^a and stability	107
Atmospheric layers	115
Summary	122
V. CONDENSATION OF WATER IN THE ATMOSPHERE ...	126
Condensation on solid surfaces	126
Condensation above the earth's surface	130
Clouds and precipitation	134
Forms of precipitation	138
Summary	143
VI. INTERRELATIONS OF TEMPERATURE, PRESSURE, AND WIND	145
Pressure gradients	145
Gradient winds and surface winds	147
Winds due to local temperature differences ...	151
Monsoons	155
Polar-equatorial air movements	155
Summary	157
VII. THE GENERAL CIRCULATION	160
Yearly averages of pressure	160
January and July averages of pressure and winds	164
Upper air circulation	169
Latitudinal interchange of air	170
Summary	174
VIII. THE SECONDARY CIRCULATION	176
Weather maps	176
Barometric depressions	182
Anticyclones	186
Nature and origin of highs and lows	188
Mass movements and energy sources	196
Tropical cyclones	198
Summary	206
IX. LESSER DISTURBANCES	210
Thunderstorms	210
Tornadoes	220

CONTENTS

xiii

CHAPTER	PAGE
IX. LESSER DISTURBANCES (<i>Cont.</i>)	
Some special winds	226
Summary	230
X. WEATHER FORECASTING	233
Forecasting by study of pressure systems	233
Forecasting by analysis of air masses	236
Local forecasts and weather lore	248
Summary	252
XI. WORLD WEATHER	255
Variability of the weather	255
Persistence of the weather	259
Weather correlations	262
The oceans and the weather	266
The sun and the weather	270
Seasonal forecasting	272
Summary	274
XII. CLIMATE	277
Climatic elements	277
Distribution of temperature	279
General distribution of precipitation	289
Climatic zones	296
Climate as related to the physical features of the earth's surface	299
Cyclical changes of weather and climate	302
Climatic controls	314
Summary	317
XIII. CLIMATE AND MAN	321
Weather and health	321
Climate and culture	325
Agricultural meteorology	328
Aeronautical meteorology	333
Summary	337
XIV. ELECTRICAL AND OPTICAL PHENOMENA	339
Electrical phenomena	339
Optical phenomena	342
Summary	348

CHAPTER	PAGE
XV. THE UNITED STATES WEATHER BUREAU	350
Development of an official weather service in the United States	350
Present organization	352
Activities	354
Summary	368
APPENDIX I. Bibliography	370
APPENDIX II. Conversion factors and tables.....	376
APPENDIX III. Mean monthly and annual temperatures and precipitation (Tables)	380
APPENDIX IV. Climatological section centers of the United States Weather Bureau	386
INDEX	389

List of Illustrations

FIGURE	PAGE
1. Composition of dry air by volume	4
2. Relation of volume to expansive pressure in a given mass of gas	8
3. Thermometer scales compared	17
4. Maximum and minimum thermometers with Town- send support (photo)	19
5. Thermograph (photo)	20
6. Thermograph record at Lincoln, Nebraska	21
7. Instrument shelter and instruments (photo)	22
8. Typical curves of annual march and annual range of temperature	24
9. Two mercurial barometers, Fortin type (photo) ...	26
10. Barometer scales compared	27
11. Barograph (photo)	29
12. Barograph record at Lincoln, Nebraska	30
13. Robinson 4-cup anemometer (photo)	37
14. Anemoscope record	38
15. Wind rose for New York City	40
16. Whirled psychrometer (photo)	50
17. Hygrograph record at Lincoln, Nebraska	54
18. Class A evaporation station (photo)	56
19-32. Cloud types (15 photographs)	59-65
33. Standard 8-inch rain gage (photo)	70
34. Tipping-bucket rain gage	71
35. Electrical sunshine recorder (photo)	74
36. Pilot balloon observation (photo)	79
37. Six-hourly observations of the Weather Bureau ...	82
38. Diagrammatic representation of radiant energy spectrum	87
39. Position of the earth with reference to the sun on June 21st and December 21st	92

FIGURE	PAGE
40. Effect of angle of incidence	93
41. Interchange of heat in the air	100
42. Transfer of heat by convection	102
43. Convectational circulation in a liquid	102
44. Adiabatic changes of temperature	105
45. Lapse rates	109
46. Layers of the atmosphere	121
47. Orchard heaters (photo)	129
48. Penetrative convection	136
49. Snow crystals (photo)	139
50. Hailstones (photo)	140
51. Glaze—"Ice storm" (photo)	142
52. Isobars and pressure gradients	146
53. Curved isobaric surfaces	147
54. The three forces affecting moving air	149
55. Sea breeze	151
56. Land breeze	153
57. Mean annual pressure, world	161
58. Mean January pressure and wind direction, world ..	165
59. Mean July pressure and wind direction, world	166
60. Weather map, October 3, 1941	179
61. Weather map, October 4, 1941	180
62. Weather map, October 5, 1941	181
63. Conventional barometric depression	183
64. Typical paths of depressions	185
65. Conventional anticyclone	187
66. Typical paths of anticyclones	188
67. Stages in the development of a traveling depression	191
68. Frontal origin of anticyclone	194
69. Wedge of cold air invading a warm current	195
70. Pressure, wind, cloudiness, and rain in a tropical cyclone	199
71. Regions and generalized paths of tropical cyclones	203
72. Tropical hurricane of September 20, 1926	205
73. Cross section of typical local thunderstorm	211
74. Barograph record during thunderstorm	212
75. Average annual number of days with thunderstorms	216
76. Direct, branching lightning discharges (photo)	219

LIST OF ILLUSTRATIONS

xvii

FIGURE	PAGE
77. Ball lightning (photo)	220
78. Tornado at Gothenburg, Nebraska (photos) ..	222-223
79. Diagram of foehn wind	227
80. Dust storm (photo)	229
81. Weather map, October 6, 1941	245
82. Weather map, October 7, 1941	246
83. Weather map, October 8, 1941	247
84. Rain percentages at Dubuque, Iowa	250
85. Frequency polygon of January precipitation at Cleveland, Ohio	257
86. Frequency polygon for length of growing season at Indianapolis, Indiana	258
87. Departures of mean monthly temperatures from normal	261
88. Observed and calculated values of spring tempera- ture departures	265
89. Mean annual sea-level temperatures, world	281
90. Mean January temperatures at sea level, world	283
91. Mean July temperatures at sea level, world	284
92. Mean annual range of temperature, world	286
93. January mean daily ranges of temperature in the United States	288
94. Mean annual precipitation, world	290
95. Types of rainfall distribution by months	292
96. Average annual number of rainy days in the United States	294
97. Iowa precipitation, 1873-1934	305
98. Drought of 1930 in the United States	307
99. Drought of 1934 in the United States	308
100. Drought of 1936 in the United States	310
101. Secular trends of temperature	311
102. Relation between rainfall and yield of spring wheat	331
103. Aurora band just after sunset	341
104. Refraction of light	342
105. Atmospheric refraction	343
106. Path of light in primary and secondary rainbows ..	345
107. Halo phenomena	346

CHAPTER I

The Atmosphere

Introduction

As this earth turns on its axis and follows its elliptical orbit around the sun, it is forever attended and encompassed by a gaseous shell or envelope, which Shakespeare called "the empty, vast and wandering air." This encircling air is an integral and essential part of the earth. Because of its invisibility we frequently remain unconscious of its presence, but we feel its pressure when it moves rapidly past us, and we know that "when the trees bow down their heads the wind is passing by." It is an ever-moving air, not fixed like land, nor confined in basins and channels like water, but ever-present and all-pervading.

Air is the medium in which we live and move, the breath of life to man, animals, and plants. Without it this would be a dead and barren world. We can live for many days without food, for a few days without water, but for only a few minutes without air. The food that we eat and the clothing that we wear are composed in large part of elements obtained from the air. The water that falls on our fields is carried to them by the air. Air supports combustion and transmits sound. In addition to these primary and indispensable functions, air is made to serve us in many practical applications. It is a source of power to sailing ships and windmills. When compressed, it actuates the brakes of railroad trains and the trip-hammers of pneumatic tools; in many other ways it serves us, and finally, it furnishes a support and a highway for vast machines,

“as the heavens fill with commerce.” It is with the behavior of this intangible, colorless, and odorless, but all-important atmosphere that this book deals.

Meteorology.—*Meteorology* may be defined as the science of the atmosphere and its phenomena, those phenomena which we call, collectively, the weather. Because of their infinite variety and their intimate relation to all of our activities, the phenomena of the weather are subjects of never-ending interest. And they are not only of interest, but of great importance, since weather is the chief element in man's environment, far-reaching in its influence and affecting all phases of his life. One of the reasons for the daily interest in the weather in regions outside of the tropics is that it is new every morning. It is never stable for long but always in a state of becoming something different. In this it is typical of all nature, but since weather changes are more rapid and more noticeable than are most other natural changes, “changeable as the weather” has become a time-worn simile.

Meteorology combines physics and geography. It not only applies the principles of physics to the behavior of the air treated as a mixture of gases, but it considers the whole atmosphere and its movements as they are affected by such geographic factors as latitude, topography, altitude, and distribution of land and water. The geography of the globe is an essential factor in its weather. In so far as meteorology treats of the physics of the air, it is a branch of physics; in so far as it is descriptive and explanatory of the environment of man, as affecting his modes of life and his ways of making a living, it is a branch of geography. In combining the two to account for actual weather and climate, it is something different from either; it is a separate branch of science. Moreover, the facts and data accumulated in the study of weather and climate are capable of infinite application to the life of man. They are of importance in the study of history, geology, biology. They are used directly and daily by the farmer and the engineer, by

the physician, the lawyer, and the business man. Although the idea persists with many that meteorology and astronomy are closely related, there is, in fact, little practical connection, except as astronomical factors determine the amount and character of the radiation received from the sun.

The science of meteorology has advanced by the following steps:

1. The invention of instruments and methods for determining the condition of the air.
2. The use of these in the systematic accumulation of observational data.
3. The classification and organization of the accumulated data for the purpose of discovering and describing the condition of the atmosphere.
4. The development of physical theories to interpret and coördinate atmospheric processes.
5. The application to useful purposes of the knowledge thus acquired.

Some of the Greek philosophers, notably Hippocrates, Aristotle, and Theophrastus, approached the study of weather and climate in a scientific spirit and made considerable progress in interpreting the phenomena of the atmosphere, rather remarkable progress in view of the limited knowledge of physics and chemistry existing in their day. We derive the name meteorology from Aristotle's treatise, *Meteorologica*. This treatise included a discussion of much that we now call astronomy, physical geography, and geology, but about one third of it was devoted to atmospheric phenomena.

During the Middle Ages weather events were given many irrational and mystical interpretations. The weather was a matter of signs and portents, often assumed to be related to human conduct as warning or as punishment. Some of the mystery remains in many minds, and superstition still survives when men discuss the weather. And yet, the elementary facts about atmospheric phenomena and their

causes are simple and easily acquired, and they are necessary to an intelligent appreciation of our daily life. It is true, on the other hand, that very much is yet unknown about the behavior of the air. The atmosphere is so vast as to preclude, probably forever, the possibility of a complete analysis of its forces and activities. Therein lies an opportunity and a challenge for additional accumulation of facts and further investigation and research.

Composition of the Atmosphere

Upon examination, the air is found to be a complex affair, not a simple chemical element, nor even a compound, but an apparently accidental mixture of a number of gases. First, there are several of the chemical elements which remain permanently in gaseous form under all natural conditions. Second, gaseous water, known as water vapor, is a permanent part of this mixture. Under certain conditions, liquid and solid forms of water also occur in the air but these are not included in the definition of air. Finally, the air always contains, but not as essential ingredients, a very great number of solid particles of various natures, known collectively as dust.

Permanent gases.—The two permanent gases that make up 99 per cent of the volume of the air, after the water vapor and the dust particles have been removed, are the chemical elements, nitrogen and oxygen, which also, in combination with other elements,

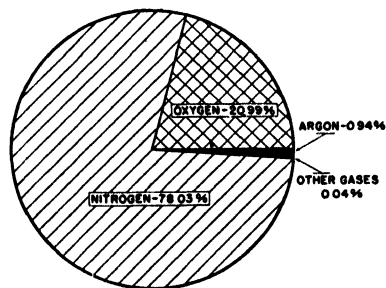

Fig. 1. Composition of Dry Air by Volume.

make up a large proportion of all living matter and of the earth's crust. Nitrogen forms about 78 per cent of the total volume of dry air, and oxygen about 21 per cent. Of the remaining 1 per cent the greater part is argon, and only about 0.04 per cent remains, of which

0.03 per cent is carbon dioxide and the remainder is neon, helium, krypton, hydrogen, xenon, ozone, and radon.

The relative percentages of the principal permanent gases remain remarkably constant throughout the world from the surface of the earth up to heights of several miles. We breathe the same air everywhere. Above about 20 kilometers (12.4 miles) there appears to be an increase in helium and a decrease in oxygen. Ozone and radon (radium emanation from the rocks of the earth's crust) exist in minute and variable quantities, ozone increasing with height and radon decreasing.

The active energizing element of the air is its oxygen, which combines readily with other chemical elements and is necessary to all life. The carbon dioxide which is exhaled by animals is absorbed by plants, and its oxygen constituent later released to the air. This reciprocal use by plants and animals plays a part in maintaining the constant ratio of these two gases. The waters of the ocean also exercise a control over the concentration of carbon dioxide in the air; when the amount of carbon dioxide increases, more is absorbed by the water; when it decreases, some of the gas returns to the atmosphere. The other permanent gases appear to have no special natural functions except to increase the density of the atmosphere and dilute its oxygen. But some soil bacteria take nitrogen from the air and make it available to feed the roots of plants, and man has also learned to utilize it. The rare gases, neon, krypton, and xenon, are also extracted from the air.

Water vapor.—Water vapor is contributed to the air by evaporation from water surfaces, soil, and living tissues. It is an all-important constituent of the atmosphere, but, unlike the other gases, is quite variable in amount, ranging from a minute proportion in the air of deserts to 4 per cent by volume in warm and humid air, as in a fog. Some water remains in the air as a gas at all temperatures; but the amount that may be mixed with the other gases of the air at low temperatures is very small compared with the

possible amount when the temperature is high. The importance of atmospheric moisture to life is so universally recognized that no additional emphasis need be given here. However, less well-known is the important role which it plays in the physical processes of the air; this will be fully explained later.

Dust.—The gases of the atmosphere maintain in suspension an immense number of non-gaseous substances of various kinds, aside from the liquid drops of water and solid particles of ice or snow, of which clouds and fog are composed. In addition to the visible dust which sometimes fills the air and darkens the sun in dry regions, the air always, or nearly always, carries small particles of organic matter, such as seeds, spores, and bacteria. Much more numerous, however, are the microscopic, inorganic particles to which the general name of dust is given. Some of these are the fine particles of soil or of smoke, or salts from ocean spray, which are lifted and diffused by the winds and rising air currents. The dust particles are naturally more numerous in the lower atmosphere, but some of them are carried to heights of several miles. Large numbers of even finer particles are thrown into the air by volcanic explosions, and many more result from the burning of meteors in the upper air, thus furnishing a supply of dust to the air at great heights.

Many of these particles approach molecular size and are not visible even under a powerful microscope, but they have an important function in the air. They furnish the nuclei on which condensation of water vapor begins, and they intercept some of the heat coming from the sun. When there is an unusual amount of such dust, as in a time of great volcanic activity, the result may be to reduce the average temperature of the globe. Dust plays a part in the creation of the varied colors of sunrise and sunset. For three years after the violent explosion of Krakatoa in the East Indies, near the equator, in 1883, brilliant twilight colors, attributed to the immense amount of ash erupted,

were seen around the world, as the dust gradually spread from its source until it encircled the globe. In mid-ocean the air has been found to contain from 500 to 2,000 of these microscopic and submicroscopic dust particles per cubic centimeter, and in dusty cities more than 100,000 per cubic centimeter. In the aggregate, large quantities of atmospheric dust are deposited at the earth's surface each year.

Properties of the Atmosphere

By the properties of the atmosphere we mean the essential qualities or attributes of the air and its various constituents, especially their physical qualities. Since the atmosphere is essentially a mixture of gases, it behaves as other gases do, according to the laws developed in the study of physics.

General characteristics.—The chief characteristics of gases are their extreme mobility, compressibility, and capacity for expansion. The atmosphere is sometimes called the "ocean of air," and winds are compared to streams of water, but when these analogies are used, the greater freedom with which air moves in all directions, its greater fluidity and mobility, should be kept in mind. A gas has neither definite shape nor size. We cannot have a vessel half full of air; a small amount of air will fill a large vessel completely and uniformly. (Strictly speaking, exact uniformity is not attained, because the air at any point in the vessel is compressed by the weight of the air above it. This effect is negligible for most purposes in dealing with small volumes of air but is of importance in considering the atmosphere as a whole.) This property of indefinite expansion is owing to the fact that gases themselves exert a pressure, tending to change their volume. This pressure is proportional to their density and their temperature, and is exerted in all directions. With it goes the property of great compressibility. The air is readily compressed, that is, its volume is decreased and its density increased, when pressure is applied to it, and it as readily expands when

the pressure is diminished. Under the same pressure it also expands with increase of temperature and becomes denser with decrease of temperature, as, indeed, do solids and liquids, in general, but gases change to a much greater degree and more uniformly.

Laws of gases.—The characteristics just described are more definitely expressed in the following gas laws. These apply with very close approximation to all the permanent gases of the air, but not so closely to water vapor. They refer to a fixed quantity (that is, mass) of gas.

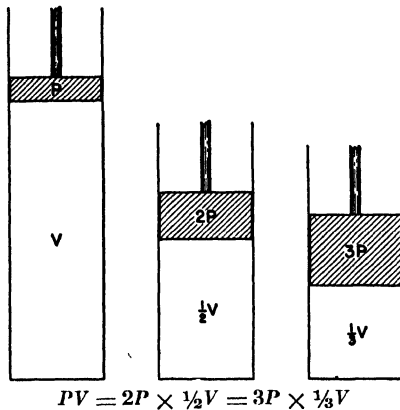

Fig. 2. Relation of Volume to Expansive Pressure in a Given Mass of Gas at Constant Temperature.

Boyle's Law.—At constant temperature the product of the pressure by the volume is constant. Stated otherwise, the volume of a given mass of gas varies inversely as the pressure on it, or the pressure which a given mass of gas exerts is inversely proportional to its volume, if the temperature is unchanged. Algebraically, this may be written: $PV=K$, a constant;

or comparing pressure and volume under different sets of conditions: $P_1V_1=P_2V_2=P_3V_3=\dots$. Since density means the ratio of the mass to the volume, density varies inversely as the volume, and therefore, the density of a gas is directly proportional to its pressure; or $P/D=K'$ at constant temperature.

Law of Charles and Gay-Lussac.—If we keep the volume of a mass of gas constant, and measure the ratio of the increase of its pressure to its original pressure for each rise of 1° in temperature, and, similarly, if we keep the pressure constant, and measure the ratio of its increase in volume to

its original volume, we find (1) that the two ratios are the same for any one gas, and (2) that they have very approximately the same numerical value for all gases. If the centigrade temperature scale is used, this ratio, or coefficient, is found to be $1/273$ of the pressure or the volume at 0°C . for each increase or decrease of 1°C . in temperature. Most liquids and solids also change volume as the temperature varies. What distinguishes the behavior of gases in this respect is that all gases have the same coefficient of expansion, but all liquids and solids do not. These facts about gases were discovered by the French scientists, Charles and Gay-Lussac, about the beginning of the 19th century.

Algebraically, these relations are expressed thus: If P_0 and P_t represent the pressures, and V_0 and V_t the volumes, of a mass of gas at the temperatures 0° and T° , respectively, then:

$$P_t = P_0 [1 + (1/273)T] \text{ at constant volume}$$

$$\text{and } V_t = V_0 [1 + (1/273)T] \text{ at constant pressure}$$

One consequence of the first equation is that at a temperature of -273°C . a gas ceases to exert any pressure, that is, its molecules cease to move. This temperature is called the absolute zero because, according to this law, no lower temperature can possibly exist, since neither pressure nor movement can be less than zero. Absolute temperatures are temperatures measured in centigrade degrees from the absolute zero. Combining the law of Charles and Gay-Lussac with Boyle's law, physicists obtain a single, simple equation expressing the relations between the pressure, volume, and temperature of a gas, namely: $PV=rT$, where T is the absolute temperature, and r is constant for a constant mass of any one gas, but varies with different gases.

Pressure.—The atmosphere is held to the earth by the force of gravity and therefore has weight which is manifest by a downward pressure. The weight of a cubic foot of air at sea level is about 12 ounces, or .08 pound. The

density of the air is, therefore, .08, expressed in pounds per cubic foot. The weight of the entire mass of air above the earth results in a pressure at sea level of about 14.7 pounds per square inch or about one ton per square foot. This pressure is transmitted laterally and upward as well as downward. Thus the lower air is compressed by the great weight of the air above. The temperature of the air also falls, as a general rule, with increased elevation, and this tends to increase the density, but the effect of the decreased pressure is more than sufficient to offset the opposing effect of decreased temperature, and, except in rare and temporary circumstances, the density decreases with elevation, rather rapidly at first, and then more and more slowly. The total mass of the air surrounding the earth has been calculated as 11.26×10^{18} pounds.

Height of the Atmosphere

The logical upper limit of the atmosphere is reached when it has become so much rarefied that its expansive force and the centrifugal force due to its rotation are equaled by the force of gravity holding it to the earth. Probably the air has no very definite limit but grows gradually thinner until it becomes imperceptible. Twilight colors give evidence of considerable air at a height of 40 miles (64 km.); meteors indicate the presence of gases at a height of 200 miles (322 km.), and auroras, at 300 miles (563 km.), but it is calculated that there is no appreciable pressure above 50 miles (80 km.). So great is the compressibility of the air that one half of the entire mass of the atmosphere is below 3.6 miles (5.8 km.), and 97 per cent of it is below 18 miles (29 km.). Thus, the top of Mt. McKinley, which has an elevation of 3.8 miles, is above more than half of the atmosphere. Recording instruments, which have been carried by balloons to heights of 23 miles, have given us some, but quite incomplete, direct instrumental knowledge of about 99 per cent of the air.

The Elements of the Weather

The first step in the development of a physical science is to observe, measure, and record phenomena as they occur. From his early beginnings man has doubtless given attention to weather phenomena, but for thousands of years his observations were haphazard and were mere personal impressions, soon forgotten or distorted. Although some rainfall measurements were made at an earlier date, it was about 300 years ago that man first began to measure the condition of the air and to record his observations for historical and comparative purposes. Such measurements necessarily awaited the invention of the thermometer and the barometer. The former is credited to Galileo in about the year 1590, and Torricelli invented the mercury barometer in 1643.

Shortly after the invention of these instruments, some systematic observations of the temperature and pressure of the air were begun, but such observations did not become widespread, continuous, and comparable with one another, until within the past 100 years. Today, when a meteorologist speaks of "making an observation" of the weather, he implies the careful use of instruments of precision for the purposes of determining and recording various physical facts about the condition of the atmosphere, by methods so standardized that his observations are comparable with others throughout the world. His observations, however, are unlike those of the physicist in the laboratory; they are comparable rather to those of the physician in observing and measuring the condition of the patient, because the constant and uncontrollable variations in the atmosphere are analogous to the changes in a living, moving organism.

The meteorological elements.—There are a number of physical properties and conditions of the atmosphere that may be observed and measured, and which, indeed, it is necessary to observe and measure if we wish to determine

what happens in the air and how it changes, or, even, if we wish to describe the weather as it is at a given time and place. The most important of these are: (1) the temperature of the air, (2) the pressure that it exerts, (3) the direction and velocity of its motion, (4) the humidity of the air, (5) the amount of cloudiness, and (6) the amount of precipitation. These are the six most important weather elements. Other items sometimes included in weather observations are visibility, the dust content of the air, and its electrical condition. It is evident that instruments giving results which can be set down in figures are necessary in order to obtain an accurate knowledge of conditions and to permit a comparison of weather at different times and places. In Chapters II and III the instruments and methods used in making the primary and essential observations are described briefly. Instruments and observational details have been largely standardized in this country by the United States Weather Bureau.

Weather and climate.—Weather is the condition of the atmosphere at a given time; climate implies the summation of weather conditions over a series of years. Climate is not merely the average weather; it includes also the extremes and variability of the weather elements, for example: the greatest and least rainfall, the highest and lowest temperatures, and the maximum wind velocity, for a given period. Since at any one place the weather is in constant flux, we need a long series of observations in order to have reasonably accurate information concerning the average and most frequent conditions and the probable variations.

Many of the facts in reference to the weather are expressed as *normal* values. In meteorology the word *normal* is used for the average, or mean, value of a weather element for a considerable period. Ordinarily a mean value is not considered a normal value unless there are at least 10 years of record, and much longer records are required in most cases to establish an approximately stable normal value. No such thing as an absolutely unchanging normal

is known to meteorology. The normal, or average, value of an element is not necessarily its most probable value.

Summary

Air is one of the physical essentials of life. The condition of the air constitutes a major part of the environment of man, and its diversities are reflected in his activities and culture. Meteorology attempts to discover and formulate the laws governing the behavior of the atmosphere and the distribution in time and place of those atmospheric conditions expressed by the words *weather* and *climate*.

The atmosphere is a mixture of permanent gases and water vapor. Of the permanent gases oxygen composes about one fifth of the volume of dry air, nitrogen nearly four fifths, and other gases about 1 per cent, and these ratios remain very nearly constant. The amount of water vapor varies from almost nothing to about 4 per cent of the volume. Fine dust particles are always present in the air in great, but variable, numbers. The properties of the atmosphere, of significance in interpreting its behavior, are: that it moves with great freedom; that it is easily compressed; and that it exerts an expansive pressure proportional to its temperature and its density. The density of the lower air is increased by the weight of the air above it. At sea level, air exerts a pressure in all directions of about 14.7 pounds per square inch. With increased elevation above the earth, the density and pressure decrease rapidly at first and then more slowly. In consequence of its great compressibility, 97 per cent of the air is below 18 miles, although there are evidences of some air to a height of 300 miles.

In describing the state of the air, several aspects, or elements, of its condition must be considered. The most important of these are temperature, pressure, wind, humidity, precipitation, sunshine, and cloudiness. Instruments are necessary to express accurately the condition of the air with respect to these properties. Weather refers to the

continuously variable condition of the air; climate, to the total long-time integration of these variations.

Problems

Assuming the pressure of the air to be 14.7 pounds per square inch and its density to be .08 pound per cubic foot, solve the following problems:

1. If air is removed from a vessel of 1 cubic foot capacity and of a total surface area of 800 square inches until the density is $\frac{1}{3}$ that of the outside air, what is the pressure on the vessel tending to crush it?
2. What is the weight of the air remaining in the vessel?
3. What volume of outside air is used to inflate an automobile tire to a pressure of 32 pounds per square inch in excess of the outside pressure, if the volume of the tube when inflated is 1,400 cubic inches?
4. What is the density of the air in the tube?
5. What is the weight of the air in the tube?

CHAPTER II

Observing Temperature, Pressure, and Wind

Temperature Observations

A weather element of primary concern is temperature, meaning the temperature of the air. Temperature in many parts of the world is subject to wide extremes and sudden changes; it is a weather element to which human life, and also plant and animal life, are sensitive; it is an important factor in determining the conditions of life and the productiveness of the soil in the different regions of the world; the varying temperature of the air is responsible for many other weather changes. These are some of the reasons for the importance of temperature measurements.

Nature of heat and temperature.—According to the molecular explanation of the constitution of matter, all substances are made up of molecules in more or less rapid motion among themselves. As the velocity of its intermolecular motion increases, the temperature of a body rises; that is, the temperature of a body is proportional to the so-called mean square velocity of its molecules. Matter in motion possesses energy; it is capable of exerting a force and of doing work; and the energy due to molecular motion is called heat. Heat is, therefore, a form of energy, and a measurable quantity, although not a substance. It may be transformed into other expressions of energy, mechanical work, for example. Although the human body is responsive to atmospheric temperatures, it is not an accurate instru-

ment for the measurement of the temperature of the air. For this purpose we need thermometers.

Thermometers.—Thermometers are instruments designed to respond uniformly to changes of temperature. There are various types and forms of temperature-measuring instruments for special purposes. The thermometer in common use for measuring the temperature of the air consists of a glass tube with a small uniform bore, expanded into a bulb at one end, and sealed at the other end. The bulb and a portion of the tube are filled with a liquid, usually mercury, and there is a vacuum above the liquid in the tube. The height of the liquid in the tube changes as the temperature of the mercury changes, because mercury, like other substances, expands as its temperature increases and contracts as its temperature decreases. The change in volume of the mercury is assumed to be exactly proportional to the change in temperature. The glass of the thermometer responds to temperature changes also, but the coefficient of expansion of mercury is about seven times that of glass.

The height of the liquid in the tube, when the thermometer is at the temperature of melting ice, is accurately determined and marked upon the glass, and similarly a point is marked indicating the temperature of boiling water under standard conditions of pressure. When these two "fixed points" have been determined, the distance between them on the tube is divided into a number of equal divisions, called degrees, and the divisions may be extended beyond these two points in each direction. For meteorological purposes, the scale is not extended to the boiling point of water, but it is extended below the freezing point.

On the *Fahrenheit* thermometer, invented by a German physicist of that name early in the 18th century but now in common use only in English-speaking countries, the temperature of melting ice is called 32° and that of boiling water, 212° . On the *centigrade* scale these two points are called 0° and 100° , respectively. The centigrade ther-

momometer is also sometimes called the Celsius thermometer after the Swedish astronomer who invented it in 1742. Temperatures below the zero of either scale are written with a minus sign. The zero of the Fahrenheit scale is within a few degrees of the temperature of a mixture of ice and salt. A change in temperature from 32° to 212° , being a change of 180° , on the Fahrenheit scale, corresponds to a change of 100° on the centigrade scale, making each Fahrenheit degree equal to $5/9$ of a centigrade degree. For scientific purposes it is preferable to use the scale which has its zero at -273°C ., and ascends in centigrade degrees. This is called the *absolute scale* and indicated by *A*, following the number.¹ The following formulas may be used to convert from one scale to another:

$$C = 5/9 (F - 32) = A - 273$$

$$F = 9/5 C + 32$$

$$A = C + 273$$

An accurate thermometer meets the following requirements: the bore is uniform, the fixed points are accurately determined, and the graduations are correctly spaced and etched on the stem. It contains a suitable fluid, one that

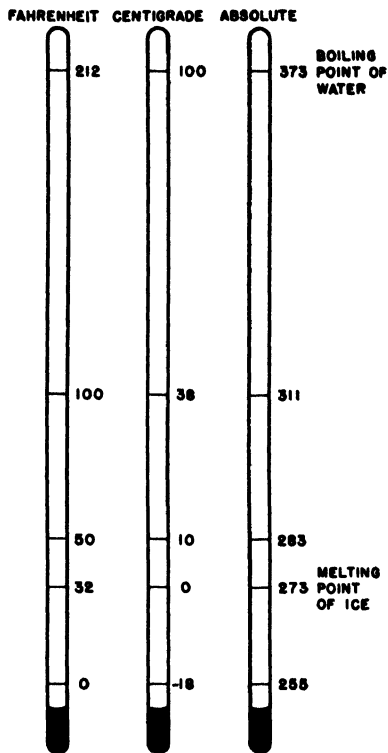

Fig. 3. Thermometer Scales Compared.

¹ Strictly speaking, it is not in exact agreement with the absolute scale, and Shaw calls it the *tercentesimal* scale, indicated by the symbol "t."

does not freeze at the temperatures to be measured and does not readily vaporize nor decompose. To meet the requirement of a non-freezing liquid, alcohol is used instead of mercury under very cold conditions, for mercury freezes at -38.7°F . The size and shape of the bulb and the size of the bore determine the instrument's sensitiveness and quickness of response. If the mass of mercury in the bulb is large, it will be slow in acquiring the temperature of the air, but a small change of temperature will produce a great movement in the tube. Such a thermometer is sensitive and sluggish. A smaller mass of mercury will respond more quickly, but small changes of temperature will not be so readable. A thermometer with a cylindrical bulb will respond more quickly than one with a spherical bulb of the same volume because of the greater surface of the cylinder.

Maximum thermometers.—Special thermometers are used for obtaining the highest and lowest temperatures occurring during any interval. The maximum thermometer has 2 funnel-shaped enlargements in the bore just above the bulb, through which the mercury moves up the stem in a series of jumps as the temperature rises, but does not go back as the temperature falls. The top of the column therefore remains at the highest point reached since the last setting of the thermometer. The maximum thermometer is set by whirling it around a mounting near its upper end. The centrifugal force thus generated forces the mercury back into the bulb. After setting, the thermometer indicates the correct temperature at the time, called the current temperature. The maximum thermometer should be mounted in a horizontal position to lessen the tendency for the mercury to retreat into the bulb.

Minimum thermometers.—The liquid used in the minimum thermometer is alcohol, and a small, glass, dumbbell-shaped index is placed within the stem. The instrument is mounted horizontally, with the index within the liquid and in contact with its surface at the end of the column. As the temperature falls and the column shortens, the index

is carried toward the bulb by the surface tension of the liquid. When the temperature rises, the liquid flows past the index and leaves it at the lowest temperature reached. After the minimum temperature is read, the index is returned to the top of the liquid, which is the current temperature, by simply turning the thermometer bulb end up. Thus, by making readings of a maximum and a minimum thermometer once a day, the highest and lowest temperatures reached during the twenty-four hours are obtained. Such instruments are called registering thermometers.

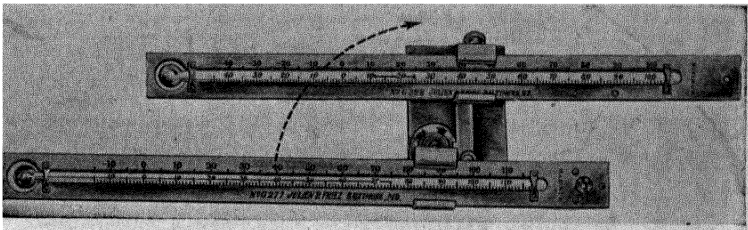

Fig. 4. Maximum and Minimum Thermometers with Townsend Support.
Courtesy, J. P. Friez & Sons, Baltimore, Md.

Thermographs.—Various types of recording thermometers, or thermographs, are used to obtain a continuous record of the temperature. In the type used by the United States Weather Bureau a flattened, curved metal tube is filled with liquid, sealed, and fastened rigidly at one end. With change of temperature there is unequal expansion or contraction of the liquid and the metal, producing a change of curvature in the tube, and moving the free end. This movement is communicated to a pen which is thus caused to move up or down on a drum that is being slowly rotated by a clock within it. In this manner, a continuous record of the temperature is traced on a ruled sheet surrounding the rotating drum. Such a record is less accurate than one obtained by readings of a mercury thermometer, but if the thermograph trace is checked at frequent intervals by comparison with an accurate thermometer, similarly exposed, and corrections made for the differences found,

the results are sufficiently accurate for general meteorological purposes.

Obtaining the temperature of the air.—To determine the air's temperature more is required than an accurate thermometer. It is equally important to make sure that the thermometer assumes the temperature of the air. A ther-

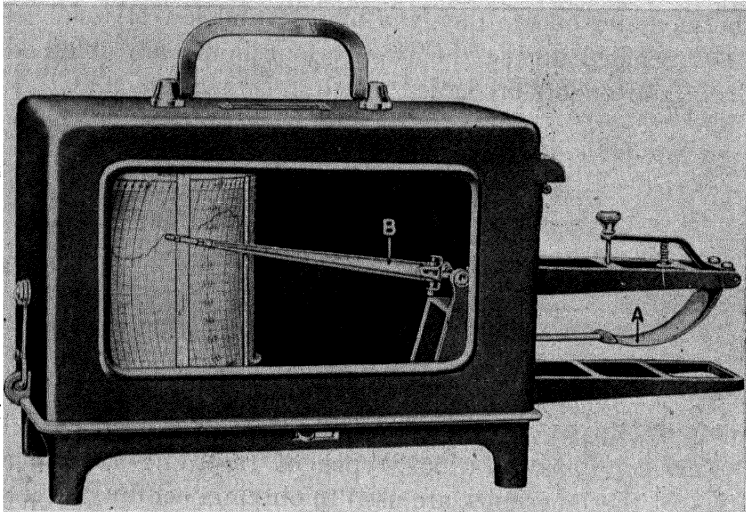

Fig. 5. Thermograph, a Recording Air Thermometer with Weekly Clock Movement Within the Cylinder. Temperature changes cause changes in the curvature of the flattened tube, *A*, resulting in vertical movements of the arm, *B*. *Courtesy, J. P. Friez & Sons, Baltimore, Md.*

mometer indicates its own temperature, the temperature of its bulb and liquid. Frequently that is not the same as the temperature of the air surrounding it. If the thermometer is exposed to direct sunshine or to reflected heat from ground or buildings, it becomes hotter than the air around it. If it is close to a good radiating surface at night, it becomes colder than the air. If it is exposed where the air does not move freely, it may indicate the temperature of the air immediately around it, but not of the general mass of air. These are some of the reasons why even good thermometers disagree. Most common exposures of privately

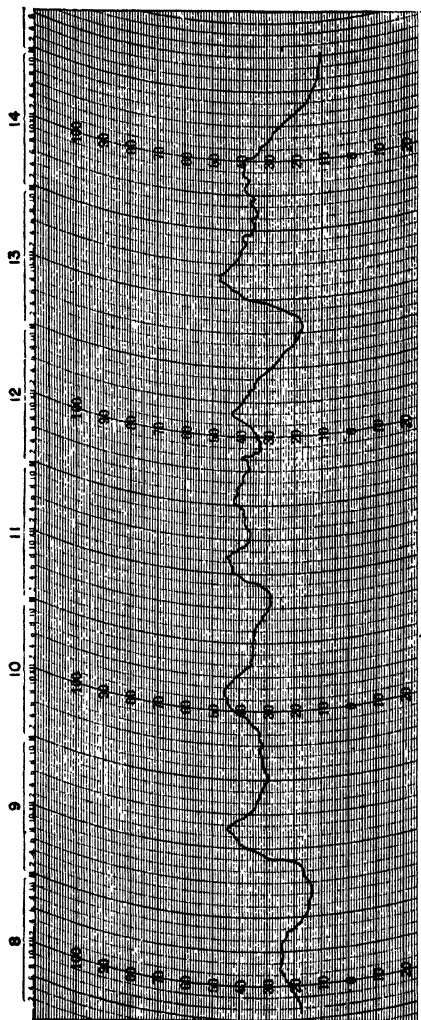

Fig. 6. Thermograph Record Showing Diurnal and Irregular Changes of Temperature at Lincoln, Nebraska, Jan. 8-15, 1936.

owned thermometers are faulty, and proper exposure is just as important as a good thermometer. There often are actual differences in air temperature within short distances, and thermometers in the same city should not all agree, but in many cases the disagreement is owing to a failure to secure the temperature of the moving mass of air.

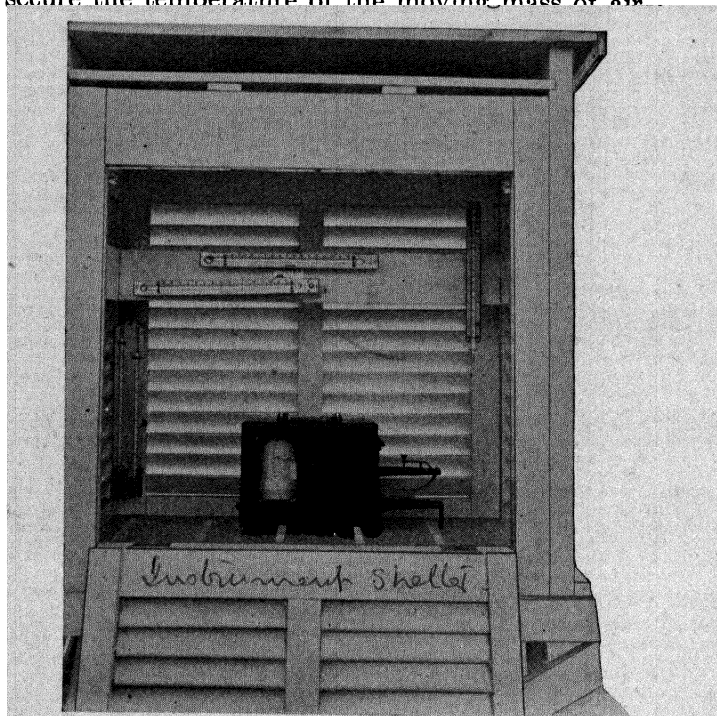

Fig. 7. Instrument Shelter with Door Open and Instruments in Place.
Courtesy, U. S. Weather Bureau, Washington, D. C.

The aim in meteorology is to learn the temperature of the freely moving air. To accomplish this result thermometers are exposed in such a way as to screen or shelter them from other influences. The *instrument shelter* furnished by the Weather Bureau to its coöperative observers is a box with a base about 2 by 2½ feet, and about 33 inches high. It has a sloping double roof with open air space between. All four sides are louvered to permit free move-

ment of air through it while protecting the instruments from sunshine, rain, and snow. The bottom is nearly closed but permits some movement of air through it. It is preferably mounted over sod, about 5 feet above the ground, to get above the influence of the surface temperature, and into a layer of air which is moving freely. Shelters embodying the same principles are used in meteorological services throughout the world.

Summarizing temperature observations.—Standardized observations of temperature have been made in some places in Europe for more than 100 years, and in the United States for more than 50 years. Many stations in each state have records longer than 25 years. For stations having a sufficient length of record, normal annual, monthly, daily, and hourly values may be obtained; also the mean maximum and minimum temperatures, and the actual extremes of highest and lowest temperature. Monthly and annual temperature normals based on 10 years of record are frequently used, but 30 to 40 years give more trustworthy normals. Hourly values are read from the thermograph sheets after correction. The mean temperature for a given day may be obtained by taking the mean of the 24 hourly readings, but the sum of the maximum and minimum divided by two is often used instead. For certain days the means obtained in these two ways may differ by as much as two or three degrees, but on the average the differences are negligible.

From the hourly values the *daily march* of temperature may be learned, by which we mean the regular progress of the temperature from low to high points during the day. On the average the highest temperature for the day occurs, not at noon, but in mid-afternoon, between 2 and 5 P.M. Most heat is received from the sun at noon, but during a portion of the afternoon, the earth and the air near it continue to receive more heat than they lose, and hence the temperature continues to rise until a balance between incoming and outgoing heat is reached. This delay in the

occurrence of the maximum until a few hours after noon is known as the *retardation* of the maximum. From the time of the maximum the temperature usually falls rather rapidly until about 8 to 10 P.M., and then more slowly until additional heat is again received from the sun. The time of the minimum is therefore about sunrise. These are average conditions; on any one day there may be irregular fluctua-

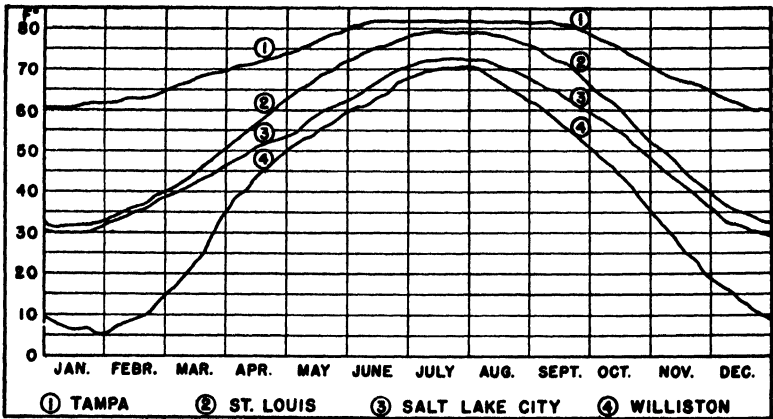

Fig. 8. Typical Curves of Annual March and Annual Range of Temperature.

tions which upset this regular march of temperature. The difference between the highest and lowest temperatures for any day is called the *daily range* of temperature. Different daily ranges indicate important climatic differences. For example, the average daily range at Key West, Florida, is about 10° , and at Winnemucca, Nevada, about 30° , indicating that Key West has little change in temperature from day to night and Winnemucca a large change.

The *annual march* of temperature in most parts of the Northern Hemisphere makes January the coldest month and July the warmest. The reverse is true in the Southern Hemisphere. In the interior of the United States, daily normals of temperature reach a maximum about July 15–25 and a minimum about January 15–25, but the most heat is

received June 21–22 and the least, December 21–22. There is thus a retardation of both maxima and minima of about one month. Where temperatures are influenced by large bodies of water the retardation is often greater than one month. In middle latitudes, individual years are marked by great irregularity in the march of temperature; that is, by irregularly alternating spells of warm and cool weather of unequal length, so that in a given year June or August may be warmer than July, and December or February colder than January. By the *annual range* of temperature is meant the difference between the mean temperature of the warmest and the coldest month.

Pressure Observations

The pressure of the air at a given place is a force exerted in all directions in consequence of the weight of all the air above it. As a result of the air's constant and complex movements and the changes in its temperature and its water vapor content, the weight of air above a fixed point is continually changing. The pressure therefore, like the temperature, is never constant for long, but unlike temperature changes, variations in pressure are not ordinarily perceptible to human senses. They are, nevertheless, an important feature of the weather by reason of their causal relations to other weather changes.

Mercury barometers.—The instrument used in meteorology for accurate measurements of the pressure is the mercury barometer. If a glass tube about 3 feet long be filled with mercury and then inverted and its open end immersed in a cup of mercury, the mercury will flow out of the tube into the cup until the weight of the column in the tube (above the surface of the liquid in the cup) is balanced by the pressure of the air upon an equal cross-section of the liquid surface. The length of the column of mercury thus becomes a measure of the force exerted by the pressure of the air. This is the instrument invented by Torricelli in

1643. The instruments in use today are only mechanical refinements of Torricelli's barometer, to facilitate accurate reading and safer handling.

In the Fortin type of mercury barometer in use by the Weather Bureau, the tube and the cup, or cistern, are in-

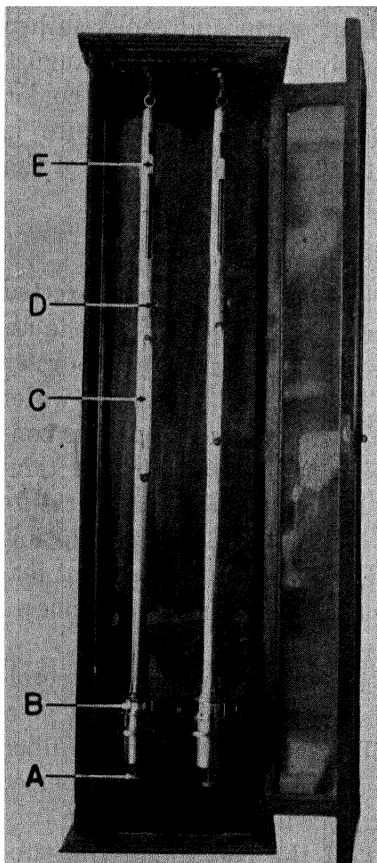

Fig. 9. Two Mercurial Barometers, Fortin Type. *A*, screw for adjusting level of mercury in cistern; *B*, level of the mercury in the cistern; *C*, attached thermometer; *D*, screw for adjusting movable vernier scale to the top of the mercury in the column; *E*, vernier scale. *Courtesy, U. S. Weather Bureau, Washington, D. C.*

closed in a brass case on which is marked the scale for reading the height of the column. The cistern has a flexible leather bottom to which is attached an adjusting screw by which the level of the mercury in the cistern is set to the fixed zero point of the scale. The zero of the scale is indicated by an ivory pointer. A thermometer is attached to the brass frame.

Units.—In this country the barometer scale is usually graduated in inches. In countries where the metric system is in use, the scale is marked in millimeters. When we say that the barometer reads 29.92 inches or 760 mm. we mean that the pressure of the air supports a column of mercury of that length. This value, 29.92 inches or 760 mm., is taken as the normal value of the pressure at sea level at latitude 45° , and is called the normal atmos-

phere, or simply *one atmosphere*. There has now come into general scientific use another unit of atmospheric pressure, called the *bar*, which is not a measure of length but a unit of force and therefore a more logical unit for measurement of pressure. Barometer scales using this unit are marked in *millibars* (mb.), thousandths of a bar. The bar in meteorological usage is equal to 1,000,000 dynes per square centimeter. A *dyne* is a unit of force which is approximately equal to the weight of a milligram. Under standard conditions of temperature and gravity a pressure of 29.53 inches = 1 bar = 1,000 millibars. The International Committee on Air Navigation has adopted as a standard atmosphere a pressure of 1013.2 millibars (29.92 inches) at a temperature of 15°C. (59°F.).

Corrections.—The length of a mercury column which a given pressure of air will support depends upon the density of the mercury, and this changes with the temperature. Therefore, to make an accurate pressure reading we must take into account the temperature of the mercury, and to compare readings at different times or places we must make a *temperature correction*. For this purpose a thermometer is attached to the barometer, and all readings are corrected to what they would be at a standard temperature. The standard in use for the temperature of the mercury is 32°F. The force of gravity varies over the earth's surface, de-

IN	MM	MB
31.00	787	1050
30.00	762	1016
29.92	760	1013
29.53	750	1000
29.00	737	982
28.00	711	948
27.00	686	914
IN = 25.4 MM = 33.86 MB		

Fig. 10. Barometer Scales Compared.

creasing from the poles to the equator. Hence the same actual pressure would raise the mercury higher at the equator than at the poles, because it weighs less at the equator, and it is necessary to make a *correction for gravity*, depending upon the latitude. The standard value of gravity adopted is 980.665 dynes, which is approximately the average value at sea level in latitude 45° .

Each barometer, before being put into use, should be compared with a standard precision instrument, and each is usually found to have certain divergences due to scale inaccuracies and capillarity, and these are grouped together under the name of *instrumental errors*. For usual heights of the barometer near sea level the corrections to be added algebraically to the observed readings vary for temperature from about 0.08 inch at 0°F . to about -0.19 inch at 100°F ., and for gravity from about -0.08 at the equator to about 0.08 at the poles. In a well-made instrument the instrumental errors are less than 0.01 inch. When these corrections are applied to the observed height of the barometer, the resulting reading is the *station pressure*, that is, the pressure at a definite place and time.

Aneroid barometers.—Another instrument in general use for the measurement of pressure is the aneroid barometer. It consists essentially of a metal box, or chamber, with thin, elastic, corrugated top and bottom. This chamber is hermetically sealed after being nearly exhausted of air, and is kept from collapsing by a strong spring within it. The flexible top and bottom then respond sensitively to pressure changes, and the resulting movements are communicated to an index hand moving over a dial. Aneroid barometers are compensated for temperature, and require no gravity correction; the station pressure is read directly from the dial. Instrumental errors, however, are considerable and variable, and these instruments are less reliable than mercury barometers, and should be checked frequently with them. Aneroids are light and easily carried without injury, if not subjected to severe jarring, and are therefore very useful for

travelers and explorers, and for use on airplanes and vessels at sea.

A *barograph* is an aneroid barometer that makes a continuous record of the pressure. It consists of several metallic chambers, one on top of the other. The combined motion of these is communicated to a lever, terminating in a pen. The pen writes a record of the pressure upon a

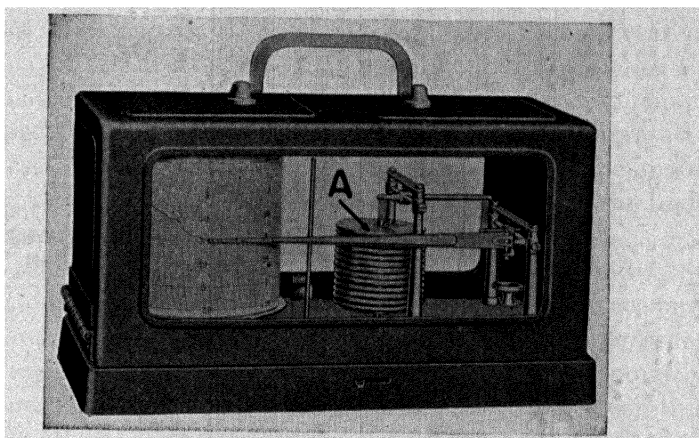

Fig. 11. Barograph, a Recording Aneroid Barometer with Weekly Clock Movement Within the Cylinder. The metallic chambers, A, are exhausted of air. Changing air pressure results in their compression or expansion, which causes a vertical movement of the pen. *Courtesy, J. P. Friez & Sons, Baltimore, Md.*

ruled sheet of paper wound around a drum, while the drum is being rotated slowly by a clock within it. The readings of the barographs in use by the Weather Bureau are corrected twice daily by comparison with the readings of a mercury barometer. The continuous records of pressure thus obtained are valuable in showing the march of pressure, the extremes, and how the pressure is varying at any time. The *barometric tendency*, meaning the change in the pressure during the three hours preceding an observation, is of importance in forecasting.

Variation of pressure with height.—As we rise above sea level, we get above some of the weight of the air, and the

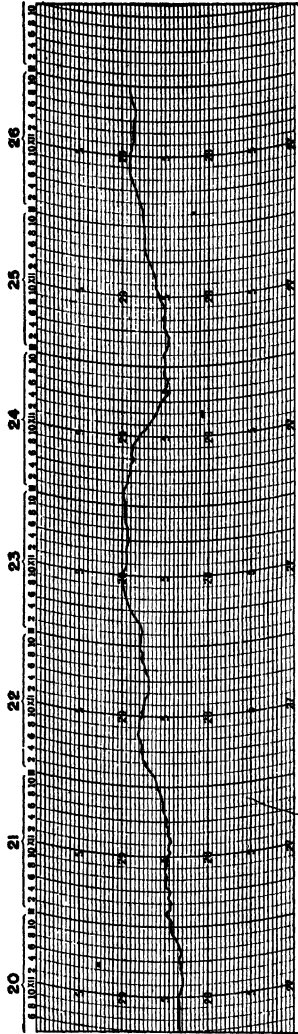

Fig. 12. Barograph Record at Lincoln, Nebraska, Elevation 1,189 Feet, September 20-26, 1931. A light thunderstorm occurred at 7:30 P.M., September 24th.

pressure falls, rather rapidly at first in the dense lower air, and then more slowly as the air becomes thinner. As a first approximation, we may say that the pressure decreases $1/30$ th of its value at any given moderate elevation with an increase of 900 feet in height. Starting with a pressure of 30 inches at sea level, at 900 feet above sea level it will have fallen to 29 inches; during the next 900 foot rise, to 1800 feet elevation, it will have fallen $1/30$ th of 29 inches to 28.03 inches; continuing at this geometric ratio for each successive change of 900 feet. But the density and weight of the air depend upon its temperature and, to a lesser extent, upon the proportion of water vapor in it, and the force of gravity. Hence, no accurate correction for elevation can be made without a consideration of these factors, especially the temperature.

Reduction to sea level.—In studying the distribution of pressure over the earth, it is necessary, then, to take account of the differing elevations of the places at which the pressure was measured. In doing this, all readings are customarily “reduced to sea level.” For places above sea level this means adding to the station pressure an amount assumed to represent the weight of the air in a vertical column extending from the point of observation to sea level. Since no such column exists beneath an inland station, assumptions as to its temperature and density are fictitious, and the results are only approximations. The practice of the Weather Bureau is to assume that the temperature of this air column is the mean of the current temperature at the place of observation and the temperature 12 hours earlier. When the elevations are considerable, as in the Rocky Mountain region, the reductions thus made are subject to considerable error.

Instead of using sea level as a base, some higher elevation, say 10,000 feet, which would be above most observing stations, might be used. Such a procedure has some advantages in that we would be dealing with an actual mass of air about whose density something is known, but it has not

come into general use. The various corrections to be applied in reducing pressures to sea level, or conversely, in determining heights by the barometer, are published in detail in Smithsonian Meteorological Tables. By applying these corrections, the difference in elevation between two nearby places may be determined with considerable accuracy if simultaneous observations of pressure, temperature, and humidity are obtained at the two stations.

Altimeter.—The relation of pressure to elevation has long been used by travelers, explorers, and surveyors in making estimates of elevations and differences in elevation, and now has a wide application in connection with aviation. The *altimeter*, carried by all airplanes, is an aneroid barometer graduated to read directly in heights instead of pressures. For various reasons it is not a satisfactory instrument for determining the height of an airplane. The elevations indicated are necessarily based upon some fixed temperature of the air column and must be corrected by the pilot when temperatures are known or supposed to be markedly different from the assumed temperature. The instrument is subject to considerable lag in its indications, and hence on a rapid descent indicates too great elevations. Finally, when an aviator begins a journey, he sets his altimeter according to the pressure at the time and place of starting, but the pressure differs widely from time to time at the same place, often enough to indicate differences of several hundred feet in elevation within a few hours, and also differs from place to place. Hence, as the time since the instrument was set increases, and as the aviator gets farther from the place where it was set, the probability of serious error in the indications of his altimeter increases. Obviously it is wise to check his instrument with ground readings as often as possible and to obtain from a weather map an estimate of the probable pressure at his destination at the time of his expected arrival.

Results of pressure observations.—Pressure observations began in Italy about the middle of the 17th century and

have been carried on more or less continuously in various parts of the world from that time to the present. Especially during the past 100 years, observations have been numerous and widely distributed. Yearly, monthly, daily, and hourly normals have thus been established, more or less definitely, throughout the world. The normal annual pressure is found to differ in different parts of the world and the monthly normals at any one place change with the seasons. Outside the tropics, there are also comparatively large irregular variations from day to day, independent of seasonal changes, but more marked in winter than in summer.

Diurnal variations.—Finally, there are regular daily variations of small amounts, resulting in two maxima and two minima each day. The maxima occur about 10 A.M. and 10 P.M., and the minima about 4 A.M. and 4 P.M., varying somewhat with the season. These diurnal variations are greatest in equatorial regions, where they amount to about 0.1 inch, and grow steadily less toward the poles. In higher latitudes they are partially masked by the irregular variations and may not be apparent except in the averages of a long period. No complete physical explanation of these daily changes has yet been made, but they appear to be long atmospheric waves, which move around the earth about 2 hours in advance of the sun and are in a complex way the result of daily changes in temperature.

Wind Observations

Wind is air which is in approximately horizontal motion. Vertical movements in the air are commonly called currents. Winds are of fundamental importance in making our weather what it is. In the first place, the motion itself is a weather factor of importance—a quiet winter's day is pleasant, a windy day is disagreeable. In the second place, the physical condition of the air is largely a function of its source and its movement. Winds become moist when moving over large water areas, and they carry this moisture to the land. Air becomes cold over frozen or snow-covered

regions and moves, as wind, to warmer regions. Similarly, warm air is transported to normally cold regions. To describe the movement itself, without reference to the condition of the moving air, two facts about the wind must be observed, namely, its direction and its velocity of motion.

Wind direction.—*Wind vanes* have been in use since ancient times as indicators of the direction of the wind. A wind is named for the direction from which it comes, the direction toward which the arrow of the wind vane points. Winds are said to *veer* when they change in a clockwise direction, that is, from north to east to south to west, and are said to *back*, when they change in the opposite order.

In order to secure a sensitiveness of response and at the same time a comparative steadiness in gusty winds, the Weather Bureau uses a wind vane about 30 inches in length, mounted on roller bearings, and having a tail of 2 pieces, each 8 inches wide and 12 inches long, making an angle of 22° with each other. An automatic record of the wind direction at intervals of 1 minute is obtained by attaching a cam collar to this vane and connecting it by electrical circuits to a recording device actuated by clockwork. The recording instrument in use by the Weather Bureau is called a *meteorograph* or *triple register*. It records not only wind direction but also wind velocity, sunshine, and rainfall, as will be noted later. Hence the name triple register, since it records three weather elements. Eight directions are registered on this instrument; the four cardinal points of the compass, north, east, south, and west, and the four intermediate directions, north-east, south-east, south-west, and north-west. Other devices are in use, called *anemoscopes*, which give a continuous record of the wind direction.

Wind velocity.—Moving air exerts a force or pressure against objects in its path, and that force is proportional to the square of its velocity. This may be expressed by the equation: $P = KV^2$, where P is the pressure exerted by the wind, V is its velocity, and the value of K depends upon the units used. If pressure is expressed in pounds per square

foot, and velocity in miles per hour, then $P = .004 V^2$, approximately, for a flat surface normal to the wind, where pressure includes also the suction on the rear of the surface. By reason of this force exerted by the wind, its velocity can be estimated without instruments by its effect on surrounding objects. For this purpose a scale has been developed, known as the *Beaufort scale*. Originally developed at sea and expressing the effect of the wind on sails, it has been adapted for use on land, and is shown on the following page, as used by the United States Weather Bureau.

For a more accurate measurement of wind velocity several types of *anemometers* have been developed. A *deflection anemometer* consists of a board hinged at the top and swinging in the wind, having an attached arc to indicate the angular amount of its deflection from the vertical. From this deflection the velocity may be calculated. A wind vane on the same axis keeps the board broadside to the wind. A *pressure tube anemometer* consists of a U-tube containing a liquid and having one open end exposed to the wind. The difference in level of the liquid in the two parts of the tube is a measure of the pressure of the wind and hence of its velocity.

Robinson cup anemometer.—For meteorological purposes the most convenient and reliable anemometer yet developed appears to be the Robinson cup anemometer. In this type of instrument a set of cups is mounted on a vertical axis, attached to a spindle which actuates a dial. As the cups revolve in the wind, distances are indicated on the dial either in miles or in meters. In making such an instrument it is necessary to use a fixed ratio between the velocity of the cups and the distance indicated on the dial. In the 4-cup type used by the Weather Bureau the ratio is 1 to 3; that is, the dials indicate 1 mile when the cups have moved only $\frac{1}{3}$ of a mile. In fact, however, the ratio of the velocity of the cups to the true velocity of the wind varies, making the readings of the anemometer too small at low velocities and too great at high velocities. This has been

BEAUFORT WIND SCALE

<i>Beaufort number</i>	<i>Explanatory titles</i>	<i>Specifications for use on land</i>	<i>Miles per hour</i>	<i>Terms used in Weather Bureau forecasts</i>
0	Calm	Smoke rises vertically	Less than 1.	Light
1	Light air	Direction of wind shown by smoke drift, but not by wind vanes.	1-3	
2	Slight breeze	Wind felt on face; leaves rustle; ordinary vane moved by wind.	4-7	
3	Gentle breeze	Leaves and small twigs in constant motion; wind extends light flag.	8-12	Gentle
4	Moderate breeze	Raises dust and loose paper; small branches are moved.	13-18	Moderate
5	Fresh breeze	Small trees in leaf begin to sway; crested wavelets form on inland water.	19-24	Fresh
6	Strong breeze	Large branches in motion; whistling heard in telegraph wires; umbrellas used with difficulty.	25-31	Strong
7	High wind	Whole trees in motion; inconvenience felt in walking against wind.	32-38	Gale
8	Gale	Breaks twigs off trees; generally impedes progress.	39-46	
9	Strong gale	Slight structural damage occurs (chimney pots and slate removed).	47-54	
10	Whole gale	Seldom experienced inland; trees uprooted; considerable damage occurs.	55-63	Whole gale
11	Storm	Very rarely experienced; accompanied by widespread damage.	64-75	
12	Hurricane		Above 75	Hurricane

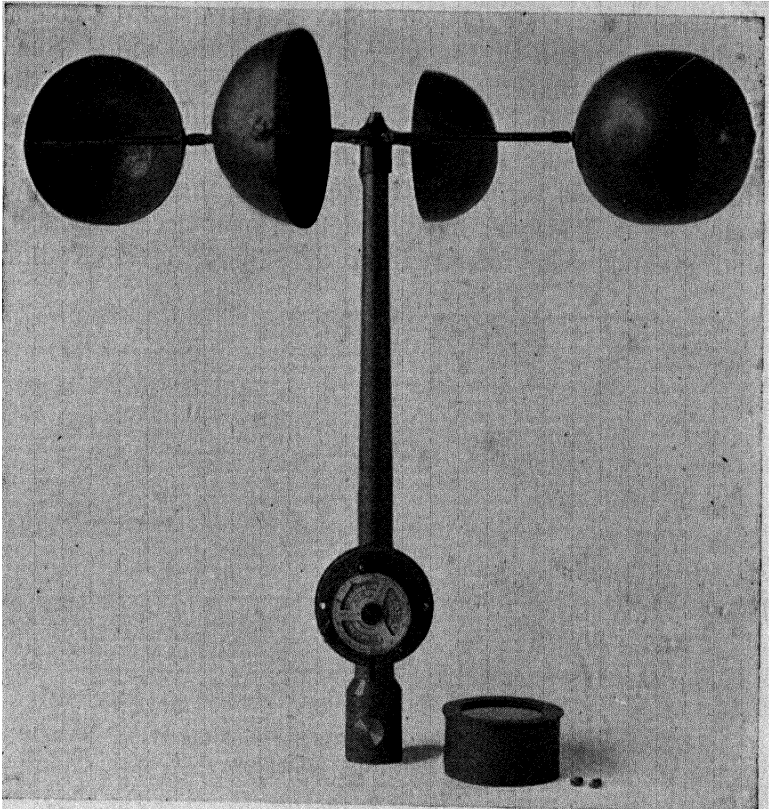

Fig. 13. Robinson 4-Cup Anemometer. Dial cover removed. *Courtesy, U. S. Weather Bureau, Washington, D. C.*

determined by careful calibration of such anemometers in a wind tunnel, where the movement of the air is known accurately by other means. The corrections so determined are applied to the indicated velocities before publication, and the published velocities are as nearly true velocities as it is practicable to obtain at present. By fitting the dial with posts which press against a spring and thus close an electric circuit for each mile, an automatic record of the wind movement is obtained on the meteorograph on the same sheet with the record of the direction.

Structure of winds.—The record made by a cup anemometer gives the time between successive mile marks, but

a pressure tube anemometer may be arranged to give a continuous graph of the fluctuations of the wind. Such records show that the flow of air near the surface of the earth is never steady. It is not a streamline flow but a movement in successive gusts and lulls of a few seconds' duration. This *turbulence* is greater, the higher the wind velocity; it is greater over land than over ocean surfaces, and greater over forests than over bare, level ground.

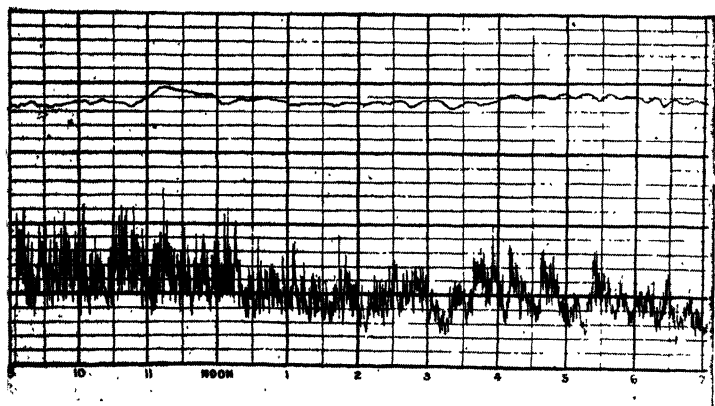

Fig. 14. Anemoscope Record, Showing Gustiness of the Wind. Courtesy, U. S. Weather Bureau, Washington, D. C.

Evidently, the turbulent motion is caused in part at least by surface irregularities and friction. Friction at the earth's surface induces gustiness by checking the flow of the lowest layer, letting the layers above it break over it like the waves along a sloping seacoast. Surface obstacles turn the air out of its course and into numerous cross currents. Eddies around buildings and through city streets are familiar examples of turbulent motion, but every tree and shrub and every little irregularity of the land causes similar eddies in relation to its size, changing both the velocity and the direction of the wind in its vicinity. The effect of such obstructions extends to five or six times their dimensions. These effects are, therefore, local and confined to the air near the earth's surface, unless other forces aid

in causing unsteady motion. One other factor of great importance in causing turbulence is the rate of change of temperature with elevation. How this may add to the gustiness of the wind and extend it to greater elevations will be discussed later.

Effect of altitude.—The average velocity of the wind increases with altitude up to about 1,600 feet (500 m.), From that point it often decreases to a second minimum at about 3,200 feet (1 km.). There is a marked increase in the first 100 feet (30 m.). In general the velocity at a height of 33 feet is about twice that at 1½ feet, and the velocity at 100 feet is 1.2 times that at 33 feet. This reduced velocity near the surface is evidence of the “frictional drag” of the earth. Notwithstanding the increased velocity, there is less turbulence as we rise into the free air, but some effects of surface eddies are felt to heights of 6,000 to 9,000 feet (1,800–2,700 m.). Turbulence also sometimes originates in the upper air by the contact of winds of different directions or velocities and different densities.

Exposure of wind vane and anemometer.—Considering the effects of surface turbulence and surface drag, it is evident that, in order to get records truly representative of the general conditions in a region, the place of exposure of the wind vane and anemometer must be carefully selected. The instruments should be placed where they are as free as possible from interference by local irregularities, that is, as far as possible from adjacent high objects and as much as possible above them. Often they are placed on the roof of a building at a distance from other buildings of comparable height, and are raised on steel supports 15 to 25 feet above the roof, thus making the elevation above ground 50 feet or more, and sometimes 200 or 300 feet. Valleys, even shallow ones, affect the direction at the surface markedly, and the velocity to a less extent, and the wind records obtained in mountainous regions are seldom representative of large areas.

Results of wind observations.—The records obtained by continued observations of the wind afford valuable information which may be summarized in various ways. Official records in the United States give the prevailing direction and the average velocity for each day, month, and year, and the monthly and annual normals; also the maximum velocities by months, and the number of days when velocities of 32 miles per hour or more occurred. The latter gives the number of high winds; see No. 7 on the Beaufort scale. There are also calculated the percentages of the time the wind blew from each of the eight directions recorded by the meteorograph, and the percentages of the total movement from each direction. Wind data may be graphically presented by means of wind roses of which Fig. 15 is a simple example, and in which the relative length

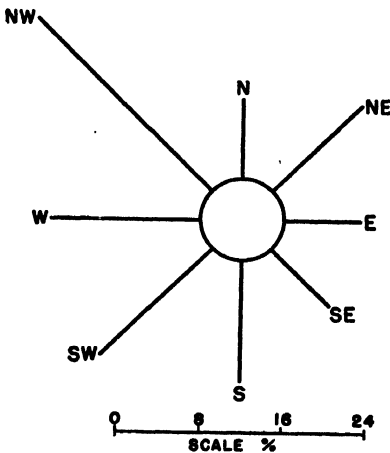

Fig. 15. Wind Rose for New York City. Average annual percentage of winds from eight directions.

of the radiating lines indicates the relative frequency of the winds from the different directions.

Annual variations.—The accumulated observations show that there is an annual change in both the direction and the velocity of the wind, in most parts of the world. The velocity is greater on the average in winter and spring than in summer and autumn. The reason for this is the greater contrast in temperature between high and low lati-

tudes in the winter and spring seasons, as will be noted later. Usually March is the month of highest average velocity, and August the month of lowest, but in a large part of the Mississippi and Missouri valleys, April is windier than March. In Rocky Mountain and Pacific

Coast regions and in the vicinity of the Great Lakes there is considerable local variation in the months of highest and lowest average velocity. The prevailing direction of the wind also frequently changes with the seasons, owing to changing temperature contrasts between land and ocean areas.

Diurnal variations.—The velocity of the wind is generally greater by day than by night over land surfaces, especially in summer and on clear days. The highest average occurs from 1 to 3 P.M., and the lowest about sunrise. These diurnal variations are caused by the heating and rising of the surface air by day and the descent of faster-moving air from aloft. This explanation is confirmed by the fact that at sea, where the surface does not become heated, there is little difference between day and night velocities. The conditions under which vertical interchanges of air take place are discussed in Chapter IV. In most coastal regions there is a daily change in wind direction which is considered later.

Irregular variations.—Although the annual and daily variations of the wind movement recur with more or less regularity, they are subject to continual interruption by irregular changes due to special causes. Sometimes these erratic variations occur as *squalls*—sudden marked increases in velocity, like gusts, but lasting longer—and sometimes as sustained and more gradual changes in velocity.

Summary

The temperature of the air is measured by thermometers. Meteorological thermometers are glass tubes, containing either mercury or alcohol. They respond to temperature changes by corresponding changes in the length of the liquid column. The temperatures of melting ice and of boiling water are designated 32° and 212°, respectively, on the Fahrenheit scale; 0° and 100° on the centigrade scale; 273° and 373° on the absolute scale.

Registering thermometers, set to the current temperature

at regular intervals of time, are used to ascertain the highest and lowest temperatures occurring between the intervals. Continuous records of air temperature are obtained by the use of thermographs. To make certain that the thermometer or thermograph assumes the temperature of the air, it is screened from direct and reflected heat as much as possible by being exposed in a shelter with louvered sides and open to the wind in all directions. A knowledge of temperature averages, extremes, annual and irregular variations is essential in describing the weather and climate of a region.

The pressure of the air is continuously variable, and its variations bear a close and causal relation to the other weather elements. A mercury barometer measures the pressure of the air in terms of the length of the column of mercury supported by the air pressure. The length is expressed in inches or millimeters; or the force corresponding to the weight of the mercury column is expressed directly in millibars. A mercury barometer must be corrected for the temperature of the mercury, the value of gravity, and instrumental errors. An aneroid barometer measures the pressure of the air directly by the compressive effect upon an elastic metal box. A barograph is an aneroid barometer that writes a continuous record of air pressure upon a drum rotated by a clock.

Altimeters are aneroid barometers graduated to read in elevations instead of pressures. The pressure of the air decreases with increase of elevation above the surface of the earth, roughly at the geometric ratio of 1/30th of its value at any elevation for each 900 feet increase in elevation. For a more accurate relation of pressure to elevation, variations in the temperature and humidity of the air and in the force of gravity must be considered. Barometer readings are "reduced to sea level" by calculating what the pressure at a given station of known elevation would be if it were at sea level. Records show that there are geographical differences in the average pressure and that there

are seasonal, diurnal, and irregular changes in pressure.

The direction and velocity of air movement are important elements of weather. Wind vanes and anemometers are used in observing and recording these elements. Both direction and velocity of wind have a great, but irregular, variability from day to day, and also show many fluctuations in periods of a few seconds. The gustiness and turbulence evidenced by these minor variations are due in large part to irregularities of the surface over which they are moving, but in part to other causes. Turbulence is greater over land than over oceans and increases with velocity but decreases with elevation, although the velocity increases on the average up to about 1,600 feet.

Problems

1. Express the following Fahrenheit temperatures in the centigrade scale: 86° ; 44° ; 23° ; -13° .
2. Change the following centigrade temperatures to Fahrenheit: 35° ; 23° ; 10° ; -10° ; -20° .
3. The following barometer readings are given in inches: 28.75; 29.54; 30.15; 30.36. Express them in millimeters and in millibars.
4. What is the approximate barometric pressure in inches and in millibars at the following elevations: 1,800 feet; 2,700 feet; 1 mile?
5. What is the pressure in pounds per square inch at the elevations in problem 4? (A cubic inch of mercury weighs 0.49 pound.)
6. Calculate in round numbers the total weight (pressure at the surface) of the earth's atmosphere.
7. From data given in Table 5, Appendix III, draw graphs of the annual march of temperature at Honolulu, London, Moscow, Freetown, Melbourne, and note variations in annual range and in retardation of maximum and minimum. Compare with Fig. 8.
8. What pressure does the wind exert against a wall, 60 by 140 feet, if it is blowing 12 miles per hour? 24 miles per hour? 48 miles per hour?

CHAPTER III

Observing Moisture, Sunshine, Visibility, and Upper Air Conditions

Humidity Observations

Some of the moving molecules at the surface of a liquid are continually escaping and entering the air as gaseous molecules, thereby reducing the volume of the liquid. For any given surface of a given liquid, such as water, the number which escapes depends solely upon the speed with which they are moving, that is, upon the temperature of the surface of the liquid. Raising the temperature increases the velocity of the molecules and the rate at which they break free from the liquid surface. It is thus that gaseous water, commonly called water vapor, enters the air from water surfaces and from soil and plants. This process is called *evaporation*, and it occurs not only from liquid surfaces but from some solids, ice for instance. In breaking away from the attraction of the other molecules, the escaping molecules do work, use energy, at the expense of the remaining liquid which is thereby cooled. The heat energy so lost to the liquid does not warm the gas but is used solely in effecting the change from liquid to gas, and is called *latent heat of vaporization*.

Vapor pressure and saturated vapor.—When water vapor thus escapes into space and mixes with the other gases of the air, it exerts a pressure in all directions, as do the other gases. This is known in meteorology as the *vapor pressure* of the air. It is independent of the pressure of the other gases, exerting the same pressure when mixed with the other

gases of the air as it would alone. The force exerted depends upon the concentration of the vapor, that is, upon the number of molecules per unit volume. It is commonly expressed in the same units as the total air pressure, that is, either in millibars, or in inches or millimeters of mercury, referring to the length of the barometer column which the partial pressure due to the water vapor would sustain.

Considering an open water surface, we find not only an escape of molecules from the liquid to the air, but also some return of the gaseous molecules to the liquid. At first the number escaping will be greater than the number returning, and we say that evaporation is occurring. But as the number of molecules of vapor in the air increases, there is an increase in the vapor pressure and in the number returning to the liquid, until a point is reached when the number returning is just equal to the number escaping. The net evaporation is then zero, and the vapor is said to be saturated; that is, the space can hold no more water vapor under the existing conditions. If we now raise the temperature of the air, the tendency of the water vapor to return to a liquid state is decreased, and we must add more vapor to keep the space saturated. At any given temperature, the saturation vapor pressure has a definite, fixed value, but the value changes rapidly with change of temperature, as may be seen in Table I, page 51. For example: at 0°F. the saturated vapor pressure is 0.038 inch; at 50°F., 0.360; and at 100°F., 1.916 inches. These values have been determined by careful experiment.

Dew point and condensation.—Suppose air at 70°F. has enough water vapor in it to exert a pressure of 0.360 inch. Evidently this does not produce saturation, for when water vapor has a temperature of 70°, its saturation pressure is 0.732 inch (see Table I). If the air, including the water vapor, be cooled to 60°, without any change in the vapor content, the vapor still exerts a pressure of 0.360 inch, and the space it occupies is still unsaturated. If it be cooled to 50°, saturation is reached, since 0.360 inch is the satu-

ration vapor pressure at 50°F. The temperature at which saturation occurs is called the *dew point*. Air having a vapor pressure of 0.360 inch has a dew point of 50° whatever the actual temperature of the air (disregarding the effect of differences in barometric pressure, to be noted later). The dew point of a mass of air is determined by its vapor pressure, and is independent of its temperature.

If the vapor is cooled below its dew point, some of it becomes liquid. The process of changing from gas to liquid is called *condensation*. As heat is transformed into work in the process of evaporation, resulting in cooling the liquid, so, in condensation, an equal amount of energy is transformed into heat, called *latent heat of condensation*, which results in adding heat to the air. Ordinarily condensation begins as soon as the dew point is passed, but under certain conditions when the air contains only very small or insoluble dust particles, condensation is delayed until the vapor is cooled considerably below its dew point. In that condition the air is said to be *supersaturated*.

Absolute humidity.—In dealing with the moisture in the air, one quantity to be measured is the actual mass of water vapor in a given sample of air. It may be expressed, for example, as the number of grains' weight in a cubic foot of air, or the number of grams in a cubic centimeter. We thus obtain the *absolute humidity*, which is defined as the mass of water vapor per unit volume of air. (Mass means quantity of matter. It is expressed in the same units as weight under standard gravity.) The mass of a given volume of gas is proportional to the pressure of the gas, at constant temperature. Hence, the vapor pressure expressed in barometric units is an indirect measure of the absolute humidity. This is the usual and most convenient method of obtaining and recording the quantity of moisture in the air. Since the dew point also depends upon the amount of moisture present, the dew point, likewise, gives an indirect indication of the absolute humidity.

It is evident that absolute humidity is increased when

water vapor is added to the air, as, for example, by evaporation, and decreased when vapor is removed, as by precipitation. The absolute humidity may also be changed without the addition or subtraction of water vapor, in the following manner: take a cubic foot of air containing a certain number of molecules of water vapor at the surface of the earth, and raise it to a considerable height above the surface; it expands, becoming more than a cubic foot, and the same quantity of water vapor, and of other gases, is distributed through a larger volume. Hence the mass of water vapor per cubic foot is less than before; that is, the absolute humidity is less. Similarly, when air is compressed, its absolute humidity increases.

Relative humidity.—A matter of more general interest as an element of the weather than the absolute humidity is the *relative humidity*, which may be defined as the ratio of the actual quantity of water vapor in a given volume of air to the possible quantity in the same space at the same temperature. The actual quantity is the absolute humidity, and the possible quantity is the amount at saturation. Hence the relative humidity equals the absolute humidity of the given sample of air, divided by what would be its absolute humidity if it were saturated. Or, since vapor pressure is proportional to absolute humidity, relative humidity equals the actual vapor pressure divided by the saturation pressure. Let f stand for relative humidity, e for vapor pressure, and e_s for saturation vapor pressure; then $f = e/e_s$.

Relative humidity is a ratio between two masses or two pressures, and is always expressed as a percentage. The percentage is never zero under natural conditions, since even the driest desert air contains some moisture. It is occasionally 100 per cent, meaning complete saturation, as often occurs in a dense fog. Like the absolute humidity, the relative humidity may be increased by the addition of water vapor and decreased by its removal, but without such change in water content, the relative humidity of a given

space is quite directly governed by the temperature of the vapor, since temperature governs the saturation vapor pressure. Warming the vapor increases its saturation pressure, which is the divisor in the above definition, and therefore decreases the relative humidity. Cooling the vapor similarly increases the relative humidity.

Specific humidity.—Another measure of humidity which has recently come into general use in meteorological studies, especially in connection with upper air observations, is called *specific humidity*, defined as the weight of water vapor per unit weight of air (including the water vapor). Notice that absolute humidity is the relation of the weight of vapor to the *volume* occupied, and specific humidity is the relation of weight of vapor to *weight* of air. Again, since the pressures exerted by gases are proportional to their masses, specific humidity may be obtained by dividing the partial pressure due to the water vapor by the total pressure of the air. Thus we have the equations:

$$\text{Sp. Hum. } (q) = \frac{\text{Weight of vapor}}{\text{Weight of air}} = \frac{\text{pressure of vapor } (e)}{\text{total air pressure } (p)} = \frac{Ke}{p}$$

where e and p are expressed in barometric units, such as millibars or inches, and K is a constant depending on the unit of specific humidity. Specific humidity is usually expressed in grams of water vapor per kilogram of air, and the equation becomes: $q = 622 e/p$. When a quantity of air expands or is compressed, the total pressure and the vapor pressure change in the same ratio, so that the value of e/p remains the same. Hence the specific humidity is constant under these conditions; it does not change unless water is added or removed.

Measurement of humidity.—The dew point may be determined directly by a simple laboratory experiment. If water be placed in a thin-walled, brightly-polished silver cup and kept well stirred, the temperature of the liquid and the cup will be the same. If sufficient ice be added to cool the water and the cup below the dew point of the surround-

ing air, the outer polished surface of the cup will be visibly clouded by beads of water. The temperature of the water (thoroughly stirred) at the time this clouding begins is the dew point of the surrounding air to a close approximation. An instrument of this kind is called a *dew-point hygrometer*.

The absolute humidity may be measured by passing a known volume of air through a chemical which absorbs the moisture, and noting the resulting increase in weight of the absorbing substance. By more elaborate instrumental means, the saturation vapor pressures at different temperatures have been experimentally determined with great care. From such laboratory determinations and from the known physical relations between the various humidity factors, tables which simplify the procedure in obtaining humidity values in the actual practice of making weather observations have been prepared and published. The authoritative publication of such tables in this country is in *Smithsonian Meteorological Tables*, published by the Smithsonian Institution, and in tables published by the United States Weather Bureau.

Psychrometers.—In meteorological practice a psychrometer is commonly used for humidity measurements. The whirled psychrometer used by the Weather Bureau consists of two mercury thermometers with cylindrical bulbs, mounted vertically upon a frame which can be turned rapidly by a hand crank. The two thermometers are alike, but one has a thin piece of clean muslin tied around the bulb. This bulb is dipped in water, and the two are whirled. After a minute or two of whirling the two thermometers are read. The reading of the thermometer with the dry bulb is the current temperature of the air; the wet-bulb thermometer will ordinarily be found to have a lower reading. The whirling is repeated until no further reduction in the reading of the wet-bulb thermometer can be obtained. The cooling of the mercury is due to the evaporation of the moisture around it. When it is thus whirled at a moderate

speed, the cooling is directly proportional to the dryness (vapor pressure) of the air. The difference in temperature between the dry-bulb and the wet-bulb thermometers, therefore, gives a measure of the moisture of the air. Given this difference, which is called the depression of the wet bulb, the dew point, vapor pressure, and relative humidity can be read from the *Smithsonian Meteorological Tables*. A *sling psychrometer* is a similar instrument ex-

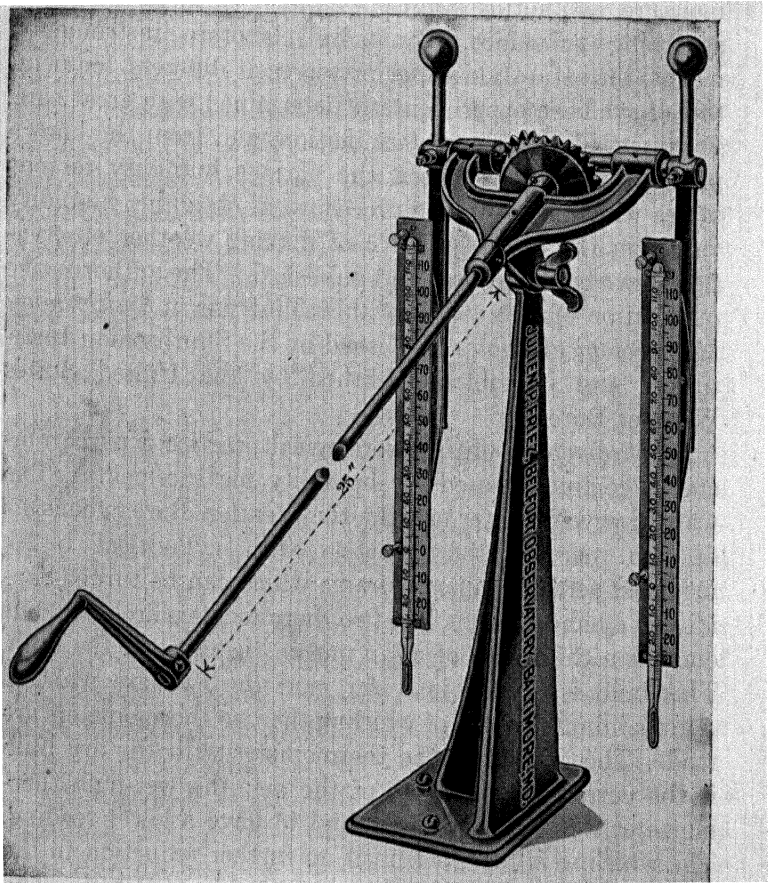

Fig. 16. Whirled Psychrometer. For humidity observations a wet muslin sleeve is fitted over the bulb of one of the thermometers, which are then whirled rapidly by turning the crank. Courtesy, J. P. Friez & Sons, Baltimore, Md.

TABLE I
**SATURATION VAPOR PRESSURE IN INCHES OF MERCURY AND TEMPERATURE OF DEW POINT
 IN DEGREES FAHRENHEIT**
 (Barometric pressure, 30.00 inches)

Air Temp. °F.	Saturation Vapor Pressure In.	Depression of Wet-bulb Thermometer																										
		1	2	3	4	6	8	10	12	14	16	18	20	25	30													
0	.088	-7	-20																									
5	.049	-1	-9	-24																								
10	.063	5	-2	-10	-27																							
15	.081	11	6	0	-9																							
20	.103	16	12	8	2	-21																						
25	.130	22	19	15	10	-3	-15																					
30	.164	27	25	21	18	8	-7	-11																				
35	.203	33	30	28	25	17	7	7	-14																			
40	.247	38	35	33	30	25	25	18	7	-14																		
45	.298	43	41	38	36	31	31	25	18	7	-14																	
50	.360	48	46	44	42	37	37	32	26	18	8	-13																
55	.432	53	51	50	48	43	43	38	33	27	20	9	-12															
60	.517	58	57	55	53	49	49	45	40	35	29	21	11	-8														
65	.616	63	62	60	59	55	55	51	47	42	37	31	24	14														
70	.732	69	67	65	64	61	61	57	53	49	44	39	33	26	-11													
75	.866	74	72	71	69	66	66	63	59	55	51	47	42	36	15													
80	1.022	79	77	76	74	72	72	68	65	62	58	54	50	44	28													
85	1.201	84	82	81	80	77	77	74	71	68	64	61	57	52	39													
90	1.408	89	87	86	85	82	82	79	76	73	70	67	63	59	48													
95	1.645	94	93	91	90	87	87	85	82	79	76	73	70	66	56													
100	1.916	99	98	96	95	93	93	90	87	85	82	79	76	72	63													

TABLE II
RELATIVE HUMIDITY, PER CENT
 (Barometric pressure, 30.00 inches)

Air Temp. °F.	Depression of Wet-bulb Thermometer													
	1	2	3	4	6	8	10	12	14	16	18	20	25	30
0	67													
5	73	33	1											
10	78	46	20	13										
15	82	56	34	29										
20	85	64	46	40	12									
25	87	74	55	49	25	1								
30	89	78	62	56	36	16								
35	91	81	72	63	45	27	10							
40	92	83	75	68	52	37	22	7						
45	93	86	78	71	57	44	31	18	6					
50	93	87	80	74	61	49	38	27	16	5				
55	94	88	82	76	65	54	43	33	23	14	5			
60	94	89	83	78	68	58	48	39	30	21	13	5		
65	95	90	85	80	70	61	52	44	35	27	20	12	3	
70	95	90	86	81	72	64	55	48	40	33	25	19	9	
75	96	91	86	82	74	66	58	51	44	37	30	24	8	
80	96	91	87	83	75	68	61	54	47	41	35	29	15	3
85	96	92	88	84	76	70	63	56	50	44	38	32	20	8
90	96	92	89	85	78	71	65	58	52	47	41	36	24	13
95	96	93	89	86	79	72	66	60	54	49	44	38	27	17
100	96	93	89	86	80	73	63	62	56	51	46	41	30	21

cept that the two thermometers are mounted together on a metal back and are whirled by hand by means of an attached cord or chain. The *aspiration psychrometer* has the two thermometers inclosed in a tube through which air is drawn by a fan.

In Table I, condensed from *Psychrometric Tables of the United States Weather Bureau*, will be found the saturation vapor pressures for various temperatures, and also a table for obtaining dew points from psychrometric observations. Differences between the readings of the wet-bulb and dry-bulb thermometers are given at the head of the columns 1 to 30. The dew point corresponding to a given air temperature and a given depression of the wet-bulb thermometer is found in the body of the table. For example, when the temperature is 50° and the depression is 6° , the dew point is 37° ; also when the temperature is 65° and the depression 14° , the dew point is 37° . Similarly, Table II gives the relative humidity in terms of the air temperature and the cooling of the wet thermometer. It will be seen, for example, that the relative humidity is 55 per cent when the temperature is 20° and the depression 3° and again with a temperature of 70° and a depression of 10° .

Hygrometers.—The *hair hygrometer* is an instrument which gives a direct reading of the relative humidity. The oils are removed from a strand of human hair, which is then attached so that its changes in length actuate a pen moving over a dial. In the *hair hygograph* the pen moves over a cylinder and makes a continuous record of the relative humidity. The hairs change their length in proportion to the changes in relative humidity, getting longer as the humidity increases. In using psychrometers or hygrometers it must be remembered that maintaining an active movement of air past the instrument is essential to obtaining a representative reading.

Humidity records.—From readings of the whirled psychrometer, the Weather Bureau obtains and records, three times each day, the dew point, relative humidity, and vapor

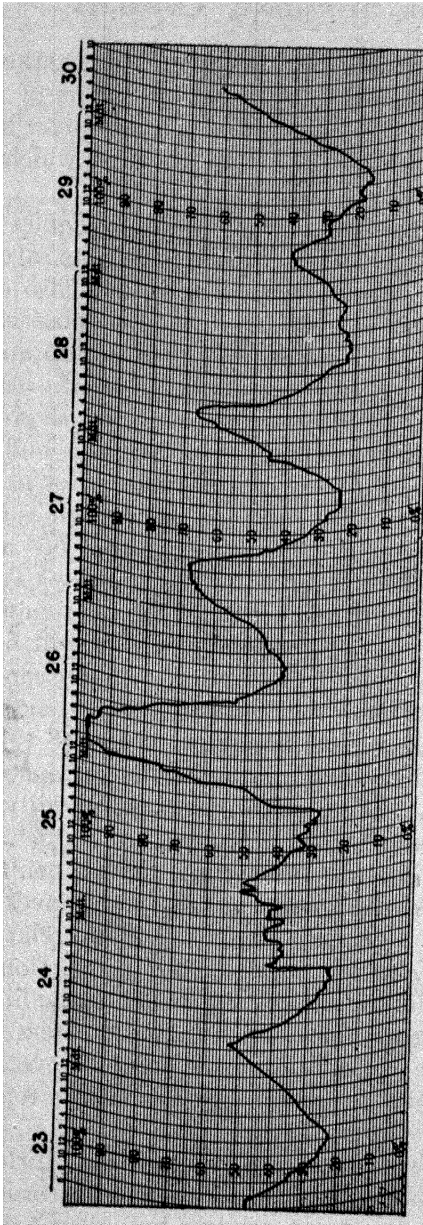

Fig. 17. Hygograph Record Showing Diurnal and Irregular Variations in Relative Humidity at Lincoln, Nebraska, July 23-30, 1934. Occasional showers fell from 6 P.M. of the 24th to 1 A.M. of the 26th.

pressure. Many stations also obtain a continuous record of the relative humidity by means of the hair hygograph. The relative humidity shows both a diurnal and an annual variation; it is, on the average, greatest during the coolest part of the day and of the year, and least during the warmest portions. The vapor pressure and the absolute humidity have the opposite variations, increasing as the temperature increases.

Vapor-pressure and dew-point data are used in many meteorological studies, in the forecasting of weather conditions, and in many practical applications. Variations in relative humidity have a direct effect on human comfort and health, as will be noted later, and also affect many of man's occupations. For example, maintenance of the correct relative humidity is important in keeping fruits, eggs, and other perishable products in good condition in cold storage. Such products as silks and cigars can best be manufactured where the humidity is rather high, but sun-dried fruits require a dry atmosphere.

Evaporation Observations

Evaporation is of primary interest in meteorology as the source of the water vapor of the air, but it is also an important meteorological factor in itself, especially in its effect on soil moisture and plant growth.

Amount of evaporation.—The depth of water evaporated from a given water surface in a given time depends in the main upon the following factors:

1. **Temperature of the water.**—The higher the temperature of the water, the more rapid is the evaporation. It has been noted that saturation vapor pressure increases rapidly with temperature; evaporation increases at about the same rate.

2. **Relative humidity of the air.**—The nearer the air above the water approaches saturation, the less rapid will be the net loss from the water.

3. **Wind movement.**—Wind removes the moist air in di-

rect contact with the water and replaces it with drier air. Hence, evaporation increases with wind velocity.

4. Salinity.—The presence of dissolved minerals or salts in the water retards evaporation. Evaporation from sea water is about five per cent less than from fresh water, other conditions being the same.

Measurement of evaporation.—The evaporation from a water surface is often measured by use of a shallow circular pan, 6 to 10 feet in diameter, and 10 to 12 inches deep. This is filled with water nearly to the top and the decrease in depth carefully measured every 24 hours by a hook gage. The loss of water from such a pan will depend not only on the general factors mentioned in the preceding paragraph but also upon the size of the pan and its method of exposure, whether it is buried in the ground, resting on the surface of the ground, or raised above it with air circulating beneath. This is largely because these factors affect the

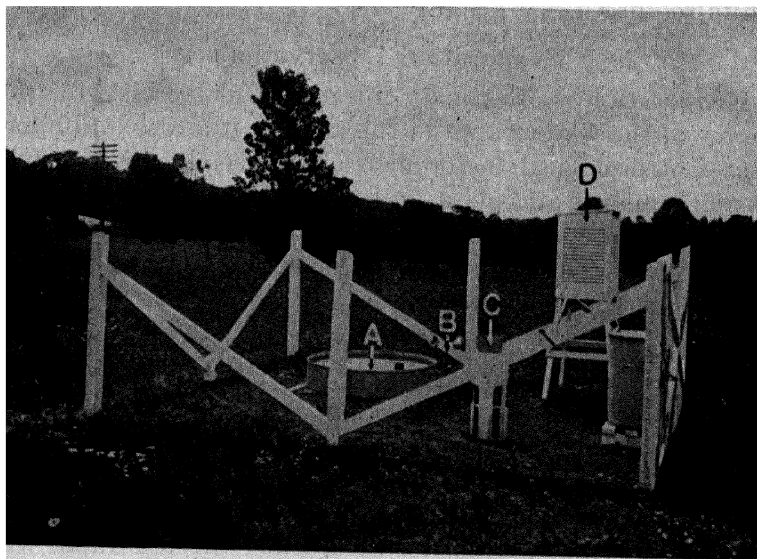

Fig. 18. Class A Evaporation Station, Showing Evaporation Pan, A; Anemometer, B; 8-Inch Rain Gage, C; and Instrument Shelter, D. Courtesy, U. S. Weather Bureau, Washington, D. C.

temperature of the water. The evaporation from such a pan is not the same as from a lake under similar weather conditions, partly because the lake water takes on a different temperature, and partly because the moisture content of the air is increased in moving across a considerable body of water. The air has a higher humidity toward the leeward side of the lake than on the windward side.

Evaporation from plant and soil surfaces is great, but the rate varies considerably. In the case of the soil, evaporation is influenced by the texture and tilth of the soil and by its water content. In the case of plants it varies for each species and, in the same species, with the leaf surface and the growing condition of the individual plant. No very satisfactory formulas have been developed to connect the measured evaporation from a pan with the loss from larger bodies of water or from plants and soil, as the relations are very complex in all cases. However, records made in different localities, with the same kind of pan, similarly exposed, give valuable comparative results, showing the relative amounts of evaporation in different climates.

In the greater part of the western half of the United States, where precipitation is light, the annual evaporation from a water surface is greater than the annual rainfall. In parts of Arizona it has been found to be more than nine times the rainfall. In spite of difficulties in the application of evaporation data to specific problems, such data are of much practical value; for example, to hydraulic engineers, in the planning of storage reservoirs and irrigation systems, and to plant scientists, in the study of the relations of plants to their environment.

Cloud Observations

Clouds are condensed moisture, consisting of droplets of water or crystals of ice, having diameters varying from .001 to .004 inch. The particles, whether liquid or solid, tend to fall, not float, but as their individual masses are small, they fall very slowly, owing to the resistance offered by the air.

They are easily sustained and transported by air movements as small as one-tenth of a mile per hour.

Cloud classification.—Although clouds are prominent and often spectacular features of the sky in nearly all parts of the world, there seems to have been no attempt to name and classify them until an Englishman, Luke Howard, in 1803, suggested the classification which has become the basis of all later cloud nomenclature. Howard's system was based on the appearance of the clouds to the observer on the earth, but has been modified from time to time to conform to increasing knowledge of the physical processes in the formation of clouds of different types. The classification now in use throughout the world is known as the *international classification* and is sponsored by the International Meteorological Committee, representing the official meteorological services of the world. It was first published in 1895, revised in 1910, and again in 1930. The latest revision defines and describes ten types of clouds, retaining the three main type forms: cirrus, stratus, and cumulus, first named by Howard. The other names are derived by combinations of these three words and by the use of *alto*, meaning high, and *nimbus*, meaning rain cloud.

International cloud forms.—The ten forms now given official international names and descriptions are as follows (the abbreviations are also in international use):

1. *Cirrus* (Ci.).—Detached clouds of delicate and fibrous appearance, without shading, generally white in color, often of a silky appearance, of varied forms, such as tufts and feather-like plumes, and often arranged in bands. *Cirrus nothus*, or hybrid cirrus, is cirrus proceeding from a cumulonimbus and composed of the debris of the upper frozen parts of these clouds. This cloud was formerly called "false cirrus."¹

2. *Cirrocumulus* (Cicu.).—A cirriform layer or patch

¹ "Tonitro cirrus" (thunder cirrus) has been suggested, and used to some extent, for "false cirrus."



Fig. 19. Cirrus. Delicate cirrus, composed of irregularly arranged filaments oriented in various directions; shows at lower left a tendency to fuse together into cirrostratus. *Photo by H. Floreen.*

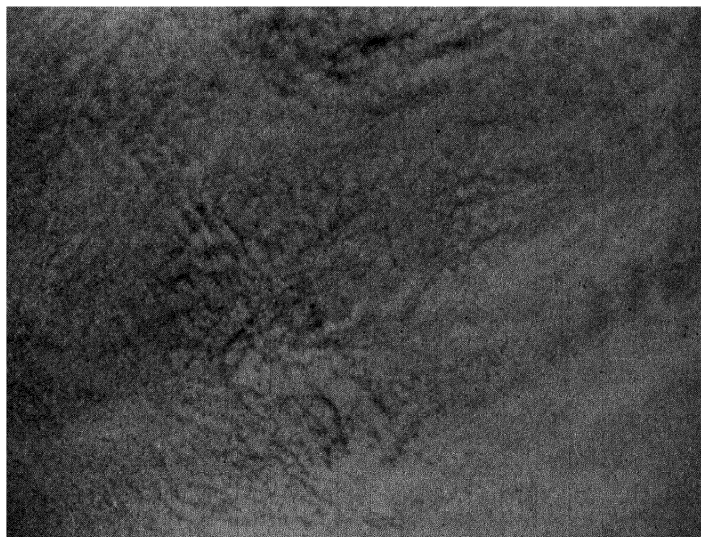

Fig. 20. Cirrocumulus. Closely packed, small, globular masses or flakes, arranged in lines or ripples; associated with cirrostratus at right. *Photo by H. Floreen.*



Fig. 21. Cirrostratus. A structure of parallel bands is plainly visible; patches of altocumulus and lenticular altostratus below. *Photo by H. Floreen.*



Fig. 22. Altocumulus. A sheet of altocumulus at one level, composed of soft, flattened, rounded masses with a structure in two directions; thick enough to be rather heavily shaded in places, but with interstices where the blue sky appears. *Photo by H. Floreen.*



Fig. 23. Altocumulus in Patches, with Stratocumulus Below and Altostratus at Upper Right. *Photo by H. Floreen.*



Fig. 24. Lenticular Altocumulus. Small, well-defined, lens-shaped masses against a background of an altostratus veil. *Photo by H. Floreen.*



Fig. 25. Altostratus. A thin, semitransparent layer of altostratus covering the sky, with patches of fractostratus, at a lower level, in the center and at left. *Photo by H. Floreen.*

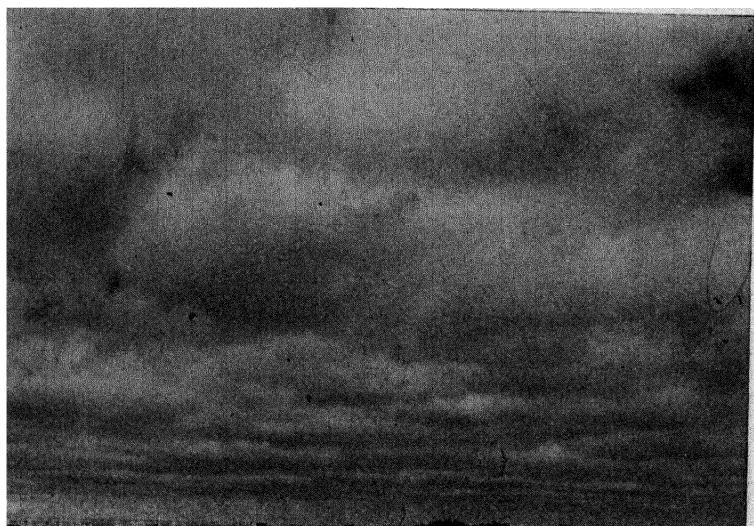

Fig. 26. Stratocumulus Layer, Showing Some Light and Shade Contrasts Near the Zenith and a Roll Structure Near the Horizon. *Photo by H. Floreen.*

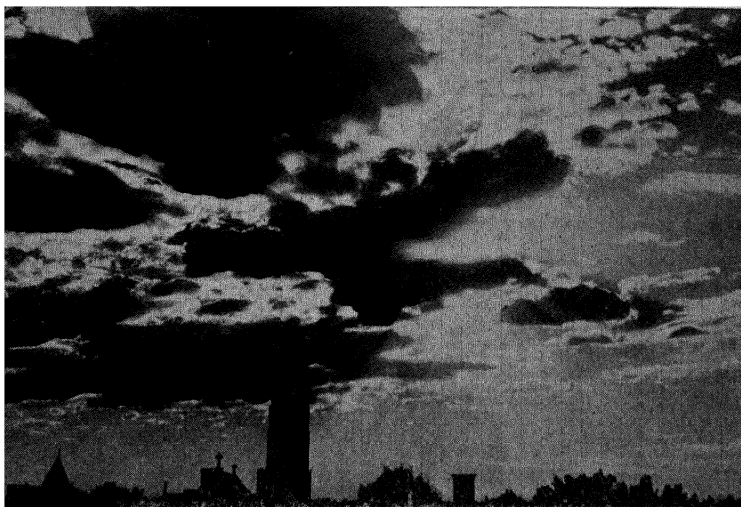

Fig. 27. Stratocumulus in a Broken Layer, Showing Rolls and Lines. The dark shadows indicate considerable thickness of cloud masses. *Photo by H. Floreen.*



Fig. 28. Stratus. A low, nearly uniform layer obscuring a mountainside; shreds of cloud extend down the hillside. *Photo by H. Floreen.*

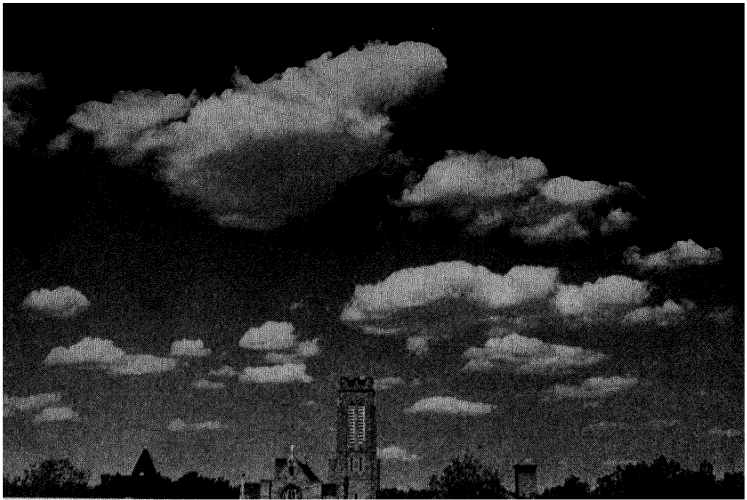

Fig. 29. Cumulus of Fine Weather. Scattered masses with a flat and deflated appearance, the horizontal extension being greater than the vertical. The small areas of light shadow show that the thickness is not great. *Photo by H. Floreen.*



Fig. 30. Cumulus. Typical, detached, growing cumulus masses, with flat bases and with domes suggesting cauliflower heads. *Photo by H. Floreen.*

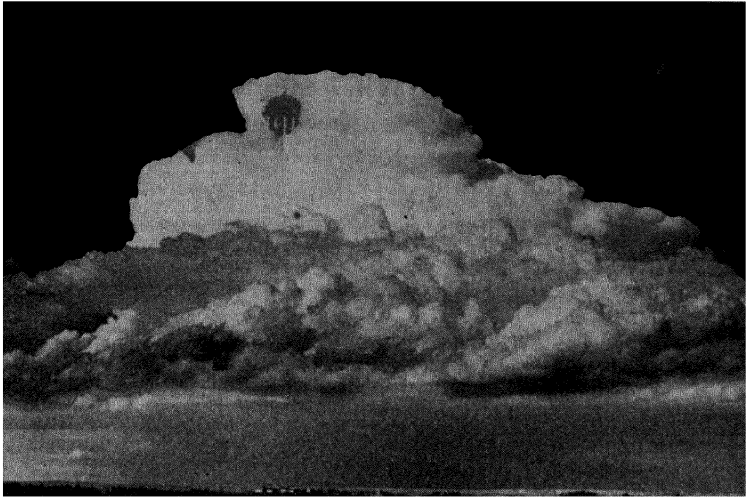

Fig. 31. Cumulonimbus. An anvil is beginning to form in which the cauliflower domes, still seen in the lower portions, have given place to a fibrous structure. A cirrus scarf appears on the left side of the anvil cloud. *Photo by H. Floreen.*

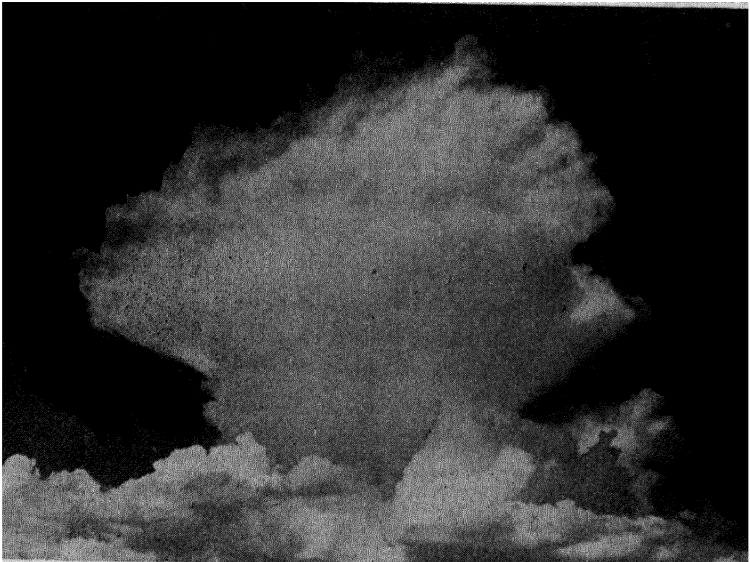

Fig. 32. Cumulonimbus with Completely Formed Anvil. The edges of the anvil are frayed out into cirrus forms having a structure very different from the rounded cumulus forms below. *Photo by H. Floreen.*

composed of small white flakes or of very small globular masses, without shadows. These masses are arranged in groups or lines, or more often in lines resembling those of the sand on the seashore. The term "mackerel sky" has been popularly applied to this latter form because of its resemblance to the patterns on the mackerel's back.

3. *Cirrostratus* (Cist.).—A thin whitish veil which does not blur the outline of the sun or moon, but gives rise to halos; sometimes it merely gives the sky a milky look, sometimes shows a fibrous structure with disordered filaments.

4. *Alto cumululus* (Acu.).—A layer, or patches, composed of flattened globular masses, with or without shading. The masses are arranged in groups, in lines, or waves, and are sometimes so close together that their edges join. Castellated altocumululi are cumuliform masses with more or less vertical development, arranged in a line, and resting on a common horizontal base, which gives the cloud a crenelated appearance.

5. *Altostratus* (Ast.).—Striated or fibrous veil, more or less gray or bluish in color, like thick cirrostratus but without halo phenomena; the sun or moon shows vaguely or is sometimes completely hidden. Rain or snow may fall from altostratus, and from any of the following forms.

6. *Stratocumululus* (Stcu.).—A layer or patches of flakes or globular masses; the smallest of the regularly arranged elements are fairly large; they are soft and gray with darker parts, arranged in groups, lines, or rolls. Often the rolls are so close that their edges join together; when they cover the whole sky they have a wavy appearance.

7. *Stratus* (St.).—A uniform layer of cloud, resembling fog, but not resting on the ground. When this very low layer is broken up into shreds it is designated *fractostratus* (Frst.).

8. *Nimbostratus* (Nbst.).—A low, amorphous, and rainy layer, of dark gray color and nearly uniform. When it gives precipitation, continuous rain or snow results, but it

should be called nimbostratus even when no rain or snow falls.

9. *Cumulus* (Cu.).—Thick clouds with vertical development; the upper surface is dome-shaped and exhibits protuberances, while the base is nearly horizontal. When the light comes from the side, the clouds exhibit strong contrasts of light and shade; against the sun they look dark with a bright edge. A broken cloud resembling a ragged cumulus in which the different parts show constant change and are without well-defined upper and lower limits is called *fractocumulus* (Frcu.).

10. *Cumulonimbus* (Cunb.).—Heavy masses of cloud with great vertical development, whose summits rise in the form of mountains or towers, the upper parts having a fibrous texture and often spreading out in the shape of an anvil; generally producing showers of rain, snow, or hail, and often thunderstorms. The base often has a layer of low, ragged, fractostratus or fractocumulus clouds below it. Masses of cumulus clouds, however heavy they may be, should not be classed as cumulonimbi unless the whole or a part of their tops is transformed, or is in process of transformation into a cirrus mass.

A cloud form called *nimbus* (Nb.) was included in former classifications, instead of nimbostratus, and was defined as a thick layer of dark clouds without shape and with ragged edges from which steady rain or snow usually falls. It was discarded because of confusion in its application, the name being applied sometimes to nimbostratus forms as defined above and sometimes to fractostratus and fractocumulus forms.

Height and grouping of cloud forms.—The elevation of clouds varies greatly among the different types and also in the same type on different occasions. Cirrus and cirrostratus have the greatest average elevation, being observed most frequently at heights of 5 to 7.5 miles (8–12 km.). Cirrocumulus is most often found between 3.5 and 4.5 miles (5.6–7.2 km.); altocumulus between 1.2 and 2.5 miles (2–4

km.); and altostratus at quite variable heights, being frequently observed at an altitude of about 2 miles (3 km.) and sometimes above 5 miles (8 km.). The cirrus forms are called *high clouds*; altostratus and altocumulus, *middle clouds*; and the five remaining forms, *low clouds*. The latter are sometimes as low as $\frac{1}{2}$ mile (0.8 km.) or less, but mostly between 1 and 2 miles (1.6–3.2 km.).

Cirrus, cirrocumulus, altocumulus, and cumulus clouds are in detached masses, usually covering only a part of the sky, and may be called fair weather clouds, since rain does not fall from these forms. "Every cloud engenders not a storm." The remaining types, cirrostratus, altostratus, stratocumulus, stratus, nimbostratus, and cumulonimbus form more or less continuous layers and often cover the entire sky. Precipitation may occur from any of these except cirrostratus. Cumulus and cumulonimbus are of great vertical depth, the tops of the clouds sometimes extending 2 or 3 miles above their bases. The other forms are more like layers or sheets, comparatively thin but of great horizontal extent. These general characteristics help to identify the various forms, but it should be remembered that there are all manner of gradations between them, and in some cases one form merges imperceptibly into another. Frequently it is not possible to identify clouds with certainty, unless one has watched their evolution or can interpret the physical processes that are producing them.

Records of clouds and cloudiness.—When a weather observation is being made, the kinds of clouds visible should be recorded, the amount of each kind, and the direction from which each is moving. The amount is estimated in tenths of the sky covered. Such observations give information with regard to the direction, velocity, and turbulence of the wind at different elevations, and are often of direct aid in foreseeing weather changes. The Weather Bureau records each day as clear, partly cloudy, or cloudy, according to the average cloudiness during the time between sunrise and sunset; clear, if the average cloudiness is three

tenths or less; partly cloudy, if between four and seven tenths; and cloudy, if eight tenths or more.

Precipitation Observations

Precipitation, in meteorology, means either the falling of moisture to the earth in any form, or the quantity of water so deposited, expressed in depth of water. Precipitation takes various forms, such as rain, snow, hail, and other special formations, which are discussed in more detail in the chapter on Condensation; but dew, frost, and fog are not regarded as precipitation. Amount of precipitation always means the liquid content. The word *rainfall* is often used as synonymous with precipitation, meaning the amount of water in whatever form it may have fallen.

Rain gages.—The object of a rainfall measurement is to obtain the thickness of the layer of water that has fallen, assuming it to be evenly distributed over the surface in the vicinity of the measurement. Any open vessel of the same cross section throughout and exposed vertically will serve as a rain gage. A cylindrical vessel 6 to 10 inches in diameter is preferable. The accuracy of measurement can be increased by measuring the catch in a vessel smaller than that in which it is received, if the ratio of the cross sections of the two vessels is definitely known.

The 8-inch rain gage.—In the 8-inch rain gage, which is the standard gage used by the coöperative observers of the Weather Bureau, a cylindrical receiver, exactly 8 inches in diameter, is provided with a funnel-shaped bottom. This funnel conducts the rain caught by the receiver into a cylindrical measuring tube, 20 inches long and exactly 2.53 inches in diameter. For a given length, the volume of the measuring tube is, therefore, just one tenth of the volume of the receiver, since their volumes vary as the squares of their diameters. The depth of rainfall is, accordingly, magnified just 10 times. For 1 inch of rain, the water is 10 inches deep in the measuring tube and for 0.01 inch of rain, it is 0.1 inch deep. Thus the amounts can easily

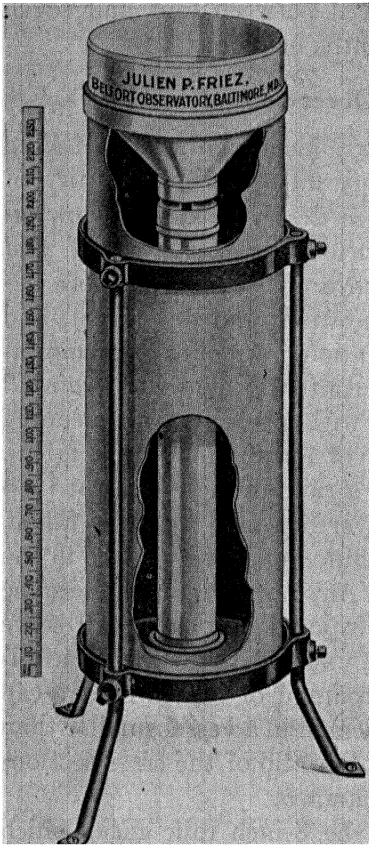

Fig. 33. Rain Gage. Standard 8-inch pattern, with measuring stick. Courtesy, J. P. Friez & Sons, Baltimore, Md.

be measured with great precision. The depth is measured by a small rule or measuring stick, graduated in inches and tenths. The receiving funnel fits over an outer tube, 8 inches in diameter, which serves to support the receiving funnel and also to hold excess water when more than 2 inches of rain falls, and the inner measuring tube, which is 20 inches long, consequently overflows.

Recording gages. — The tipping-bucket recording rain gage used by the Weather Bureau has a 10-inch receiving funnel, at the mouth of which is a bucket of two compartments, so mounted that one or the other receives the water coming from the funnel. As one compartment fills, it tips, thereby emptying its water and presenting the other compartment to the

mouth of the funnel. The compartments are of such size with reference to the receiving funnel, that each tip represents 0.01 inch. As the bucket tips, it closes an electric circuit connected with the meteorograph. A permanent record is thus obtained of the time of occurrence of each 0.01 inch of rain, and consequently the amount of the fall in any given period. There are other devices for obtaining continuous records of rainfall, one of which is a method of

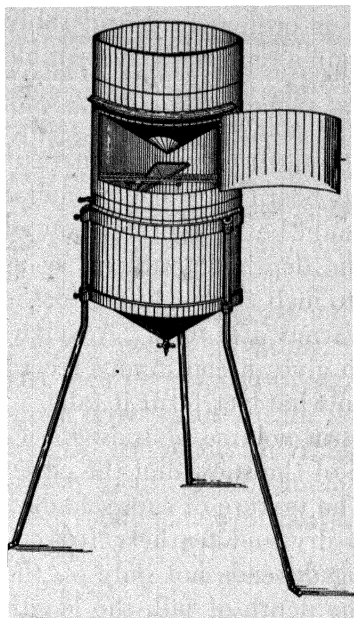

Fig. 34. Tipping-Bucket Rain Gage Used by the United States Weather Bureau. Each 0.01 inch of rain is electrically recorded.

recording the movement of a float which rises as water accumulates in the gage.

Exposure of rain gage.—To obtain a correct catch of rain with any gage, the gage should be exposed on the ground in an open level space at least as far from trees, buildings, or other high objects, as they are high, in order that rain falling obliquely may not be intercepted. Windbreaks at a distance greater than their height are desirable as a means of checking the velocity of the wind. If the gage is placed much above the ground, the higher wind velocities carry more of the

water around and over it. An exposure on the edge of a roof is especially bad because of eddies of wind around the gage.

Measurement of snow.—Two quantities are desired in the measurement of snowfall, namely, the actual depth of the snow and its water equivalent. Both measurements present some difficulty in practice. Snow does not ordinarily lie at a uniform depth over the ground but drifts, even in moderate winds. Hence, measurements of the depth should be made at several different places, apparently representative, and the average of these measurements taken as the depth of the snow and recorded in inches and tenths.

To obtain the amount of precipitation from snow, that is, its water equivalent, the snow may be melted and measured as rain, or it may be weighed. Since snow readily blows around the top of a gage instead of falling into it,

the amount caught by the gage is ordinarily considerably less than the actual fall. To obtain a representative sample for melting, the outer, overflow, tube of the 8-inch gage may be forced downward through a layer of snow, representing the average depth of fall, and the section thus cut out lifted up by placing a thin board or sheet of metal underneath it. This sample should be melted and poured into the measuring tube and the depth determined as in the case of rain. The best way to melt snow without loss is to add a measured quantity of warm water to it. A weighing gage has been devised which gives a continuous record of the amount of precipitation in whatever form it falls.

The amount of water in a given volume of snow varies greatly, according to the texture of the snow and the closeness with which it is packed. The texture of snow changes with its temperature from very dry and feathery to very moist. The closeness of packing depends not only on the texture as it falls but also on the depth of fall, the length of time it has lain on the ground, and the temperatures to which it has been subjected since falling. In very moist, newly-fallen snow, 6 inches of snow may make 1 inch of water, while in small amounts of very dry, fluffy snow, the ratio may be as high as 30 to 1. In the absence of definite information, the ratio of 10 inches of snow to 1 inch of water is frequently used as an average. In large drifts which have accumulated all winter and are melting in the spring, 2 inches of snow may be equivalent to 1 inch of water.

Precipitation records.—A daily precipitation record should include the kind and amount of precipitation, and the time of beginning and ending. Snow is recorded as dry or moist. A record is made of the depth of snowfall since the last observation and also of the total depth on the ground. From the recording rain gage, the amounts of rain in 5, 10, 15, and 30 minutes, and in 1, 2, and 24 hours should be tabulated. When *excessive rainfall* occurs, the accumulated amounts in successive 5- or 10-minute

periods are tabulated. Rainfall is considered excessive when it falls at the rate of 0.25 inch in 5 minutes, 1 inch in 1 hour, or 2.50 inches in 24 hours.

From a long series of such records at a fixed point, normal daily, monthly, and yearly values may be determined; also the greatest and least yearly and monthly amounts, and the greatest amounts in short periods of from 5 minutes to 48 hours. The record should also show the number of rainy days by months and by years, and their averages over the period of record. A rainy day is a day on which 0.01 inch or more of precipitation occurs; that is, days on which only traces of rain fall are not counted as rainy days in this country. Unusually long periods without rain, known as droughts, should also be noted because of their great economic significance.

Sunshine Observations

Man's best health and growth demand some exposure of his body to direct sunshine. Some of the growth processes of plants are directly dependent on the sun; the energy carried by the sun's rays to the green leaves of plants is transformed into chemical activity and growth. Satisfactory yields of crops depend in part on the crops' receiving an adequate amount of sunshine. It is evident, therefore, that sunshine is an important element of the weather.

Sunshine recorders.—The electric sunshine recorder in use by the Weather Bureau has the form of a straight glass tube with cylindrical bulbs at each end, one bulb being smoothly coated on the outside with lampblack. The air in the bulbs is separated by a small quantity of mercury and alcohol. This tube is protected from the influence of the air temperature by being sealed within an outer glass tube, the space between the two tubes being exhausted of air. Two wires with ends a short distance apart are sealed in the inner tube midway between the bulbs and are connected with the meteorograph, which, as we have seen, also records wind direction, wind velocity, and rainfall.

When the sun shines on this instrument, the black bulb absorbs radiant energy, and the mercury is warmed and rises to surround the ends of the two tubes, permitting an electric current to pass from one to the other. The circuit passes through the meteorograph, where it is closed each minute by a rotating contact point on the clock. The completing of the circuit results in a movement of the pen on the cylinder. A mark on the register sheet is thus made each minute when the sun is shining. When the sun is not shining, the bulb cools by radiation, the mercury drops below the contact point, the circuit is broken, and the pen moves across the sheet in a straight line.

The use of this instrument depends upon the fact that

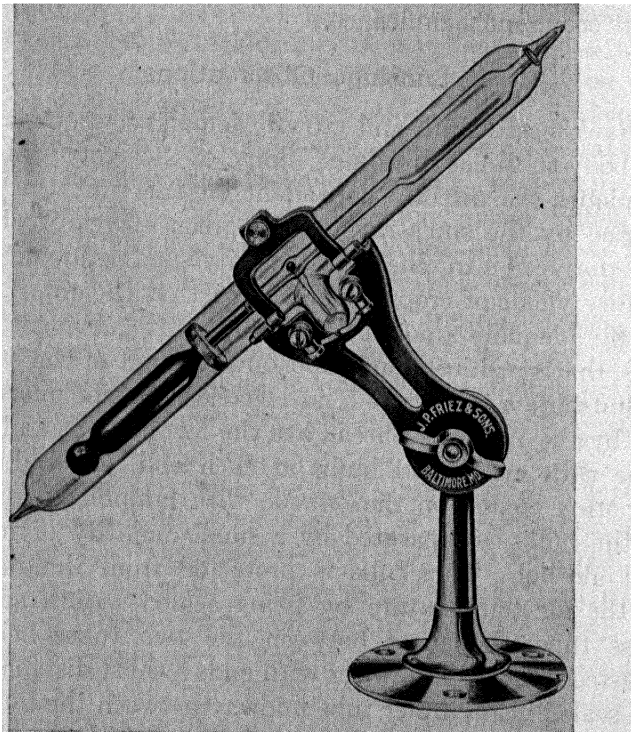

Fig. 35. Electrical Sunshine Recorder. *Courtesy, J. P. Friez & Sons
Baltimore, Md.*

lampblack becomes warmer than clear glass, under direct sunshine. The instrument gives a record of the number of minutes of sunshine, with some lag at the beginning and ending of the sunshine, but no record of the varying intensity of the sun's rays. It is usually adjusted to record whenever the sun is bright enough to cast a visible shadow, except for the half hour or more after sunrise and before sunset. At these times the sun's rays are too weak, that is, are received at the instrument with too little energy, to operate it. The Campbell-Stokes recorder used in England consists of a glass globe which focuses the sun's rays and thus chars a track on a graduated card. The sun itself thus writes with fair accuracy an original record of the duration of sunshine.

Sunshine records.—From such instruments records are obtained of the duration of sunshine each day. The percentage obtained by dividing the actual sunshine by the possible sunshine for the day is usually calculated and recorded. For the month and the year, the total number of hours of sunshine and the percentage of the possible are important data.

Observations of Visibility and Ceiling

The advent of air navigation at great speed has given increased importance as a weather element to the clearness of the atmosphere, the distance at which objects can be seen, and the height of the clouds. Information on these matters is obtained by observing visibility and height of ceiling.

Visibility.—As officially defined by the Weather Bureau for purposes of observation and record, visibility is the greatest distance toward the horizon at which prominent objects, such as mountains, buildings, towers, and so forth, can be seen and identified by the unaided eye. This distance depends upon the clearness of the air, and is modified by the turbulence of the air and by the presence of haze, dust, smoke, fog, rain, and snow. Visibility records

are made by eye observations of stationary objects at known distances from the observer, and may be expressed either directly in miles or meters, or indirectly according to an arbitrary scale of numbers. The scale in common use extends from visibility 0, when one cannot see more than 55 yards (50 m.) to visibility 9, when objects at a distance of over 31 miles (50 km.) may be distinguished.

Ceiling.—The word “ceiling” has come into meteorological use since the beginning of aviation, and in that time has undergone some change in meaning. It frequently happens that a layer of cool air has a layer of warmer air resting upon it at some moderate elevation above the earth. The two layers of air are apt to be moving in different directions and at different velocities. There will then be turbulence and eddy motion at the surface where they meet, sufficient to give a sharp jolt to an airplane passing from one layer to the other. This surface was given the name of “ceiling” or “lid.” There may be several such “lids” in the air. However, there is a tendency for clouds to form, and for smoke and dust to collect and spread out laterally at the bottom of such a warm layer, as will be seen from the discussion of convection. Hence “ceiling” has come to mean in common usage the base of any cloud layer.

For purposes of observation and record at the airway stations of the Weather Bureau, ceiling is now defined as the altitude in feet of the base of any clouds at or below 9,750 feet above the station and covering more than half of the sky. If there is dense fog, heavy precipitation, blowing snow, or other factors reducing the visibility to one fifth of a mile or less, and preventing observation of cloudiness, then the ceiling is recorded zero. The ceiling is said to be unlimited when the sky is clear or the clouds are above 9,750 feet; that is, so high as to be of no practical significance in ordinary flying. Between these limits the height of the ceiling is reported to the nearest 100 feet up to 5,000 feet and to the nearest 500 feet at greater elevations, up to 9,750 feet.

The height of the ceiling is determined by the use of pilot or ceiling balloons, as explained in the next section, or at night by the use of a "ceiling light" which projects a spot of light on the base of the clouds, enabling the height to be calculated trigonometrically, by measuring the angular elevation of the spot from two points 500 feet apart. When the ceiling is low, the height may sometimes be estimated by observing the unobscured portions of towers, mountains, or other tall objects of which the height and distance are known.

Upper Air Observations

The conditions existing in the free air above the earth's surface are important in theoretical studies of the atmosphere as well as for their direct application to forecasting and for the immediate information of aviators.

Mountain observations.—From about 1870 to 1890 many mountain observatories were maintained in Europe and America. In the United States, meteorological observations were made on Pike's Peak, Colorado (elevation 14,134 feet; 4,308 m.), Mt. Washington, New Hampshire (elevation 6,280 feet; 1,914 m.), and Blue Hill, Massachusetts (elevation 640 feet; 195 m.). Some European observatories and the Blue Hill observatory have been maintained continuously to the present, and observations have recently been resumed on Mt. Washington. These observations have given and are giving valuable information, but the conditions on mountain tops are not the same as in the free air at the same elevations, and observations of the latter also are needed.

Balloons.—During the first half of the nineteenth century, occasional ascensions were made in either free or captive manned balloons, that is, in balloons carrying one or more passengers, for the purpose of making meteorological observations. And since 1931 and 1932, when Piccard made his flights to heights of about 10 miles, there has been a revival of interest in the use of manned balloons for the

purpose of reaching heights hitherto unattained by man. The so-called stratosphere balloons of recent years carry a sealed gondola for housing the crew and numerous recording instruments. At present the record height attained is that reached by Stevens and Anderson from Rapid City, South Dakota on November 11, 1935, in the balloon called *Explorer II*. They are officially credited with a height of 72,395 feet (13.71 miles; 22.06 kilometers).

What are called *sounding balloons* or *ballons-sondes*, came into frequent use after 1893 as a means of exploring the upper air. They are free, rubber balloons, carrying light recording instruments. They frequently reach heights of 15 miles and have attained a record height of about 23 miles. As the balloon rises into air of decreasing pressure, it expands until it finally bursts. The instruments are then lowered to the ground by a parachute, and bear a tag offering a reward to the finder for returning them to the place of release. These balloons are still used, particularly for making special surveys of upper air conditions at stated times.

Pilot balloons are small rubber balloons inflated with hydrogen, floating freely in the air but carrying no instruments. The course of such a balloon is watched and plotted from the ground by the use of a surveyor's theodolite for observing its direction and angular elevation. If two theodolites at a known distance apart are used, the height and position of the balloon at the end of each minute can be computed accurately. If only one theodolite is used, it is necessary to assume a certain rate of ascent and for this an empirical formula is used. From such observations the direction and velocity of the wind at various levels and the height of the clouds can be quickly determined. Regular flights of pilot balloons every 6 hours are made at a number of Weather Bureau stations throughout the United States, particularly along and near the main air routes. At many airports modified pilot balloons, called *ceiling bal-*

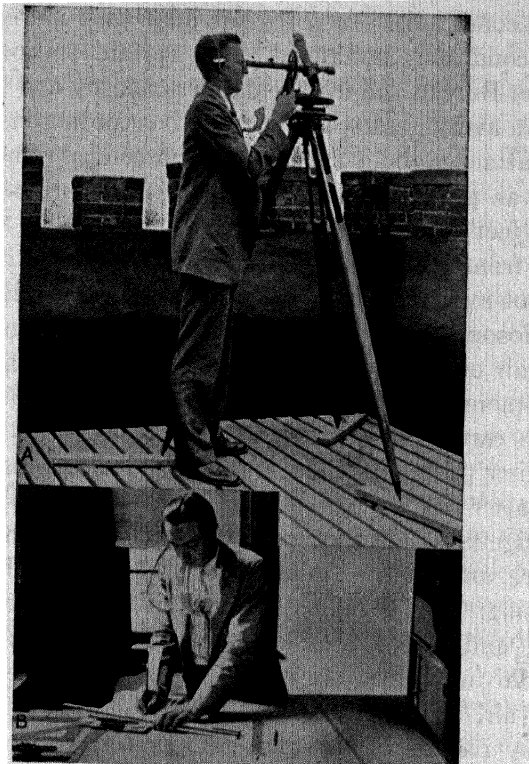

Fig. 36. Pilot Balloon Observation. *A*, observer following the balloon with a theodolite and telephoning its angular elevation and azimuth at one-minute intervals to *B*, computer at plotting board. *Courtesy, U. S. Weather Bureau, Washington, D. C.*

loons, are used to determine the height of the lowest cloud layer.

Kites and airplanes.—From 1898 to 1933 the Weather Bureau maintained a number of kite-flying stations at which systematic records of upper air conditions were obtained. Box kites were used to carry recording instruments aloft at regular hours each day except when the surface wind was too light to lift the kite. The kites sometimes reached heights of about four miles. During 1933, kites were replaced by airplanes as a means of obtaining records of up-

per air conditions. At a regular hour each morning when flying conditions permitted, from certain stations of the Weather Bureau and from a number of Army and Navy stations, an aviator started upward with recording instruments firmly attached to his machine. He ascended as nearly vertically as practicable and reached an elevation of about 17,000 feet (3.22 miles; 5.2 kilometers). The flights required from 1 to 1½ hours for completion and the records were not available until the plane returned to the ground.

Radiosondes.—Since about 1937 the greater number of upper air observations have been obtained by radiosondes (radio-meteorographs). These are little radio sending-stations carried aloft by sounding balloons. As the instrument rises through the air, and also as it descends by parachute after the balloon bursts, it automatically transmits radio signals at brief intervals, indicating the temperature, pressure, and relative humidity of the air through which it is passing. The signals are received at the ground, amplified, and recorded on a drum. The records are thus available for immediate use while the instrument is still in the air.

Many records of pressure, temperature, humidity, and wind have been obtained by the use of kites, airplanes, and radio sounding instruments. Such records have contributed much to our knowledge of the physics of the air and of its general circulation. The daily observations are also of immediate use in forecasting weather and in advising aviators of conditions at various levels in the air and how these conditions are likely to change. From the data thus obtained, maps and graphs of upper air conditions at various levels up to three miles are constructed. These are of value in interpreting what is happening and in foreseeing what is likely to happen in the air; that is, in explaining and forecasting weather changes.

A standard observation of the Weather Bureau.—The form illustrated in Fig. 37 is used by the observer in making a part of the standard weather observation. The record

of amount, kind, and direction of clouds represents the judgment of the observer from eye observation. Visibility is the horizontal distance that objects near the surface can be seen, expressed in miles, and cloud height is given in feet, estimated or obtained by ceiling balloon. Wind direction is obtained by observing the wind vane. It may be confirmed indoors and the velocity in miles per hour obtained by reference to a triple register or a wind indicator device. Present weather is recorded in a numerical code: 01 in Fig. 37 indicates partly cloudy; 02, cloudy; 93, thunderstorm in progress; 03, overcast. The reading of the dry thermometer is the air temperature at the time of observation. The reading of the wet thermometer gives a means of calculating the dew point, relative humidity, and vapor pressure, as previously explained. If the precipitation is in the form of rain, the amount is determined by the stick measurement of the water in the measuring tube of the rain gage. This amount is checked with the record on the register sheet. The sheet may be in error by as much as 10 per cent. Snow is measured as has been explained. The minimum thermometer indicates the lowest temperature since it was set six hours previously, and the maximum thermometer the highest in the same period.

In addition to these outdoor observations, instruments within doors are read for determining the following values: wind velocity; maximum velocity for a 5-minute period and its direction; station pressure; pressure reduced to sea level; pressure tendency and change during the past three hours. The character of all precipitation and the times of its beginnings and endings are also recorded. All the observed and calculated values are entered on a large form, which constitutes a permanent original record of the weather. As will be noted in Fig. 37, observations are made four times daily at 6-hour intervals, 1:30 A.M. and P.M., and 7:30 A.M. and P.M., 75th meridian time. Complete observations, as described, are made at airport offices of the Weather Bureau; many city offices omit portions of the record. These

records constitute a valuable history of the weather. They are the fundamental data for studies of weather and climate, and they have many specific, practical applications. When simultaneous observations from many stations are collected by telegraph and the data entered on an outline map, a daily picture of weather conditions is obtained. Such a map is called a weather map and is the basis of weather forecasting.

(STATION) <u>GRAND ISLAND, NEBR.</u>				
(DATE) <u>SEPT. 1</u> TO <u>SEPT. 2</u> 19 <u>41</u>				
TIME OF OBSERVATION (E.S.T.)	1:30P	7:30P	1:30A	7:30A
TOTAL CLOUDS	4	7	10	9
VISIBILITY	10	15	10	9
DIRECTION OF WIND	SE	SE	SE	SSW
PRESENT WEATHER	01	02	93	03
DRY THERMOMETER	86.7	85.7	64.3	65.0
WET THERMOMETER	65.0	64.8	64.2	64.8
CLOUDS, LOW C _L	0	Cu	St	St
CLOUDS, MIDDLE C _M	0	Acu	0	Acu
CLOUDS, HIGH C _H	Ci	Cst	0	0
CLOUDS, HEIGHT	10000	6000	7000	8000
CLOUDS, DIRECTION	W	SW	—	—
AMT. PRECIP. AT OBN.	0	0	.58	.02
MIN. THER. AT OBN.	58.7	84.8	63.4	63.1
DEPTH SNOW ON GROUND	0	0	0	0
MAX. THER. AT OBN.	88.0	91.3	85.8	65.7

Summary

Water changes its state readily from solid to liquid to gas, and in the reverse order, also directly from solid to gas and gas to solid. The change from solid or liquid to gas by the process of evaporation results in the presence of water vapor in the air. The vapor mixed with the permanent gases of the air exerts a gas pressure as a part of the total air pressure. When a certain vapor pressure, depending on the temperature, is reached, evaporation ceases. The space is then said to be saturated, and the pressure then exerted by the water vapor is the saturation pressure. For any given temperature there is a definite saturation pressure, and for any given vapor pressure a definite temperature at which saturation occurs. This saturation temperature is called the dew point. When the vapor pressure becomes greater than the saturation pressure, as when the vapor is cooled below its dew point, condensation begins.

The amount of water vapor in the air may be expressed by its mass per unit volume or by the pressure it exerts, and is known as absolute humidity. Specific humidity is the weight of water vapor present per unit weight of moist air. The ratio, expressed in per cent, of the actual quantity of water vapor to the saturation quantity at the same temperature, or of the actual vapor pressure to the saturation vapor pressure, is the relative humidity. Absolute and relative humidity change when the pressure or temperature changes, but specific humidity remains constant unless there is an actual gain or loss of moisture. The rate at which evaporation from a water surface occurs increases as the temperature and wind increase, and decreases as the relative humidity increases. The relation between relative humidity and rate of evaporation and consequent cooling is utilized in obtaining, from readings of the sling or whirled psychrometer, the relative humidity and dew point of the air at a given time.

Clouds are small particles of water or ice condensed from

the water vapor of the air. The international classification recognizes ten type forms, comprising the three primary forms, cirrus, stratus, and cumulus, and their modifications. There are numerous subtypes and gradation forms in addition to the ten main types. The higher forms range in general from 1 to 8 miles in elevation, and the lower types from $\frac{1}{2}$ mile to 2 miles. (The tops of cumuli are often at a considerably greater altitude than 2 miles). Clouds typically occurring in detached masses do not produce precipitation; those occurring in continuous layers, except cirrostratus, frequently do. Cloud observations include kind, amount in tenths of the sky covered, and direction of movement. The sky is recorded as clear, if not more than three tenths covered; partly cloudy, if four to seven tenths covered; and cloudy, if eight tenths or more is obscured.

The principal problem in the measurement of precipitation is to secure a representative catch. In the case of rain, the problem is solved with fair accuracy by the use of a cylindrical rain gage, 8 or more inches in diameter, exposed at the ground in an open space, with windbreaks at a distance somewhat greater than their height. In the measurement of snowfall a representative depth must be determined by several measurements, and a representative sample must be removed and melted or weighed to determine its water content. Continuous automatic records of rain are of particular value for showing the rate of fall of heavy rains in short periods of time.

The duration of sunshine and the percentage of the possible amount are important meteorologically and agriculturally, and some form of sunshine recorder is in use at all first-order weather observing stations. The horizontal distance at which objects can be identified (visibility) and the vertical distance to the lowest cloud layer (height of ceiling) are meteorological data of special value in aviation. Observations of atmospheric conditions at various elevations above the surface are made by carrying aloft recording instruments attached to sounding balloons, kites, and air-

planes. Wind direction and velocity aloft are determined by watching the flight of pilot balloons. Valuable information is also obtained by observations on mountain tops.

Problems

1. Find dew point, relative humidity, and vapor pressure when the dry thermometer reads 60° and the wet thermometer reads 52° .
2. Find dew point and vapor pressure when the temperature is 73° and the relative humidity 28 per cent.
3. Find relative humidity and vapor pressure when the temperature is 35° and the dew point 21° .
4. Outside air at a temperature of 25° and a relative humidity of 62 per cent is taken into a room and warmed to a temperature of 75° without the addition or loss of moisture. What is its new relative humidity?
5. Find the dew point, relative humidity, and vapor pressure of the air at the time of the four observations given in Fig. 37.
6. Air having a temperature of 50° and a relative humidity of 49 per cent, cools during the night to a temperature of 32° . What does its relative humidity become?
7. If the total pressure of the air at a given time and place is 29.620 inches, and the partial pressure due to the water vapor is 0.250 inch, what is the specific humidity of the air in grams per kilogram?
8. A fall of one inch of rain amounts to how many tons of water per acre? Per square mile? (A cubic foot of water weighs 62.4 pounds.)
9. The area of North Carolina is 52,426 square miles, and its average July rainfall is 5.78 inches. What is the weight of the water that falls?

CHAPTER IV

Solar Radiation and its Effects

In observing and measuring the weather and its changes, we have noted how extraordinarily variable is the temperature of the air. It is now necessary to examine more closely into the way in which the air is heated and cooled, and into some of the physical effects of its variations in temperature; for very many of the phenomena of the weather have their origin in temperature changes.

Radiant Energy

If you stand before a fireplace, the heat that reaches you from the burning coals is said to travel through the intervening space as radiant energy. It would reach you in the same way if there were no air in the space. The fuel loses the energy which is thus sent out through space in a form having many of the characteristics of transverse waves. These are known as *ether waves* or *electromagnetic vibrations*, and the energy thus transferred is called radiant energy or radiation.

Radiation.—Radiation refers both to the radial emission of energy from an object and to the energy so transferred. The movement of energy through “empty space” in a manner suggesting waves, but without the agency of any material medium, is mysterious, and it is not possible to form a mental picture of how it is accomplished, but there is complete evidence that waves of energy do travel in this way and that every body in the universe, whether hot or cold, has the faculty of thus emitting some of its energy. For example, the earth loses some of its heat to space continu-

ously day and night, and is said to "cool by radiation." Of course, by day, when the sun is shining clearly, the earth probably is gaining more energy from the sun than it is losing to space. The rate of radiation increases as the fourth power of the temperature expressed in the absolute scale; doubling the absolute temperature of a body results in its sending out radiant energy sixteen times as fast.

Length, frequency, and velocity of ether waves.—The length of a wave is the distance between two adjacent crests or pulses; the frequency is the number of waves per second. These two quantities are inversely proportional. There is great variation in the length and frequency of radiant energy waves; arranged according to their lengths, they form an extensive band or spectrum (see Fig. 38).

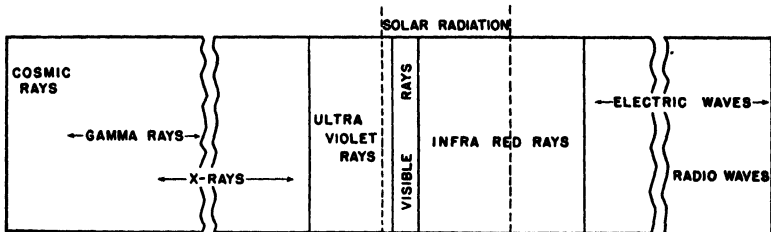

Fig. 38. Diagrammatic Representation of Radiant Energy Spectrum. The figure needs to be greatly elongated to represent the correct ratios of the wave lengths, which vary between 10^{-14} meter and 30,000 meters.

At one end are the extremely short waves, known as cosmic rays, gamma rays, and x-rays; next in order with increasing wave length and decreasing frequency come the ultra-violet rays, the visible light rays, and the infra-red, or so-called "heat rays"; and finally the Hertzian electric waves, including those used in radio transmission. The visible rays of light have a length extending from about 3.8 to 7.6 ten-millionths of a meter; the waves used in wireless telephony may vary from 10 to 30,000 meters.

The waves received from the sun and those sent out by the earth are those with which we are particularly concerned in meteorology. The sun's rays include not only the

visible light rays, but extend from the ultra-violet far into the infra-red, making the sun's spectrum in its entirety at least 10 times as long as the part which we see. Radiation from the earth is always of long heat waves. The use of the expression "heat waves," as applied to the long-wave radiation emitted by warm or hot bodies, is misleading, since all ether waves produce heating effects when absorbed. All radiation of whatever wave length travels through space and through air at the approximate velocity of 186,300 miles per second or 299,800 kilometers per second. This is generally called the *velocity of light*.

Transmission, absorption and reflection.—Not only does radiant energy travel through space without the presence of any material substance, but portions of it also pass through certain kinds of matter. Light rays, for example, travel through air, water, and glass, and x-rays and other short waves through denser, opaque substances. In these cases the radiation is said to be *transmitted*; it is not itself affected and has no effect on the matter through which it passes. Most substances show a selective transmission; that is, some of the wave-lengths get through, others do not. For example, window glass admits the light from the sun, but it does not transmit outward the long heat waves originating in the room. Different substances select different wave lengths for transmission.

That portion of the radiant energy which enters a substance but is not transmitted through it, is said to be *absorbed*. It thereby ceases to be radiant energy and is changed into some other form of energy, often into heat, but sometimes into the energy used in evaporation or in chemical changes. Only the radiation that is absorbed has any effect on the object with which it comes in contact. Selective transmission implies the converse, selective absorption; those wave lengths not selected for transmission are absorbed. A radio receiving set illustrates the selective transmission and absorption of electromagnetic waves. It has a device by which certain wave lengths are selected for am-

plification, and others are "tuned out." Some of the waves reaching a material surface may be *reflected*, that is to say, turned back without entering the substance. The only result is to change the direction of motion of the waves. The reflection may be *regular*, as from a mirror or other smooth surface, or *diffuse*, like that from the surface of the ground. Objects are made visible by reflection; those that reflect no light can not be seen, unless they themselves are emitting light waves.

Insolation

The heat of the atmosphere and of the surface of the earth is derived almost wholly from the sun. The amounts received from the moon, planets, stars, and the earth's interior are negligible in comparison, as is evident when we remember how the temperature ordinarily rises by day under the influence of sunshine and falls by night when these other factors are equally as effective as by day. This incoming solar radiation, which is of primary importance to meteorology and indeed to all life, is given the special name of *insolation*.

Solar constant.—Although the earth receives but a minute portion of the total radiation emitted by the sun, owing to the small angle subtended by the earth as seen from the sun, the amount received is great. Amount of heat is expressed in calories, a calory being the heat required to raise the temperature of one gram of water by one degree centigrade, beginning with water at 15°C. The average intensity of the solar radiation is found to be about 1.94 calories per square centimeter per minute, at the average distance of the earth from the sun, when measured on a surface perpendicular to the solar beam, and after making allowance for the loss in passing through the atmosphere. This is called the *solar constant*, so named when the intensity was assumed to be invariable within the errors of measurement. Later investigations indicate that there are very slight variations in short periods of a few days, but this is

doubted by many. There is more conclusive evidence that there are variations, amounting to about 3 per cent, in periods of a few years, corresponding to the times of maximum and minimum sunspots. If we assume that in the course of a year half of the energy expressed in the solar constant reaches the earth at latitude 40° , the energy received amounts to more than 5 million kilowatt hours per acre.

The observations fixing the average value of the solar constant and its variations have mostly been made under the direction of Dr. C. G. Abbot of the Smithsonian Institution, and made on mountains in arid regions in the southwestern United States and in Chile. These sites were chosen in order to avoid as much of the dust and moisture of the lower atmosphere as possible. Furthermore, methods have been devised by which the remaining errors introduced by variable losses in the atmosphere can be largely eliminated. These observations have been made since 1918 and disclose a probable range in the solar constant of not more than 3 per cent. The variation is found to be in the blue, violet, and especially the ultra-violet portion of the spectrum, rather than in the greater wave lengths.

Solar radiation measurements.—Continuous records of two values in connection with solar radiation are now obtained at a number of places in various parts of the United States and in other countries. One quantity measured is the intensity of direct solar radiation at normal incidence, that is, on a surface kept at right angles to the sun's rays; the other is the total radiation received on a horizontal surface, including reflected radiation from sky and clouds as well as that coming in a direct line from the sun. The instrument used to measure solar radiation is called a *pyrheliometer*, and is based on the thermoelectric effect—differential heating produces an electromotive force that is closely proportional to the amount of radiation received. The resulting current is recorded by a potentiometer. The data obtained by the use of these instruments are used by

architects and illuminating engineers and in various industries. They are also of importance to botanists and agriculturists, for the growth of plants is closely correlated with the amount of solar radiation they receive.

Amount of Insolation Received at a Fixed Location

It is evident that the energy received from the sun at the surface of the earth differs from the solar constant and averages considerably less. The actual amount received at any point depends on the following factors:

Solar-constant and atmospheric absorption.—The amount of insolation received changes as the solar constant changes, that is, as the actual energy emitted by the sun changes. The amount received also varies as the amount absorbed and reflected by the atmosphere varies. Changing conditions of cloudiness, dustiness, and humidity of the atmosphere are continually altering the amount of radiant energy transmitted to the earth. The most important absorbing constituent of the atmosphere is water vapor. Absorption by water drops is not great, but scattering and reflection by the cloud droplets are large.

Distance of earth from sun.—Since radiation spreads out spherically from its source, the amount intercepted by a given area varies inversely as the square of its distance from the source. The distance of the earth from the sun averages about 93,000,000 miles but varies somewhat during the year because the earth moves in a slightly elliptical orbit. The earth is about 3,000,000 miles nearer the sun on January 1 than on July 1. In consequence, the total insolation reaching the entire earth's atmosphere is about 7 per cent greater in January than in July, although it is evident we of the Northern Hemisphere receive more heat in July than in January. The distance factor, tending to give us more heat in January, is more than offset by the two other influences next to be considered.

Angle of incidence.—As the earth moves about the sun, its axis maintains a nearly constant direction in space,

making an angle of $66\frac{1}{2}^\circ$ with the plane of its orbit. In consequence, the angle at which the sun's rays reach a horizontal surface on the earth changes with the changing position of the earth relative to the sun. On June 21, the sun is vertically overhead at noon at the tropic of Cancer and has its greatest noon elevation at all latitudes north of the tropic and its least elevation in the Southern Hemisphere. On December 21, the positions are reversed, and the angle which the sun's rays make with the horizon is least in northern latitudes and greatest from the tropic of Capricorn southward. These positions are illustrated in Fig. 39. These dates are the summer solstice and the

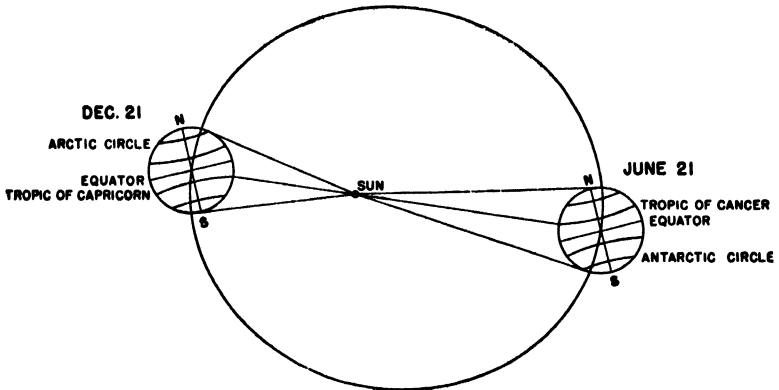

Fig. 39. Position of the Earth with Reference to the Sun, on June 21st and December 21st. Difference in distance of earth from sun, June and December (ellipticity of orbit), is exaggerated to emphasize relative nearness to the sun in northern winter.

winter solstice, respectively, in the Northern Hemisphere; in the Southern Hemisphere the times of winter and summer are reversed.

On its migration northward the sun "crosses the equator," or is directly overhead at noon at the equator, on March 21. On its southward journey it is again in the zenith at the equator on September 23. These dates are called the vernal and autumnal equinoxes with reference to spring and autumn of the Northern Hemisphere and because the days

and nights are then of equal length throughout the world. At other times the days and nights are equal only at the equator. The dates of equinoxes and solstices vary at times by one day because our calendar is not an exact representation of the length of the year.

The variations in the angular elevation of the sun produce changes in the amount of insolation received. A given surface receives most rays when they fall perpendicularly upon it. The same amount of incoming radiation is represented by the two lines, *A*, in Fig. 40. When the rays are perpendicular, they cover an area one of whose sides is

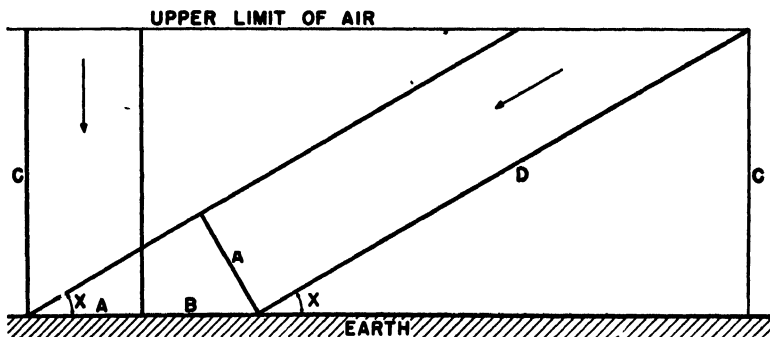

Fig. 40. Effect of Angle of Incidence upon the Spread of Insolation and upon its Length of Path Through the Air. Disregarding atmospheric absorption, the intensity of insolation when the sun has an angular elevation of α , compared with the intensity when the sun is vertical, is the ratio A to $A + B$, which is $\sin \alpha$. The length of path when the sun is vertical, compared with the length when the sun's elevation is α , is the ratio C to D , which is also $\sin \alpha$.

A, but when the elevation of the sun is represented by the angle α , they cover the greater area whose side is $A + B$. The same amount of insolation is thus spread over a greater surface, and the energy received per unit area is less in the ratio of A to $A + B$. The angle of incidence is defined as the angle which the rays make with the perpendicular. In the case of vertical rays the angle is zero; in the case of the slanting rays in Fig. 40 the angle of incidence is $90 - \alpha$. Outside the tropics the noon elevation of the sun is

47° greater at midsummer than at midwinter, and the amount of insolation is accordingly much greater in summer than in winter.

There is also a secondary effect of the angle of incidence on the amount of insolation received at the earth's surface. As the inclination of the rays from the vertical increases, the length of their path through the air increases, in the ratio of C to D , which is the same ratio as A to $A + B$. The longer the path through the air, the greater is the absorption and scattering by the air, especially the lower air. Hence, when the sun is near the horizon, its effect is weakened not only by the spreading out of the rays but also by the loss of heat in passing through much moist and dusty air. Whether the losses due to absorption are more important than those due to inclination depends upon the condition of the atmosphere. It has been found that at Montpelier, France, 71 per cent of the insolation reaches the earth in December, and only 48 per cent in the summer months. There the increased amount of moisture (absolute humidity) in the summer air causes greater losses than does the increased obliquity of the winter sunshine.

Duration of sunshine.—Not only is the angular elevation of the sun greater in summer than in winter, but the duration of sunshine is greater, the days are longer, and the nights shorter. It is evident that, other factors being equal, the amount of insolation received is directly proportional to the length of time during which it is being received. This has a very important effect in increasing summer insolation in the middle and higher latitudes. The effect increases toward the poles, where the sun is continually above the horizon in the summer, and decreases toward the equator, where the days and nights are always of the same length. At latitude 40° there are about 15 hours of possible sunshine in midsummer as compared with about 9 in midwinter. On June 21, the North Pole receives more energy from the sun than does the equator on the same date, but the total amount received during a year at either

pole is only about 41 per cent of that at the equator. An important practical result of the long summer days in high latitudes is that wheat can be grown far northward in interior Canada in spite of a very short growing season, because of the great amount of sunshine during that short season.

Summary.—The important factors governing insolation are: (1) duration of sunshine, (2) angle of incidence, and (3) absorption and reflection by the air. Variations in distance from the sun and in the sun's activity are very minor factors in affecting the amount of insolation received. Except for the small variations in the solar constant, the total radiation arriving at any point on the earth's surface in any 24-hour period depends on the latitude, the time of year, and the clearness of the atmosphere. This statement assumes the presence of a level surface and an uninterrupted horizon.

Direct Effects of Insolation

Effect on air.—When the sun's rays enter the air, some of the radiation is absorbed and some reflected, but when the air is clear and dry, only a small fraction is thus disposed of; the greater part is transmitted to the earth without alteration. Therefore such air is only slightly heated by sunshine, for it is only absorbed radiation that increases temperature. Oxygen and nitrogen are practically transparent to the sun's radiation, and such absorption as occurs in air that is free of dust and moisture is accounted for largely by carbon dioxide in the long-wave "heat" rays of the infra-red, and by ozone in both the ultra-violet and the infra-red waves. Much the greater part of the actual absorption by the gases of the air is by water vapor, which absorbs most of the long-wave radiation. Since the radiation emitted by the earth is all long-wave, the water vapor absorbs a much greater proportion of earth radiation than of solar radiation, and thus acts as a trap to conserve the energy received from the sun.

Solid particles of dust and smoke in the air, and liquid or solid particles of water in the air absorb and reflect considerable, but extremely variable, amounts of insolation. The very dry air of deserts, if it is not filled with dust, absorbs little radiation, and hence the sun has an intense heating effect on solid objects. Elevated regions are above much of the dust and moisture of the air, and consequently there is little absorption by the air above them. Hence the air remains cold, and the sun's rays have much energy left to be absorbed by objects at the surface. That is why one is often warm on winter days in the mountain sunshine, but cold in the shade, the difference between sunshine and shade being much greater than in lowlands.

Clouds have a high reflective power, estimated at about 78 per cent. Much of the reflection from the clouds is outward from the earth and so lost to us, but a part of it is from the upper surface of one cloud to the lower surface of higher clouds and thence to the earth, and some of the heat and light we receive on partly cloudy days consists of this reflected radiation. The earth and lower air cool less rapidly on a cloudy night than on a clear night, not because radiation from the earth is any the less rapid, but because much radiation comes from the clouds to the earth.

Effect on land surfaces.—Of the radiation which gets through the atmosphere and reaches the surface of the earth, a part is reflected back into the atmosphere, and the remainder is absorbed at the surface. The proportion that is reflected by land surfaces varies greatly with the condition and color of the surface. If the land is covered with grass or trees, or is black, cultivated soil, the reflection may be in the neighborhood of 10 per cent. A bare, hard, sandy soil may reflect 20 per cent, and freshly fallen snow 70 to 80 per cent of the incident radiation. On the whole, it is probable that about 40 per cent of the insolation reaching the atmosphere is reflected by the atmosphere and the earth together, and therefore is lost so far as any effect upon either the air or the earth is concerned.

Of the remainder, a part is absorbed by the atmosphere, but most reaches the earth and is there changed into other forms of energy. It is thus that the soil is warmed. Land surfaces are good absorbers and therefore heat rapidly when the sun is shining on them. Moreover, heat does not penetrate deeply into the soil but remains in a thin surface layer, the daily variation being small below 4 inches. For this reason also the surface heats rapidly. But a good absorber is a good radiator, and the land surface that warms rapidly by day cools rapidly by night. Thus a large part of the heat received is soon returned to space. A sandy desert soil exemplifies the maximum of rapid changes in a thin layer. Under such conditions a change of 49°F . from day to night has been observed in the surface layer of soil, while the change was only 1°F . at a depth of 16 inches. Moist soil does not heat so rapidly as dry soil because some of the energy received is used in evaporating the water, and because it takes more energy to heat water than soil.

Snow reflects much radiation and readily absorbs the remainder. A good snow cover protects the land from large daily changes and often prevents its freezing through severe weather. In the spring when the snow disappears, after having persisted for a considerable period, it is often found that the ground beneath is unfrozen, even where near-by bare ground is still frozen hard. In such cases the snow acts as a blanket; heat is conducted from lower ground levels to the surface, but it cannot escape to the air and therefore keeps the surface layer of soil warm.

With the increased insolation of summer, outside the tropics, not all the heat stored by day is lost in the short nights, and the soil becomes progressively warmer. In winter more heat may be lost by radiation through the long nights than is received by day. A land surface therefore becomes hot by day and in summer, and cold by night and in winter.

Effect on water surfaces.—Water surfaces respond to insolation quite differently from land surfaces. In the first

place, and of greatest importance, is the fact that radiation penetrates to much greater depths in water than in land. About one tenth is transmitted to a depth of 30 feet, and small amounts of light have been observed at depths of 1700 to 1900 feet beneath the surface of the sea. Because of the greater absorption near the surface and the mixing of the water by waves, it may be assumed that the radiation absorbed is uniformly distributed through a 30-foot layer. Thus, there is a great volume of water to be heated, as compared with a 4-inch layer of land. In addition, the heat absorbed is often transported great distances by the movements of the water. Other reasons why insolation has comparatively little effect on the temperature of water surfaces are: (a) A large part of the energy absorbed by water, sometimes as much as half of it, is used in evaporating the water, and is therefore not available for raising its temperature. (b) The specific heat of water is greater than that of other natural substances; it takes more heat energy to raise the temperature of an equal weight by an equal amount.

In consequence of these differences, large water areas conserve and equalize their temperatures and change slowly; large land areas have great and rapid temperature changes. The oceans are conservative, the continents liberal. This difference is of fundamental importance in meteorology and climatology, as we shall find.

Although some radiation is absorbed as it travels from the sun to the earth, and some on its journey from the earth out into space, the amount is comparatively small, and the air is not much heated by this process, as is indicated by the fact that the diurnal variation of temperature decreases rapidly with height. At the height of a mile above the surface, the average difference between day and night temperatures is about 1°F. There are, however, three other processes, in addition to the absorption and emission of radiation, which affect the temperature of the lower air. These are conduction, convection, and turbulent movement.

Conduction

One primary cause of temperature changes in the lower air is conduction of heat to or from the earth's surface. *Conduction* is the process by which heat is transferred through matter, without transfer of the matter itself. If one end of a silver spoon be heated, the other end soon becomes hot by conduction, but when one end of a piece of wood is heated, the other end remains cool. Silver is a good conductor of heat, wood a poor conductor. Conduction is always from the warmer to the colder point. On a sunny day, the earth's surface is warmed by absorbing insolation, and then after the earth's temperature has increased above that of the air, the air in contact with it is warmed by conduction. Similarly, at night, the first process is the cooling of the ground, and then the cooling of the air as it conducts some of its heat to the ground. Thus air tends to have the same temperature as the surface with which it is in contact. Air is a poor conductor, however, and the actual conduction during the course of a day or night affects only two or three feet of air. Wind and turbulence, however, bring fresh air in contact with the surfaces and distribute the warmed or cooled air to a considerable height.

Air temperatures.—For this reason the temperature of the air lags behind that of the earth and changes less; the air is not so warm as the land, in the sunshine, nor so cool under radiation conditions. This applies to air locally heated or cooled, not to warm or cold air that may be brought in from other regions. The poor conductivity of the air and its slow loss of heat by radiation explain why frosts sometimes occur when the general air temperature is considerably above freezing. The grass, the paving, and other surfaces where frost forms, are colder than the mass of air a few feet above them. It is clear also why a thermometer must be sheltered from radiation, direct or reflected, if it is to assume by conduction the temperature of the surrounding air.

The question, "What is the temperature in the sun?" meaning in sunshine, has no answer. Each different object exposed to the sun's rays absorbs radiation differently and takes on a different temperature. Black objects become warmer than light-colored ones, and dry ones warmer than moist ones. When a black-bulb thermometer, that is, a thermometer with a large bulb coated with lampblack, is exposed to solar radiation, it often has a temperature 60°F . or 70°F . higher than that of the surrounding air. A piece of black fur exposed to the sun's rays in winter in the Alps reached a temperature of 140° when the air temperature was 41° . On the other hand, such an object gets much colder than the air at night. It is the temperature of the air, and not of absorbing and radiating solid bodies that is of primary concern in discussing the weather. What happens to solar radiation reaching the earth's atmosphere is illustrated in Fig. 41, after a figure by Dines in his dis-

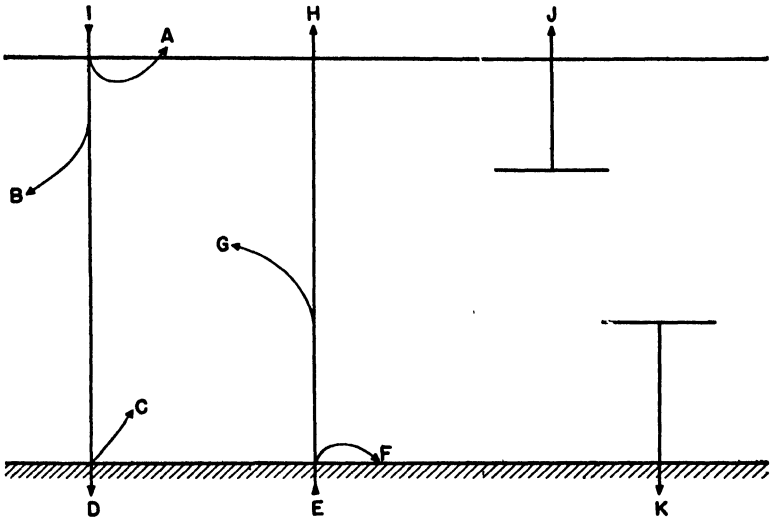

Fig. 41. Interchange of Heat in the Air (After W. H. Dines). Of the incoming radiation, *I*, a portion, *A*, is turned back by the atmosphere; another portion, *B*, is absorbed in the air; but the greater part reaches the earth, where some of it, *C*, is reflected, and the remainder, *D*, is absorbed. Of the outbound earth radiation, *E*, there is a reflected part, *F*, an absorbed part, *G*, and an escaping part, *H*. Finally, the air radiates some heat to space, *J*, and some to the earth, *K*.

cussion of the heat balance of the atmosphere. (See bibliography.) Presumably, the average outgo of radiant energy by these processes is equal to the average income; otherwise the earth and the atmosphere would be growing progressively warmer or colder, and such is not perceptibly the case.

Earth temperatures.—As previously stated, the heating of a land surface by insolation is confined to a thin surface layer. This is because land is a poor conductor. Heat is conducted downward so slowly that the diurnal change of temperature ordinarily penetrates but two or three feet into the soil. Before it has reached that depth, night has arrived, and the surface is cooling. The annual variation probably disappears in all latitudes at a depth of something like 100 feet. The amplitude of the change in this surface layer diminishes rapidly with depth and depends largely upon the seasonal differences in air temperature. The temperatures at 100 feet below the surface vary with the latitude, being dependent on the mean annual temperatures of the air at the surface. At greater depths, the temperature of the earth increases slowly but not uniformly. In the oceans, water temperatures diminish slowly beyond a depth of about 2,500 feet toward a nearly uniform value of 32°F. to 35°F. in all latitudes.

Convection

Conduction and the absorption and emission of radiation are the three processes originating temperature changes, but another method of transferring heat is of great importance in relation to the temperature and behavior of the air. This is *convection*, the transfer of heat by the bodily movement of the substance containing the heat. As thus defined, the carrying of a heated iron from one place to another, or the movement of air as it strikes a hillside and is forced upward are examples of convection. But as the term is generally used in meteorology, and as it will be used here, convection means *thermal convection*, that is, movement resulting from temperature differences. Such con-

vectional movements occur in liquids and gases but not in solids.

Convection in a liquid.—If a test tube is filled with water, and a flame is applied near the top, the water at the top may be brought to the boiling point while that at the bottom is relatively cool. In this case, the lower water is

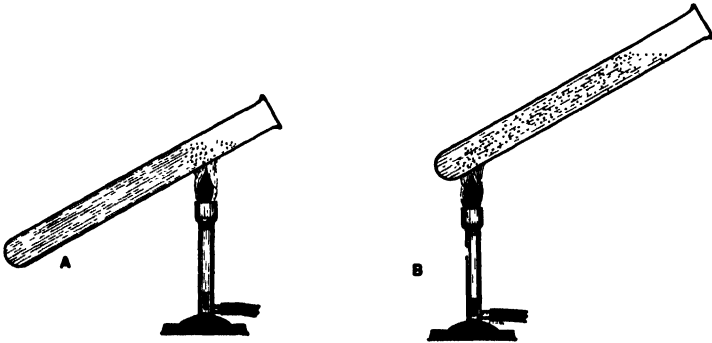

Fig. 42. Transfer of Heat by Convection. *A*, water heated at the top; lower portion remains cool. *B*, water heated at the bottom; all becomes nearly equally heated.

heated only by conduction. If the flame is applied near the bottom of the tube, the heated water expands and is displaced by the cooler, denser liquid above it, setting up a *convictional circulation*, in which heat is transferred by the movement of the water.

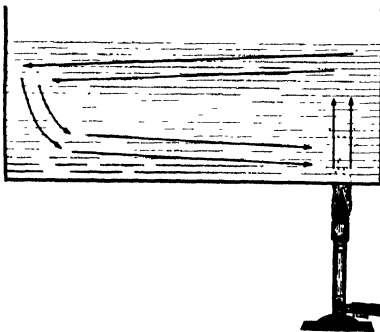

Fig. 43. Convectional Circulation in a Liquid Heated at the Bottom on One Side.

Thus, the entire mass becomes heated to the boiling point at nearly the same time. Fig. 43 illustrates a convectional circulation set up in a vessel of water heated at the bottom over a small part of its area.

Convection in the air.—Gases move even more freely than liquids and likewise expand when heated,

thereby becoming lighter than before, volume for volume. Familiar examples of convection in the air on a small scale are the draft up a chimney and the rising of air over a heated radiator. In these cases air is warmed at the bottom, and colder, heavier air pushes it upward out of the lowest place. The effectiveness of a warm-air furnace in heating a house depends upon this method of transferring heat. We have noted that, while the earth's surface is heated by absorption of insolation, it is for many reasons very unequally heated, and that the lower air is heated by conduction and likewise unequally heated. We should therefore expect to find convectional currents, involving downward and upward movements of the air, between areas of contrasting temperatures, as, for example, between the oceans and the continents, and on a large scale between equatorial and polar regions. It will be seen, as we proceed, that such movements are of primary importance in the study of the atmosphere.

Adiabatic changes in temperature.—A very important difference between convection in liquids and in the air must be noted. Liquids are nearly incompressible, but the lower air is made dense by the weight of the air above it. When air ascends, it rises above some of this mass, the pressure on it decreases, and the gases expand according to Boyle's law. Expansion against pressure constitutes work in the physical sense, and uses energy. The energy expended in this process is heat energy, and the effect is to cool the air. Similarly the gases in a gasoline engine do work when they expand against the piston, and they lose some of their heat in doing so.

Ascending air cools as it expands under decreasing pressure, and descending air is warmed by compression as it comes into regions of greater pressure. Note that these temperature changes are not related to any transfer of heat to or from the air. The air becomes cooler or warmer without any conduction or radiation, and purely as a dynamic result of the change of pressure upon it. Such changes in temperature are called *adiabatic* changes, the word imply-

ing "without transfer of heat." It may be shown by a physical discussion of the properties of gases that when dry air rises above the ground surface, the dynamic cooling due to expansion is at the nearly uniform rate of 5.5°F. per 1,000 feet, or 1°C. per 100 meters. The rate of warming with descent is the same. This is the *adiabatic rate* for dry air.

When there is considerable moisture present in rising air, the cooling caused by rising and expansion may result in saturation and then in condensation of some of the water vapor. The effect of the latent heat of condensation thus released is to retard the cooling. Thereafter, while condensation continues, rising air cools at a *retarded adiabatic rate*. This retarded rate of cooling, also called *saturated* or *wet adiabatic rate*, is not so nearly constant as is the dry adiabatic rate, but depends upon the temperature and pressure, and upon whether the condensed moisture is carried along with the rising air or drops out of it. Under changing conditions the rate varies from about 0.4°C. to nearly 1°C. per 100 meters. A convenient value to use for calculation in the absence of specific data is 0.6°C. per 100 meters, or 3.2°F. per 1,000 feet.

Descending air is dynamically warmed by compression. The possible moisture content is thereby increased, and hence there will be no condensation, but, on the contrary, there will be evaporation if liquid water is present in such air. This will result in a retarded warming of the descending air equal to the retarded cooling on ascent if all the condensed moisture has remained in the air. If it has all been precipitated, the descending air warms at the dry adiabatic rate. Usually, when condensation has occurred, some condensed moisture is present when the air begins its descent, but this soon disappears as the temperature rises, and for the remainder of its descent the air is unsaturated.

Note that adiabatic changes occur only when air is actually expanding or being compressed, and that they occur without any heat being either added to or taken from the

air. Let us consider whether such a condition ever occurs in nature. Take, for example, a large mass of rising air, such as that which precedes the formation of a cumulus cloud. A small part near the outer surface of the rising mass may have its temperature affected by mixing with the surrounding air; also near the outer surface there is some interchange of heat by radiation and absorption. But air is a poor conductor and a poor absorber, and these modifications do not reach any great distance into the interior of the rising column. Much the greater portion of the ascending air is subject to no appreciable loss or gain of heat to or from outside sources. Hence, its changes in temperature are essentially adiabatic, the result of expansion under decreased pressure, and are treated as such for practical purposes in interpreting the behavior of the atmosphere. The dotted lines marked A in Fig. 44 represent the dry

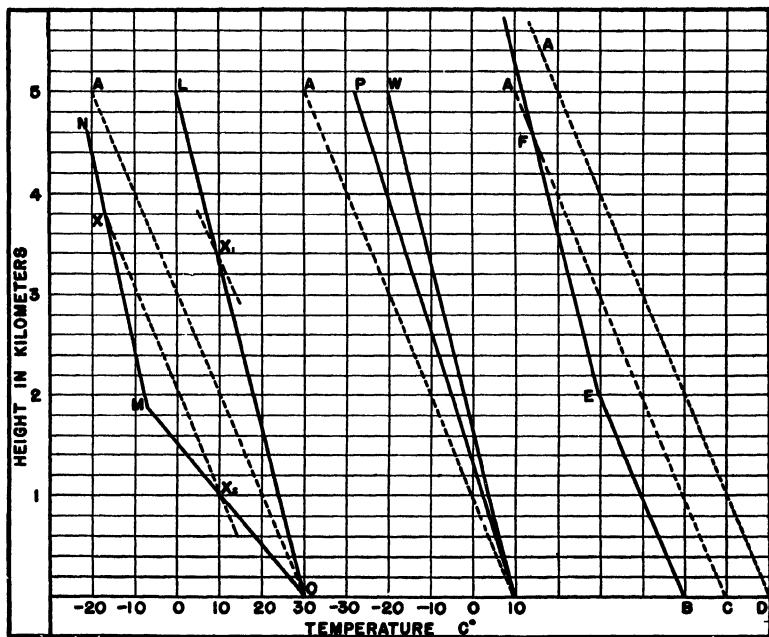

Fig. 44. Adiabatic Changes of Temperature.

adiabatic rate of change of temperature with elevation, showing a fall of 10°C . for each kilometer of increased height, and the line, W , represents a saturated adiabatic rate of 6°C . per kilometer.

Potential temperature.—Suppose a quantity of dry air at or above the surface of the earth and subject to a pressure of 1,000 millibars has a temperature of 70°F . If it now rises 1,000 feet, remains unsaturated, and cools at the dry adiabatic rate of change, its temperature will be $70 - 5.5 = 64.5^{\circ}\text{F}$. If it then descends to its original level where the pressure is 1,000 millibars and warms adiabatically, it will return to its original temperature of 70°F . No matter how far this quantity of dry air rises or descends, or what pressure changes it undergoes, it will always return to a temperature of 70° when it returns to a pressure of 1,000 millibars, provided it remains unsaturated and is subject only to dynamic influences. Whatever its actual temperature in any position, its potential temperature is 70° . In general terms, *potential temperature* is defined as the temperature which a quantity of air would have if brought by adiabatic changes to a pressure of 1,000 millibars. Potential temperature is the actual temperature reduced to a standard pressure. Changes of elevation result in changes in the actual temperature but make no difference in the potential temperature of dry air.

Suppose, now, that the air, having risen 1,000 feet and reached a temperature of 64.5°F ., becomes saturated at that point, but continues to rise another 1,000 feet, with condensation and precipitation occurring. During the second thousand feet of rise, it will have cooled only 3.2° , and at the top will have reached a temperature of 61.3°F . If it now descends to its original level, warming all the way at the dry adiabatic rate, when it reaches the standard pressure its temperature will be $61.3 + 11.0 = 72.3^{\circ}\text{F}$. instead of the 70° at which it started. We see that the potential temperature may be increased by adiabatic processes, when these involve condensation.

Again, let a quantity of air, starting at the standard pressure of 1,000 millibars, rise until it has lost all its moisture, cooling first at the dry adiabatic and later at a retarded rate, and absorbing the heat released by condensation. This process is equivalent to adding to the air the latent heat of condensation of all its moisture. Let this completely dry air then descend to the standard pressure. The temperature which it then assumes is called its *equivalent potential temperature* and can be calculated, when the original temperature and humidity are known.

The potential temperature of a given mass of air is unchanged by dry adiabatic processes. The equivalent potential temperature remains the same even though the vertical movements involve condensation and precipitation. It can be changed only by the process of evaporation and by the loss or gain of heat to or from outside sources. In Fig. 44, if air at a temperature B , and under a pressure of 1,000 millibars, rises and cools at the dry adiabatic rate to E , its potential temperature is still B . If it then cools at a retarded rate to F , its potential temperature becomes C . If it continues to rise until all its moisture is condensed and the latent heat all absorbed, and then returns adiabatically to the standard pressure, its temperature will be D , and this is the equivalent potential temperature of this air at any elevation.

Lapse Rates and Stability

We have seen that ascending or descending air changes temperature at a definite rate as a result of the changing pressure upon it. This does not mean that the overlying air always grows colder at these rates. There are many reasons why the temperature of the air above a given area at a given time should only rarely vary according to the adiabatic rate of change. In the first place, air is not always rising or falling, and therefore not always changing adiabatically. Second, air is constantly gaining and losing heat by radiation, absorption, and conduction; and hori-

zontal movements bring warm or cold air from other sources. For these reasons the actual vertical distribution of temperature is frequently quite different from that caused by adiabatic processes.

The actual change of temperature with elevation, whatever it may be, is called the *lapse rate* of the air. *Vertical temperature gradient* expresses the same idea, but "lapse rate" is a shorter and more convenient term. Strictly speaking, the lapse rate is the rate at which the air grows colder with increased height; that is, in case the air gets warmer, the rate is negative. The word lapse means in this connection the gradual passing from a higher to a lower temperature. Lapse rate is the general term; adiabatic and saturated adiabatic changes are particular lapse rates occurring under special conditions.

Variability of lapse rates.—During the past fifty years a great many records of the temperature of the air within a few miles of the surface of the earth have been obtained by means of balloons and kites, and, more recently, by airplanes. The actual lapse rates found in different individual ascents have great variability from day to day and at different levels in the atmosphere on the same day, especially in the first two miles (3 km.). Beyond two or three miles (3–5 km.), the rates are apt to be more nearly uniform. That is to say, the temperature of the air below two or three miles changes very irregularly, influenced by irregular wind movements from various sources. These movements sometimes cause a temporary lapse rate that is greater than the adiabatic rate, and, on the other hand, the lapse rate is often less than the retarded adiabatic. These irregularities are illustrated in curves 1 to 5, Fig. 45, which are drawn from records made by recording instruments carried aloft by kites or balloons, and represent the conditions existing at a specific time.

In some cases, instead of decreasing with altitude, the temperature actually increases, as shown at several places in the curves just mentioned. Such a condition is called

an *inversion of temperature*, or simply an *inversion*. On a calm, clear night, the air within ten or twenty feet of the ground, because of its contact with the cold earth, often becomes colder than the air higher up. Inversions frequently occur in this way, but they also occur at higher levels, by reason of winds from different directions and of differing temperatures, as shown in curve 1, between 2,400 and 2,750 meters. In the case of an inversion, the lapse rate is negative.

Observations of air temperatures aloft have now been

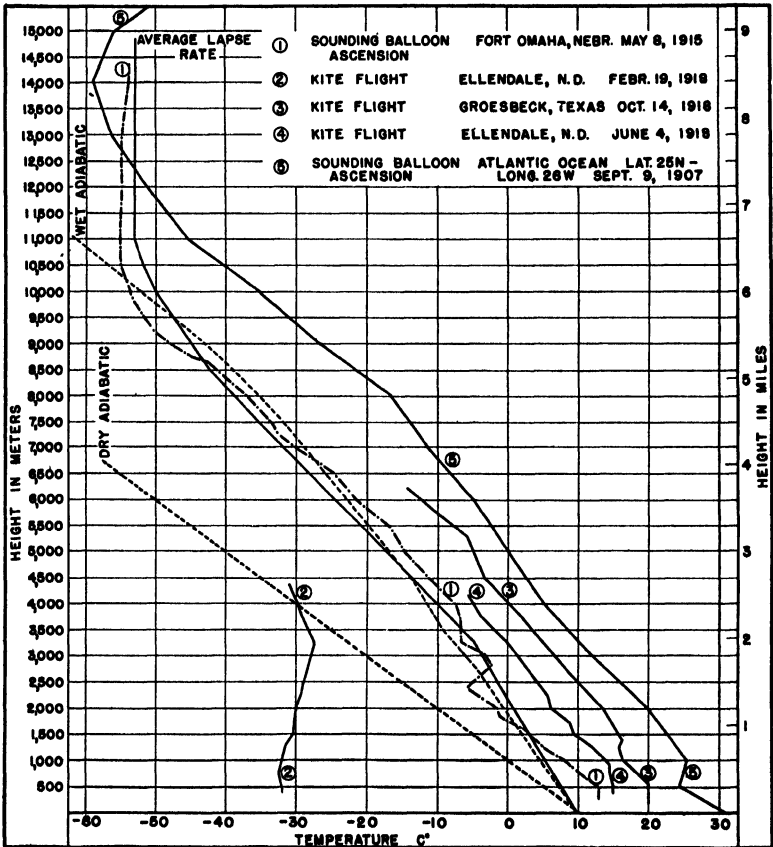

Fig. 45. Lapse Rates.

made in many parts of the world and are sufficiently numerous to establish a fairly definite normal or average value. This *average lapse rate* is found to be about 3.2°F. per 1,000 feet (0.6°C. per 100 m.). Note that it has the same value as that used for the wet adiabatic rate. The result of all the complex interchanges of heat in the air is a balanced condition about equal to that produced by adiabatic changes retarded by condensation. The average lapse rate appears to be about the same in all parts of the world, but varies slightly with changing pressure at the surface and with the change of seasons. The average lapse rate is less when the pressure is high than when it is low, and less in winter than in summer. It is somewhat less in the first 2 kilometers (1.2 miles) than between that height and about 10 kilometers (6.2 miles).

The average lapse rate and the dry and saturated adiabats are indicated in Fig. 45, by the lines beginning at a temperature of 10°C. Note how the average rate, which is obtained by observation, varies from the wet adiabatic at different elevations, being less in the first two kilometers, greater up to about eight kilometers, and then less than the saturated adiabatic again above eight kilometers, but having about the same average value in the first 10 kilometers.

Stability.—The word *stability* is used in meteorology to indicate a condition of equilibrium, as that phrase is used in physics. A ruler lying flat on the table is in stable equilibrium; if one end is raised and then released, it returns to its original position. A ruler standing on one end is in unstable equilibrium; if the upper end is moved slightly, the ruler does not return to its former position, but takes a more stable position. Let us examine the effect of various lapse rates upon the stability of the air, upon its tendency to move up or down.

It is evident that when a certain mass of air is heavier than the surrounding air, it will tend to fall or settle downward; if lighter than the surrounding air, it will be pushed upward. If the temperature of the air is exactly the same

throughout the first 1,000 feet above the ground, for instance, the air at the bottom is a little denser because of the added pressure upon it, and hence a little heavier, volume for volume, than that at the top. Because it is heavier, it tends to stay at the bottom; but suppose by some means we force a certain portion of it to rise through the surrounding air. This rising portion cools at the adiabatic rate, provided that it does not reach its dew point. Therefore, at any level to which the rising portion attains within this assumed layer of equal temperature, it is colder and heavier than the air around it. When the outside force which caused it to rise is no longer effective, it sinks back to the surface. The air tends to return to its original position under such conditions, and is therefore said to be *stable* or in stable equilibrium. The case of inversion, in which warm air overlies a surface layer of cold air, is evidently an example of marked stability.

Instead of assuming that the temperature is the same throughout or increases upward, let us assume that it falls with elevation, but that the rate of fall as indicated by the line *OL* in Fig. 44, is less than the adiabatic rate. Any portion of this air having a vertical movement, starting at x_1 , for example, will change its temperature at the adiabatic rate. If started upward it will soon become colder than the surrounding air, and settle back to its original position. If pushed downward, it will warm more rapidly and become lighter than the air around it and move upward to its former place. Hence this air is stable and any air is stable in which the actual temperatures are higher than they would be if air rose from the surface and cooled adiabatically. The general rule may be stated thus: *Air is stable when its lapse rate is less than the adiabatic rate.* Such air stays in position or returns to its position if forced out of it. Thermal convection is not possible so long as the air remains in this condition.

Instability.—If the lapse rate, as indicated by the line *OM*, Fig. 44, is greater than the adiabatic, air starting at

any point, x_2 , and moving upward, becomes progressively warmer than its surroundings and therefore continues to rise indefinitely as long as the given lapse rate of the surrounding air continues. Likewise, air starting downward at x_2 becomes progressively denser than the surrounding air, and continues downward to the earth's surface. This is a case of instability; a little push in either direction sets the air moving indefinitely. The push is frequently given by a change in temperature. If air is heated near the surface and starts to rise, it will continue to rise as long as it is surrounded by air having a temperature gradient greater than the adiabatic. *Air is unstable when its lapse rate is greater than the dry adiabatic rate.* This condition is favorable to convection. The maximum possible lapse rate is one in which the air gets colder so rapidly as to offset the tendency to expansion due to decreased pressure, and thus to give the air a constant density in the vertical. This requires a fall of temperature of 19°F. per 1,000 feet of elevation, and is a very unstable condition. Any little impetus either up or down will start the air moving rapidly in the direction of the impetus.

If the lapse rate changes at the point M , and from there on becomes MN , the air is stable between M and N , and air which started to rise at x_2 , will reach a point x , where it has the same temperature as the surrounding air, and it will go no farther. Such a change in the lapse rate may be occasioned by a warm current in the upper air, and such a current limits convection. Convection will stop at, or somewhat above, the bottom of the warm current, and if the air has not already been cooled to its dew point, there will be no condensation, no clouds, and no rain. Conversely, if there is a cold current in the upper air, convection will continue through it, and the rising air will probably cool below its dew point, resulting in cloudiness and rain. A stable condition of the atmosphere, therefore, favors fair weather; an unstable condition is conducive to cloudiness and rain

Conditional instability.—The illustrations of stability and instability used in the two preceding paragraphs assumed that the rising air did not reach its dew point. After condensation begins, rising air cools at a retarded adiabatic rate, represented by the line *W*, and it is that rate rather than the dry adiabatic which then determines stability or instability. *Air in which moisture is condensing is unstable if the lapse rate is greater than the retarded adiabatic rate, and stable if it is less.*

The condition of the atmosphere is at times such that its lapse rate may be represented by the line *P*, Fig. 44, lying between *A* and *W*. The rate is less than the dry and greater than the wet adiabatic. Such air is therefore stable when dry and unstable when condensation is occurring in it, and is said to be in a state of *conditional instability*. Whether it is stable or unstable is conditioned by whether or not it has been cooled below its dew point. Condensation, therefore, often makes convection possible when it would not otherwise be so, and permits it to extend to greater heights than it otherwise would. When the air is definitely unstable, that is, when the lapse rate is greater than the dry adiabatic rate, condensation makes convection more active by increasing the difference between the temperature of the rising air and that of the surrounding air.

Turbulence in relation to lapse rates.—It is not always temperature difference that supplies the initial impulse to vertical movements of air. The atmosphere, especially within a few hundred feet of the earth's surface, but to some extent at all elevations, is turbulent, and the many small irregular movements and eddies have vertical as well as horizontal components of motion. If the air is unstable, turbulence is sufficient to start convection currents and result in an upward transfer of heat. If the lapse rate is less than the adiabatic, the vertical movements started by turbulence are checked and damped. Hence turbulence is more pronounced in unstable air than in stable air. This is illustrated by the usual difference in the gustiness of the

wind in the daytime and at night. By day there is instability and convection, favoring gustiness and increased movement; by night the cooling of the surface layers favors stability and decreased movement.

Latent instability, convective instability, subsidence.—A given mass of air may be stable as it stands and yet a sample may become unstable if forced upward through the mass. The lapse rate and moisture content of the mass may be such that condensation begins in the rising particle, although there is no condensed moisture in the mass as a whole. If the sample is raised adiabatically beyond the level at which condensation begins, it cools more slowly than the air around it. When it has been lifted to a height where it is warmer than its surroundings, it becomes unstable and rises freely without outside force. This is a condition of *latent instability*. The air is stable for small displacements that do not cause condensation but unstable when it rises above its condensation level.

Similarly, an entire layer of stable air may become unstable by lifting. The distribution of temperature and moisture must be such that the layer becomes saturated as it rises, and such that the equivalent potential temperature decreases upward. As such a layer rises, it will cool at the dry adiabatic rate at first and then at the wet rate, but the final lapse rate between top and bottom, under the conditions assumed, is greater than the wet adiabatic. The air is therefore unstable. Layers of this nature, which though originally stable become unstable on rising, are *convectively unstable*, or in a condition of *convective instability*. In contrast, any subsiding layer of air has a decreasing lapse rate and an increasing stability. As the base of the layer approaches the earth, its downward motion is more and more impeded, the layer spreads out and becomes thinner. Hence, the top descends farther than the bottom and is warmed, adiabatically, more than the bottom. This results in a smaller difference in temperature between top and bottom and a smaller lapse rate.

Subsidence of a layer of air therefore increases its stability, and may even cause a temperature inversion.

Atmospheric Layers

Until recently it was supposed that the air above the first few miles grew thinner and colder by continuous gradation until it gradually merged into outer space. No change in characteristics, except perhaps for the proportions of its constituent gases, was suspected. It was assumed that this high air had little influence on terrestrial affairs and presented few problems of scientific interest or practical concern. Among the most important advances in meteorology since the beginning of the twentieth century has been the discovery that the upper air has a complicated physical structure, with many theoretical and practical bearings. In particular, upper air exploration has shown that the atmosphere has some structural resemblance to a house of several stories; it is divided into layers, or strata, and each layer has its own peculiar features and behavior.

Stratosphere and troposphere.—The first evidence of stratification in the upper air came with the discovery of what is now known as the stratosphere, which Sir Napier Shaw calls, “the most surprising discovery in the whole history of meteorology.” It has been noted that the normal lapse rate is about the same in all parts of the world, and, beyond an elevation of about two miles, becomes quite regular. It was natural to assume that this condition continued upward indefinitely, but the accumulation of data from sounding balloons enabled Teisserenc de Bort and Assman to demonstrate, between 1899 and 1902, that the air ceases to become colder with elevation at a certain fairly sharp limit in the upper air, at an average elevation of about 7 miles (11 km.). From this surface upward for a distance of a few miles, as has been confirmed by many subsequent observations, the temperature remains practically the same, or increases slightly; the lapse rate of the air at these elevations is zero or negative. The region is

therefore nearly isothermal in a vertical plane, and was first known as the *isothermal region*; but it is now called the *stratosphere*. It is evident that the air in this layer of the atmosphere is in stable equilibrium; there can be no convection through it.

The region between the earth and the stratosphere, where there are frequent instability and convection currents, is known as the *troposphere*. The prefix *tropo* carries the meaning of a turning or overturning of the air, such as occurs in convectional movements. The same root occurs in the word *tropic*. The boundary surface between the two regions, the level at which the troposphere ceases and the stratosphere begins, is the *tropopause*. After the discovery of the stratosphere, Humphreys in America and Gold in England offered, at about the same time, physical explanations for the existence of such a region. The explanations are technical and not entirely satisfactory, because as yet too little is known about the absorption and radiation of energy in the thin air at such elevations. All that need be said here is that in the stratosphere a balance between absorbed and emitted radiation is somehow maintained.

Height of tropopause, and temperatures in the lower stratosphere.—In the temperate latitudes of Europe, where records were first obtained and studied, the stratosphere was found to begin at a height of about 7 miles. With the accumulation of records from other parts of the world, it is now known that the height of the tropopause varies with latitude. The height is about 10.6 miles (17 km.) in equatorial regions, from which it gradually decreases toward the poles, both north and south, descending in polar regions to an elevation of only 3 or 4 miles (5–7 km.), and possibly less. In addition to this marked change in height with latitude, there are smaller changes related to the seasons and to barometric pressure at the surface. The tropopause is higher in summer than in winter and higher when the surface pressure is high than when it is low. In Fig. 45, curve 1, which was obtained at about latitude 41°

north, shows the beginning of the stratosphere at 10,500 meters, at a temperature of -53°C ., and a very slow increase of temperature up to 14,500 meters. In curve 5, obtained at latitude 25° north, the stratosphere begins at 14,000 meters and a temperature of -59°C .; above that height the temperature rises noticeably.

Although vertical surfaces in the lower portion of the stratosphere are nearly isothermal, it is by no means true that the stratosphere is everywhere of the same temperature. The temperatures at the same elevation in different parts of the world vary widely. In equatorial regions the normal lapse rate continues to a height of about 10 miles, until the temperature has fallen to -100°F . or -110°F . A temperature of -134°F . was registered at a height of 10 miles, above Batavia, Java. In polar regions the temperature decreases to a height of only 3 or 4 miles above the earth and falls to -30°F . or -40°F . In middle latitudes the temperature at the tropopause, about 7 miles above the surface, is about -60°F . The higher the tropopause, the longer the lapse of temperature continues, and the lower is the temperature of the stratosphere. Hence, at heights of 4 miles or more, it is colder over the equator than over the poles. This is true at least in summer. In winter the temperature at these heights in polar regions may be lower because of radiation cooling in the absence of insolation. There are movements of air in the stratosphere, perhaps the result of the temperature differences just mentioned, but in passing from the troposphere to the stratosphere it has usually been found that the winds decrease in velocity fairly rapidly, without changing their direction.

Temperatures in the upper stratosphere.—The stratosphere temperatures just given are for its lower portion, in which actual measurements have been obtained by recording instruments. Certain phenomena studied in recent years have led to the conclusion that slightly above 10 miles (16 km.) the temperature begins to increase slowly and

continues that increase to a height of about 30 miles (about 50 km.), where it becomes comparable with temperatures at the earth's surface. Some facts and calculations indicate that the temperature may be as high as 80°F. and fairly constant at elevations in the neighborhood of 100 miles.

That there is an increase in the temperature of the upper air was first suggested by a study of meteors, and has been confirmed by investigations of the behavior of sound waves. A large explosion may be heard for a distance of 60 to 100 miles in all directions from its source because of the direct travel of the sound waves through the lower air. Beyond this area there is a belt about 125 miles wide in which the sound cannot be heard. Then, strangely enough, the sound again becomes audible in a zone of considerable width. This phenomenon may even be repeated, resulting in another zone of audibility beyond a second zone of silence. These outer zones of audibility can be accounted for only when it is assumed that the sound waves are refracted or reflected in the upper air and thus returned to the earth. Since sound travels faster in warm air than in cold, an assumption of increasing temperature in the upper stratosphere accounts for this bending back of the waves. The greatest height from which such refracted sound waves appear to come is about 25 miles (40 km.).

Ozone layer.—A line of investigation entirely independent of sound waves has afforded at least a partial explanation of the presence of warm air in the upper stratosphere. Spectroscopic observations have shown that there exists in the atmosphere a total quantity of ozone which, if concentrated at the surface of the earth under normal atmospheric pressure, would form a layer only one eighth of an inch (3 mm.) thick. The amount increases from equator to poles. It is greatest in spring and least in autumn. Most of it occurs between the heights of 12 and 31 miles (20 and 50 km.), and forms what is called the *ozone layer*. The stratosphere balloon, *Explorer II*, in its flight over South Dakota, in 1935, to a height of 13.7 miles

(22 km.), appears to have penetrated well into the ozone layer, which commenced more sharply than previously determined. Some ozone occurs in the lower atmosphere, but its amount is extremely small. It is well known that ozone absorbs much more heat, especially in the ultra-violet portion of the spectrum, than the other permanent gases of the air. This ozone layer then, may account for increasing temperatures at heights of 13 to 30 miles, and its height obtained from spectroscopic observations agrees with the height of the sound-reflecting layer as calculated from audibility observations.

The ozone layer acts as a filter, absorbing ultra-violet radiation. If it were not there, the full complement of ultra-violet reaching us from the sun would burn our skins, blind our eyes, and result in our destruction. But if the layer were thicker and absorbed all of the ultra-violet, we should also suffer, for some of this short-wave radiation is necessary to health and even to life. This slight and rarefied layer of ozone furnishes an excellent example of a nice adjustment of nature, an adjustment necessary to our life, but entirely unsuspected until very recently.

Ionized layers.—At still greater elevations than that of the ozone layer, there are other interesting and significant strata in the atmosphere. Much information about these layers has been given by the development of radio communication. Since radio waves are of the same nature as solar radiation, they spread out, with the velocity of light, in straight lines from their source. After the first use of wireless transmission, physicists calculated that radio waves could not be detected at distances greater than 178 miles. Their calculations were doubtless correct on the assumption that the waves would travel in a direct course from the source. They were unaware of any condition that would change the course of the waves, but we now know that radio waves travel entirely around the globe within the atmosphere. The only way they can be kept within the atmosphere and made to follow a curved path is by being turned

back to the earth, as we have seen that sound waves are. An upper-air region of high electrical conductivity would so reflect the radio waves. Some of the phenomena connected with the earth's magnetic field had previously suggested to investigators the existence of a conducting layer in the high atmosphere, but it has been the study of radio waves, since 1915, that has given definite proof of not only one but several such layers.

High electrical conductivity is due to the presence of ions in the upper air. Ions are electrified, gaseous atoms, and are produced in the gases of the air by solar radiation. At first it was supposed that the ions occurred in a single layer at a height of about 70 miles (113 km.), and this was named the Heaviside-Kennelly layer, taking the names of the men who first proved its existence. Further study and accurate timing of radio waves of different lengths have shown that there are at least three layers, and these are referred to as the *D*, *E*, and *F* layers. The lowest is the *D* layer; it is about 25 to 30 miles (40–50 km.) in elevation and turns back only the longest radio waves. *E* is the middle or Heaviside-Kennelly layer, now often called the Heaviside layer, which varies between 45 and 90 miles (70–150 km.), averaging about 70 miles, in distance from the earth, and which reflects waves of 300 to 400 meters' length. The *F* layer, also called the Appleton layer, and sometimes divided into two parts, *F*₁ and *F*₂, begins about 100 miles (161 km.) above the earth and continues to 220 miles (354 km.). It returns still shorter waves, but some of the shortest escape to space.

Without these conducting layers, long distance radio communication would be impossible. The effective heights of the layers vary with the time of day and the time of year; they are lower in summer and by day, and higher in winter and at night; in particular, there is often an abrupt decrease in their height at about sunrise. These changes are due to the effect of sunshine upon the ionization of the atmosphere. The statements made with reference to the

height and concentration of the ozone and ionized layers are tentative and subject to revision.

The name *stratosphere* is now often confined to that portion of the air between the tropopause and the ozone layer. The latter is then called the *ozonosphere*, and the region of the ionized layers, which is also the region of auroral displays, is given the name of *ionosphere*. The whole subject is new, and additional data are constantly accumulating, but the existence of a stratified atmospheric structure of the character indicated appears to be firmly established. Fig. 46 is a diagrammatic representation of

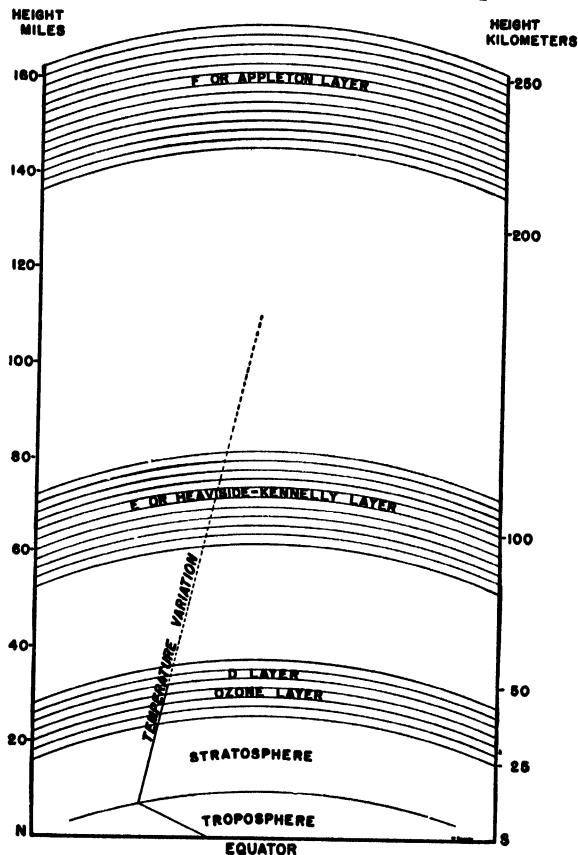

Fig. 46. Layers of the Atmosphere.

these layers or spheres. The atmosphere in its entirety is not a homogeneous mass, but a structure of several layers or spheres of a significance and a physical complexity unsuspected until very recently. We live in the lowest of these spheres, which in itself presents many physical problems that still baffle complete elucidation.

Summary

“Radiation is caused by the fact that the atom becomes excited—the phrase is a properly scientific one—and one of its electrons jumps for one thrilling ten-millionth of a second beyond its proper orbit, and then returns to its place again.”¹ Radiation so produced moves through space, and to a greater or less extent through solid matter, with the “velocity of light,” exhibiting the properties of waves of varying length and frequency. The solar radiation (insolation) absorbed at the surface of the earth is the source of the earth’s energy. The rate at which radiation is emitted by the sun is not altogether constant, but the amount received at a given place on the earth depends very largely on the elevation of the sun, the length of the day, and the clearness of the air.

Very little insolation is absorbed by the air, and that mainly by its water vapor and dust content. Much is absorbed in a thin layer of the earth’s surface, with consequent rapid heating in sunshine. Insolation penetrates a water surface deeply and its energy is expended in warming a large volume and in evaporating some of the water. Large bodies of water therefore respond more slowly and less completely to differences in insolation. They also radiate their own heat more slowly.

Temperature differences in air, land, and water, resulting in the main from differences in absorption and radiation, tend to disappear by the process of conduction of heat. In this way the air that comes in contact with the earth and

¹ Dorothy Fisk, *Exploring the Upper Atmosphere*, p. 74, Oxford Univ. Press, New York, 1934.

objects on the earth is warmed and cooled and tends to assume the temperature of the surface over which it lies or moves. Above the surface, the most important thermal influence is the process of convection resulting from temperature differences. Vertical movements of the air are attended by dynamic cooling on ascent and warming on descent, because of changing pressure and consequent expansion or compression. If there is no transfer of heat to or from the rising air, the change of temperature is adiabatic. In dry air the change is about 5.3°F . per 1,000 feet. This rate is reduced about one half after condensation begins.

When dry air rises and subsides adiabatically, the temperature that it assumes under a given pressure (its potential temperature) remains constant; but if the cooling on ascent is partly at a saturated adiabatic rate, and the warming on descent is adiabatic, the potential temperature of the air is increased. The amount of increase will depend on the amount of condensation, and if all the moisture is condensed, there can be no further change of potential temperature, and the air will then have a definite temperature under standard pressure. This is the equivalent potential temperature.

The actual lapse rate of temperature in a given mass of air often differs widely from the adiabatic rate of cooling of rising air, at times to the extent of an increase in temperature with elevation. Such inversions often occur near the earth at night, when the land cools by radiating its heat, and the lower air cools by conduction. The air is stable and will remain in place when its potential temperature increases with elevation, that is, when its temperature decreases less rapidly than rising air would cool adiabatically. It is in a condition of instability when its potential temperature decreases with elevation, in other words, when its temperature falls more rapidly than the adiabatic rate. Instability permits convection and contributes to turbulence.

An average lapse rate of about 3.2°F . per 1,000 feet pre-

vails as we ascend in the air, until, at heights varying between 3 and 11 miles, the fall of temperature ceases rather abruptly. Beyond the height at which this change occurs, the temperature of the air remains nearly constant for a few miles and then perhaps gradually increases to a height of about 30 miles. The atmosphere is thus composed of two distinct layers, the turbulent troposphere in which our weather occurs, and above it, the more orderly stratosphere. The height at which the stratosphere begins, the height of the tropopause, varies with the latitude and to a less extent with the season of the year and the barometric pressure in the lower air. It is greatest over equatorial regions and least over polar regions.

Temperatures in the lower stratosphere are inversely related to the height of the tropopause; they are lowest over the equator and highest over the poles. The upper stratosphere is not entirely homogeneous but contains a layer of ozone, which absorbs ultra-violet radiation, at an elevation of 15 to 30 miles, and several ionized layers, which return the waves used in radio transmission to the earth, at heights of from 25 to more than 200 miles.

Problems

1. Assuming the air to have the average lapse rate and a surface temperature of 60°F ., if a certain mass of dry air at the surface is heated to 72°F ., how high will it rise and what will be its temperature at that height?

2. Assume that the maximum temperature on a quiet summer afternoon will be the temperature at which the air becomes unstable, as indicated by the temperatures at the surface and at 3,600 feet;

a. What will be the maximum temperature if the air at 3,600 feet has a temperature of 70°F .?

b. If the temperature at 3,600 feet is 45°F .?

3. Let air having a temperature of 15°C . at the surface of the earth rise 4 kilometers, with condensation occurring during the last 2 kilometers of the rise. What is its potential temperature at the surface and after it has risen to 4 kilometers, under the following conditions:

- a. When the pressure is 1,000 millibars at the surface?
- b. When the pressure is 1,000 millibars at 300 meters' elevation?

4. On a certain day air has the following temperatures at the elevations given: 50° F. at the surface; 42° at 1,000 feet; 45° at 2,000 feet; 41° at 3,000 feet; 38° at 4,000 feet.

- a. Plot the lapse rate.
- b. What part of the air is stable?
- c. What part is unstable?
- d. If the surface air be heated 10°, how high will it rise if no condensation occurs?
- e. If the air at 4,000 feet be cooled 10°, how far will it descend?

5. A kite flight at Drexel, Nebraska, on September 17, 1918, obtained the following free air data. Altitudes are expressed in meters and temperatures in centigrade degrees. The ground has an elevation of 396 meters.

<i>Altitude</i>	<i>Temperature</i>
396	8.7
627	13.9
1,187	11.1
2,443	-0.3
3,094	-5.0
3,292	-7.0

- a. Plot the lapse rate.
 - b. What part of the air is stable?
 - c. What part is conditionally unstable?
6. Explain the formation of an icicle.

CHAPTER V

Condensation of Water in the Atmosphere

Since water is a large and essential constituent of living organisms, the earth is habitable only because of the large amount of moisture at its surface and in its atmosphere. The evaporation of water, forming a gas which mixes with the other gases of the air, and its condensation again at or above the earth's surface are processes of the greatest practical as well as theoretical importance in the study of the weather. It has already been shown that the cooling of water vapor causes part of it to condense. In the atmosphere, cooling is the only cause of any significant amount of condensation. It is important to remember this fact in considering the causes of cloudiness and precipitation.

In the long run, since the amount of moisture in the air is doubtless becoming neither greater nor smaller, evaporation into the air must be balanced by condensation from the air. Over the earth as a whole, rainfall, plus dew, frost, and fog deposits are equal to evaporation. This, of course, is not true, except by accident, for any one place on the earth or for any given period of time. Evaporation is a continuous process; precipitation is irregular and intermittent. The moisture evaporated is often carried great distances and held for long periods before being precipitated.

Condensation on Solid Surfaces

Condensation begins first on solid surfaces because these get colder than the general mass of air. The earth and all solid objects are better radiators of heat than is the air; at night they cool more rapidly than the air, this being espe-

cially true when the sky is clear and affords but little radiation itself. The air also loses some heat by radiation, but very slowly, and the air close to the surface is mainly cooled by the conduction of some of its heat to the colder surface.

Dew.—Air that comes in contact with cold surfaces may thus be cooled below its dew point, in which case some of its moisture is condensed and deposited as dew on the cold objects. If the air is quite calm, the lower three or four feet may be appreciably cooled by conduction during a single night. Usually, not even this thickness is cooled to its dew point, but only the air which actually comes into contact with the cold surfaces. It is hardly correct, then, to say that dew falls; rather, it condenses where it is deposited. If the air is quiet, the cooling of the lower air produces an inversion of temperature, which decreases turbulence and so contributes to further stability and calmness. The air at the ground is thus left long in contact with the cold surfaces and is given a good opportunity to reach its dew point. By this process the air within a few inches of the ground may become considerably colder than that immediately above it. On the other hand, movement and turbulence in the lower air cause a mixing to a height of several feet. The cooling extends to a greater elevation than in quiet air, but, since none of the air is cooled so much, it may be that none of it reaches its dew point. Hence, wind tends to prevent the formation of dew.

Frost.—When the dew point of the air is below 32°F., moisture condenses directly from the gaseous to the solid state in the form of ice crystals, called *frost* or *hoarfrost*. This is the sense in which the word frost is used in the United States. Note that it is not frozen dew. In England the word is used somewhat differently; there frost denotes freezing weather, and *degrees of frost* means the number of degrees that the temperature falls below freezing. *Rime* is a feathery deposit of ice from freezing fog and may occur either day or night. Frosts are classified by the United States Weather Bureau as light, heavy, or killing.

A *killing frost* is defined as a frost that is destructive of the staple crops of the locality. The expression *black frost* is sometimes used to indicate a freeze severe enough, whether attended by hoarfrost or not, to kill all or nearly all green vegetation so that it quickly wilts and turns dark. Light and heavy frosts are distinguished largely by the amount of the deposit and are without exact definition.

Frosts occur most readily in low places, especially if there is no outlet. The cold, heavy air drains along the sloping surfaces into such low places and accumulates there, becoming still and stable and considerably colder than the general mass of air. In many parts of the world, fruit is grown successfully on slopes and in foothill regions, but not on adjacent valley floors. Even on level ground, frosts may form when the general air temperature is well above freezing, especially if there is not sufficient wind to move and mix the air. On a cold winter day, frost often occurs on the inside of a window in a general air temperature of 70°F. within the room, for the same reason that frost occurs outside, that is, by the conduction of heat to a cold surface. An electric fan directed toward the window will clear it of frost by a better mixing of the air.

The conditions necessary for the formation of dew or frost in nature are: (1) clear sky (except that in cloudy winter weather a damp wind moving over cold ground may produce frost), (2) still air in stable equilibrium, and (3) sufficient moisture to reach the dew point with a moderate amount of cooling. The prediction of frost takes account of these factors and of one further consideration in respect to the dew point. If the dew point is above 32°F., condensation will begin as dew, and the latent heat thus set free will retard the further cooling. Freezing temperatures are thus less likely to occur when the dew point is above freezing than when it is below 32°F.

Protection against frost.—In western and southwestern fruit-growing regions, when injurious spring frosts or freezes occur, it is usually on “radiation nights,” that is,

under clear and quiet conditions. Many orchards in those regions are protected from injury under such conditions by placing one- or two-gallon pots of burning fuel oil among the trees. In the use of these heaters three factors are effective in preventing injury: (1) The lower air is warmed



Fig. 47. Orchard Heaters. Five-quart lard-pail heaters burning at day-break. The set first lighted has burned dry, and the second lighting is burning low. *Courtesy, U. S. Weather Bureau, Washington, D. C.*

by the heat produced; (2) the fires create small convection currents which mix the air to about the heights of the tree tops; (3) such smoke as is formed acts as a blanket to retard cooling by radiation. Larger fires would be less effective, by reason of carrying the heat above the trees, as well as being dangerous to the trees. It is evident that such protection is not feasible where freezing temperatures occur with cold winds and not as a result of radiation.

No considerable part of continental United States is entirely immune from frost, but in the southern half of Florida, certain limited areas in California and Arizona, and a small area in southern Texas, frosts are sufficiently rare to

permit the growth of citrus fruits and winter vegetables, but not without occasional losses. The Hawaiian Islands are entirely free of frost at elevations below 2,500 feet, and Puerto Rico is without frosts.

Condensation above the Earth's Surface

In broad terms, condensation of water vapor in the free air, as at the surface, is the result of cooling. The condensation takes many forms. The word *hydrometeor* is sometimes applied to any atmospheric phenomenon dependent upon the water vapor in the air, such as dew, fog, cloud, rain, and so forth. In a more limited usage, only particles of solid or liquid water falling through the air are called hydrometeors.

Nuclei of condensation.—If air is perfectly free from dust, it may be cooled far below its dew point without any condensation; the vapor is then supersaturated. Moreover, ordinary mineral dust, as from a land surface, may be added to such supersaturated air without starting condensation. But if smoke or salt spray from the ocean is added, rapid condensation occurs. In fact, with such substances in the air, moisture will begin to condense before what we ordinarily call saturation is reached. Some of the ocean salts and some of the products of combustion have the quality of absorbing moisture from the air and for this reason are said to be hygroscopic. Apparently the presence of hygroscopic, or at least water-soluble, particles is essential to the condensation of moisture in the air, and such particles are called nuclei of condensation. Fires, ocean spray, explosive volcanoes, and burning meteors furnish large numbers of dust nuclei. All tests that have been made show that nuclei are always present in the air in adequate numbers.

Fog, haze, and drizzle.—Fog may be defined as moisture condensed from and present in the air near the surface of the earth, in amount sufficient to reduce visibility. The moisture may be either water droplets or ice spicules. Recent measurements indicate that the size of the particles

ranges from 2/2,500 to 1/25,000 of an inch. The latter value is not much greater than the wave length of red light. A given fog has droplets of various sizes, but one size usually predominates. The prevailing size differs in different fogs. Fogs are sometimes briefly defined as clouds near the earth's surface, but they may be distinguished from clouds by their methods of formation, which will be discussed in the next two sections. Accumulations of dust or smoke in the air are sometimes called dust fogs or smoke fogs but should be distinguished from true fogs. Smoke furnishes numerous hygroscopic nuclei and probably facilitates the formation of fog. Certainly smoke darkens fog and reduces the visibility. For this reason, thick fogs are more frequent in smoky cities than in adjoining country districts, but smoke abatement, though very desirable in itself, would not put a stop to fogs.

The Weather Bureau now classifies fogs in four densities in terms of their effect on visibility, as follows:

Light fog—visibility $\frac{5}{8}$ mile or more.

Moderate fog—visibility between $\frac{5}{16}$ and $\frac{5}{8}$ mile.

Thick fog—visibility between $\frac{1}{8}$ and $\frac{5}{16}$ mile.

Dense fog—visibility less than $\frac{1}{8}$ mile.

Fogs merge gradually into *drizzle* as the droplets become larger. Drizzle implies light rain, which is falling, or at least can be felt on the face. On the other hand, when the fog droplets become smaller and less numerous, fogs grade into *moist haze*. In haze there is no visible obscuration of nearby objects, within about half a mile, but distant objects become blurred and the sky has a gray appearance. Nearly the same effect may be produced by *dry haze*, resulting from dust or smoke or from optical irregularities of the air.

Radiation fogs.—Two processes are distinguished in the formation of fog. One of these is the process of cooling by radiation, and the resulting fogs are named *radiation fogs*. Radiation fogs may be either *ground fogs* or *high fogs*.

Ground fogs are a result of the cooling of the earth's surface and the lower air at night, producing an inversion of temperature. They occur principally in the early morning hours. Sometimes only dew or frost follows such cooling, but at other times the entire mass of air to a height of a few feet or a few hundred feet is cooled below its dew point, and then there is fog. Cooling by conduction extends only about 4 feet into the air, as we have seen, and we must therefore have some mixing by eddy motion or turbulence to cool a considerable thickness of air to saturation.

A light wind of 4 or 5 miles per hour is sufficient to produce turbulence when moving over uneven ground or around trees and buildings, and such a wind is conducive to fog, but higher winds carry away the cooled air, destroy the inversion, and prevent fog. Fogs of this character do not extend to any considerable height, frequently not over 100 feet; hence, their name, ground fogs. Because clear weather permits rapid cooling, ground fogs are fair weather fogs; that is, the air is bright and clear above and also at the surface when the sun breaks through the "vapors that did seem to strangle him."

High fogs.—Sometimes an inversion of temperature occurs in the upper air, at elevations of 600 to 6,000 feet. This prevents upward movement by convection or turbulence and permits the accumulation of dust and smoke at the base of the inversion. These conditions facilitate the cooling of a layer of upper air by radiation and may lead to the formation of a high fog, which is hardly to be distinguished in appearance from a stratus cloud. When air from polar regions moves over the North Atlantic and becomes stagnant over Europe, such fogs frequently form and persist day and night for several days or even weeks. In this country, along the seacoasts, especially in southern California, there are frequent high fogs, which are called *velo* clouds. They are usually dissipated by the sun during the forenoon.

Advection fogs.—The second process by which fogs are often formed is the movement of warm moist air over cold

surfaces. These are called *advection* fogs, advection meaning the horizontal shifting of the fog itself, or of the air which causes it. The first essential in the formation of such a fog is the importation of warm, moist air. The second is the cooling of the air to saturation by conduction to the cold earth. Third, turbulent mixing extends this saturated layer to considerable heights. Such fogs may occur with moderately strong winds, and the higher the wind, the deeper the fog layer will be, if formed at all. Advection fogs usually extend to much greater heights than ground fogs and often occur with cloudy weather and falling pressure.

Over continental interiors advection fogs are more frequent in winter, when the ground is cold or snow-covered. On western seacoasts in temperate latitudes, warm, moist, sea air, drifting inland over radiation-cooled land, is often the occasion for such fogs. At sea they occur where there are adjacent bodies of water of contrasting temperatures. The dense and persistent fogs in the vicinity of Newfoundland are of this character and result from the movement of air from the warm water of the Gulf Stream to the cold water of the Labrador Current. Fogs of this type are also frequent from Greenland eastward to Iceland and Spitzbergen, owing to the meeting of relatively warm and cold ocean waters in this region.

Fog cost and dispersal.—Dense fogs are very expensive affairs. They are the cause of many accidents; they delay traffic by land and sea, and cause many shipwrecks; they increase cleaning bills and the use of gas and electricity, and are a special menace to aviation. London, "pea soup" fogs are perhaps the densest and blackest in the world, and there, when the fog is dense, people are unable to get from their offices to their homes, physicians cannot answer calls, the mail is not collected, the fire apparatus goes to a fire with a man walking in front carrying a lantern. Considerable thought has been given to the possibility of the dissipation of fog, particularly over small areas such as

airplane landing fields. Not much success has yet been attained, the greatest difficulty being that the cleared air is continuously replaced by foggy air.

Clouds and Precipitation

In contrast to fogs, which result from cooling by conduction or radiation, clouds are chiefly the result of the dynamic cooling produced by expansion under reduced pressure. Reduction of pressure aloft may sometimes produce enough reduction of temperature to effect the formation of clouds, but by far the most important cause of clouds is the dynamic cooling resulting from upward movement of the air. Some clouds are formed by the mixing of warmer and cooler air.

The exact processes involved in the production of copious rain are not fully known, but according to Simpson¹ there are three necessary conditions. These are: (a) large quantities of water must be released under the influence of ascending currents; (b) the cloud particles must be of different sizes, so that they will move at different speeds; (c) the cloud must have considerable depth, so that a falling drop may meet many smaller drops as it descends. After the descent begins, the drops grow mainly by combining with the cloud particles through which they fall. If any one of these conditions is absent, the clouds may persist but there will be no rainfall of importance. It has recently been shown that the simultaneous presence of snowflakes and water droplets in the central portion of a cloud facilitates the rapid formation of large rain drops.

Rain falls beneath the air in which it is formed, or it is carried short distances by the wind. Even if the space above us to the top of the air were saturated, it would not as a rule contain enough water to make more than an inch of rain. Such a condition of complete saturation never occurs, and, moreover, only a small part of the

¹Simpson, Sir Geo. C., "On the Formation of Cloud and Rain," *Quarterly Journal*, Royal Meteorological Society, April 1941, Vol. 67; 99-133.

moisture in the air is ever removed by natural processes of condensation. It is evident, therefore, that a large amount of water cannot fall from a given mass of air, but can come only from a continual renewal of the moisture supply. Hence, one necessary condition for a heavy rain is a continuous supply of moist, rising, inflowing air. Rain may be held aloft by rapidly rising air for a time, and then suddenly released when the updraft ceases; this results in an extremely heavy rain, of short duration, and over a small area. Such a shower may be called a *cloudburst*. The word should be confined to rain of this character but is sometimes erroneously applied to any heavy rain in mountain regions, where the run-off from a large area is collected into narrow valleys, giving the appearance of heavier rain than has actually fallen.

The magnitude of the operations involved in the production of rain is seldom appreciated. One inch of rain weighs 113 tons per acre or 72,300 tons per square mile. A general rain of one inch over the state of North Dakota means the precipitation of 5 billion tons of water. All this water has first been lifted high into the air. The tremendous energy of the natural forces involved and the futility of trying to control them or to produce important amounts of rainfall artificially are evident. Nature produces the necessary sustained upward movement in one of the ways mentioned in the next three sections.

Penetrative convection.—The uplift may be by means of local convection currents, when certain portions of the lower air become so much heated that they are able to penetrate the overlying air. In such cases, descending columns of air are to be expected between the rising columns, as indicated in Fig. 48. This penetrative convection is to be distinguished from the general expansion and upward movement of an entire, extensive layer of air. In cases of penetrative convection, clouds are apt to occur in relatively small masses, such as detached, flat-base cumuli. After condensation begins, the retarded cooling favors rising of the air

and increased thickness of the cloud layer, and thus cumulonimbus clouds and thundershowers frequently occur.

On quiet summer afternoons when such cumuli are forming, we may reasonably assume that the air is homogeneous

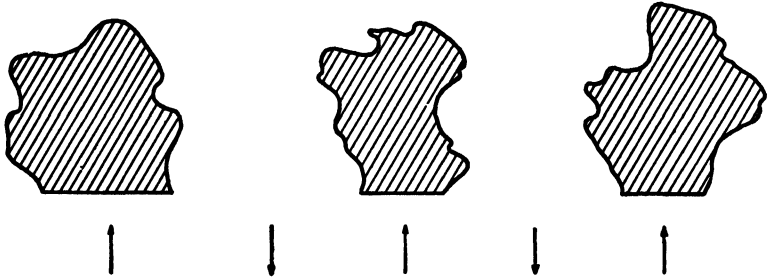

Fig. 48. Penetrative Convection Producing Summer Cumuli.

from the ground level to the cloud bases. With that assumption, the height of the clouds can be calculated roughly, given the temperature and dew point at the surface. It is to be noted not only that the temperature of the rising air falls at the adiabatic rate (5.5°F. per 1,000 feet), but also that its dew point falls at the rate of 1.1°F. per 1,000 feet. The rising vapor expands because of reduced pressure, and this increase in volume decreases the concentration of the vapor and, hence, lowers the dew point. Calling the height of the cloud bases, H ; the temperature at the surface, T_o ; and the dew point, D_o ; the temperature at the bases of the clouds, T_h ; and the dew point, D_h , we have

$$T_h = T_o - (5.5/1,000) H,$$

and we also have

$$D_h = D_o - (1.1/1,000) H.$$

But since H is the height at which condensation is begin-

ning, T_h and D_h represent the same temperature. Hence,

$$T_o - (5.5/1,000) H = D_o - (1.1/1,000) H,$$

from which $4.4 H = 1,000 (T_o - D_o)$, and since T_o and D_o may be obtained by observation, the height of the cloud bases is easily calculated.

Orographic uplift.—Air may be forced upward by the movement of winds over rising ground. When winds move across a mountain range, large masses of air are made to rise. Continuous sheets of cloud, such as cirrostratus and altostratus, often result, and continuous rain also. As the air moves downward on the other side of the mountains, it is dynamically warmed and becomes dry and clear. Where winds are prevailingly from one direction across a mountain system, the windward side is wet and the lee side dry. The Sierra Nevada and the Rocky Mountains are wet on their western slopes and dry on the eastern. The Hawaiian Islands, with an elevated central backbone, have a very wet side facing the persistent northeast trade winds, and an opposite very dry side.

Convergence and eddy motion.—When winds from different directions converge toward a center, as is the case in some of the storms to be studied later, some of the air is forced up, often resulting in clouds and precipitation. Also, when currents of air of differing temperatures meet at an angle, the heavier air will remain in the lower position, and the lighter air will be forced to rise. In both these cases the air is said to converge, and such convergence is the chief cause of cloudiness and precipitation, outside the tropics and mountain regions. Convergence is often attended by continuous cloud sheets and steady, prolonged rain. In other circumstances it causes detached cumulonimbus clouds and showers.

The upper layer of the atmosphere may have a turbulent wave motion because of a difference in density of air masses moving from different sources. The vapor at the tops of these waves may be cooled below its dew point, while the

lower portions of the waves remain unsaturated. Under these conditions, clouds form in long lines or rows, such as are frequently seen in cirrocumulus, altocumulus, and stratocumulus types. Rain from this wave-like movement is not to be expected. It is to be noted that clouds and precipitation result from convection, from forced upward movements over rising ground, and from convergence; and clouds, but no precipitation, from atmospheric waves.

Forms of Precipitation

As the drops of water or particles of ice of which clouds are composed increase in size, they begin to fall more rapidly and eventually reach the ground as precipitation, unless held up by ascending air currents or evaporated on the way down. Ascending currents furnish the three conditions mentioned on page 134 as necessary for the growth of rain drops. They produce continuous cooling and continuous condensation. They are irregular and gusty, resulting in clouds that are not homogeneous but are composed of particles of many different sizes. They reduce the rate of fall, thereby increasing the effective depth of the cloud and give the drops a greater opportunity to grow by coalescence. Ascending layers of air, caused orographically or by convergence and underrunning, are less turbulent and more nearly homogeneous than penetrative convectional currents, and the resulting rain drops are usually smaller. Precipitation takes various forms, depending upon the temperature at which condensation takes place and the conditions encountered as the particles pass through the air.

Rain.—The words rain and rainfall are often used to include all forms of precipitation, but in this paragraph rain refers specifically to moisture which has condensed at temperatures above the freezing point of water and which falls to the earth in its liquid state. Raindrops vary in diameter from 0.004 inch, in mist, to 0.2 inch in thunderstorm rain. There is a natural limit to the size of raindrops. Large drops falling through quiet air break up into smaller

ones when they attain a velocity of 18 miles per hour. Conversely, no rain can fall through an ascending current of this velocity.

Snow.—Condensation occurring in the air after its temperature has fallen below 32°F ., takes the form of snow.

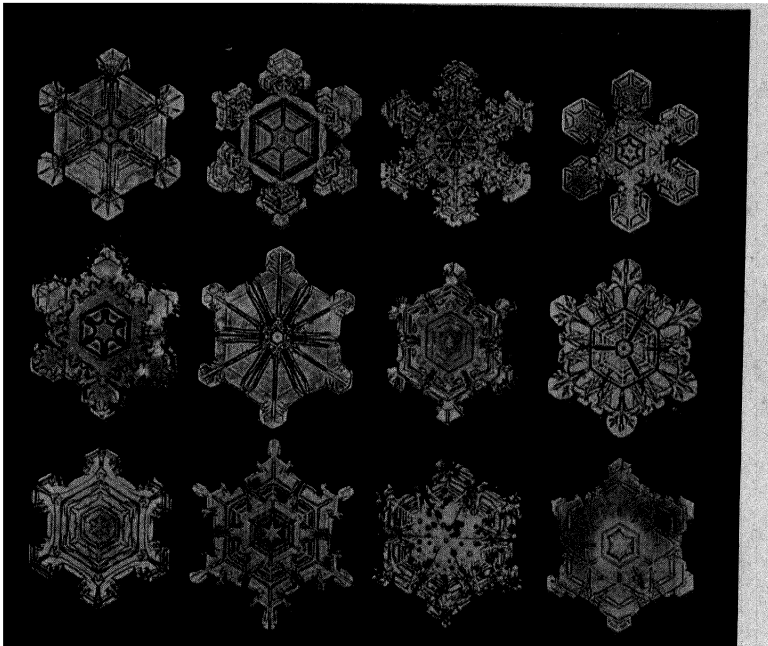

Fig. 49. Snow Crystals. *Photomicrographs by W. A. Bentley, Courtesy, U. S. Weather Bureau, Washington, D. C.*

Snowflakes are crystals of many beautiful, lacy patterns. The fundamental form is hexagonal, but this is subject to much intricate elaboration, apparently influenced by the temperature, and perhaps also by the rapidity of condensation. At very low temperatures there can be but little moisture in the air, and therefore under such conditions, precipitation is apt to be light, but it is never, "too cold to snow." Snow has been recorded in Alaska at a temperature of -52°F . As previously noted, a snow cover, being

a poor conductor, keeps the soil temperature higher than it would otherwise be under winter conditions, but it keeps the air temperature lower, because it is not much warmed by sunshine and cools rapidly by night. Snow that accumulates in mountain regions during the winter and gradually melts in spring and summer is of great economic value in affording water supplies and maintaining the flow of rivers. On the other hand, the removal of snow from streets, roads, and railroads involves a large annual expense, in regions where the snowfall is heavy.

Hail.—Hail consists of hard, rounded pellets of ice, or of ice and compact snow. When a hailstone is cut in half, it is seen to be composed of concentric layers of differing densities and opacities. Hailstones as large as marbles are common, and sometimes stones of much greater size occur. At Potter, Nebraska, on July 6, 1928, a few very large stones fell, one of which was 5 inches in diameter and weighed $1\frac{1}{2}$ pounds.² Large flattened disks of ice are

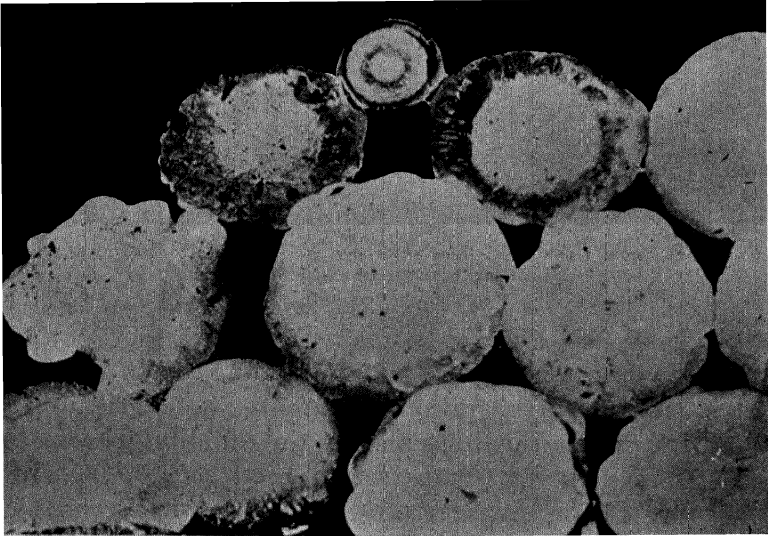

Fig. 50. Typical Large Hailstones Showing Layer Structure. *Courtesy, U. S. Weather Bureau, Washington, D. C.*

² Blair, T. A., "Hailstones of Great Size at Potter, Nebraska," *Monthly Weather Review*, Aug. 1928, Vol. 56, p. 313.

sometimes found; these are composed of several stones, formed independently, and frozen together while falling. The destructive effects of heavy hail, especially in the beating down of growing crops and the breaking of glass, are very great. The area of destruction in any one storm is usually small, although occasionally quite extensive. Hailstorms are frequent in the central valleys of the United States, during spring and summer, and losses in that region aggregate many million dollars per year. Accurate statistics are available showing that the average annual loss in Iowa between the years 1923 and 1930, inclusive, was \$4,500,000.00, which was 1.15 per cent of the total value of the crops at risk.

Formation of hail.—Hail falls only in connection with a thunderstorm, and from cumulonimbus clouds. In such clouds there is an active convectional updraft of warm, moist air. In this rising air, condensation frequently begins as rain, but the drops, instead of falling, are carried upward by the rapidly ascending currents. Thus they are lifted into cloud regions where the temperature is below freezing and where snow is forming. Here they congeal and then acquire a coating of snow and frost, thus becoming hailstones. Eventually, they enter a weaker updraft and descend to lower portions of the cloud. Here they gather a coating of water, a part of which freezes around the cold center, and may then encounter another strong updraft and be carried upward again into the snow region. In these journeys they probably grow most rapidly by the freezing upon them of the undercooled water drops with which they collide. By these processes a hailstone sometimes acquires several alternate layers of ice and snow and reaches a large size before falling to the ground. The ultimate size of a hailstone appears to depend mainly upon the upward velocity of the air, the concentration of undercooled water in the air through which it moves, and the length of its path through such air.

Snow pellets, sleet, and glaze.—Soft, moist snowflakes,

falling through gusty air, are sometimes blown together to form small snowballs and reach the ground as white pellets. These are called *snow pellets* (also known by the German name *graupel*, or the English equivalent, *soft hail*). *Sleet*, as the term is now officially used in America, means precipitation in the form of small particles of clear ice which are originally formed as raindrops, and are later frozen as they fall through a layer of cold air. In Great Britain, and sometimes popularly in this country, the word designates a mixture of rain and snow or partly melted snow.

Precipitation sometimes occurs in the form of rain when the temperature of objects at the earth's surface is considerably below freezing. This results in the formation of

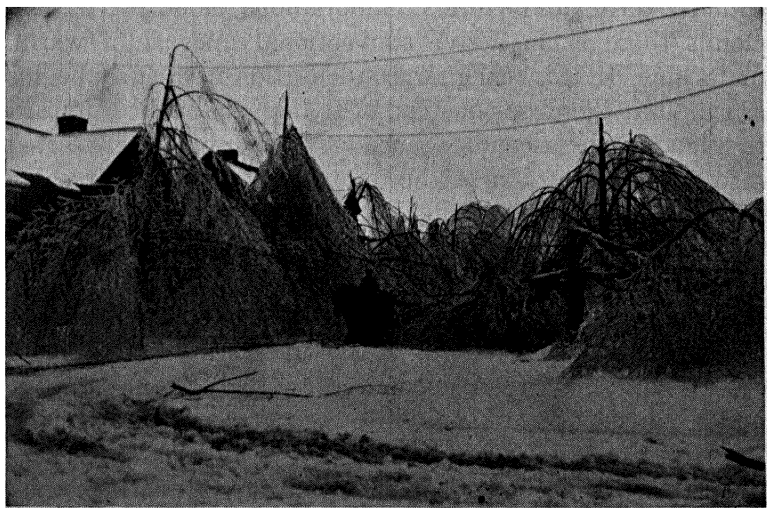

Fig. 51. Glaze. "Ice storm" of November 26-29, 1921, at Worcester, Mass. Courtesy, U. S. Weather Bureau, Washington, D. C.

a coating of ice on trees, wires, paving, and other objects. Such a deposit is called *glaze* in this country, and *glazed frost* in Great Britain. Its occurrence is often popularly called an *ice storm*. The damage to trees and wires, resulting from breakage by overweighting, is often large, espe-

cially when the storm is followed by high winds. Deposits more than 2 inches in diameter have often been observed. The slippery condition produced on paved walks and roads creates a serious hazard to pedestrians and motorists.

Summary

All air contains water vapor. The pressure of this vapor equals the saturation vapor pressure at some lower temperature. Condensation therefore results from cooling the air. The surface of the earth and the leaves of plants cool at night by radiating their heat. As air moves slowly against these cold surfaces, its water vapor comes in contact with them and is cooled to saturation, resulting in the formation of dew or frost, although the temperature of the body of air remains above its dew point. Frosts often occur when the air a few feet above the surface is considerably warmer than 32°F. This is especially likely to occur in low places, where cold air accumulates. Dew and frost are deposited when the air is clear, quiet, and moist. After condensation begins, the released heat retards the cooling.

Fog results from the cooling of an entire layer of the lower air below its dew point. The cooling may be radiation cooling at the surface (ground fog), radiation cooling at an inversion layer aloft (high fog), or cooling by the conduction of heat from a layer of warm, moist air moving over a cold surface (advection fog). Fogs occur without any material change in the elevation of the air. Clouds and precipitation, on the other hand, result from the dynamic cooling of rising air. The ascent of the air may be due to thermal convection, to forced ascent over rising ground, or to forced ascent by the convergence of winds from different directions. Condensation in the air, whether as fog or cloud, begins around water-soluble particles, mostly of minute size. These are furnished by smoke, ocean spray, volcanic explosions, and burning meteors.

Precipitation takes the form of rain, when temperatures remain above freezing; snow, when condensation occurs be-

144 CONDENSATION OF WATER IN THE ATMOSPHERE

low freezing, and the descending flakes remain frozen; hail, when the particles are subjected to alternate freezing and thawing; snow pellets, when soft snow is compacted into white balls; and sleet, when raindrops are frozen into icy pellets. Glaze is the coating of ice formed by the freezing of rain as it falls on objects.

Problems

1. On a calm, clear, spring evening when frost threatens, if the temperature, beginning at 5 P.M., falls at the rate of 2° per hour until condensation begins, and thereafter 1° per hour until 5 A.M., (a) When will condensation begin? (b) Will it be dew or frost? (c) What will be the minimum temperature? Assuming the basic conditions as stated, work out the answers to the questions from the following data:

(1) The 5 P.M. temperature is 52° , and the relative humidity is 63 per cent.

(2) The 5 P.M. temperature is 52° , and the relative humidity is 40 per cent.

(3) The 5 P.M. temperature is 48° , and the relative humidity is 75 per cent.

2. At a noon observation on a quiet summer day, the temperature of the air is 90° , the wet-bulb thermometer reads 67° , and detached cumulus clouds are observed;

a. How high are the bases of the clouds?

b. What is the temperature at the bases?

c. If the clouds are 1,200 feet thick, what is the temperature at the top?

3. If air on a plain 3,000 feet above sea level, having a temperature of 42° and a dew point of 36° , is forced over a mountain at an elevation of 12,000 feet above sea level, and then descends on the other side,

a. At what height will condensation begin?

b. What will be the temperature at the mountain top?

c. What will be the temperature when it has descended on the other side to its original altitude of 3,000 feet?

CHAPTER VI

Interrelations of Temperature, Pressure, and Wind

In the discussion of convection we have noted some of the relations between the pressure, temperature, and movement of the air, with particular attention to vertical movements. Additional relations between these elements of the weather are now to be noted, especially with reference to horizontal, or approximately horizontal, movements of the air.

Pressure Gradients

Large numbers of pressure records have accumulated during the past hundred years, from all parts of the world, and they show that the pressure of the air is variable in a number of different ways. First, there is continuous variability of pressure at the same place from hour to hour. Second, pressures differ in adjacent places at the same time. Third, average pressures in different parts of the world are not the same. And finally, average pressures at a given place change with the change of season; they are not the same in winter as in summer. Pressure variability results from vertical and horizontal movements of the air, brought about by differences in density, and these, in turn, are due chiefly to temperature differences.

Isobars and pressure gradients.—To represent the various pressures over an area, lines known as isobars are drawn on a map through points of equal pressure. They may represent the distribution of pressure at a definite time, or the average distribution for a given period. The curved

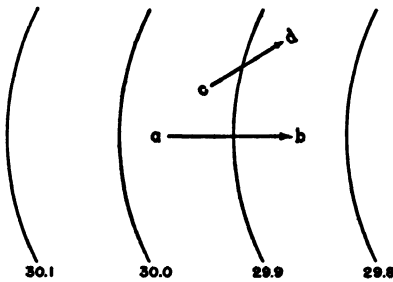

Fig. 52. Isobars and Pressure Gradients.

lines in Fig. 52 represent isobars on a map, showing a pressure decreasing from 30.1 inches at the left to 29.8 inches at the right. Air pressure, as measured by the barometer and as represented by these lines, is a force proportional to the weight of the air above the point of measurement.

Simultaneous differences of pressure over an area, therefore, cause movements of air tending to equalize the pressure. A force pushes the air from the region of higher barometric pressure toward the region of lower pressure.

The difference between the pressure at the points *a* and *b* is the force that is pushing the air at *a* toward *b*. In every case, the magnitude of the force depends on the difference of pressure, that is, on the rate of change of pressure with distance. The rate of change of pressure per unit horizontal distance is called the *pressure gradient*. It usually means the change in a direction perpendicular to the isobars, since that is the direction in which the change is most rapid, but note that there is a gradient in other directions, also, such as *cd*. The gradient is expressed in hundredths of an inch per 500 miles of distance, or as millimeters or millibars per degree of latitude. Since the force increases as the gradient gets larger, the rate of movement of the air also increases. Both the direction and the velocity of the wind are, therefore, directly the result of the pressure gradient, but the actual movement of the air is modified by the earth's rotation, by centrifugal force, and by friction.

Isobaric surfaces.—The vertical distribution of pressure in the air above a given area may be represented by lines drawn to indicate the heights at which pressures are equal. Such lines then represent isobaric surfaces in the atmos-

phere. Since the ground-level pressures are not equal over the area, the isobaric surfaces above the earth are not, in general, parallel with the ground but are warped in various ways. If the points *A*, *B*, *C*, and *D* in Fig. 53 have pressures ranging from 30.2 inches at *A* to 29.9 inches at *D*, then the isobaric surfaces above *ED* may be as represented in the figure. The intersections of these surfaces with the ground are isobars. Consider the horizontal line *FG* at some distance above the earth, and note that the pressure is greater at *F* than at such points as *M* and *N*, although

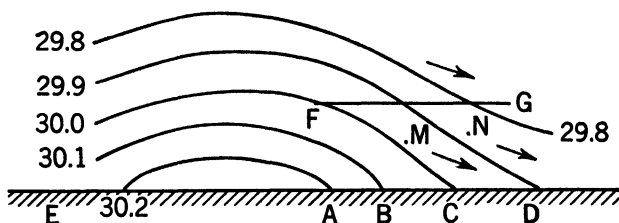

Fig. 53. Curved Isobaric Surfaces and Resulting Air Movements.

the latter are nearer the ground. There is, therefore, a pressure gradient outward from *F*, and the air flows out from the region of higher pressure as indicated by the arrows.

Gradient Winds and Surface Winds

A horizontal pressure gradient, if it acted alone, would lead to the flow of air along the direction of the gradient. Motion in the atmosphere under a pressure gradient, however, is profoundly modified by an effect due to the rotation of the earth, and the result is a flow perpendicular to the gradient instead of along the gradient, except for a greater or less deviation produced by friction in the lower levels.

Effect of the earth's rotation.—It may be shown by somewhat technical principles of theoretical mechanics that an object moving in any direction over the surface of the earth tends continually to turn toward the right in the Northern Hemisphere and toward the left in the Southern

Hemisphere. Its actual motion will be the resultant of this tendency and of whatever forces may act on it. The deflection is a kinematic effect; that is, it is an effect of the two motions involved, namely, the rotational motion of the earth and the movement of the body relative to the surface of the earth. The effect is the same as if the earth were at rest and a force were acting on the moving body. This influence is known as the *deflecting force* of the earth's rotation, or the *Coriolis force*. It is zero at the equator and increases regularly with distance from the equator. It acts at right angles to the horizontal direction of the wind, and is directly proportional to the horizontal velocity of the wind. It does not, however, have any effect on the speed of the wind.

The same effect is present in all motions relative to the surface of the earth, but it is inappreciable in most phenomena encountered in everyday experience because they are on a comparatively small scale. It does have to be allowed for, however, in calculating the motions of projectiles fired from long-range guns. It is of predominant importance in considering the larger movements of the atmosphere, as will appear in the two following chapters. Hence, the fact that *moving air always tends to deviate to the right in the Northern Hemisphere and to the left in the Southern Hemisphere* should be definitely fixed in mind. It should also be remembered that the speed of the wind is not affected by the deflecting influence.

The three forces affecting moving air.—Under a constant difference of pressure, the pressure gradient tends to move air in a straight line, but as soon as motion begins, the effect of the earth's rotation is to cause it to move in a curved path. When the curving motion begins, a centrifugal force is developed, tending to pull the air outward from its center of curvature. Hence, the movement of the air is the resultant of three influences acting simultaneously, namely, the pressure gradient, the earth's deflection, and the centrifugal force due to the curvature of the path with ref-

erence to the earth. These forces are illustrated in Fig. 54. The force, p , representing the pressure gradient, keeps a constant direction. The centrifugal and deflective forces, c , and d , are always perpendicular to the instantaneous direction of the wind. The force, c , is opposite to d when the movement is from a center of high pressure outward, as in

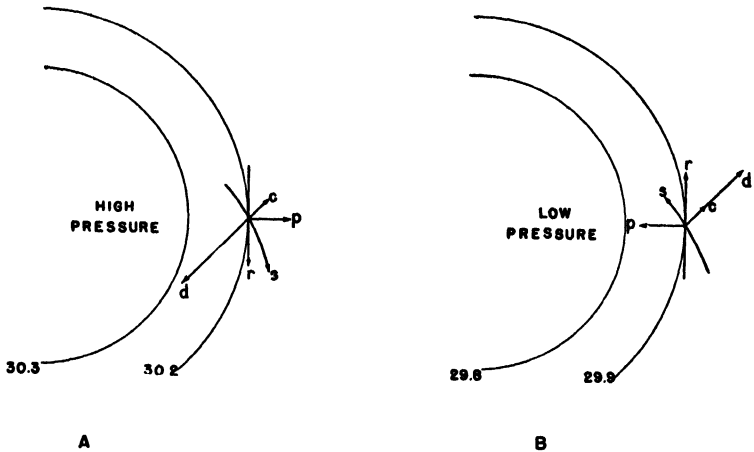

Fig. 54. The Three Forces Affecting Moving Air and the Resultant Gradient and Surface Winds in the Northern Hemisphere. c , centrifugal force; d , deflective force; p , pressure gradient; r , gradient wind; s , surface wind.

A , and in the same direction as d when the movement is inward to a center of low pressure as in B .

Gradient winds.—It can be shown, mathematically, that the resultant direction of motion, under these three forces, is along the isobars instead of across them, and the resultant velocity, when a steady state is reached, is such that the centrifugal and deflective forces together balance the horizontal pressure gradient. A wind moving along the isobars at a velocity such that the force due to pressure gradient is balanced by deflective and centrifugal effects, is called a *gradient wind*. Its instantaneous direction at the point of meeting of the forces is represented by the line, r , tangent to the isobar. The gradient wind results directly from the

pressure gradient, since the other forces are brought into action only after the gradient has initiated the movement. When the pressure gradient is known, the gradient wind can be calculated. Near the surface of the earth, friction and surface irregularities interfere with the free movement of the air, but at elevations of 1,500 feet and higher, the actual winds approach very closely, both in direction and in velocity, to the calculated gradient winds when the isobars are curved and regular. If the isobars are straight and parallel and the gradient does not change, the centrifugal force is negligible and the gradient force is balanced by the Coriolis force alone. The wind is then called a *geostrophic wind*.

Surface winds.—Turbulence near the earth's surface reduces the velocity produced by a given gradient. With reduced velocity the deflective and centrifugal forces are less, while the gradient force remains the same. The result is that the surface air moves across the isobars in the direction of the gradient, as indicated by the curved arrows, *s*, while the upper wind is moving in the direction *r*.

As a result of all these influences, we have the following general rule for the movement of the lower air: In a region of low pressure the air has an inward-curving motion in a counterclockwise direction in the Northern Hemisphere, and clockwise in the Southern. From a region of high pressure the air moves spirally outward in a clockwise direction in the Northern Hemisphere, and in the opposite direction in the Southern Hemisphere. In 1857, Buys-Ballot gave the following practical rule for determining the distribution of pressure from the wind direction: If you stand with your back to the wind, pressure is lower on your left than on your right in the Northern Hemisphere, and the reverse in the Southern Hemisphere. Note that this is true along either curve, *s*, in Fig. 54. This is known as *Buys-Ballot's Law*.

Winds Due to Local Temperature Differences

The following well-known winds develop under special circumstances and on a small scale as compared with the large movements of the air. They serve well to illustrate the direct relations between temperature, pressure, and air movement. Some of them are due to unequal heating of the air; in others the initial impulse is given by the loss of heat, that is, by cooling.

Sea breeze.—Along the seacoasts the land warms more than the adjacent water by day in summer sunshine. The warmed air over the land expands, bending the isobaric surfaces upward, and air flows out over the ocean from the upper surface of the expanded air (Fig. 55). This decreases the pressure over the land surface and increases it over the water, thereby starting, near the surface, a movement of air from the ocean to the land. This is the *sea breeze*, a partial convectional circulation. The circulation is incomplete because the air that flows out over the ocean from the top of the expanded layer spreads out broadly, and the downward movement is slow and distributed over a large area, so that little of the original air returns to the

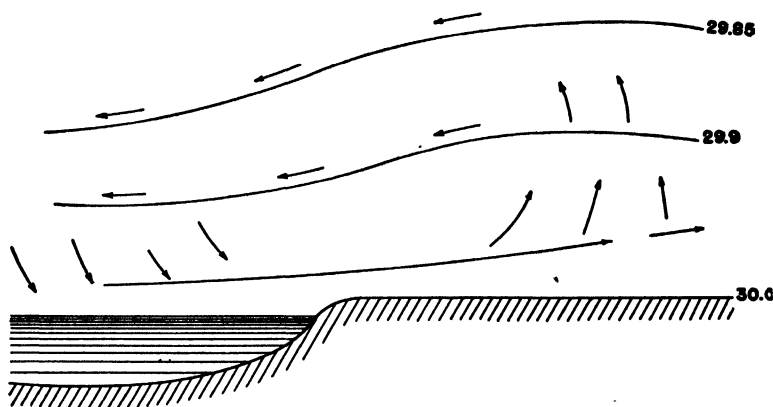

Fig. 55. Sea Breeze. The first result of heating the land is the upward bending of the isobars over the land; the second is the seaward flow of upper air; the third is the beginning of the breeze at sea.

land, but the lower air along the surface of the ocean flows inland. Only a shallow layer of the air is affected by these changes; the sea breeze is usually not more than 1,500 feet deep. It begins, usually about 10 A.M., some distance off shore and gradually extends inland to a distance of from 10 to 30 miles. Toward evening it begins to subside. At places around the Great Lakes, notably on the western shore of Lake Michigan, there is, in summer, a similar lake breeze, which, however, extends inland only 2 or 3 miles.

Sea breezes have an important moderating effect on the temperature of coastal regions. Where the sea breeze is of daily occurrence, as in parts of California, the afternoon temperatures average materially lower than they otherwise would, and the least agreeable part of the day is often in the forenoon before the breeze arrives. The cities of Chicago and Milwaukee have two summer climates, one within a mile or two of the lake shore, and a considerably warmer one a few miles back from the lake where the lake breeze does not reach.

Land breeze.—At night the land cools more than the water, the air over the land becomes denser than that over the water, and the isobaric surfaces slope downward toward the land (Fig. 56). When this occurs, air from the ocean begins to flow inland at the top of the cooled mass. This increases the pressure over the land and starts a movement out to sea at the surface. This is the *land breeze*, a wind due to local cooling. Again the circulation is incomplete; the vertical movements are so diffuse and gentle as not to constitute perceptible currents. The land breeze is usually less developed than the sea breeze; it is shallower, has less velocity, and extends only 5 or 6 miles over the sea. The principal reason for this is that temperature differences between land and water surfaces are less by night than by day. The effect of the land breeze is to remove the cooled air and to prevent the temperatures falling so low as they would if the air remained in place.

Valley breeze.—The heating of a valley floor and its slopes by day sometimes results in a slow movement of

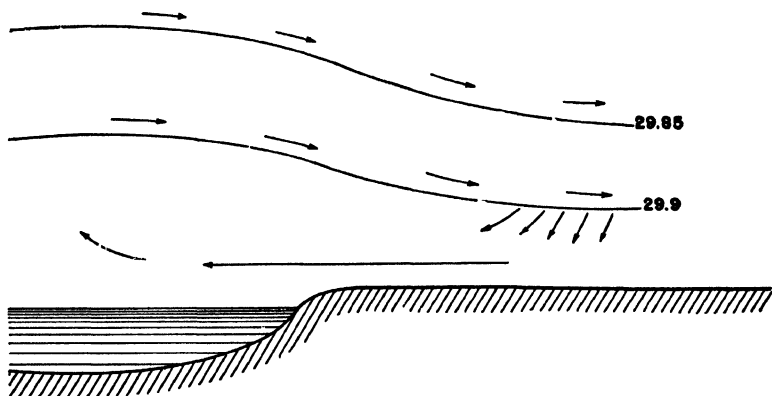

Fig. 56. Land Breeze. The first result of cooling is the settling of the isobaric surfaces over the land; the second is the landward flow of upper air; the third is the beginning of the surface breeze from the land.

warmed air up the valley or up the sides of mountains. The isobaric surfaces bend upward over the valley, and the air flows toward the sides. With specially favorable topography to concentrate the movement, a strong up-valley breeze may develop by day. In some coastal valleys, sea and valley breezes combine to produce strong winds.

Mountain breeze.—Air on mountain sides and sloping plateaus cools by night more rapidly than the free air at some distance from the slopes or even than the air in the valleys below. The draining of cooler, denser air down the slopes into the valleys, under the action of gravity, is somewhat analogous to the flowing of water down hill, but the air spreads out from the mountain sides, as water does not, and mixes with other air. The downward movement results in dynamic warming which by lessening the density of the air retards its flow. Hence, the movement is usually slow, and the warming effect of descent is more than offset by radiation cooling. The cold air may collect in pockets in the valleys and produce inversions of temperature, so that in the end (by morning) the valley bottoms are colder than the hillsides, from which the cold air has been displaced.

The air may converge in narrow canyons, and then gain considerable velocity and extend outward a few miles from the mouth of the valley. In these cases, when the descent is rapid because of convergence into narrow channels, radiation cooling, which proceeds slowly, may be largely counteracted by adiabatic warming. In Utah the effects of this warming and of the turbulent mixing of the air by reason of fairly rapid motion are sufficient to prevent early frosts in autumn and thus to prolong the growing season on the bench lands at the mouths of canyons.¹

Katabatic winds.—Along the northern coast of the Adriatic Sea, a plateau region rises at the rear of a narrow coastal plain. In the winter the air over this plateau sometimes becomes quiet and very cold by radiation cooling. It then flows down the slopes as a cold, northeast wind, known as the *bora*. The *bora* occurs either by day or night but is most frequent and strongest in the latter part of the night. A similar cold wind, coming from the higher and often snow-covered land to the north, occurs during the winter on the Mediterranean coast of France, where it is called the *mistral*. Such winds as the mountain or canyon breezes, and the *bora* and *mistral*, are given the general name of *katabatic winds*, *gravity winds*, or *fallwinds*, because they are due to the flowing of cold, dense air down slope under the pull of gravity. Fallwinds are common along the Norwegian coast, and violent katabatic winds often descend from the glacier-covered interiors of Greenland and Antarctica.

Sea breezes and valley breezes result from daytime heating, land and mountain breezes from nighttime cooling, katabatic winds in general from radiation cooling whether diurnal or of longer period. Hence all are typically clear-weather phenomena, and all are rather shallow.

¹ Hales, W. B., "Canyon Winds of the Wasatch Mountains." *Bulletin American Meteorological Society*, Vol. 14, Aug.-Sept. 1933; pp. 194-196.

Monsoons

Just as along the coast lines the relation between land and water temperatures changes daily under the influence of insolation by day and earth radiation at night, so in the longer period of a year there are seasonal temperature differences between entire continents and oceans. Continents are warmer than oceans in summer and colder in winter. The resulting tendency is to develop over continents relatively low pressure in summer and high pressure in winter.

Seasonal temperature differences set up convectional circulations analogous to sea and land breezes, but having an annual, instead of a diurnal, period. The wind tends to blow toward warm continental interiors in summer and from cold land areas in winter. These winds are called *monsoons*. *Monsoons* are winds which reverse their direction with the seasons, under the influence of seasonal temperature differences between continents and oceans. They are best developed in India, where larger phases of the movement of the air are also involved, as will be noted later. They are prominent in China and equatorial Africa and occur to some extent in Australia, the Spanish peninsula, and other places. In a large portion of the interior and eastern United States, the prevailing winds change from southerly in summer to northerly in winter. This reversal of the winds is a monsoon effect, and it is an important factor in the climate of the central and eastern states. It results in the presence of much warm and humid air from the tropical Atlantic and from the Gulf of Mexico in summer, and of much cold dry air from the interior of Canada in winter.

Polar-Equatorial Air Movements

Because of the great and permanent temperature contrast between tropical and polar regions, we might expect to find a convectional circulation, analogous to a sea breeze

or a monsoon, between equator and poles. On a uniform, non-rotating globe there probably would be a continuous circulation of this kind. On the actual earth there is, indeed, an interchange of equatorial and polar air but not a simple continuous exchange in a closed path. The existing temperature differences on the earth do compel movements of air between high and low latitudes, but a number of factors serve to make these movements complex and intermittent.

Modifying influences.—The deflection due to the earth's rotation prevents a simple north-south interchange of air. Winds which start as south winds in equatorial regions become west winds in northern latitudes, and north winds from Arctic regions become east winds. The lack of uniformity in the change of temperature from equator to poles is another factor which prevents a simple interzonal transfer of air. Diversities of the earth's surface, such as the irregular distribution of land and water, the variations in elevation of the land, and differences in kinds of surface covering, all result in local or widespread temperature differences which prevent the development of a continuous temperature gradient between equator and poles. These temperature divergences create local pressure gradients not related to latitude, as is illustrated by the monsoons, sea and land breezes, and other local winds. In the third place, these temperature relations change markedly with the seasons, as the sun travels north and south, thus interfering with a continuous circulation. Finally, there are irregular, moving disturbances of the atmosphere, to be discussed later, which render the actual zonal interchange of air still more complex.

All the winds discussed in this chapter are examples of the propensity of surface air to blow toward a warm area or away from a cold area. They also serve to exemplify Humphreys' concisely stated general principle: "Atmospheric circulation is a gravitational phenomenon, induced and maintained by temperature differences."

Summary

Observations show that the pressure of the air is continually changing and that average pressures differ both seasonally and geographically. These differences may be represented on a map by isobars, as differences in elevation are represented by contour lines on a topographic map. As the slope or grade of a land surface means its rate of change in elevation per unit horizontal distance, so pressure gradient means the horizontal rate of change in pressure.

As a result of pressure differences, air begins to move directly across the isobars from the higher to the lower pressure, with a velocity proportional to the pressure gradient. As soon as the motion begins, other forces are brought into action. The effect of the earth's rotation is to give an eastward movement to air that is moving toward either pole and a westward movement to air that is moving toward the equator; also, to carry eastward-moving air toward the equator and westward-moving air toward the poles. Hence, the tendency of the rapid rotation of the earth is to turn any moving air to the right in the Northern Hemisphere and to the left in the Southern Hemisphere, without affecting its velocity. In the Northern Hemisphere the motion is clockwise under a diverging force, that is, when the gradient is outward from a region of high pressure, and counterclockwise under the influence of a converging force, with gradient toward a center of low pressure. In the Southern Hemisphere, the directions of motion are reversed.

The deflective influence of the earth's rotation, therefore, causes the air to follow a path curved with reference to the earth, and this brings into play a centrifugal force resulting from the curvature and acting outward from the center of curvature. The combined result of the pressure gradient and the deflective and centrifugal forces is the gradient wind. Its direction is along, instead of across, the isobars,

and its velocity adjusts itself to a balance between the gradient force and the other forces. Near the surface of the earth, friction destroys this balance by reducing the velocity and therefore the deflective and centrifugal forces. This gives the advantage to the gradient force and causes the air to cross the isobars at an angle of 20° to 40° in the direction determined by the gradient. Hence, surface winds are not gradient winds; the latter occur only in the free air above surface influences.

Unequal heating or cooling of the lower air causes a warping of the isobaric surfaces in the air above the earth, thereby creating pressure gradients and initiating compensating convectional movements. These are illustrated on a comparatively small scale by the daily changes in wind direction along seacoasts and in mountain valleys. More extensive movements, having an annual period and known as monsoons, are set up between continents and oceans by the change in the relative temperatures of land and water areas as the seasons change. Monsoons blow inland during the summer and oceanward in the winter. The permanent temperature contrast between equatorial and polar regions is not attended by a similar direct convectional interchange of air. This is prevented by various modifying influences, such as the earth's deflective force, the local circulations just described, and other temperature diversities independent of latitude. But, intermittently and by more devious paths, much air does manage to move between high and low latitudes.

Problems

1. Given the following sea level pressure readings in inches: Omaha, 30.32; Des Moines, 30.20; Davenport, 29.98; Chicago, 29.65: and the following distances between cities: Omaha to Des Moines, 120 miles; Des Moines to Davenport, 140 miles; Davenport to Chicago, 130 miles:

a. What is the pressure gradient between each city and the one next east?

b. If the wind velocity between Omaha and Des Moines

is 15 miles per hour, what is the velocity between the other cities, assuming the velocity is directly proportional to the gradient?

2. Draw diagrams illustrating the pressure changes and air movements occurring in mountain and valley breezes.

3. Small cumulus clouds often occur with a sea breeze but not with a land breeze. Why?

CHAPTER VII

The General Circulation

Pressure and winds are different phases of the same large problem having to do with the distribution of the air over the earth, its changes in distribution, and the processes by which the transportation of great masses of air is achieved. This constitutes the central problem of meteorology, concerning which many details remain unknown, because of the great extent of the atmosphere and the variety and complexity of the influences affecting its movements.

Observations show that there are large areas of the earth where the winds are predominantly from one direction throughout the year, other areas where the prevailing direction changes with the seasons, and still others where the winds are so variable from day to day that no systematic movement is evident to the ordinary observer. Related to the variability of the wind direction is the fact, previously noted, that pressures are also changeable. Hence, it might be inferred that no simple, permanent plan of distribution of pressure and wind exists. Nevertheless, if we take the average annual pressure and the prevailing winds, over the globe, we find not only that pressure and winds are closely related, but also that their distribution may be generalized into a simple system, dividing the earth into a few large zones or belts. The average general distribution of wind movement is known as the *general circulation*.

Yearly Averages of Pressure

The mean annual pressures over the globe are represented in Fig. 57. For polar regions, both in the Arctic

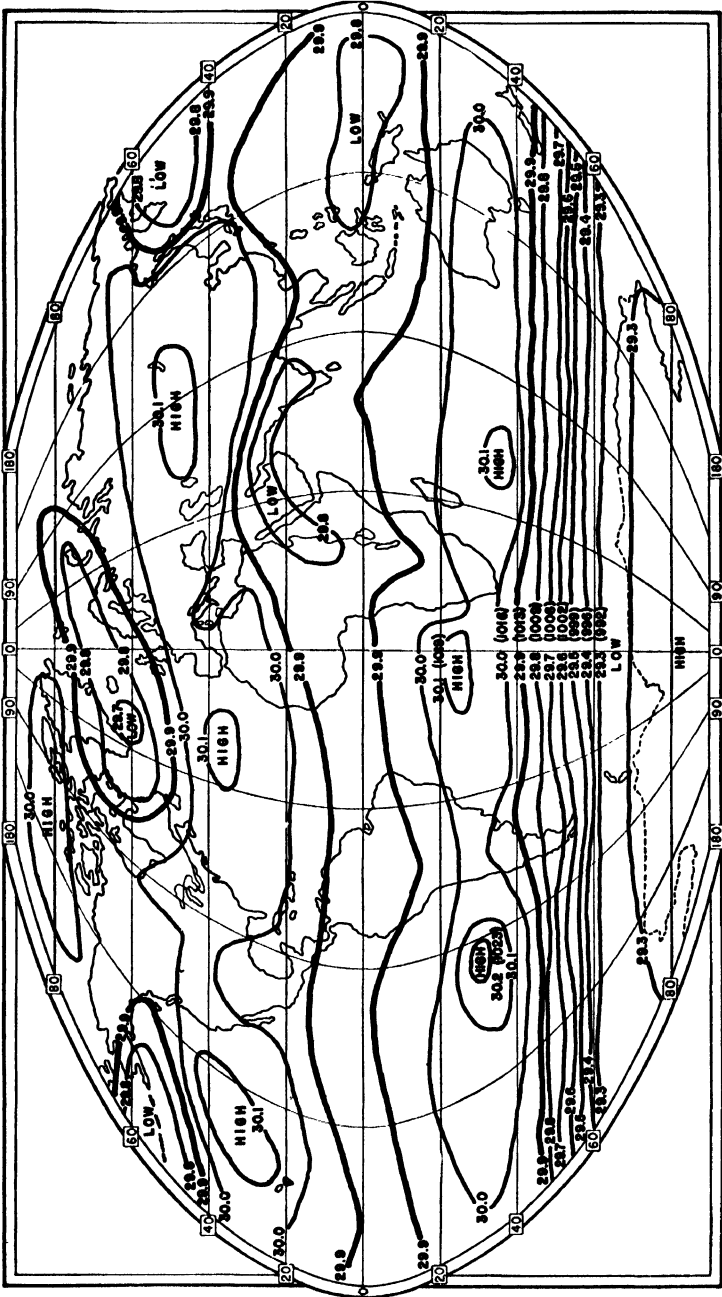

Fig. 57. Mean Annual Pressure in Inches and Millibars, World. Base map by permission Denoyer-Geppert Co.

and the Antarctic, data are meager and the isobars are doubtful. Especially over the Antarctic continent, pressure is uncertain, but it seems probable that it is considerably higher at the center of the continent than along the edges where the southern isobar of 29.3 inches (992 mb.) is indicated. A study of the chart will disclose the following alternating zones of high and low pressure.

Equatorial belt of low pressure.—In equatorial regions there is a belt where the pressure is less than 29.9 inches (1,013 mb.) throughout, and less than 29.8 inches (1,009 mb.) in parts of the Eastern Hemisphere. It varies in width, and in a large part of its area its center is somewhat north of the equator. Within the equatorial belt the winds are on the whole light and variable, with frequent calms but with an average, slow drift from east to west. The entire belt is frequently called the *doldrums*, but this word applied originally only to the ocean areas near the equator, where sailing ships were frequently becalmed.

Subtropical high-pressure belts.—Centered at about 35° north and 30° south latitude, there are irregular belts where the average pressure is above 30 inches (1,016 mb.) and within which are certain areas averaging more than 30.1 inches (1,019 mb.). These are the *subtropical high-pressure belts* or the *horse latitudes*.¹

The name *subtropical high* is applied especially to the centers of higher pressure within the belts. Although known as subtropical, they are considerably outside the tropics, especially in the Northern Hemisphere. The northern belt, where large land and water surfaces alternate, is more irregular than the southern belt, which is largely over water and therefore under a more nearly uniform influence. These belts are regions of variable winds, averaging light, and changing with the seasons. They are sometimes in-

¹The name *horse latitudes* is said to have arisen in the days of sailing ships from the practice of throwing overboard horses which were being transported to America, when the ship was unduly delayed by reason of the calms often encountered in these latitudes.

vaded by traveling disturbances attended by stormy winds.

The equatorial belt of low, and subtropical belts of high, pressure have sometimes been explained as the expression of a convectional circulation, air rising in the heated doldrums, moving poleward aloft in both hemispheres, being deflected eastward by the earth's rotation, and finally accumulating and settling in the belts of higher pressure, out of which winds blow toward the equator. The movements are probably not so simple and direct as this explanation implies, but undoubtedly, convectional movements something like this do occur, at least at times. These belts are, at any rate, a prominent and permanent feature of the general circulation.

Polar circle low pressures.—There is a continuous belt of very low pressure in the Southern Hemisphere between latitudes 60° and 70° . This belt overlies a water surface. In corresponding latitudes in the Northern Hemisphere there are large cold land masses, and their effect is to increase the pressure, but over the northern oceans there are well-defined areas of low pressure. These are centered in the vicinity of the Aleutian Islands in the Pacific and between Greenland and Iceland in the Atlantic. Winds from the west or southwest blow into the equatorward sides of these regions of low pressure in accordance with the pressure gradient as modified by the deflecting influences.

Polar caps of high pressure.—In the center of the Antarctic continent there appears to be a permanent cap of high pressure, but data are still inadequate to give an exact figure for the annual mean. All explorers of Antarctica have reported frequent strong, southeast winds from the interior, and this confirms the existence of relatively high pressure near the pole. In the Northern Hemisphere the cap of high pressure is probably not centered at the pole but extends from northern Greenland westward across the northern islands of Canada. Here, too, data are meager. Easterly winds blow out of these caps of high pressure.

It should be kept in mind that this generalized picture of

alternating belts of high and low pressure and the resulting winds represents average values and average movements of the air. In most parts of the world the day-to-day pressures and winds are much modified and interrupted by lesser circulations.

January and July Averages of Pressure and Winds

In previous discussions, mention has been made of the influence of the distribution of land and water on the general circulation. The importance of this factor becomes more evident when we examine the differences in pressure distribution between summer and winter, as illustrated by Figs. 58 and 59. A second factor contributing to a change of pressure as the seasons change is the seasonal variation in the amounts of insolation received.

Doldrums.—In January, the continuous equatorial belt of low pressure has its centers of lowest pressure over the land areas in the Southern Hemisphere, where it is mid-summer. Note the centers in equatorial South America, equatorial Africa, and northern Australia. In July, the belt is almost entirely north of the equator, and low pressure extends far northward over North America and Asia, with minima in northwestern India and southwestern United States. Within the doldrums the air movement is mostly from an easterly direction, but note that there is a shifting between northeast and southeast with the seasons, as the center of the low pressure moves south and north. In January, northeast winds of the Northern Hemisphere extend to, and in some cases south of, the equator. In July, winds from the Southern Hemisphere cross the equator and reach 10° to 20° north latitude.

High-pressure belts.—In January, the subtropical high-pressure belt is practically continuous in the Northern Hemisphere near latitude 30° , with somewhat higher pressure in the eastern parts of the Atlantic and Pacific than in the western parts of these oceans. In the Southern Hemisphere, where the land is warm in January, there are three

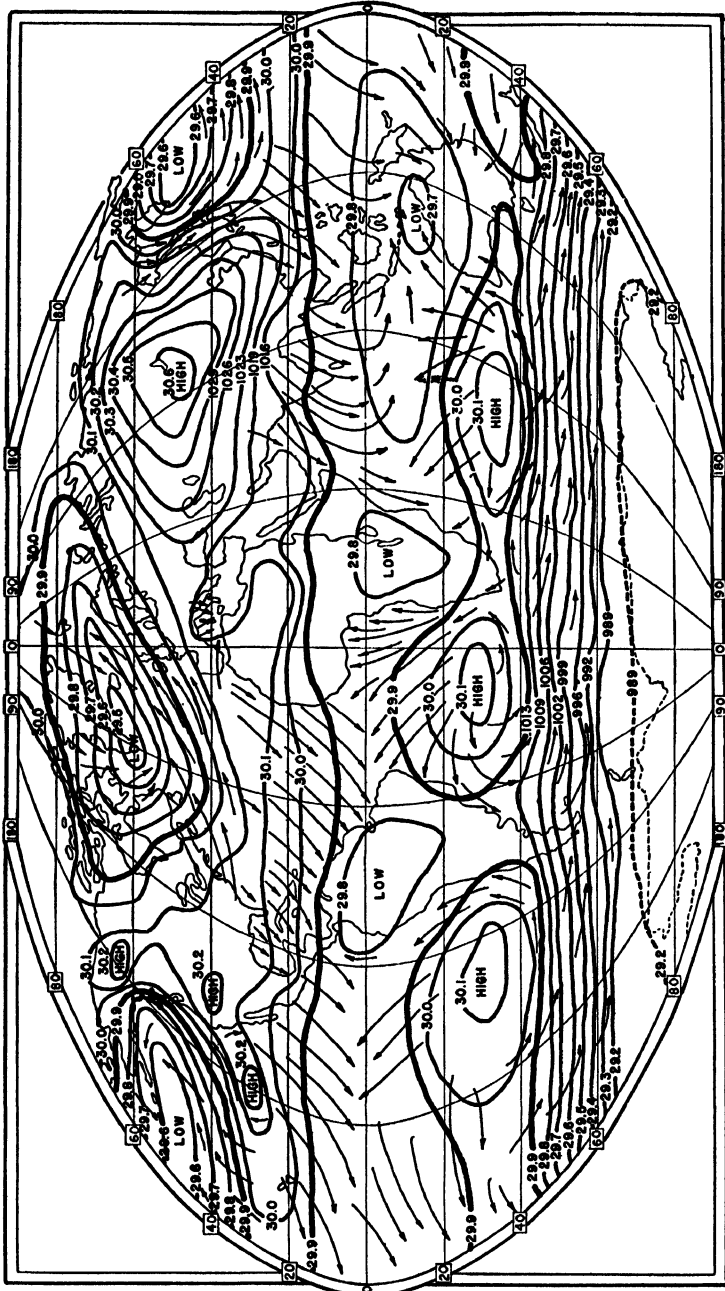

Fig. 58. Mean January Pressure and Wind Direction, World. Base map by permission Denoyer-Geppert Co.

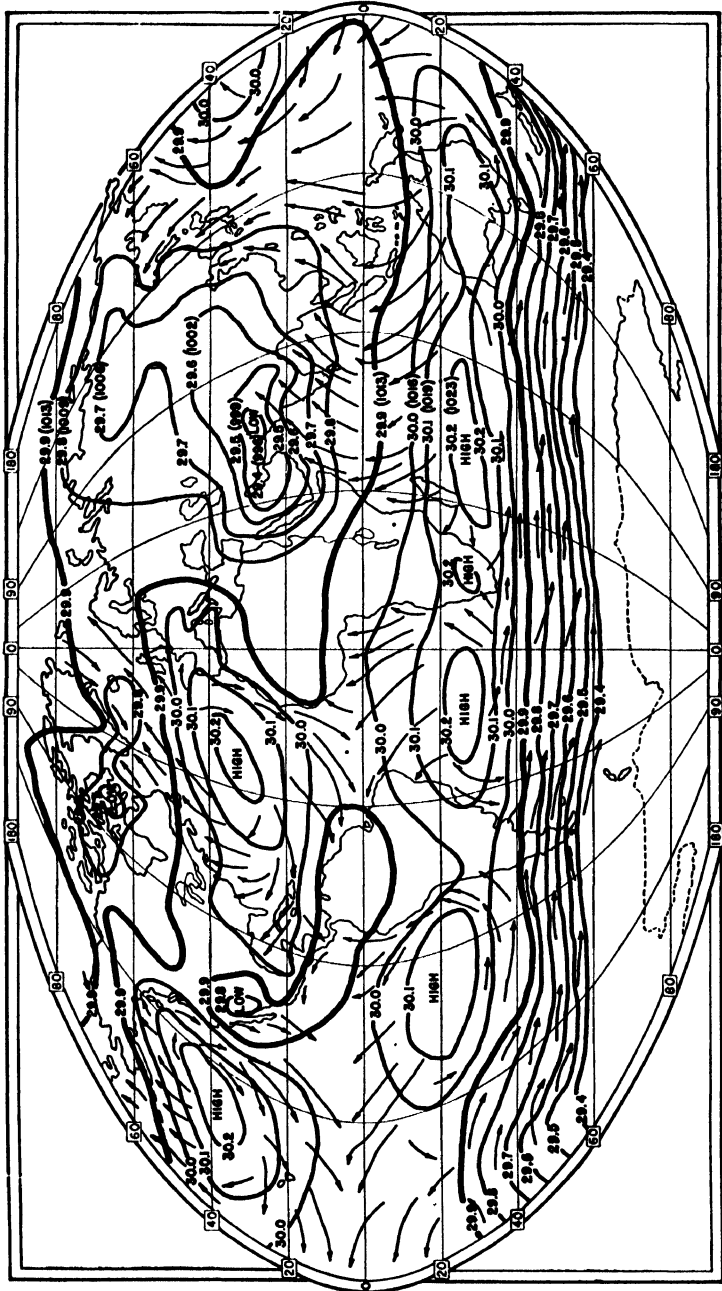

Fig. 59. Mean July Pressure and Wind Direction, World. Base map by permission Denoyer-Geppert Co.

maxima over the relatively cool oceans, in each case, where the ocean water is abnormally cold for the latitude because of cold ocean currents moving northward. In July, centers of high pressure are well developed in the cool ocean areas of the Northern Hemisphere, but south of the equator, although pressure has risen over the land areas, the centers of highest pressure remain over the oceans as in January. The small proportion of land in these latitudes is not sufficient to reverse the pressure distribution as in the northern half of the world.

Trade winds.—Between the doldrums and the belts of higher pressure, there are steady, moderate winds, known as *trade winds*, blowing out of the high pressure areas toward the equator. As they move equatorward, they are deflected to the west and become *northeast trades* in the Northern Hemisphere and *southeast trades* in the Southern Hemisphere. They are best developed on the eastern sides of the oceans, in air flowing out of the oceanic peaks of high pressure. In these situations they are remarkably constant in direction and velocity, blowing almost uninterruptedly, day and night, winter and summer, with a velocity of 10 to 15 miles per hour. Such steady winds do not occur over large land areas, and even in the western portions of the oceans the trades are less constant. They are confined to the belt between 30° north and 30° south latitude.

Aleutian and Iceland lows.—In contrast to the continuous belt of low pressure near the Antarctic circle, there are two distinct areas of low pressure near the Arctic circle. That in the north Pacific is known as the *Aleutian low*, and that in the north Atlantic, the *Iceland low*. Both of these are strongly developed in winter, for each is in a region where the temperature of the water is raised by warm ocean currents, and each is near large land masses that become very cold. In summer, Alaska and Siberia become decidedly warmer than the adjacent waters, thus reversing the temperature gradient. This is followed by a reversal of the pressure gradient; the center of low pressure moves to

the continents, and the Aleutian low practically disappears. In the Atlantic area, Greenland, Iceland, and northwestern Europe remain comparatively cool during the summer; they do not warm sufficiently to destroy the Iceland low. The Aleutian and Iceland lows exercise an important influence on the weather of North America and of Europe, respectively, as will be noted later.

Continental highs of winter.—As indicated in the preceding paragraph and as shown in Fig. 58, the Aleutian and Iceland lows are separated in winter by areas of high pressure over the continental interiors. The regions of highest pressure are Mongolia in the center of Asia, and the Mackenzie valley in northwestern Canada. These are regions of intense winter cold, and the high pressure is largely a response to monsoonal influences. In other words, the contrast between the abnormally warm waters of the bay of Alaska and the north Atlantic, on the one hand, and the very cold continents, on the other hand, results in the development of the strongly contrasting areas of high and low pressure in these latitudes.

Prevailing westerlies.—Winds blowing out of the poleward sides of the subtropical belts of high pressure are deflected as they move into higher latitudes and become southwest winds in middle northern latitudes, and northwest or west winds in middle southern latitudes. These are known as the *prevailing westerlies*. They begin about 40° north and south latitudes and extend to the subpolar lows, in the vicinity of the polar circles. They are subject to many interruptions by storms and irregular, intermittent winds near the surface of the earth. At the cirrus cloud level they come more steadily from a westerly direction. These winds persist throughout the year but are stronger in winter, especially in the north Atlantic and north Pacific, where the deepening of the Aleutian and Iceland lows and the building up of high pressure over the continental interiors create steep pressure gradients. The area between latitudes 40° south and 50° south is almost entirely water,

and the prevailing westerlies are strong and persistent throughout the year. The region is called by sailors the "roaring forties."

Polar easterlies.—Winds blowing out of the Antarctic cap of high pressure and deflected to the left are known as *polar easterlies*. While there are no winds blowing regularly from the area around the north pole, there are prevailing out-flowing easterly winds from Greenland, and in winter, from the cold centers of Siberia and Canada also, and these may be considered as representing the polar easterlies of the Northern Hemisphere. Recent observations in northern Alaska show that the prevailing winds are from the east below 3,000 meters (about 2 miles), and from the west above that height.

Polar front.—The relatively warm prevailing westerlies meet the cold polar easterlies or the cold air from continental interiors, along an irregular shifting boundary which is known as the *polar front*. The polar front is the margin of the cold air as it advances toward warmer latitudes. From day to day this boundary changes its position, swerving far northward or southward, especially in the Northern Hemisphere in winter. At times warm air swings north in the Atlantic to northern Scandinavia and Spitzbergen; at times cold air streams southward from northern Canada or northern Eurasia, chilling the Gulf coast of the United States, or the Mediterranean coast of Europe. Perhaps some of this air from polar regions finally enters the trade winds and reaches the equator. It is along this moving polar front that the storms, or barometric depressions, characteristic of the weather outside the tropics, develop.

Upper Air Circulation

Our direct knowledge of the pressure and movements of the upper air comes from observations of cloud movements, especially of the cirriform clouds, and from the records of instruments carried aloft by balloons, kites, and airplanes. Additional data are accumulating from these sources, but as

yet our knowledge of the normal circulation of the upper air remains incomplete, and to get a picture of the distribution of pressure and winds at different levels it is necessary to supplement the observations with calculations based on assumed lapse rates. The following brief statements with reference to upper air circulation are consistent with observed and calculated values.

Upper troposphere.—At heights of $2\frac{1}{2}$ to 5 miles (4–8 km.) the pressure distribution is much simpler than in the surface layers. In lower latitudes there is a belt of high pressure, with maxima near the tropics of Capricorn and Cancer, and there are areas of low pressure with closed isobars around each pole. Two simple wind systems result from this pressure arrangement. These are (1) an east-to-west circulation in equatorial regions over about one half of the earth, and (2) a west-to-east movement around the poles in the poleward half of each hemisphere.

Antitrades.—The height to which the trade winds extend varies in different parts of the world, and at the same place at different times of the year. The observed heights range between 3,000 and 13,000 feet. Above the trades but below the upper air circulation, a direct reversal of the wind direction has often been observed. These winds, from the southwest over the northeast trades and from the northwest over the southeast trades, are known as the *antitrades*. The name was given under the supposition that these winds represent the return portion of a convectional circulation between the doldrums and the subtropical belts of high pressure of which the trade winds are the lower portion. This assumption is probably justified in part, but the antitrades are not so constant as the trades and not in fact always and everywhere present over them.

Latitudinal Interchange of Air

Mixing processes.—It is evident from the foregoing discussion of the general circulation that the air is not shut off into separate compartments but that much transposition

and interchange of air occur from one pressure belt to another. Some of the processes by which this mixing is accomplished are: (1) by the shifting of the center of the doldrums north and south of the equator, thus transferring air from one hemisphere to the other; (2) by the circulation of the air around the semipermanent centers of high and low pressure as they gradually change their positions with the changing seasons. For example, the centers of high pressure in the Northern Hemisphere change from the continents in winter to the oceans in summer, involving a change in the direction and the destination of large masses of air; (3) by the movement of great quantities of cold air equatorward and of warm air poleward along the polar front as it rapidly alters its position; (4) by the rising and settling of air in various parts of the world, displacing surface air with air from aloft, and involving both in new circulations.

By such processes the air is kept mixed to a considerable extent, and this interchange of air has an important equalizing effect on the temperature. It is true that masses of warm air do accumulate in equatorial regions, and cold air in polar regions, and the mixing is not perfect, but if it were not for the winds, aided by the ocean currents, the equatorial zone would become unbearably hot, for it receives more heat than it radiates, and the temperature of the polar regions would fall nearly to the absolute zero in the long polar nights.

The Indian monsoon.—In the northern Indian Ocean and across India there is a complete reversal of wind directions with the seasons. This Indian monsoon is a striking example of the transfer of air across the equator with the migration of the sun. See the charts of January and July pressure and winds. In the winter months pressure is high over interior Asia, and the doldrums are south of the equator. Air therefore moves from Tibet across India and the northern Indian Ocean into the Southern Hemisphere during these months. The air is cool, because of its origin, and dry

as it descends the southern slopes of the Himalayas. This is the northeast monsoon, during which the Indian peninsula enjoys moderate temperatures with very little rain.

In the summer season there is a continuous pressure gradient from the high pressure belt in the southern Indian Ocean to the low pressure area in northwestern India. The southeast trades cross the equator and are then deflected to the right, becoming the southwest monsoon of India. As the warm, moist air from equatorial waters moves northward toward the Himalayas, it is forced up slope, and heavy rains result. This is the hot, rainy, summer monsoon upon which the crops depend. The heat is less oppressive than it would otherwise be, because of the steady, moderate breeze. Between seasons, in spring and again in autumn, while pressure distribution is changing, winds are light and variable and also hot and humid, and then living conditions are quite uncomfortable.

The total movement across the equator.—Not only in the Indian monsoon but also in the trade winds in the Atlantic and Pacific Oceans there is movement of air across the equator, northward in the northern summer, and southward in the southern summer. This movement of surface air to the warm hemisphere must mean that the pressure is higher in the cold hemisphere, and hence that there is more air over the winter half of the globe than over the summer half. The average pressures obtained by observation show this to be true, and Shaw² calculates that the mass of air in the Northern Hemisphere in January is ten trillion tons greater than in July. This is less than one five-hundredth of the total mass of the air. While surface air tries to escape the rigors of winter by traveling to the warmer half of the earth, it is more than replaced by air moving in at higher elevations and settling over the cold continents.

Sources of energy.—To move the masses of air involved

² Shaw, Sir Napier, *Manual of Meteorology*, Vol. II, p. 212. The Macmillan Company, New York, 1928.

in the general circulation requires an immense amount of work. Air, like all other material substances, has inertia; force is required to start it moving. After motion begins, friction and turbulence oppose the motion, reducing the velocity of the wind, tending to break down the circulation and to make the air flow across the isobars into the areas of low pressure. Despite these opposing forces, such great currents of air as the prevailing westerlies and the trade winds continue undiminished.

The following four sources of energy are available to accomplish this work: (1) *Insolation*.—The energy received from the sun results in an unequal warming of the air, largely because of an unequal warming of surfaces with which the air comes in contact. This is due in the first place to the differing amounts of insolation received, but the character of a surface also largely influences its temperature. (2) *Gravitation*.—The unequal heating of the air produces differences in its density, and the force of gravity then causes the heavier air to seek the lower level, displacing the lighter air. (3) *Condensation*.—The latent heat released by the condensation of water vapor supplies much energy and is chiefly responsible for vigorous upward convection. (4) *Rotation*.—The rotation of the earth results in changing the direction of the moving air and is responsible for the great amount of eastward and westward movement found in the general circulation. These are the forces which act together to produce the movements of the air, and which, as limited by inertia and friction, result in maintaining the general circulation as we find it.

The primary sources of energy are the sun and gravitation, which together cause convective movements of the air. Sir Napier Shaw expresses it thus: "There is nothing but thermal convection to act as the motive power for every drop of rain that ever fell and for every wind that ever filled a sail or wrecked a ship since the world began."³

³ Shaw, Sir Napier: *The Air and Its Ways*, page 99, Cambridge University Press, London, 1923.

Summary

The daily and seasonal changes of pressure and also the geographic variations of pressure give evidence of the complexity of the air's movements and the inequality of its distribution. If it were possible to follow and explain all these movements and the accompanying changes in the distribution of the air, most of the problems of meteorology would be solved.

Notwithstanding the involved and intricate character of atmospheric movements, it is possible to make a simple, though very much generalized, statement of the average distribution of pressure and winds near the surface of the earth. High and low pressures are arranged roughly in alternating zones. First, relatively low pressure prevails in an equatorial zone, which extends poleward into middle latitudes over the continents in summer. Second, on each side of the equatorial zone are the zones of the subtropical highs, with peaks over the oceans. Between these are the northeast and southeast trade winds, the steadiest winds of the globe, particularly constant in the eastern halves of the Atlantic and Pacific Oceans. Over the trade winds, opposite antitrades are frequently found.

The third zone is that of low pressure in the vicinity of the polar circles, quite uniform and very low in the Southern Hemisphere, interrupted in the Northern Hemisphere and mainly represented by the Aleutian and Iceland lows in winter and by summer lows over Asia and North America. Between these and the subtropical belts of high pressure, the westerlies prevail, subject to frequent interruption by moving disturbances in the atmosphere. Finally, there is a polar cap of high pressure over Antarctica, and prevailingly high pressure from northeastern Canada to northern Greenland. Polar easterly winds blow out of these pressure peaks, meeting the prevailing westerlies along a polar front which often invades lower temperate latitudes. In the upper troposphere there are maxima of pressure in the lati-

tudes of the tropics and minima around each pole, giving easterly winds at heights of 5 to 8 miles over the middle half of the globe and westerly winds in the polar half of each hemisphere.

The general circulation, as thus very simply outlined, is greatly disturbed and confused by many lesser movements, such as the seasonal shifting of the air between continents and oceans, the extensive latitudinal movements of the polar front, vertical movements, and the transfer of air across the equator in the trade winds and the Indian monsoon. Surface air moves to the summer side of the equator; the total mass of air is greater over the winter hemisphere. Friction and turbulence would soon bring all air movements to a stop, if energy were not continually supplied to keep them going. They are kept going by differences in weight brought about by temperature differences. The rotation of the air along with the earth furnishes much energy to moving air but does not itself produce winds.

Problems

1. Illustrate by a diagram the general pressure and wind belts of the earth.
2. Describe the characteristic weather of the doldrums; of the trade winds; of the subtropical highs; of the prevailing westerlies.
3. Determine the latitude and longitude of the centers of low pressure in January and in July.
4. Determine the latitude and longitude of the peaks of high pressure in January and in July.
5. What is the difference in the weight of air over the United States in winter and in summer, assuming that the average pressure is 30.1 inches in winter and 29.9 inches in summer? (A cubic inch of mercury weighs 0.49 pound. The area of the United States is approximately 3,026,000 square miles.)

CHAPTER VIII

The Secondary Circulation

The general circulation may conveniently be regarded as a background upon which are superimposed many smaller disturbances and irregularities. It is like the flow of a river with many eddies and cross currents. Some of these lesser movements, such as sea and land breezes, katabatic winds, and monsoons, have been noted. There are irregularities of flow of quite another type, to which the name *secondary circulation* is particularly applied. These are traveling disturbances, of which some originate along the polar front and are chiefly responsible for the day-to-day changes in weather in temperate latitudes, and some are severe storms which begin in tropical regions.

Weather Maps

Little was known about the characteristics and behavior of these moving wind systems until about one hundred years ago, and before discussing them here, it is advisable to note the device by which much of our knowledge about them has been gained.

Synoptic charts.—Between 1820 and 1850, various men in Germany, England, and America began to collect information about simultaneous atmospheric conditions over a considerable area and to enter that information on outline maps of the area. They used these maps as a means of studying the behavior of the atmosphere and the relations of the weather in one place to that in another place, much as one uses a geographic map to learn the natural features or political subdivisions of an area, and their relations. At

that time, the information was necessarily collected slowly, and the conditions were long past before the maps were made. The study of such maps proved very fruitful, however, and first gave definite information about the nature of traveling disturbances. Such maps are called *weather maps* or *synoptic charts*, synoptic because they afford a synopsis or summary of the weather over a large area.

Soon after the use of the telegraph became widespread, attempts were made to issue daily charts showing atmospheric conditions of the date of issue, because it was seen that with such information, quickly collected and charted, inferences could be drawn about future changes in the weather. This was the beginning of weather forecasting on a scientific basis. The making and publishing of weather forecasts were first begun by private enterprise, starting thus in England, Holland, and the United States between 1849 and 1869. These early attempts to map and forecast the weather aroused much scientific attention and popular interest. The forecasts had some notable successes, especially in warning of the approach of severe storms, and the public began to demand this service. The practical value of the maps and the forecasts based on them having been thus proven by trial, the duty of collecting and charting the information and making the forecasts was gradually assumed by governmental agencies. The collection of meteorological and climatological data and the issuance of weather forecasts is now recognized as a necessary governmental function throughout the world. The first government organization to publish weather maps and forecasts was France, in 1863. In the United States, maps were begun officially on January 1, 1871, and have been issued continuously since that time.

Weather maps, such as are now in daily use throughout the world, are outline maps of a large area, upon which weather conditions at a specified time at a large number of observing stations are indicated by figures, symbols, or lines. See Figs. 60, 61, and 62. Data are entered near each re-

porting station to show amount of clouds, wind direction and force, state of weather, temperature, dew point, pressure, pressure tendency and change in last three hours, amount of precipitation, visibility. Isobars and, sometimes, isotherms are drawn to give a picture of the distribution of pressure and temperature. (Isobar was defined in the previous chapter. Analogously, an *isotherm* is a line drawn through points of equal temperature.) The areas on which precipitation has fallen during the past 24 hours are often indicated by shading. At forecast centers and major airports in the United States such maps are prepared four times daily, representing conditions observed at 1:30 and 7:30 A.M. and P.M., 75th meridian time.

Making a weather map.—The making of a weather map requires the work of a large organization. First, there must be, over a large area, a well-distributed network of meteorological stations at which competent, trained observers make synchronous observations of the weather. Second, the data so obtained must be collected rapidly by telegraph or radio, at the centers where maps are to be prepared. Third, the information so collected must be quickly mapped to show the distribution of pressure, temperature, and precipitation. Fourth, from this picture of the weather the forecaster must make his interpretations and inferences. Finally, the forecasts and maps must be promptly printed and distributed if they are to serve their purpose of informing the public and giving the news of the weather to those interested.

Value of the weather maps.—The entire system of short-period weather forecasting is dependent on the synoptic chart. From the picture of the existing weather thus set before him, the meteorologist is able to estimate with considerable accuracy the changes that will occur in a given area during the next 24 to 48 hours. He can do this for a distant area as accurately as for his own locality, if he has become thoroughly familiar with the behavior of the weather in the area. This is true because he makes his forecast not by looking at the sky nor observing the

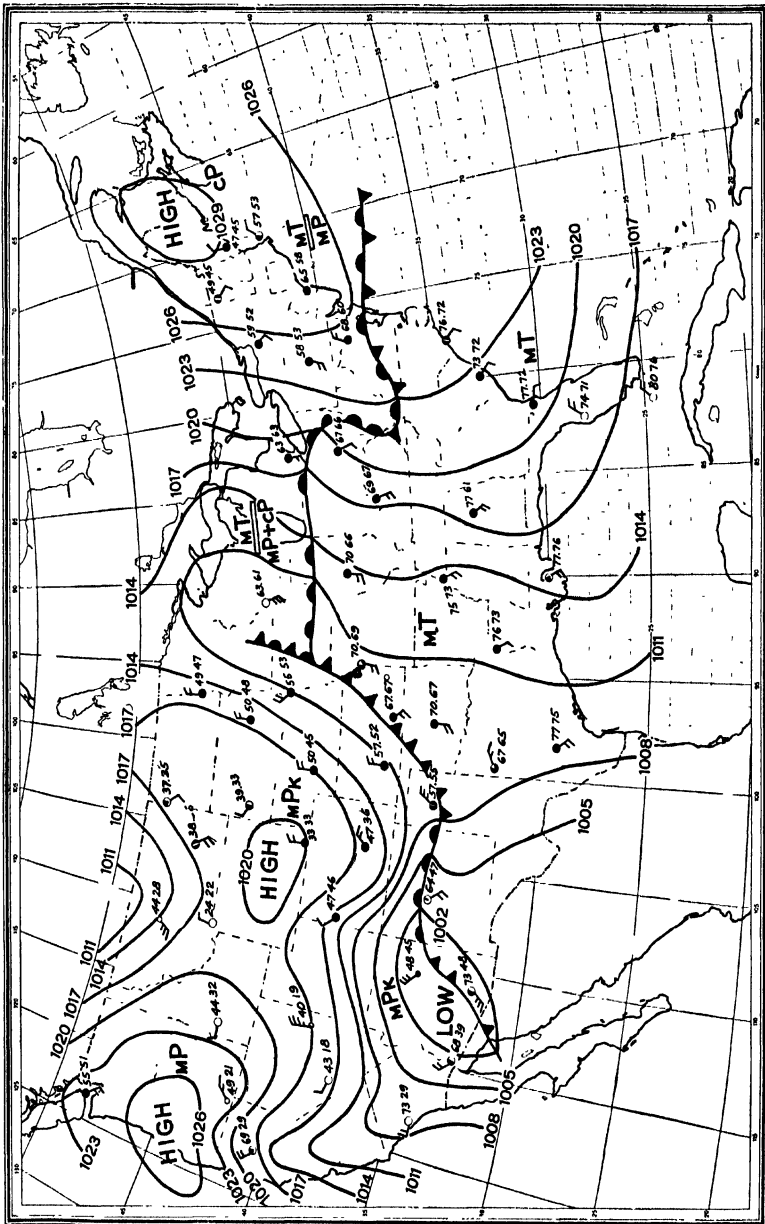

Fig. 60. Weather Map, October 3, 1941. Pressure in millibars. Temperature and dew point at right of station circles in °F.

stationary front; cold front; warm front; occluded front

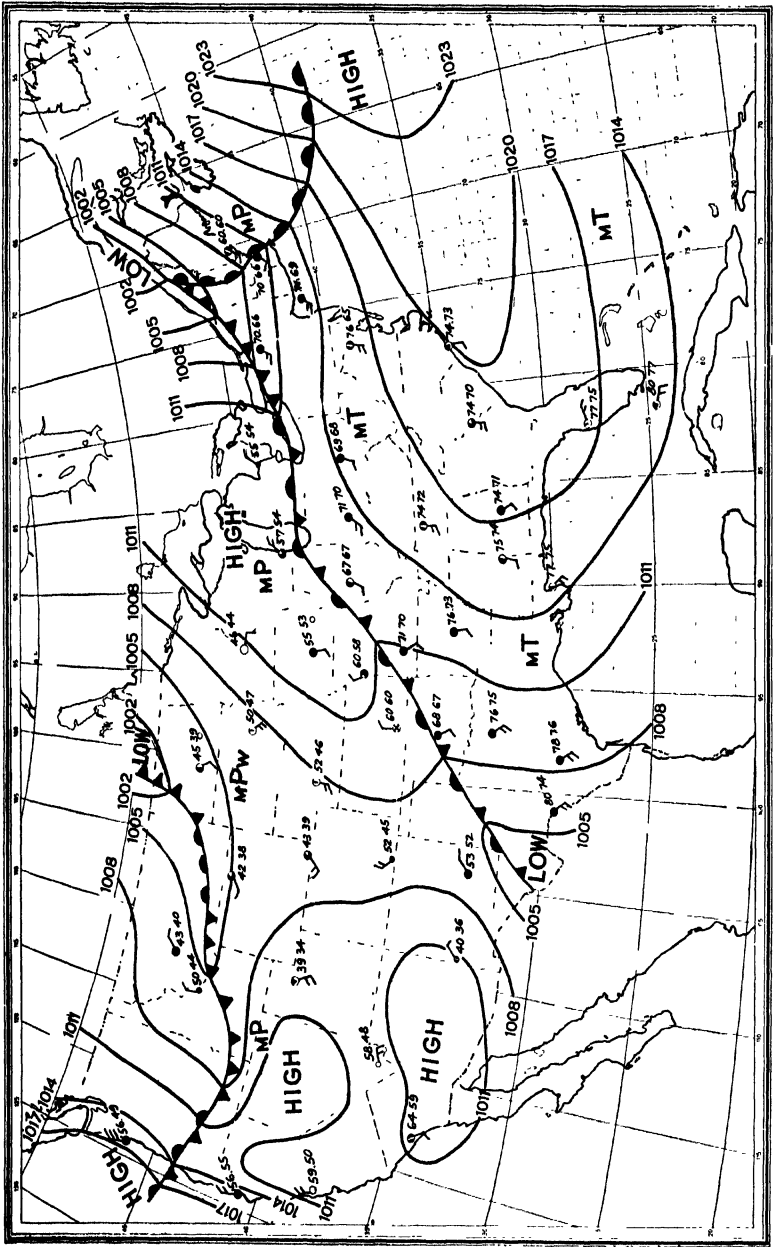

Fig. 61. Weather Map, October 4, 1941.

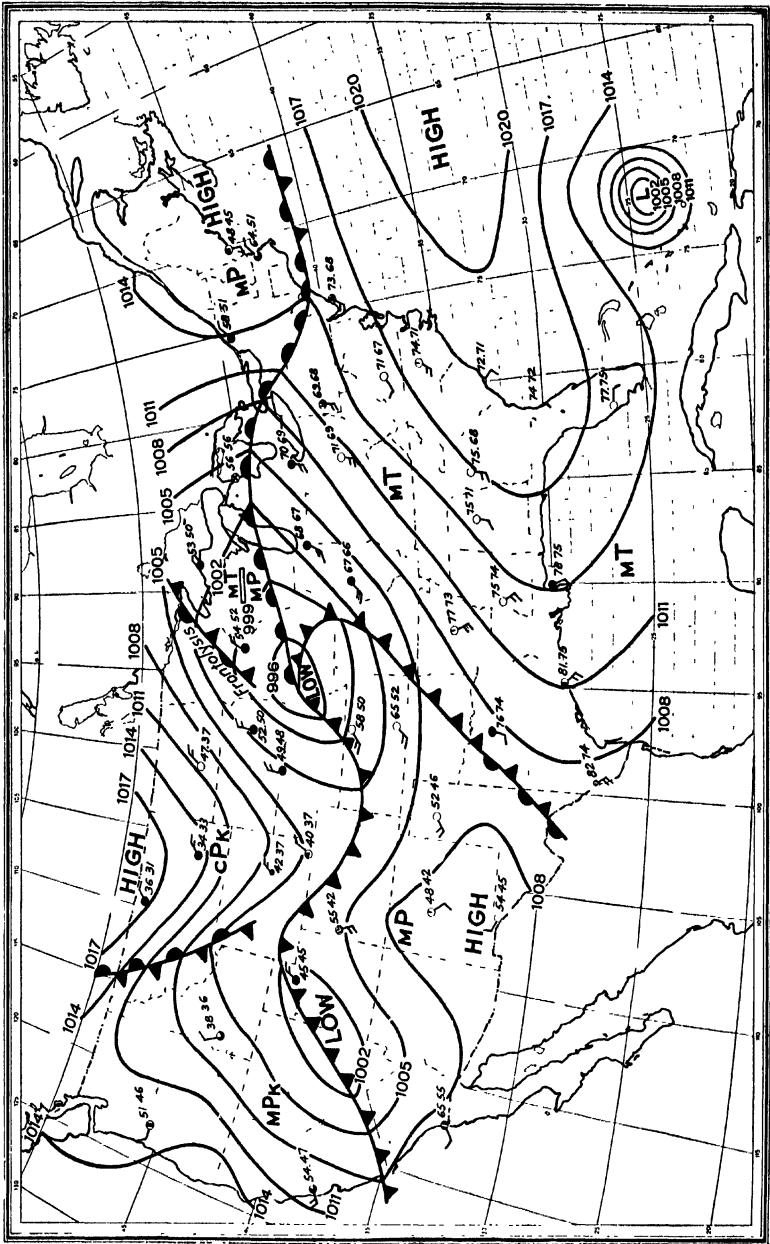

Fig. 62. Weather Map, October 5, 1941.

“weather signs” but by a study of the map. His inferences are based partly upon known physical laws governing the behavior of the atmosphere and partly upon familiarity with previous maps, that is, upon a knowledge of how the weather has behaved before under similar conditions.

Weather maps have been available for a period of more than 60 years. During that time they have been carefully examined, studied, and classified, by many students. They have proven themselves indispensable in the making of weather forecasts and in the scientific study of many meteorological problems. They have not, however, completely fulfilled early expectations. They have not led to the explanation of all the phenomena of the air nor to the development of perfect weather forecasting. Much has been accomplished by their aid, but much remains to be done before a complete understanding of the atmosphere is reached.

Barometric Depressions

If we examine even a short series of weather maps, we find that the isobars do not have the regularity of spacing and of direction that they show in the charts of the general circulation. Instead, the isobars are disturbed by lesser irregularities and assume various shapes and patterns, which change their locations and alter their outlines from day to day. The two patterns of most frequent occurrence and of greatest importance in their effect on the weather are the depression and the anticyclone.

Characteristics of depressions.—The barometric depression is marked by a series of roughly circular or oval isobars inclosing an area of low pressure, that is, with pressure decreasing from its outer rim to its center. See Fig. 63. Such a system has long been known in meteorology as a *cyclone*, or an *extratropical cyclone*. The word *cyclone* carries the idea of a revolving storm, and the names *depression*, *cyclonic depression*, or *low*, seem preferable, because it is now known that such a traveling disturbance is not

composed of a revolving mass of air, and also because the name cyclone has been applied to storms of a different nature (the tropical disturbance and the tornado, to be noted later). Because it is so well established in meteorological literature, the name cyclone is sometimes used in the following discussion, and when so used, it has the same significance as depression or low.

Individual depressions differ greatly in size, ranging in diameter from 100 to 2,000 miles, the average diameter in the United States being 1,000 miles or more. They also vary in form from approximate circles to much elongated ovals. The ovals are sometimes so much flattened at one end as to receive the name of *V-shaped depressions* and sometimes become so broad and shallow that they are called *troughs* of low pressure. When thus greatly elongated, they lose some of the features generally regarded as characteristic of depressions. The typical round or elliptical low has, near the surface of the earth, moderate winds directed inward and around the center of low pressure, making angles of 20° to 40° with the isobars. (See surface winds, page 150. The direction of movement is counterclockwise in the Northern Hemisphere, responding to the influence of the earth's rotation, and following Buys-Ballot's law. Such a movement of air around a center of low pressure is called a *cyclonic circulation*. (Fig. 63.)

In the Northern Hemisphere this movement usually results in a warm sector in the southern quadrant of a low, where the winds are from a southerly direction, and a cooler area in northern and western portions where the winds are easterly, northerly, or northwesterly. Cloudiness and precipitation are usually associated with the movement of such

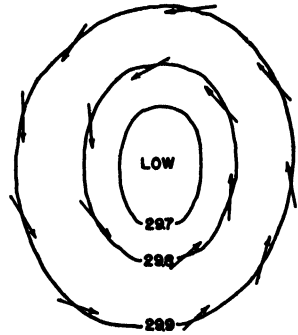

Fig. 63. Conventional Barometric Depression and Cyclonic Circulation in the Northern Hemisphere.

a cyclone. It should be understood that these are much simplified statements made for the purpose of identifying these disturbances of the atmospheric circulation. A more detailed account of their nature and their relations to the weather is presented later.

Source regions.—Depressions of this character originate anywhere outside of the tropics, but more frequently in high latitudes. They are more numerous and better developed in winter than in summer. In the Northern Hemisphere many begin in and move from the vicinity of the stationary and semipermanent Aleutian and Iceland lows, and are regarded as offshoots of these “centers of action.” Many have their origin in the region of China and the Philippines. Others that affect the United States begin in western Canada, or in western and southern portions of the United States. In the United States, lows are given the following names, indicating their place of origin or first appearance on the weather map: Alberta, north Pacific, south Pacific, northern Rocky Mountain, Colorado, Texas, east Gulf, south Atlantic, and central. Of these the Alberta type is much the most frequent, and those that come from the east Gulf and south Atlantic regions are the least numerous. Lows from the different regions have somewhat different characteristics and paths. A *secondary low*, having the same general characteristics, frequently develops on the equatorward side of the primary depression. This is especially likely to occur in elongated oval or V-shaped depressions.

Movement of depressions.—The general direction of motion is from west to east, with frequent trends to southeast or northeast. Each individual depression, in fact, seems to select its own path as it makes its way eastward. There is no fixed path which all follow, but there are general tracks more frequented than others. The lows originating in the western Pacific move northeastward by way of Japan and the Kurile Islands to the Bay of Alaska. From there they move southeastward, as do those that have their beginning

in the Aleutian low, to enter the continent as north Pacific or Alberta lows. Across North America there are three predominant paths: (1) eastward along the border of the United States and Canada; (2) from western Canada or the north Pacific southeastward into the Mississippi Valley,

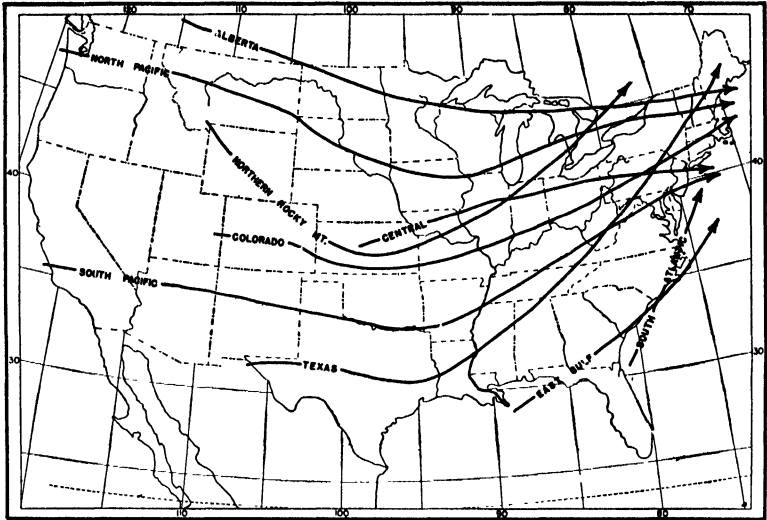

Fig. 64. Typical Paths of Depressions Appearing in Various Regions of the United States. (After Bowie and Weightman.)

and thence northeastward to the Great Lakes, the New England states, or the St. Lawrence Valley; (3) from the southwestern region eastward to the Mississippi Valley and then northeastward to New England. Typical paths of the nine named types are shown in Fig. 64.

Some of the cyclones from North America cross the Atlantic Ocean to Europe. Most of these, together with those that begin in the north Atlantic, move northeastward across or north of the British Isles into Russia. Some curve farther south and enter Europe by way of France. The rates at which the cyclones advance are variable and individual, like their paths. The average movement is 20 to

30 miles per hour. The higher averages occur in winter and the lower in summer.

By thus giving different names to the depressions originating in different regions, and by following individual disturbances for considerable distances, we seem to treat them as independent entities, but the fact should be kept in mind that they are merely comparatively small irregularities in the larger, more orderly movements of the air. They are not independent of the general circulation but interruptions in its symmetry. They therefore move toward the east with the general eastward movement of the entire lower atmosphere in the middle latitudes. They are carried along in the prevailing westerlies. Irregularities of flow also cause the individual disturbance to turn aside from a direct west-to-east movement in many cases. Its apparently capricious wanderings are influenced not only by the pressure gradients around it at the surface, but also by pressure changes in the upper levels of the air.

Anticyclones

The other characteristic pattern of isobars to be observed on almost any weather map is the *anticyclone* or *high-pressure* area. An anticyclone is an area inclosed by circular or elliptical isobars, with high pressure at its center and with spirally outflowing winds, turning clockwise in the Northern Hemisphere and the opposite direction south of the equator. This system of diverging winds constitutes an *anticyclonic circulation*, illustrated in Fig. 65. The area within the closed isobars is often larger than in depressions, and the isobars are farther apart. The winds are light, and calms are frequent, in conformity with the small pressure gradient. There is usually little cloudiness. In the Northern Hemisphere the eastern half of a traveling high is relatively cold at the surface, with northerly winds, and the western half warm, with southerly winds.

Tracks and velocities.—The movement of anticyclones is similar in general to that of cyclones, highs and lows

often following each other in regular succession. This is particularly true in middle latitudes of the Southern Hemisphere, where the surface is largely a water surface. There, the regularity is such as to form a wave-like procession around the earth. Over the large land areas of the Northern Hemisphere, highs are more likely to become stationary, or nearly so, than are lows, and their progress sometimes comes to resemble spreading rather than traveling. They then become isolated areas of high pressure with lows moving past them on either side. Such stagnation occurs more

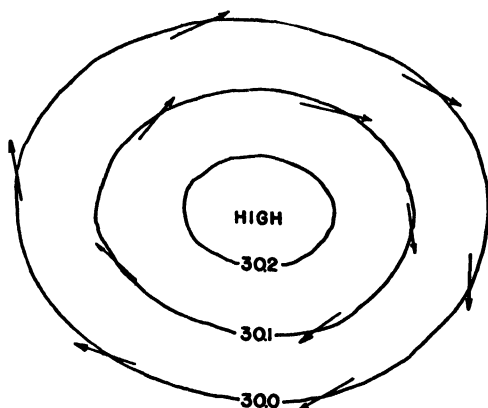

Fig. 65. Conventional Anticyclone and Anticyclonic Circulation in the Northern Hemisphere.

frequently in Europe than in America. In the former country, anticyclones often remain nearly stationary for several days or even weeks. These stationary highs are composed of relatively warm air, especially at elevations of 2 to 5 miles (3-8 km.), and frequently develop continuous cloud sheets.

The principal types of American highs, named according to their source regions are: Alberta, north Pacific, south Pacific, Plateau and Rocky Mountain, Hudson Bay. It will be noted in Fig. 66 that their average paths differ somewhat from those of cyclones, and in particular that they enter the Atlantic Ocean farther south. The depressions

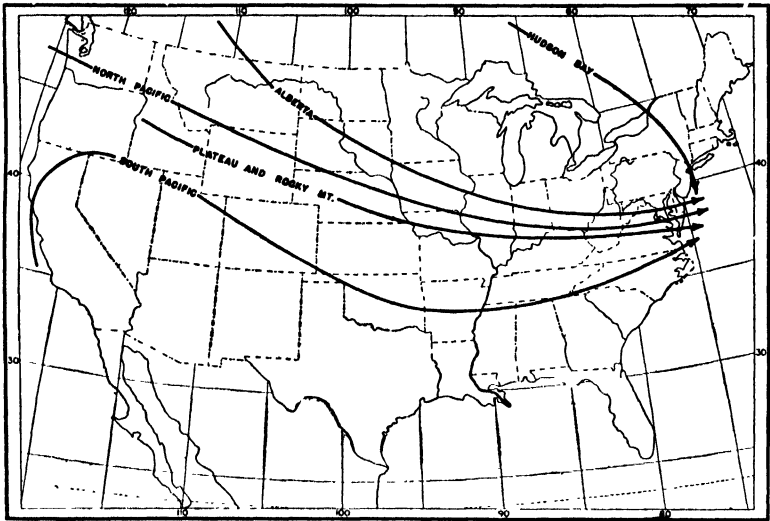

Fig. 66. Typical Paths of Anticyclones Appearing in Various Regions of the United States. (After Bowie and Weightman.)

appear to be attracted by the Iceland low; the anticyclones remain south of it.

Nature and Origin of Highs and Lows

In connection with the formation and maintenance of cyclones and anticyclones, two primary facts as to their nature are to be kept in mind: (1) In a low, air is moving inward toward a center, and some of it is being carried up and removed at the top; (2) In a high, air is added at the top and is slowly flowing out at the bottom. Any theory of their origin must account for these facts and for the supply of energy which maintains and moves them.

Convection theory.—Early attempts to explain the genesis of depressions were along the lines of convection. It was assumed that a low was a mass of warm, moist air, rotating around a center where the air was rising by thermal convection, and that the overflow formed the adjacent high. Further knowledge of the actual conditions obtaining in lows and highs shows that this explanation is inadequate

and not in agreement with the facts. Some of the reasons for the rejection of this theory are: (1) Lows are more frequent and better developed in winter, when convection is less active, than in summer; (2) They frequently begin over oceans where surface heating is negligible; (3) The depression as a whole is not a body of warm air nor of revolving air.

These facts seem to exclude local heating of the surface air as a primary cause of cyclonic depressions. Brunt has pointed out, however, certain special conditions under which the origin of a moving depression may be ascribed to surface warming. When a mass of cold air moves from polar regions into warmer latitudes and passes over progressively warmer land or ocean surfaces, the lower layers are warmed. Thus convection may begin over a large area. If the rising air is soon saturated and if the lapse rate is between the dry and the saturated adiabatic rates, the upward motion thus begun may continue to great heights and over a large enough area to initiate a characteristic depression. It should be noted, also, that *stationary* areas of low pressure frequently form over heated regions, as in Arizona in summer, and are properly called *heat* or *convection lows*.

Eddy theory.—The inadequacy of convection as a general explanation of the origin of depressions became evident about the beginning of the present century. It was then suggested that traveling highs and lows are eddies, or interruptions, in the smooth flow of the air streams of the general circulation. It was believed that these eddies were started (1) by surface irregularities of the earth, (2) by convective descent of cold air, or (3) by the meeting of currents from different directions. This latter idea was further developed by Bigelow into a *countercurrent* theory. He showed, by a theoretical discussion, that characteristic highs and lows might be produced by the meeting of winds of different directions and temperatures.

Polar-front theory.—Growing out of the countercurrent theory, and originating with the Norwegian meteorologist,

V. Bjerknes,¹ a more definite explanation of the origin of depressions and anticyclones has been developed since about 1915. Instead of a gradual, uniform change of temperature from equatorial to polar regions, Bjerknes envisages masses of cold air accumulated in polar regions and masses of warm air in equatorial and tropical regions. In the region of the prevailing westerlies these masses of cold and warm air meet and thereby form a *surface of discontinuity*, a well-marked and distinct surface of separation between the two masses. This surface is the *polar front*, across which there is a sudden change in the temperature of the air and often in its humidity. Irregularities of flow along the polar front are thought to initiate depressions, and the energy of flow of the two masses of air develops and maintains them. Some such meeting of large bodies of air of different temperatures and humidities and moving in different directions is now generally accepted as affording the best available picture of the mechanism of the origin and development of cyclonic depressions.

Ideal form of depression.—Fig. 67 indicates the process of development of a barometric depression. We assume first a current of warm air moving from the west on the south side of a cold current moving from the east, the two currents being separated by a definite surface of discontinuity, called a *front*. Then some local disturbance or irregularity of movement causes the turning of the warm air toward the cold current. This sets up a wave in the front, as shown in Fig. 67 (a), and divides it into two parts. The east portion of the discontinuity, shown by the double line, where warm air is advancing eastward and meeting colder air, is now the *warm front*. The west portion (single line) where cold air is replacing the warm air is the *cold front*. Sometimes the wave thus started moves along the polar front without further development attended by

¹ Bjerknes, V., "On the dynamics of the circular vortex with applications to the atmosphere and atmospheric vortex- and wave-motions." *Geofysiske Publikationer*, Vol. II, No. 4, 1921. Kristiania.

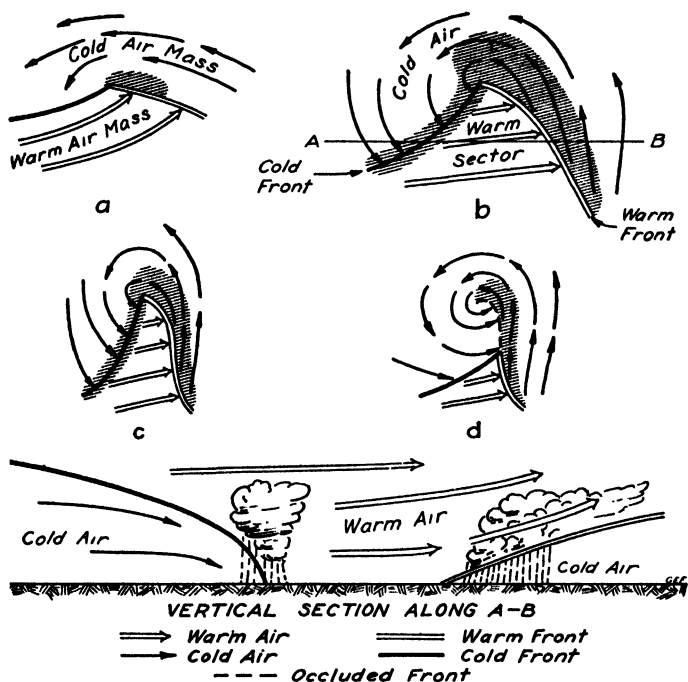

Fig. 67. Stages in the Development of a Traveling Wave Depression.

rain in the region indicated by the stippled area in (a), and ultimately dying out. More often, the curving motion having been begun, the movement of the two currents and the deflective force of the earth's rotation result in additional curvature and increased amplitude of the wave, as in (b). This represents a fully developed young depression composed of the original streams of warm and cold air, but now divided into warm and cold sectors. The cold front was recognized many years before the development of the polar-front theory and was named the *wind-shift line* or *squall line*.

Along the warm front, the warm air overtakes and overrides the colder air, and along the cold front, cold air is overtaking warm air and forcing it up. There is, accordingly, rising air along the entire surface of discontinuity, and consequently, if the air is moderately moist, there is

cloudiness and precipitation along both warm and cold fronts, as shown by the stippled areas in (b) and (c).

Occlusion.—By the process just described, the warm air is being displaced at the surface of the earth at both fronts. The cold front usually advances more rapidly than the warm, and as the depression develops the warm sector is reduced in size. In a fully developed mature cyclone, the warm sector takes somewhat the form shown in (c). This process continues until in the narrow portion of the warm sector the cold front overtakes the warm front and completely displaces the warm air at the ground. The two fronts are then combined into one, forming a long, backward-swinging *occluded front*, represented by the dotted line in (d). At some distance above the earth there is still a meeting of warm and cold air currents, and the surface along which they meet is called an *upper front*.

Secondary depressions.—It is evident that when an occlusion has occurred, the depression is beginning to die. The warm sector is being reduced and the low is filling up and diminishing in intensity, since contrasting streams of warm and cold air are essential conditions of a depression. When the development reaches the stage shown in (d), the original depression has practically disappeared. Under such conditions a secondary low frequently develops south of the original one (in the Northern Hemisphere). The beginning of a second wave is indicated in the lower part of (d). The secondary depression soon becomes independent and goes through a life history similar to the first. There may be a family of depressions, each occurring somewhat south of the previous one, and each going through a process of development, vigorous activity, and decay.

Vertical section of a depression.—The vertical section along the line *AB* of the young and active depression shows how the warm air rises over the cold air along the warm front, and how the cold air in the rear overtakes and pushes up the warm air. The slopes of the surfaces of discontinuity are exaggerated in the figure, the actual slope being

usually of the order of 1 to 100 in the case of the cold front and about 1 to 150 for the warm front. Along the warm front the air rises slowly and gradually, eastward from where it touches the ground, producing a broad belt of cloudiness and rain, often in the form of continuous sheets of cloud and slow, steady rain. Along the cold front the surface air is retarded by turbulence and the front becomes nearly vertical for a short distance above the ground. This produces an abrupt and vigorous upward motion of the warm air, resulting in the rapid development of cumulus and stratocumulus clouds, attended by squally weather, often with showers and thunderstorms. This band of cloudiness and showers is usually narrow, and soon followed by the clear, cooler, drier air typical of the cold air mass.

Movement of air in a depression.—Highs and lows move eastward, carried onward by the prevailing westerlies, often maintaining their identities for considerable periods. They can be followed and recognized from one map to the next even though the shape and arrangement of the isobars undergo marked variations. A few have been followed entirely around the globe. What is it that thus travels? It is not the same body of air, for Shaw has shown that the actual movements of given masses of surface air in a traveling depression are quite variable. Some of the air is carried along by the moving depression and finally reaches its center and rises. Much of it falls behind and never arrives at the center but moves off in other directions, especially toward the equator. None of it moves entirely around the depression. In some cases, the thing that travels and maintains its identity is probably best described as a wave advancing along the surface of discontinuity separating polar and tropical air. In other cases, especially in active, older, and occluded depressions, the moving entity assumes more of the character of a vortex opening upward.

The exact mechanism by which air is removed at the top of a depression is still unexplained. It appears from

analyses by Brunt and Shaw that strong upper currents, temporarily in excess of the gradient winds, and differing in direction and velocity from the winds of the depression, are the only possible means of getting rid of the rising air and thus reducing the pressure. Observations tend to confirm this explanation, for the movements of cirrus clouds indicate the existence of strong currents making a considerable angle with the direction of surface winds.

Origin of anticyclones.—In the original polar-front explanation of the beginning of an anticyclone, a warm current was assumed to be moving north on the west side of a cold current moving south. Any northward bulge in the cold current aided by the deflection to the right due to the earth's rotation would initiate an anticyclonic circulation, as indicated in Fig. 68, and build up high pressure at the

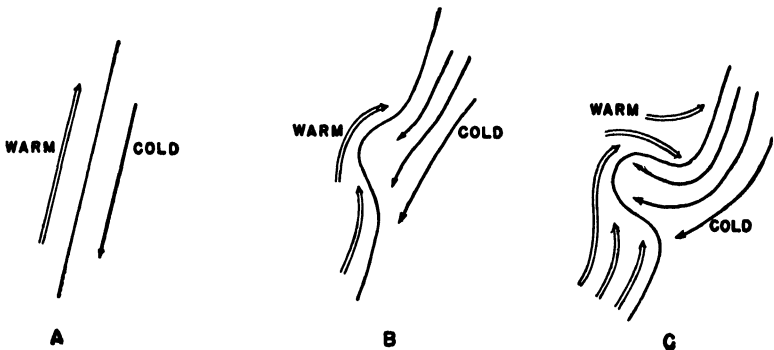

Fig. 68. Frontal Origin of Anticyclone.

center. (The explanation and figure apply to the Northern Hemisphere.)

An examination of the typical highs originating in Canada and the United States suggests a somewhat different explanation. Most of these highs follow closely in the rear of well-developed lows. The active circulation engendered by the depression, with northerly winds on its western side, brings down a surge of cold air from more northerly regions. Because the pressure is high in this cold, dense air, air is

forced out at the bottom, thus starting an anticyclonic circulation, with the aid of the earth's deflective force. At other times we may have a single large mass of cold air moving southward, irrespective of the presence of a preceding low. In polar regions in the area between the prevailing westerlies and the polar easterlies, there are often large masses of air having little movement. This quiet air becomes continually colder by radiating its heat to the cold earth and the clear skies. Consequently, it settles, the isobaric surfaces bend downward, other air moves in above it, and the pressure increases. When the pressure becomes too great, a portion of this cold air breaks loose and flows southward, forming a tongue or wedge of cold air protruding into the warm westerly winds. (See Fig. 69). This puts an obstruction across the flow of the westerlies, reducing the pressure on the eastern side of the wedge, forming a depression there, and piling up the air on its western side to form an anticyclone.

We are thus offered three slightly different pictures of the origin of anticyclones, but all three represent the same general process. Each signifies an interaction between warm

and cold bodies of air. This is the fundamental cause of both cyclones and anticyclones, but in neither case is it yet possible to describe the physical processes in complete detail.

Two types of anticyclones.—Highs crossing the United States and Canada begin as surges or wedges moving southward from polar regions and may be regarded as moving masses of cold air in the lower troposphere. Their depth is ordinarily only 1 or 2 miles ($1\frac{1}{2}$ –3 km.) but sometimes

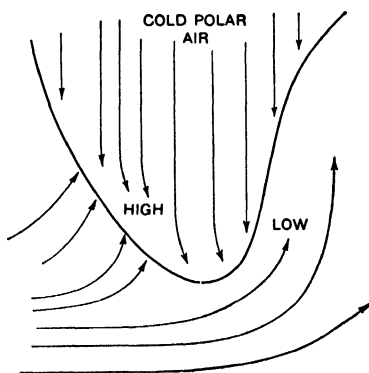

Fig. 69. Wedge of Cold Air Invading a Warm Current. A cyclonic circulation is beginning on the east, and an anticyclonic on the west.

greater. In winter there is frequently a stagnant high over the plateau region of western United States, but the typical anticyclone of the United States is a shallow, moving high. In Europe the highs originate as moving anticyclones, but many of them develop into large, nearly stationary, and relatively warm areas. The lapse rate in these stationary anticyclones is less than in depressions in the troposphere as a whole, indicating the presence of descending air from the top of the troposphere to the earth's surface, and the tropopause is 2 or more miles (3-4 km.) higher than in depressions. Hence the air in the troposphere above these anticyclones is warm as compared with air at the same elevation in depressions, but the stratosphere is higher and colder. The descent through the troposphere appears to be due to the pressure of the cold, dense air in the stratosphere. Thus, it seems that the cold, active highs characteristic of American weather are confined to the lower atmosphere, but that the warm, persistent highs of Europe may be maintained by changes occurring in the stratosphere.

Mass Movements and Energy Sources

Modern theory regards the conflict between warm and cold air as the fundamental fact in the secondary circulation. In the highs and lows of the weather map, we are not dealing with revolving storms but with disturbances of the pressure caused by the meeting of air masses. Air masses take the leading rôle in the drama of the weather, and cyclones and anticyclones are relegated to secondary parts.

Air masses.—An air mass may be defined as a large body of air of considerable depth and of nearly uniform physical properties, especially as regards its temperature and its moisture content. Such masses are formed over large uniform areas of land or water surface where the wind movement is light. Under these conditions the air to considerable heights gradually takes on uniform characteristics,

approaching those of the surface over which it lies. The warm waters of the Gulf of Mexico and the Caribbean Sea, and similar areas in the Pacific Ocean between Lower California and Hawaii, are areas over which great masses of warm air accumulate. These are regions of light winds, on the edge of the trade wind belt. The snow- and ice-covered area comprising northern North America and the adjacent portions of the Arctic Ocean is the source of nearly all the very cold air masses that affect the United States and Canada. Observations made during the international polar year (August 1932–August 1933, inclusive) show that the movement of air in northern Alaska is 30 per cent to 40 per cent less than in the United States and that there are few individual velocities much above the average. The region is therefore favorable to the accumulation of cold air masses. Another source region of polar air masses is in the north Atlantic Ocean from Spitzbergen to Nova Zembla.

Eventually there is a general movement of these accumulated masses of air, or of large portions of them, by which warm, moist, tropical air is transported northward, and cold, dry, polar air southward. As they move they tend to retain their properties, especially in their upper portions. The surface layers are more or less modified by the surfaces over which they move. After the two masses from different sources meet, they largely preserve their identities, instead of mixing freely, and thus are created the “fronts” or “discontinuities” of which we have spoken. As the fronts cross a given place on the earth, there is a more or less abrupt discontinuous change in the properties of the air. Hence, it is along these fronts that the principal changes in weather occur.

Sources of energy.—The weight of air lifted and removed in the development of an ordinary cyclonic depression and the amount accumulated in the formation of an anticyclone are surprisingly great. Numerous calculations have shown that the masses of air moved are of the order of 10 billion to 100 billion tons. Although these amounts

are enormous, they represent only a small percentage of the total mass of air normally overlying the area concerned. Nevertheless, as Shaw remarks, "The creation of a cyclonic depression is an undertaking which altogether transcends the capacity of human agencies."

The energy to accomplish this work is in large part supplied by the energy of motion of the air, constituting the general circulation, to which is added the latent heat released when condensation begins. In the formation and movement of highs and lows we have a transfer of heat by the irregular movement of masses of warm and cold air. There is a never-ending struggle between polar and equatorial air, maintained by temperature differences, and constituting a part of the mechanism of the general circulation. The formation of traveling disturbances is an incidental feature of this struggle.

Tropical Cyclones

A study of weather maps of the West Indies in summer and autumn shows an occasional low-pressure area, differing in a number of ways from the barometric depressions of higher latitudes, and traveling westward instead of eastward. Similar storms occur in low latitudes in other parts of the world, and the general name for them is *tropical cyclone*. Local names are *hurricane* in the West Indies, *typhoon* in the western Pacific area in general, *baguio* in the Philippines, *cyclone* in the Indian Ocean.

Characteristics. A tropical cyclone is a true revolving storm, or vortex, a vast cyclonic whirl with a calm central core, resulting from the rapidity of the whirling motion. There are no observable surface fronts separating masses of warm and cold air; temperature, pressure, winds, and cloudiness are all approximately symmetrical around the center (Fig. 70). Winds are somewhat higher on the right side of a moving storm in the Northern Hemisphere, especially in the right rear quadrant, because there the revolving winds coincide in direction with the direction of the

storm's motion. ⁽¹⁾ They often reach destructive velocities of 90 to 130 miles per hour near the center of the storm. Winds are directed inward, counterclockwise in the Northern Hemisphere, clockwise in the Southern, making an angle of about 30° with the isobars, the incurvature being somewhat greater in the rear of the storm than in the front. Cline ² found that the rainfall is heaviest on the right front of moving West Indian hurricanes and becomes light in the rear half of the storm. When the storm becomes nearly

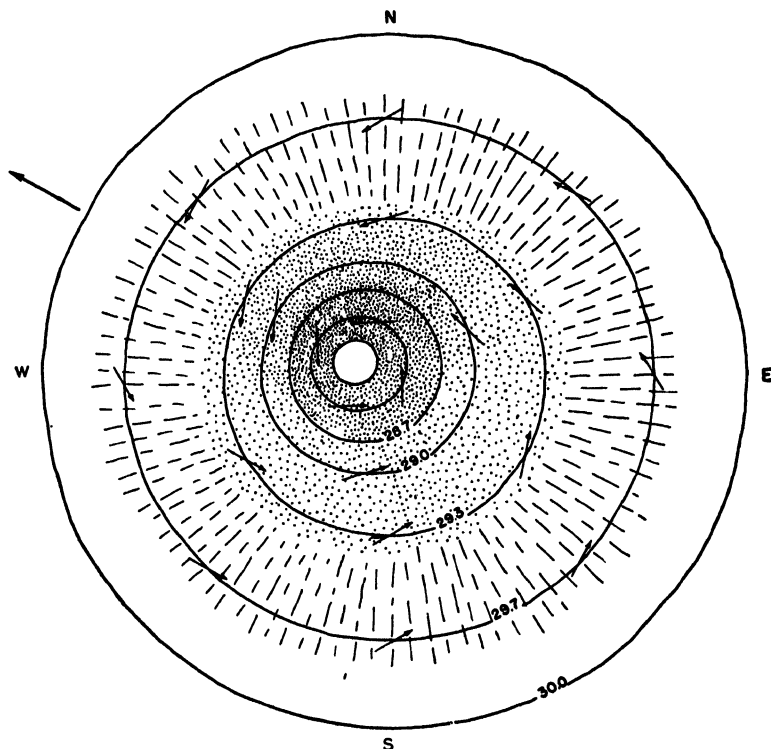

Fig. 70. Diagrammatic Representation of Pressure, Wind, Cloudiness, and Rain in a Tropical Cyclone Moving West-Northwestward in the Northern Hemisphere. Stippled area, rain; broken lines, cloudiness.

² Cline, I. M., *Tropical Cyclones*, pp. 14, 219, 225, The Macmillan Company, New York, 1926.

stationary, the precipitation is more evenly distributed about the center.

In well-developed hurricanes the pressure at the center is below 28.50 inches and often much below. In 1933, four storms with minimum pressure between 27.40 and 27.99 inches, occurred in the region of the West Indies. A tropical cyclone is an area of active penetrative convection, the air moving upward in spirals around the revolving core. Its diameter is usually from 300 to 600 miles. Not much is known relative to the structure of the tropical cyclone aloft, nor the height to which the revolving column extends. There is some evidence that the inflow of air ceases at an elevation of a half mile or less, and above that height the movement of air is outward.

As such a storm approaches, the barometer begins falling, slowly at first and then more and more rapidly, while the wind increases from a gentle breeze to hurricane force, and the clouds thicken from cirrus and cirrostratus to dense cumulonimbus, attended by thunder and lightning and excessive rain. These conditions continue for several hours, spreading destruction in their course. Then suddenly the eye of the storm appears, the wind and rain cease, the sky clears, or partly so, the barometer no longer falls but remains at its lowest. This phase lasts about 30 minutes or longer, and then the storm begins again in all its severity, as before, except that the wind is from the opposite direction and the pressure is rising rapidly. As this continues the wind gradually decreases in violence until the tempest is passed and the tropical oceans resume their normal repose. The violent portion of the storm may last 12 to 24 hours.

The Florida Keys storm of September 1935.—A hurricane of great intensity devastated some of the Florida Keys on the afternoon and night of September 2, 1935. The center passed over Long Key, where a coöperative observer of the Weather Bureau, J. E. Duane, and 19 other persons, were living at a fishing camp. The following are extracts

from Mr. Duane's very graphic and complete description of the storm:

September 2: 2 P.M.—Barometer falling; heavy sea swell and high tide; heavy rain squalls continued; wind from N or NNE, force 6.

3 P.M.—Ocean swells had changed; large waves were now rolling in from SE, somewhat against winds which were still in N or NE.

4 P.M.—Wind still N, force 9; barometer dropping 0.01 inch every five minutes; rain continued.

5 P.M.—Wind N, hurricane force; swells from SE.

6 P.M.—Barometer 28.04, still falling; heavy rains; wind still N, hurricane force and increasing; water rising on N side of island.

6:45 P.M.—Barometer 27.90; wind backing to NW, increasing; heavy timbers flying; beam 6 by 8 inches, 18 feet long, blown through observer's house.

7 P.M.—Now in main lodge building, which was shaking with every blast and being wrecked by flying timbers; water piling up on north side of camp.

9 P.M.—No signs of storm letting up; barometer still falling very fast.

9:20 P.M.—Barometer 27.22; wind abated. During this lull all hands gather in the last cottage. Sky is clear to northward, stars shining brightly and a very light breeze continued; no flat calm. About the middle of the lull, which lasted 55 minutes, the sea began to rise very fast from ocean side of camp. Water lifted the cottage from its foundations and it floated.

10:10 P.M.—Barometer 27.02; wind beginning to blow from SSW.

10:15 P.M.—First blast from SSW, full force. House was now breaking up; wind seemed stronger than any time during storm. Barometer read 26.98 inches. I was blown outside into sea; got hung up in broken fronds of coconut tree and hung on for dear life; was then struck by some object and knocked unconscious.

September 3: 2:25 A.M.—Became conscious in tree and found I was lodged about 20 feet above the ground. The cottage had been blown back on the island, from whence the sea had receded and left it with all people safe.

Hurricane winds continued till 5 A.M. and terrific lightning flashes were seen. After 5 A.M. strong gales continued throughout the day with very heavy rain.

It is estimated that in this storm wind velocities were 150 to 200 miles per hour. Destruction was practically complete over a path 30 miles wide, extending considerably farther to the right than to the left of the path of the center. The destructive storm tide had the same direction of advance as the storm center, flowing from southeast to northwest. The rate of advance of the storm was about 10 miles per hour, and the calm center was perhaps 8 miles in diameter.³

³ McDonald, W. F., "The Hurricane of August 31 to September 6, 1935," *Monthly Weather Review*, Vol. 63 (1935), pp. 269-271.

Lowest observed pressures.

In the Florida Keys storm just described, an aneroid barometer in a boat tied up near the north end of Long Key indicated a barometric pressure of 26.35 inches at the center of the storm. This pressure was arrived at after careful tests of the aneroid with standard mercurial instruments under reduced pressure in the laboratory. It is the lowest sea level pressure ever observed in the Western Hemisphere. The lowest previous record was 27.01 inches in the Caribbean hurricane of November 5, 1932, and the previous record in the United States was 27.45 inches, September 16, 1928, at West Palm Beach, Florida. Only one reading lower than 26.35 inches has been reported at sea level anywhere in the world. This was a pressure of 26.185 inches, observed in a typhoon about 460 miles east of Luzon on August 18, 1927.⁴

Regions and times of occurrence.—Tropical cyclones begin over the oceans in the doldrums when these are some distance from the equator. They are more frequent on the western sides of the ocean, but some originate toward the eastern boundaries, as, for example, near the Cape Verde Islands in the north Atlantic and off the coast of Mexico in the Pacific. The six general regions of the world where most tropical cyclones occur are: (1) from the Bahamas to the Caribbean Sea and the Gulf of Mexico; (2) in the Pacific Ocean west of Mexico; (3) in the neighborhood of the Philippines and the China Sea; (4) in the Bay of Bengal and, less frequently, the Arabian Sea; (5) in the southern Indian Ocean east of Madagascar; (6) in the south Pacific from the vicinity of Samoa and the Fiji Islands westward to the north and west coasts of Australia. Some tropical cyclones occur outside of these regions. None are known to occur in the south Atlantic Ocean. The regions of frequent occurrence and the normal paths are shown in Fig. 71.

These disturbances occur only in summer and autumn, in contrast to the depressions occurring within the prevailing westerlies. The latter are present at all seasons of the year but are most active in winter. In the Northern Hemisphere tropical cyclones occur from June to November, but

⁴ McDonald, W. F., "Lowest barometer reading in the Florida Keys storm of September 2, 1935," *Monthly Weather Review*, Vol. 63 (1935), p. 295.

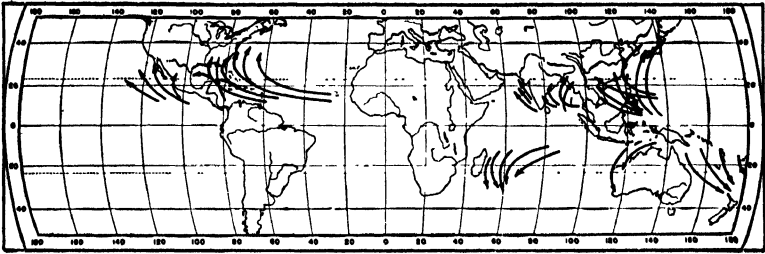

Fig. 71. Regions and Generalized Paths of Tropical Cyclones. Individual paths are extremely variable, and occasional storms of this type develop or travel far outside of these areas.

the months of greatest frequency are September and October, except in the vicinity of India, where they occur in the calm seasons between the monsoons, that is, from April to June, and again in October and November. In the Southern Hemisphere the time of occurrence is from January to April. The average number in the north Atlantic is about six per year.

Origin and path.—Hurricanes originate in the calm, moist, warm air of the doldrums in regions far enough away from the equator for the deflective force of the earth's rotation to initiate the curving motion, not less than 5° from the equator and most frequently between latitudes 10° and 20° . The doldrum belt does not migrate much south of the equator in the Atlantic Ocean; hence the absence of these storms in the south Atlantic. Evidently they begin under conditions favoring convection except that surface temperature differences over the warm ocean water are small. There is some evidence of frontal activity aloft. In the western Pacific, typhoons appear to result from the meeting of trade-wind air of the Northern Hemisphere with the equatorial air of the southwest monsoons. The latter winds are warmer and moister aloft than the trade winds, and the meeting of the two air masses results in instability. In the Atlantic Ocean, the inception of a hurricane is probably due at times to a convergence of air masses of somewhat different densities from the Northern and Southern

Hemispheres. In both oceans it is probable that the initial impulse is frequently given by the invasion aloft of cold, dry air from higher latitudes. In all cases after the active upward movement has begun, the copious condensation supplies the energy to develop the storm into true hurricane violence.

Late summer and autumn is the time of most frequent hurricane occurrence, because it is then that the ocean waters are warmest and the doldrums farthest from the equator. Quiet atmospheric conditions are essential as is shown by the occurrence of hurricanes in the northern Indian Ocean only in the seasons between the monsoons. A tropical cyclone moving over land soon becomes larger and weaker and ceases to be of destructive energy, evidently because of the diminished supply of warm, moisture-laden air. All these facts of observation point to the conclusion that tropical cyclones are of convective origin.

Tropical cyclones, once started, move westward in the prevailing westward drift of the air in the doldrums and the trade-wind belts, curve gradually to the right in the Northern Hemisphere and to the left in the Southern, and travel at the moderate velocity of 10 to 30 miles per hour. Occasionally, they remain nearly stationary for a time, or veer from their normal course. Finally, if they persist long enough, they move into the prevailing westerlies, often curving around the western sides of the summer oceanic highs, and then travel eastward as do ordinary extratropical lows. The typical path is a parabola, but the actual path of any given storm is governed by the general field of pressure in which it is moving, that is, by the general distribution of pressure around it.

Effects of tropical cyclones.—Tropical cyclones are destructive in their violence and are avoided by ships at sea if possible. The islands of the West Indies have been struck by hurricanes at various times, and paths of differing widths up to a few hundred miles have been laid waste, often with great loss of life. Storms of equal violence,

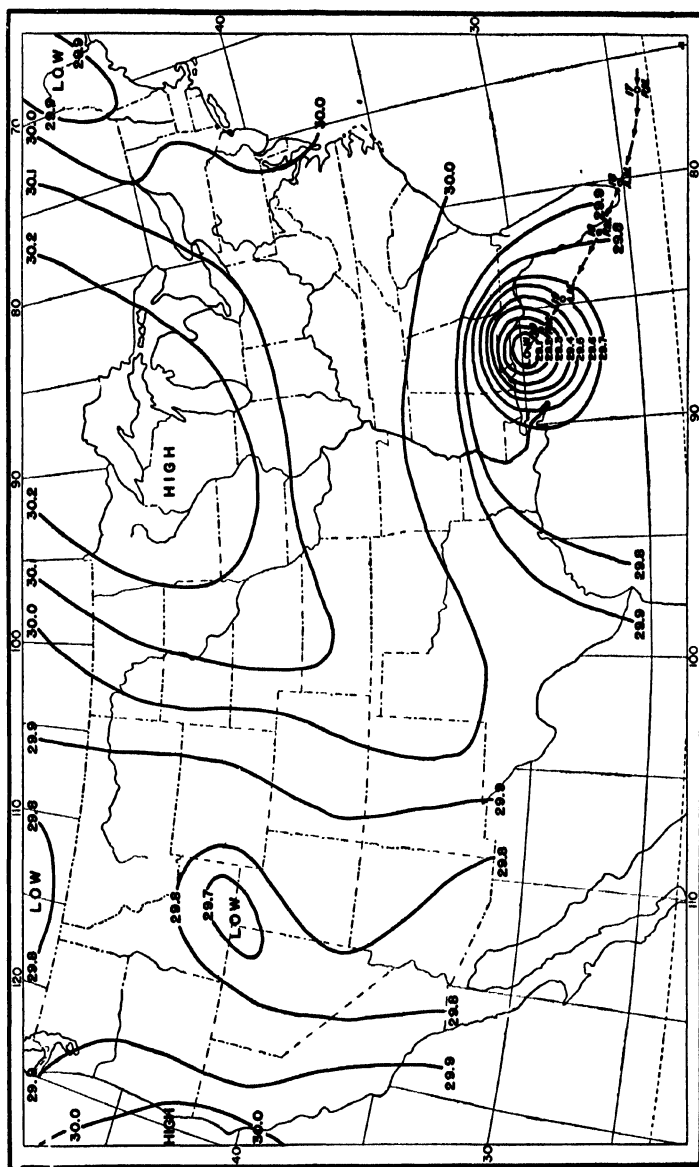

Fig. 72. Tropical Hurricane of September 20, 1926; Pressure Distribution at 8 A.M., 75th Meridian Time, from U. S. Weather Map. Pressure at Pensacola, 29.10 inches; wind velocity, 100 miles per hour. Line of arrows shows previous path of the hurricane, and small circles show position of center at 12-hour intervals. Two days later the storm was dissipated in Louisiana.

killing large numbers of people, have also occurred in China, the Philippines, and Samoa. Occasionally storms of destructive severity reach Florida and the Gulf coast of the United States. There was such a storm at Galveston, Texas, in September, 1900, with a loss of 6,000 lives, and in Florida in September, 1928, resulting in about 2,000 deaths. In the Florida storm a large part of the loss of life and property was caused by the overflowing of Lake Okeechobee; strong north winds, estimated at 150 miles per hour, raised the water level on the south shore by 10 to 15 feet and drowned many people. At Galveston, also, the loss of life was largely owing to flooding of the low land on which the city is built. (The city is now protected by a sea wall.)

The violence of these storms creates great ocean swells, which out-travel the storm and precede it by some distance. Along the Gulf coast the water begins to rise when the hurricane is 300 to 500 miles distant, that is, one or two days before the storm arrives, and often rises 8 to 15 feet above the normal level of the Gulf. Changes in the place of greatest rise of water indicate changes in the course of the storm. Observations of the direction and character of these waves as they reach the coast, and of the amount of the rise at different places, afford a basis of forecasting the time and point at which the hurricane will arrive. By means of ship and land reports the U. S. Weather Bureau follows as closely as possible the development and path of each West Indian hurricane and forecasts its future movement and severity. Thus the Weather Bureau is the means of saving many lives and much property, particularly by keeping ships in harbor or enabling them to avoid the paths of the storms. Fortunately such storms are not very numerous nor very wide and never extend with destructive force far inland.

Summary

A weather map is a map of a large area showing the weather conditions existing at a given time. The distribu-

tion of pressure and temperature over the area is shown by isobars and isotherms. The use of the weather map during the past 100 years has been the principal means by which the science of meteorology and in particular the practice of weather forecasting have been developed.

The barometric depression, or cyclone, is a prominent feature of weather maps, outside the tropics. These areas of low pressure have winds directed somewhat inward across the isobars and counterclockwise in the Northern Hemisphere. They originate in irregularities of flow along the surfaces of discontinuity, where air streams or air masses of differing temperature and humidity come in contact. In particular they originate along the polar front, where polar easterly winds meet warm westerly winds. They consist of a warm sector, that is, a body of warm air, in their southern and southeastern portions, more or less nearly surrounded by colder air masses on the east, north, and west.

The eastward-moving warm air forms a warm front where it meets and overrides colder air. On the west the advancing cold air forms a cold front, forcing the warm air to ascend. Hence, cloudiness and precipitation usually attend both the warm and cold fronts. The depression becomes occluded when the cold front overtakes the warm front and the two are united near the center of the cyclone into a single occlusion front.

Areas of high pressure, or anticyclones, with winds which flow out spirally in a clockwise direction, in the Northern Hemisphere, are also of frequent occurrence. In the central portion of these areas, winds are usually light and skies clear. Highs are sometimes formed as are the lows, by irregularities along the polar front, and sometimes are simply equatorward surges of cold, dense air.

In middle latitudes the air masses usually drift eastward in the prevailing westerlies, carrying with them the warm and cold fronts and the associated moving depressions and anticyclones, with their characteristic weather. Large anti-

cyclones, however, often show considerable tendency to stagnate. Depressions affecting the United States originate in the eastern portion of the Pacific Ocean, especially in the vicinity of the Aleutian low, or in the western portions of the United States and Canada, and move eastward, often curving southeastward in the Mississippi Valley and then northeastward toward the north Atlantic coast. A few develop in the east Gulf and south Atlantic regions. Anticyclones may enter also from the Pacific but often appear first in western Canada or in the region of Hudson Bay. The movement of air masses results in the formation of traveling highs and lows, and in the frequent changes in weather in temperate latitudes.

Tropical cyclones, also known as hurricanes and typhoons, are revolving storms, 300 to 600 miles across, with pressure, temperature, wind velocity, and condensation more or less symmetrically distributed around the center. They are of convective origin, with air revolving rapidly and ascending in spirals, resulting in very low pressures at the center and in winds of destructive violence. They originate over the oceans in the doldrums, 10° to 20° from the equator, in summer and autumn, and move slowly westward, gradually curving away from the equator. The warm, saturated air of tropical oceans, and overlying cool air are necessary to initiate such violent storms and to maintain them at hurricane intensity. They decrease to moderate storms when they move over large land areas and when they curve into higher latitudes over the oceans.

Problems

1. From a series of weather maps:
 - a. Determine the size of the highs and lows within the closed isobars, noting the length and direction of the longest and shortest diameters.
 - b. Determine the direction and velocity of motion of the individual highs and lows.
 - c. Determine the distribution of temperature about the

centers. Where is it highest? Where lowest? Are there sharp discontinuities of temperature?

d. Determine the distribution of cloudiness.

e. Where, with reference to the centers of the depressions, is rain falling at the time of observation? Where has it fallen during the past 24 hours?

f. Determine the direction and velocity of the winds in the different quarters of the lows and highs and note their relation to the pressure gradient. Locate any definite wind-shift lines.

g. Locate cold and warm fronts by a consideration of wind directions, temperature differences, clouds, and rain.

h. Identify the depressions as young or as occluded lows.

2. If a series of Washington weather maps showing West Indian hurricanes is available, make a similar study of these storms.

3. Draw weather maps from data given, and locate fronts if possible.

CHAPTER IX

Lesser Disturbances

There are two minor air disturbances, which, though smaller and of less general significance than cyclones and anticyclones, are attended by characteristic and striking phenomena and are important features of the weather wherever they are prevalent. These are the thunderstorm and the tornado. In addition, certain winds which are not independent disturbances but are parts of larger air movements acquire distinguishing properties in some regions and at some times and have received special names. Those to be discussed briefly in this chapter are the foehn, or chinook, sirocco, cold wave, blizzard, and dust storm. Special characteristics are acquired by these winds because of geographic situation, local topography, or conditions of the earth's surface.

Thunderstorms

Broadly speaking, a thunderstorm is any storm in which thunder is heard, and this is the definition used by the Weather Bureau in recording the occurrence of thunderstorms. Thunder often occurs in tropical cyclones, general cyclonic storms, and tornadoes, but a typical thunderstorm, as distinguished from these storms in which thunder is incidental, is a local storm of short duration and of convective origin, proceeding from a large, anvil-shaped cumulonimbus cloud, often attended by heavy rain for short periods, and sometimes by hail.

Description of a local thunderstorm.—On a quiet summer afternoon with gentle southern winds a cumulonimbus cloud sometimes approaches from the west or southwest,

drifting east or northeast with the wind aloft while the surface air is moving slowly toward the cloud. The black, suspicious, threatening cloud draws near, and "heavens' artillery thunders in the skies," and soon the heavy rain begins. About the time the first rain reaches the earth, there is a sudden strong and chilly gust of wind directly from the storm, and after this the wind decreases slowly. The rain comes down "by pailfuls" for a time, and then it also gradually diminishes, and in an hour or two the storm has passed, the sky is clear, and gentle winds again blow from the south. Such a storm is normally only a few miles wide, sometimes spreading to 30 or 40 miles if it continues over a path 100 or more miles in length, as occasionally happens. The edges of the storm are well marked; the rainfall may be heavy within the path and fall off to nothing within a few hundred feet.

Violent movements in a thunderstorm.—If one watches for a time the growth of cumulus clouds with their flat bases and irregular, towering summits, one sees evidence of much turbulence and active vertical motion, and such movements have often been encountered by aviators. The formation of hail is also evidence of violent movements. Hail occurs only in the front part of the storm, just at the rear of that portion where the upward velocity is very great. (See Fig. 73.) The *squall cloud*, indicated at *S* in

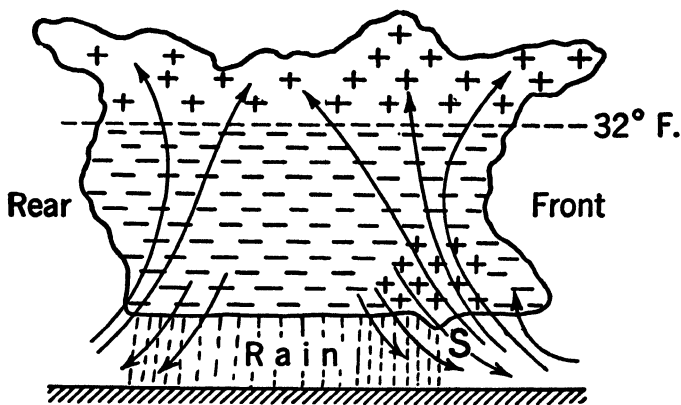

Fig. 73. Cross Section of Typical Local Thunderstorm.

the figure, is a horizontally turning vortex between the rising warm air near the front of the cloud and the descending cold air where rain is falling. The cool, descending air forms the gust or squall wind which occurs with the breaking of the storm, and produces a sharp rise in pressure of a few hundredths of an inch, always visible on the barograph trace, and familiarly known as a "thunderstorm nose." (Fig. 74.) The descending air is cooled in part by

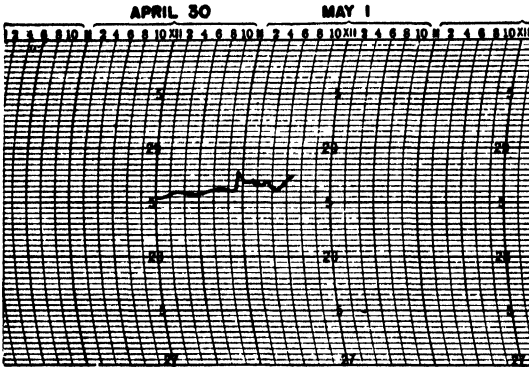

Fig. 74. Barograph Record During Thunderstorm. Rain began at 10:15 P.M., April 30th; ended, 3:40 A.M., May 1st. First thunder heard at 10:20 P.M.; last at 11:15 P.M., April 30th.

contact with the raindrops, which are not dynamically warmed by descent, but in greater degree by evaporation of the falling drops after they leave the cloud. By this latter process rain tends to cool the air to its wet-bulb temperature.

Conditions requisite to the development of a thunderstorm.—To produce the strong convectional activity necessary to the development of a thunderstorm, both an adequate supply of moisture and a large lapse rate are necessary. The lapse rate must be in excess of the dry adiabatic from the surface to the height where condensation begins, and greater than the wet adiabatic for a considerable distance above the bases of the clouds. In order that the clouds may grow to sufficient size to produce a

thunderstorm, the air must continue to rise through a distance of 1 to 4 miles, as observations of the tops of cumulus clouds show.

How the necessary instability is produced.—There are two distinct ways by which this instability may be brought about. First, *heating of surface air*, such as occurs over land areas in summer, may create a large temperature difference between the lower air and the air above it. This gives rise to the typical thunderstorm described above, and often called a *heat thunderstorm*. Such storms occur most frequently over land and on summer afternoons when the humidity is high. Although the air is cooled during the time of cloudiness and rainfall, it again becomes hot and oppressive after the storm has passed, for such storms occur within warm air masses. What may be called artificial heat thunderstorms sometimes occur over forest fires and active volcanoes, but only if the lapse rate above them is favorable.

Second, the presence of abnormally *cold air aloft* may produce the necessary steep temperature gradient and instability. Such thunderstorms occur especially in the southern quadrants of depressions, where there are converging warm surface currents from the south or southeast and much colder upper currents from the southwest or west. They may occur by night and in winter, but over continental areas they are more frequent in summer and by day, when local surface heating helps to create the necessary temperature contrast, and when also, absolute humidity is greater.

Over the oceans, thunderstorms occur mostly in winter and in the latter half of the night. There is little heating of the ocean surface by day, not enough to produce strong convection currents. At night the ocean surface and the moist lower air cool slowly, while the upper air cools more rapidly by radiation. The difference in temperature becomes greater as the night progresses, and hence the gradients necessary for convection are most frequent late at

night. Similarly, in winter the lower air over the oceans is relatively warm, because the water cools slowly, while the upper air is cold. Records show that in Iceland, where the earth's surface is not warmed in summer, thunderstorms also occur mostly at night and in winter. In the British Isles, winter thunderstorms sometimes occur in cold polar air currents, the lower portions of which have been warmed in moving southward, especially when they have passed over warm ocean waters. These also are instances of thunderstorms due to abnormally cold air aloft rather than to abnormally warm surface air.

The forcing of warm, moist air upward by its movement up slope or by the underrunning of cold air often furnishes the initial impulse in the formation of thunderstorms, when the lapse rate aloft is sufficient to continue active convection. Thunderstorms due to underrunning cold air occur along the cold front of a depression, sometimes in connection with general rains attending the passage of the cold front. Under such conditions many thunderstorms may develop at about the same time, moving in parallel lines along a considerable length of the front. These are known as *line squalls*, and are of frequent occurrence in the United States. They may occur at any time of day and any season of the year but are rare in winter. Such thunderstorms are followed by lower temperatures, because of the advancing cool air which causes them. When these thunderstorms follow a hot spell in summer, the newspaper headlines often say, "Showers bring cooler weather," when the correct heading would be, "Cooler air brings showers." Another form of this popular error is the assumption that hail has caused the cooler weather. The cooling due to hail is slight, temporary, and local. The change to cooler weather is due to the arrival of a cool air mass.

Geographic distribution.—Thunderstorms are most frequent in the rainy regions of the tropics where heat and moisture are abundant and where, also, light winds favor convection. At some places within the tropics, as in

Panama, Java, and equatorial Africa, the average number of days with thunderstorms is as great as 200 per year. They are very rare in polar regions and in cold areas generally. In the United States they are most frequent along the eastern Gulf coast, where they occur on more than 70 days per year, mostly from June to September, inclusive, reaching an average of 94 a year at Tampa, Florida. There is a secondary maximum for the United States in the southern Rocky Mountain region, Santa Fe, New Mexico, averaging 73 thunderstorm days per year. Here orographic influences are the most important factor, since mountain sides facing the wind force air upward, and mountain sides facing the sun are great aids to convection. The region of minimum frequency in the United States is in the Pacific coast states, where thunderstorms average from 1 to 4 a year, not including the mountain regions. It has been estimated that over the earth as a whole an average of 44,000 thunderstorms occurs each day, and an average of 1,800 is in progress at all times. Because of their small size and local character, it is not possible to foresee the precise time and place of occurrence of thunderstorms. The hour of fall and area covered seem to be matters of chance, especially for those storms in which local heating plays a large part. Thunderstorms occurring along a cold front can be placed more accurately, if the front is followed closely.

While thunderstorms over land areas are more likely to occur during the day than at night, because of the heating of the air by day, a large part of the United States receives more than half its precipitation at night during the warm season, April to September, inclusive.¹ This is the region of the Great Plains, the Missouri Valley, and the upper Mississippi Valley. In this area of generally light rainfall the occurrence of most of the precipitation at night is of some economic value in conserving the moisture. It is of con-

¹ Kincer, J. B., "Daytime and nighttime precipitation and their economic significance," *Monthly Weather Review*, Vol. 44 (1916), pp. 628-633.

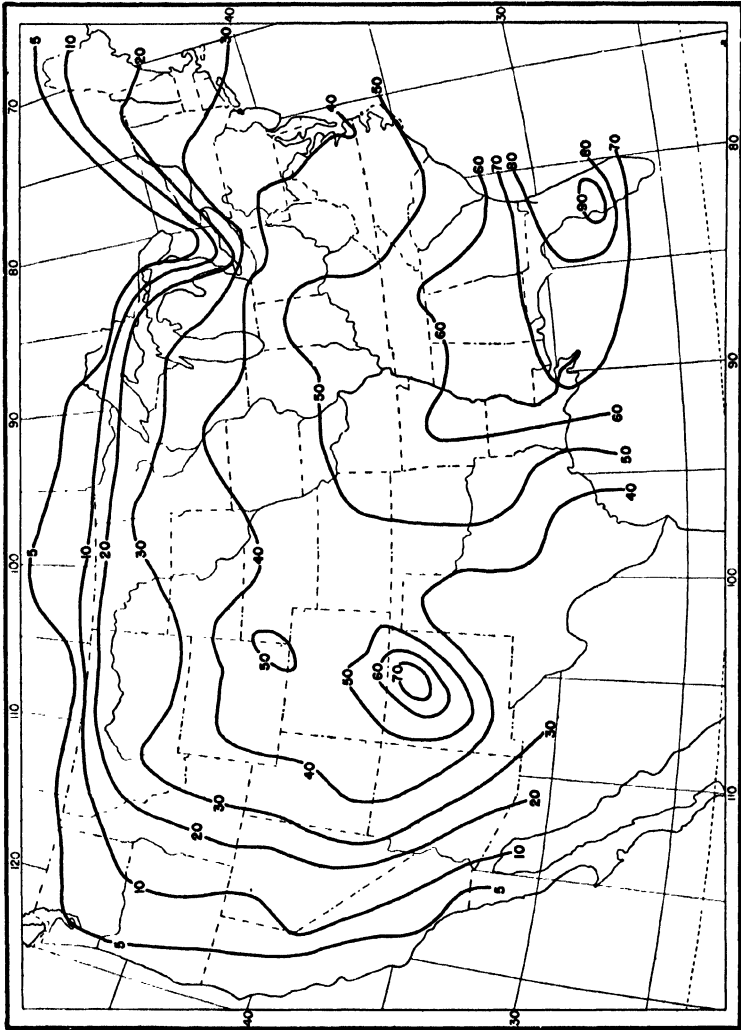

Fig. 75. Average Annual Number of Days with Thunderstorms in the United States. (After W. H. Alexander.)

siderable value in harvesting and threshing small grains and curing hay, because it permits drying by day.

In this region of rather low average humidity, heating of the surface air is often not sufficient of itself to cause thunderstorms, but such storms are frequent when the lapse rate is increased by an inflow of cold air aloft. Why this inflow occurs more often at night is explained by Humphreys² about as follows: Most of the summer thunderstorms of this region occur when there is a cool anticyclone along the northern border of the country between Montana and the Great Lakes, and when there is either low pressure in the southwest or a trough of low pressure across the central portion of the country from north to south, or from northeast to southwest. Under such conditions the Great Plains and the Missouri and Upper Mississippi valleys often become very warm by day. Hence, the lower air expands, and the pressure at an elevation of a half mile and higher is increased until it may be approximately equal to that over the cold anticyclone to the north, at corresponding elevations. This prevents the inflow by day of much cold air at these heights. At night the warmer region normally loses heat more rapidly than the cooler; the pressure at any considerable elevation, accordingly, tends to fall more over the warm region than over the cold, and this allows the cooler air to flow southward over the warm lower air. This establishes that convectional instability essential to the genesis of the thunderstorm.

Origin of electric charge.—Laboratory experiments have shown that when drops of water are broken into smaller drops or spray by a current of air, the droplets gain a small positive charge of electricity, and the air around them an equal negative charge. This occurs at each successive division of the drops, and appears to explain the positive charge in the lower front portion of the cloud, where rain is fall-

² Humphreys, W. J., "On the difference between summer daytime and nighttime precipitation in the United States," *Monthly Weather Review*, Vol. 49 (1921), pp. 350-351.

ing heavily through a rapid updraft of air. Thus, a large potential difference is created between the lower portion of the cloud and the earth. In the upper portion of the cloud, it is probably the friction of snow crystals against each other that produces the electrification. The crystals become negatively charged and remain in the middle of the cloud or fall toward the base. The air becomes positively charged, and as it ascends it carries the positive electricity to the top of the cloud.

This explanation is in essential agreement with the many observations of potential gradient that have been made in recent years. The distribution of electricity in a thunderstorm cloud therefore appears to be as indicated in Fig. 73. The lower, anterior portion, where heavy rain is falling, is positively charged. The interior portion and the lower rear and extreme front are negative, and the top of the cloud is positive. Probably the best confirmed observation supporting this picture is that the drops in the heavy shower at the beginning of a thunderstorm usually carry a positive charge, and the steadier rain in the rear portion usually has a negative charge. Other forms of cloud do not become thus highly charged, because of the absence of the rapid uprush characteristic of cumulonimbus.

Nature of lightning.—Lightning is the flash of light caused by a discharge of atmospheric electricity. The discharge may be (1) between two parts of the same cloud, (2) from one cloud to another, or (3) between a cloud and the earth. Thunder is the sound of the discharge, due to the sudden expansion of the air by heating. Air offers a high resistance to an electric current, and the passage of the current through it produces a rapid heating. Lightning is a direct, not alternating, discharge and its duration is from .0002 second up to perhaps 1 second in a multiple discharge (successive flashes along the same path). The current varies from a few thousand to 100,000 amperes, and the potential difference is of the order of 100,000,000 volts.

The common names, "forked," "zigzag," or "streak"

lightning are used when the path of the discharge is visible, whether between cloud and earth or from one cloud to another. The path of a discharge is never really zigzag but is often variously curved, and frequently branching.



Fig. 76. Direct, Branching Lightning Discharges. *Photo by J. C. Jensen.*

“Sheet” lightning is the sudden lighting up of cloud and sky by a discharge, the path of which is not seen. In this case the storm is usually distant, as indicated in Kipling’s description, “Sheet lightning was dancing on the horizon to a broken tune played by far-off thunder.” Often the thunder is not audible. A rare and curious form of lightning, not fully explained, is known as ball lightning and consists of luminous balls or masses, usually moving at moderate speed, and lasting a few seconds. The disturbing effects in radio receiving apparatus, known as atmospherics or static, originate largely in lightning strokes, and thus the positions of large, distant thunderstorms can be determined by the use of two or more radio direction recorders (oscillographs) placed at known distances from each other.



Fig. 77. Ball Lightning. Three stages; about $2\frac{1}{2}$ minutes elapsed between the first and last stages. *Photo by J. C. Jensen.*

Protection against lightning.—Lightning rods, if properly installed, carry the electric current to the earth and afford good protection to a building and its occupants. Proper installation requires that the conductors be of sufficient size, extend to every high point of the building, be cross-connected into one system with good joints and no sharp angles, and be well grounded at several places. Steel buildings are safe places to be during a thunderstorm, and any house is safer than out of doors. Low places are safer than hills. Wire fences and trees standing alone are especially to be avoided.

Tornadoes

A small storm which is rare in its occurrence at any one place but which is much feared because of its destructive violence is the tornado, meaning, in its derivation, a turning or whirling wind, and often colloquially called a "twister."

Tornado characteristics.—Tornadoes are revolving

storms, turning counterclockwise in the Northern Hemisphere. They are of great intensity but small diameter and have rapidly rising air at the center. They are barometric depressions resembling tropical cyclones but very much smaller, of much shorter life, and with much steeper pressure gradients. A funnel-shaped cloud develops in a low, heavy, cumulonimbus cloud mass and extends toward the earth. The funnel rises and falls, turns and swings in various directions. Where it reaches the earth, there is complete destruction attended by a deafening roar and by semi-darkness; where it fails to reach the earth, there is little damage. It is estimated that winds near the center attain velocities of 200 to 300 miles per hour, and the updraft at the center reaches 100 to 200 miles per hour. A typical violent thunderstorm develops with the tornado, giving heavy rain and often hail.

The pendent cloud is a real cloud of water droplets, condensation being due to dynamic cooling by expansion because of the reduced pressure, but where the cloud reaches the ground, it picks up much dust and debris and becomes in part a dust cloud. The diameter of the destructive portion is generally less than a quarter of a mile; its rate of advance is 20 to 40 miles per hour. Hence, at any one place the tornado is all over in about half a minute. The direction of movement in the United States is nearly always from southwest to northeast. If a tornado is seen approaching, one can escape its violence, if an automobile is at hand, by driving at right angles to its path. In most cases driving southeast is the safest. The safest place, when within reach, is the "cyclone cellar," which should be a solidly-built room completely underground and away from any building.

Destructive forces in a tornado.—There are three damaging forces active in a tornado. First, the "hideous tempest" wrecks buildings and shakes down trees, the trees falling in the direction of the whirl. Second, there is an explosive effect within buildings because of the sudden

TORNADO AT GOTHENBURG, NEBRASKA, JUNE 24, 1930;

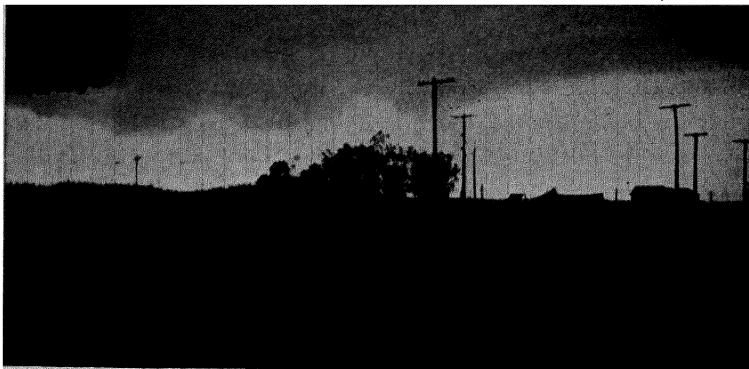

Fig. 78a. Heavy, Dark Cloud with Ragged, Irregular Undersurface.



Fig. 78b. Tornado Funnel Beginning at the Cloud Level.



Fig. 78c. The Funnel has Nearly Reached the Ground.

ITS DEVELOPMENT, APPROACH, AND AFTERMATH.

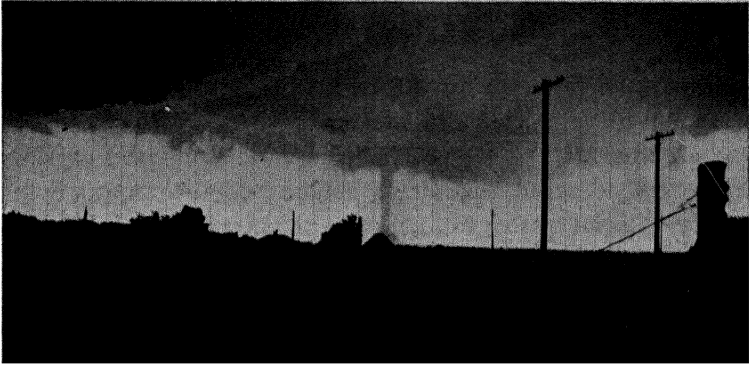

Fig. 78d. The Funnel Cloud has Now Reached the Ground and is Picking Up Dust and Debris.



Fig. 78e. The Tornado Approaches the Observer, Continuing in Contact with the Ground.



Fig. 78f. What Remains of Several Farm Buildings and Automobiles after the Tornado has Passed. *Photos by Otto Wiederanders.*

reduction of pressure on the outside. The walls fall outward in all directions. Third, the lifting effect of the violent updraft raises even very heavy objects and carries them considerable distances, sometimes dropping them gently without damage.

Place and time of occurrence.—Tornadoes occur along an abrupt cold front of a well-developed depression, especially a V-shaped depression, where winds of quite different temperatures meet. The surface wind in this section of a depression is usually from the southwest, and that is why most tornadoes move from that direction. Several tornadoes often occur on the same day in connection with the same cold front and move in nearly parallel lines, in this respect resembling squall-line thunderstorms. They are most frequent in the afternoon in spring and early summer, but they occur throughout the summer and fall. The Mississippi, Ohio, and lower Missouri Valleys are the regions of greatest frequency. The states in which the greatest numbers occur are, in order of frequency, based on 52 years of record: Kansas, Iowa, Texas, Arkansas, Illinois, and Missouri. Tornadoes are frequent also in Oklahoma, Nebraska, Mississippi, Alabama, Ohio, Indiana, Georgia, Minnesota, Wisconsin, and southern Michigan. They are rare but not unknown in other parts of the United States and other parts of the world. The number reported in the United States averages about 75 a year.

Because of the small size and usually short path of a tornado, the chances of a given building being wrecked by one are extremely small even in areas where these storms are most numerous. The annual number of deaths due to tornadoes is small compared to those due to automobile accidents. Within the states mentioned above, after portions of some of them where tornadoes have never occurred have been deducted, there is an average of one tornado per year in about 17,000 square miles of area. Owing to their very local character and the apparently fortuitous circumstances

under which tornadoes occur, the Weather Bureau has not found it practicable to forecast their occurrence.

Cause of tornadoes.—The cause of tornadoes is violent convection, aided by opposing winds of very different densities, due for the most part to greatly different temperatures along a cold front or an upper cold front. Tornadoes begin at the cloud level with a whirling motion around a vertical axis. The whirl is started by upward motion and, once started, contributes to the increase of the updraft. These storms are most frequent in the central United States because, in that region, cold Canadian air, moving southward in close proximity to warm, moist air, moving northward from the Gulf of Mexico, creates greater temperature contrasts between adjacent currents of air than are often found elsewhere in the world. The contrasts are greatest in the spring months, when north winds are still wintry.

Waterspouts.—Where tornadoes occur at sea, they are known as waterspouts. The funnel cloud is formed in the same way, by adiabatic cooling under reduced pressure, and when it reaches the water surface, it picks up spray. Such waterspouts are known to occur off the east coast of the United States, in the Gulf of Mexico, and off the coasts of China and Japan, in regions where cold, continental air extends over warm water. They have a cyclonic circulation like that of tornadoes. Another type of storm that is also called a waterspout begins in fair weather instead of with a thunderstorm and is observed mostly in tropical waters. Such storms begin at the ground and grow upward, are small in diameter, not much affected by the earth's deflective force, and may turn in either direction. There can hardly be strong enough contrasts of temperature in tropical waters to start these whirls, but it is thought that strong convection begins at the ground because the surface layer of air in contact with warm water becomes very moist and hence lighter than the drier air above it. This is an ex-

ample of convective rising caused more by humidity differences than by temperature differences.

Whirlwinds.—Whirlwinds, or dust whirls, occur over land on hot days when the surface air becomes much warmer than that a few hundred feet above it, thus starting these small, shallow whirls of upflowing and inflowing air. By mixing the air to an increased depth, they prevent the surface air from getting as hot as it otherwise would. Unlike tornadoes, the whirls begin at the ground and may turn in either direction. They are common in many parts of the world, but especially in desert and semi-arid regions, where they are sometimes of force enough to do some damage.

Some Special Winds

Many local popular names, in various parts of the world, have been given to winds coming from certain directions or having some easily recognizable characteristic. Often these winds have no general meteorological interest, but a few of them have special properties worth noting.

Foehn or chinook.—A foehn is a warm, dry wind of moderate to strong velocity, coming down a mountain slope. The movement is the result of pressure differences on opposite sides of the mountain chain. On the windward side pressure is relatively high, and air is forced to rise over the mountain, with consequent expansion and cooling at the dry adiabatic rate at first, followed by condensation and retarded cooling. On the leeward side there is descent of air, compression, and adiabatic warming for the entire distance. Therefore, when the air reaches the same elevation at which it started on the other side, it has by the act of moving over the mountain become both warmer and drier. Winds of this kind are especially common on the northern side of the Alps in Switzerland, where they are called foehn winds, and on the eastern slope of the Rocky Mountains in Wyoming and Montana, where they are called chinooks. There is frequently a very marked contrast between the air in these winds and the surrounding air, especially in winter, and the

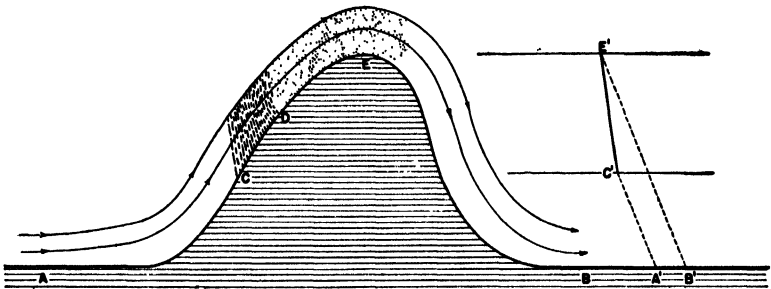

Fig. 79. Diagram of Föhn Wind and Resulting Changes in Air Condition. Condensation begins at *C*; precipitation at *D*. The air is both warmer and drier at *B* than at *A*. Temperature, potential temperature, relative humidity, absolute humidity, and specific humidity have all been altered by the movement of the air from *A* to *B*. Wet-bulb temperature is unchanged.

chinooks are capable of causing the rapid disappearance, by melting and evaporation, of a considerable snow cover.

Sirocco.—Warm cyclonic winds have received local names in many parts of the world. Sirocco originally meant a south wind coming from the Sahara Desert and reaching northern Africa hot, dry, and dusty. Sometimes the sirocco extends to the northern shore of the Mediterranean where it becomes a warm and moist wind. The name is sometimes applied more generally to any hot wind occurring in the warm sector of a passing depression and heated by moving over hot and dry land areas. Such are the so-called "hot winds" of the Great Plains in the United States.

Cold wave.—A cold wave is a sudden change from warm to much colder weather, occurring in winter in interior and eastern North America, along the cold front of an advancing high, following an active low. As the great drop in temperature advances rapidly eastward and southward, its movement suggests an oncoming flood or a large ocean wave. Before the Weather Bureau began issuing warnings of the approach of these waves, people were unprepared for the sudden changes. The Weather Bureau's definition of a cold wave varies with the season and the locality. There must be a 24-hour fall in temperature of 16° to 20° , or more; the minimum temperature that must be reached varies from

zero in the northern states in winter, to 32° in the extreme southeastern states.

Blizzard.—Blizzard is a term originating in America and applies to a storm with high northerly winds, driving snow, and low temperature, generally occurring under the same conditions as, and often attended by, a cold wave. It has come to be applied to similar storms in other parts of the world, especially in the Antarctic region where winds laden with hard snow often blow with velocities of 75 to 100 miles per hour. It is not officially used by the Weather Bureau and has no exact meaning in terms of temperature or wind velocity.

Dust storms and dust falls.—Moderate to strong winds blowing over a soil that is dry, loose, and composed of fine particles often raise clouds of dust which are carried along in the lower air by the wind. These are frequent in the southern Great Plains but are usually local in their incidence. However, when great areas become very dry, as happened in the summer of 1934 from North Dakota to Texas, the entire lower air over large districts may be filled with dust. When the air has a stable lapse rate, the dust remains near the ground, and clear sky can be seen overhead. When the air mass is unstable, turbulence and convection lift the dust to greater heights, and a thick layer of the lower air becomes dust-laden so that the sky is overcast with a gray dust cloud, and the sun becomes a pale disk or is completely hidden. Sometimes in the Great Plains region the cloud is so dense and dark in limited areas as to require artificial lighting at midday. Along a distinct front having a sharp increase in wind velocity, the cloud of dust may advance like a moving wall, and the very minute of its arrival at a given place may be observed. At other times the dust diffuses and thickens slowly and imperceptibly.

Dust which is thus lifted into the air is composed of very fine particles which may be carried great distances, usually moving eastward before settling to the earth. Thus in the



Fig. 80. Dust Storm, Johnson, Kansas, April 14, 1935. *Courtesy, U. S. Weather Bureau, Washington, D. C.*

summer of 1934, dust originating in the Great Plains was observed and collected in Washington, D. C. In the airway meteorological service of the Weather Bureau, the condition is recorded as "dust" when dust is present, and the visibility is from 1 to 6 miles, and "thick dust" when the visibility is less than 1 mile. In addition to producing disagreeable dust storms, turbulent winds over loose bare soil cause much damage by drifting and loss of fertile top soil. Dust storms similar to those originating in our Great Plains are frequent in the dry plains of northern China, and in other parts of the world.

When precipitation begins in an air mass carrying large amounts of dust, or falls through such a mass, the rain or snow gathers the particles as it falls, and reaches the earth as "muddy" rain or discolored snow, leaving a coating of soil on exposed surfaces. Noticeable dust falls usually occur in this way, mixed with falling rain or snow. At Cheney, Nebraska, on May 12, 1934, there was a fall of colored hail, the stones looking much like small balls of clay, owing to the accumulation of yellowish dust. At Madison,

Wisconsin, on March 9, 1918, dust amounting to 13.5 tons per square mile was deposited with snow and sleet, giving it a light yellowish tint. Microscopic examination of this dust showed that much the greater part of it was of mineral particles, ranging from 0.008 to 0.025 millimeter in size, but it also contained fragments of leaves and other vegetable matter, including fungi and spores. Its origin was probably in Oklahoma or Kansas.

Occasionally a slackening of the dust-bearing currents permits a rapid settling of the dust, without accompanying condensation, resulting in a dry dust fall of considerable proportions. At Lincoln, Nebraska, on April 29, 1933, there was a fall of dry, reddish-brown dust that continued for four hours, discoloring all horizontal objects and probably amounting to about 30 tons per square mile. Earlier in the day there were several showers of rain without any perceptible dust content, but four hours after the last rain, the dust began settling of its own weight, through quiet air, possibly aided by subsiding air.

Summary

The general circulation is modified not only by the movement of great air masses and their attendant cyclones and anticyclones but also by many lesser air movements. Of these lesser disturbances, the thunderstorm and the tornado have characteristics worthy of special attention. Both are due to active, penetrative convection.

A thunderstorm is a local storm in which lightning and thunder occur, attended by rain and frequently also by hail. It proceeds from a cumulonimbus cloud marked by a rapid and turbulent updraft of air. The violent movements of the air break the raindrops into spray, resulting in the accumulation of positive electrical charges in the lower front portion of the cloud, except the extreme front, and negative charges in the rest of the cloud. The strong electrical fields thus produced are discharged by flashes of lightning between clouds or between cloud and earth. The upward

movement is due to instability produced by surface heating or by abnormally cold air aloft, or owing to the pushing up of warm, moist air by denser air.

Thunderstorms are frequent in tropical regions, where temperature and humidity are high, and they are rare in polar regions. The frequency also varies for meteorological and topographical reasons not directly related to latitude. In the United States, thunderstorms are most frequent in the east Gulf states and least frequent along the Pacific coast. Thunderstorms may occur at any time, but they occur most frequently during summer afternoons, over most land areas, and during winter nights over oceans.

When the contrast between warm surface air and cold air above is very great, a small violent whirl about an approximately vertical axis sometimes develops in connection with a thunderstorm. The whirl forms a cloud funnel, extending from the base of the cumulonimbus toward or to the ground. This is the dreaded and destructive tornado, within which the winds develop velocities of 200 to 300 miles per hour. Tornadoes occur along an abrupt cold front of strongly contrasting air masses. Such contrasts are of frequent occurrence in the central portion of the United States in spring and early summer, when polar Canadian and tropical Gulf air meet. For this reason tornadoes are more common in that region than in other parts of the world, but they occur in many other regions. Tornadoes occurring at sea are called waterspouts.

When pressure differences on opposite sides of a mountain ridge cause air to rise up one slope with condensation and precipitation as it cools, and then to descend on the other side, the adiabatic processes involved result in its reaching the plain on the leeward side as a warm and dry wind, known as a foehn wind or chinook. Winds heated by moving over hot dry regions are called siroccos. A sudden change from a warm air mass to a much colder one is known as a cold wave. The word blizzard is applied to any storm with strong cold winds and driving snow. In dry regions

with soil of fine texture, turbulent, unstable winds sometimes fill the air with fine dust, which may then be carried great distances by the upper winds. Rain and snow may collect the dust as they fall through it, and reach the earth muddy or discolored. At other times there is a "dry precipitation" of dust, sufficient to form a considerable coating on objects at the earth's surface.

Problems

1. Air starts at an elevation of 2,000 feet and a temperature of 60° and rises over a mountain at 7,000 feet, condensation beginning at 4,000 feet. What is its temperature when it has descended on the other side to an elevation of 1,000 feet, assuming that the gain of heat by radiation and conduction is equal to the loss?
2. Why are thunderstorms very frequent at Tampa and Santa Fe?
3. Foehn and katabatic winds are both descending winds. Why is one warm and the other cold?

CHAPTER X

Weather Forecasting

The hope of being able to foresee future weather conditions furnished the principal impetus to the development of the weather map and the organization of government meteorological services. The practical value of an accomplishment enabling man to "prophesy with a near aim of the main chance of things" is evident. Daily forecasting is a matter solely of studying the weather map, including such upper air data as may be available. The weather map makes it evident that day-to-day weather is largely controlled by the movement and interaction of differing air masses and the resulting development and motion of cyclonic depressions and anticyclones. *The primary fact in forecasting is that weather travels.*

Forecasting by Study of Pressure Systems

From the beginning of the use of weather maps until very recently, the chief attention of forecasters has been centered upon the moving cyclones and anticyclones of the weather map, considered as entities. The chief effort has been given to estimating the paths and velocities of these highs and lows and their influence on the weather as they passed. Since the forces controlling their movement and changing intensity are unknown in detail, rules for forecasting are necessarily empirical. After a long and intimate familiarity with weather maps, the forecaster develops the ability to judge with considerable accuracy what changes in existing weather to expect under given conditions. The practice of forecasting, though based on certain funda-

mental physical principles and facts, is more of an art than a science.

Estimating path and velocity.—In deciding where a depression or anticyclone will be 24 hours later, consideration is first given to the normal or average direction and rate of movement of a disturbance in that position, and then to any reasons that may appear for a deviation from the normal. The normal movement always has an easterly component. Some of the more general criteria used in forecasting the movement of a depression are: It tends to move with the same velocity and direction as during the past 12 to 24 hours, in the absence of other indications. It tends to move parallel to the isobars in the warm sector; also to follow the isotherms, that is, to move toward an area of high temperature. It tends to travel toward the area where the greatest fall in pressure is occurring, as indicated by the barometric tendency, that is, by the amount and sign of the pressure change during the past three hours.

The distribution of pressure around the area under consideration influences its movement; the tendency is to move toward a region of small gradient, and away from a region of steep gradient. A strong high, east of a low, especially if the high is increasing in intensity or is nearly stationary, will retard the low or deflect it to the right or left. Two lows close together tend to unite. Consideration must also be given to the question whether the low is increasing or decreasing in intensity or is likely to do so within the forecast period. As indications of such changes, the temperature and moisture of the air supply are important. If the air masses comprising the low have strongly contrasting temperatures and if the warm air mass has a high humidity, the disturbance is apt to increase in intensity.

Estimating the resulting weather.—Having decided where the highs and lows on the map will be on the following day and how they will change, the question remains as to how the new distribution of pressure will affect the weather. What will be the direction and velocity of the

wind? What changes in temperature will occur? Will there be cloudiness or rain? In answering these questions, the following fundamental facts are kept in mind: (1) The wind has a direct relation to the pressure distribution. If the latter is correctly foreseen, the wind forecast should be correct both as to direction and approximate velocity. (2) Temperature changes are largely controlled by the wind: "Every wind hath its weather," more especially its temperature. The questions to be answered in this connection are: What is the temperature of the air that is expected to arrive, and how will it be modified as it moves? How much cooler or warmer is it than is normal for the season, or than the air now in the area for which the forecast is being made? (3) Cloudiness and precipitation frequently attend a moving depression.

There are three ways in which the ascent of moist air resulting in condensation may be brought about: (1) Along the warm front, warm air overtakes cooler air, and, being lighter, overruns it. Thus frequent rains occur along and ahead of the warm front. (2) Along the cold front, cold air overtakes warm air and undercuts it in a wedge-shaped mass, often resulting in rain. (3) In the warm sector of a depression there are often winds from southeast, south, and southwest. As these converge toward the center, some of the air is forced upward. In summer, if this converging air is moist, it tends to instability, and thunderstorms may occur throughout the warm sector as the combined result of *convergence* and convection.

The term *convergence* is used in a broader sense to include any meeting of winds from different directions, such as occurs in both warm and cold fronts, and in this sense convergence is a necessary prerequisite of all sustained rainfall, except such as results from the forced ascent of moist air over rising ground. The relations of precipitation to the pressure distribution are, however, complex and varied. The occurrence of rain in any given pressure situation is related to the topography and slope of the region and its

position relative to mountain chains and bodies of water, because these affect the two essential factors, namely, the amount of moisture in the air and the amount and rate of the upward movement of the air. The question of where the moisture comes from is not always answerable, because of our lack of knowledge of the movements of the air. In some cases, the source may be evident; in others, it is not.

Forecasting by Analysis of Air Masses

In recent years a method of weather analysis and forecasting, growing out of the polar front theory of the origin of lows and highs, and originating with J. Bjerknes, is coming into general use. In this method a study of air masses and their discontinuities largely displaces the study of depressions and anticyclones, as such.

Classification of air masses.—There is still considerable lack of uniformity in the classification of air masses, but the following conforms to present American usage and applies to the types of air masses that affect the weather of the United States. With reference to latitude of origin, air masses are called *polar* or *tropical*. (Sometimes a distinction is made between polar air and arctic air, and between tropical and equatorial air masses.) An air mass that originates over land is called *continental*, and one that originates over the oceans is *maritime*. We have thus the following four principal air masses: *cP*, polar continental; *mP*, polar maritime; *cT*, tropical continental; and *mT*, tropical maritime. The letter *w* added to any of these types indicates that the air is warmer in its lower levels than the surface over which it is moving; similarly, *k* indicates that the lower air is colder than the surface with which it is in contact. In addition, there are occasional air masses that appear to have descended from aloft and are called *superior* or *subsiding* air masses (*S*). They are warm and dry with relative humidity less than 40 per cent.

Air-mass analysis.—In the analysis of air masses an effort is made to ascertain (1) the extent and physical prop-

erties of each air mass, (2) the relations of the different masses to each other, and (3) the location, structure, and movement of the fronts along which the different masses meet. *Structure* of an air mass includes such properties as the temperature, humidity, and lapse rate, at different levels; whether or not there is conditional instability, whether the air is stratified or well mixed, the existence of inversions, and whether these are due to warm currents aloft or to subsidence of the upper air. A knowledge of the structure along the front involves ascertaining the slope of the front, the difference in temperature between the two masses, and the extent of mixing and turbulence at their surface of contact. Air-mass analysis, then, consists of a detailed study of the structure of the air. For successful application to forecasting, it requires frequent observations at the surface and also a network of observations aloft, by which means a third dimension is added to weather observations.

Characteristics of cold air masses.—The cold air masses occurring in the United States come either from northern Canada (Alaska to Hudson Bay), or from the northern portions of the Atlantic or Pacific Oceans. The former are *cP* air, and the latter *mP* air. In winter, *cP* air has overlain a frozen or snow-covered surface and has become very cold in its lower levels by radiation cooling in the long winter nights of high latitudes. Since cooling in the free air is not so rapid as at the surface, the temperature in such a mass usually increases from the ground up to a considerable elevation. This is a condition of marked stability; convection is impossible and turbulence is reduced. In such cold air absolute humidity is necessarily very low. Hence, *cP* air from Canada in winter brings clear, cold weather and good visibility to the United States. The depth of these polar air masses is often 5 or 6 miles. As they move southward, they usually move over warmer surfaces and become *cPk* air masses. In winter the warming is not enough to permit convection to the extent of produc-

ing cloudiness and precipitation, since the condensation level is very high.

In summer the ground in the source regions of polar continental air is somewhat warmed in the long hours of sunshine but remains cool as compared with surface temperatures farther south, and the supply of moisture is small. Hence, such air reaches us with temperature and humidity both moderately low. Daytime heating of the surface layers may result in instability at times, but such air usually remains cloudless.

Polar maritime air masses (*mP*) have characteristics that are quite different from those of polar continental air. Since in winter the waters of the north Pacific and north Atlantic Oceans are warmer than the adjacent land surfaces, and there is active evaporation from them, winter air masses moving from northern oceanic regions reach us with relatively high temperature and humidity in their lower levels (*mPw*). Over the oceans, where such masses form, the air gets rapidly cooler and drier upward from the water surface, often producing some instability, causing poor visibility, stratiform clouds, and drizzle in coastal areas. As it moves inland, the air is cooled at the surface and becomes more stable, with little cloudiness and little turbulence. In summer the relation between ocean and land temperatures is reversed and the air masses become *mPk* as they move inland and their lower layers become warmer and less stable.

Characteristics of warm air masses.—Because the North American continent narrows rapidly as it extends southward through Mexico into tropical regions, little true *tropical continental* air ever invades the United States. In summer, however, northern Mexico and adjacent portions of our own southwest are in the subtropical belt of light winds and light rainfall, and in consequence, very hot and very dry masses of air accumulate in those regions. These masses, having the characteristics of tropical continental

air, sometimes move northeastward across the United States, attended by hot and dry weather, often resulting in serious injury to crops. Sometimes altocumulus or high cumulus clouds in the afternoon give evidence of a certain amount of convection, but the humidity is very low and no rain is to be expected from such tropical air masses. The warm air masses of the southwest are often *tropical superior* air rather than tropical continental.

The tropical maritime (*mT*) air that affects American weather has its sources either in the subtropical high pressure belt of the Pacific Ocean between Hawaii and Lower California, or in the Gulf and Caribbean regions and the region of the Sargasso Sea. Since the water of the Pacific Ocean off the coasts of California and Mexico is especially cool for its latitude in summer, there are no summer *mT* air masses from the Pacific. In winter the temperature and humidity of *tropical Pacific* air are moderate. As such air moves inland, it is warmer than the land surface over which it travels and therefore becomes more stable. It forms a *mTw* air mass from which little condensation is to be expected except where aided by upslope effects in western mountain regions. In contrast to those of the Pacific Ocean, the waters of the Gulf of Mexico and the tropical west Atlantic are warm both winter and summer, and evaporation from their surfaces is active. Hence, *tropical Atlantic* and *tropical Gulf* air invade central and eastern portions of the United States with high temperatures and humidities at the surface, but both temperature and humidity decrease rather rapidly with elevation, often producing a state of conditional instability.

In summer, as this moist air moves over warm land areas, surface heating is sufficient to start convection, resulting in frequent and often heavy thunderstorms. In winter, the air moves over ground somewhat cooler than itself, and there is no active convection, but on account of the high humidity, low stratus clouds often form. When this trop-

ical maritime air meets and is lifted by a cold air mass, generous precipitation occurs along the fronts. It is to be noted that the hot, muggy, oppressive air coming from the Atlantic and Gulf areas is very different from the hot, dry, searing winds from the arid southwest.

Modified air masses.—When any one of these air masses moves from the area in which it acquired its characteristic properties to a region of different surface conditions, it immediately begins to be modified by the new influences to which it is subjected, and the longer it remains under the new conditions, the more the original influences are neutralized. The lower layers, especially, undergo a gradual transition in temperature and humidity, while the upper layers may remain more or less unchanged, unless the mass becomes unstable. The most significant changes in their effect upon the weather are changes in stability, resulting from changes in temperature and in moisture content.

It will be seen that the properties of an air mass depend upon its history. We need to know, first, the fundamental properties of the mass, as acquired at its source. Then we should know by what path it has reached its present position and the nature of the surfaces over which it has moved, and, finally, how long it has been away from its source and subjected to modifying influences. Air may reach the Ohio valley, for example, as a southwest wind which a few days earlier moved southward from Canada as true polar air. The weather that it brings will be quite different from that brought by a southwest wind originating as tropical Gulf air. The direction of the wind is not always a true indication of the history, nor, therefore, of the properties of the air.

Characteristics of warm fronts.—Since in a typical warm front, warm air is moving up a slightly inclined surface (Fig. 67), gaining elevation slowly but steadily, a uniform cloud layer begins near, and parallel to, the front, and extends a considerable distance ahead of the front. If the relative humidity is low, rain may not begin until a

considerable elevation is reached by the moving air, and the rain area is then some distance ahead of the front. The cloud system preceding a warm front is characteristically altostratus, changing to nimbostratus, and giving long-continued, steady rain, generally slow and sometimes only a drizzle. As the front passes, there is a change in the direction of the isobars toward the low pressure area, a less rapid fall in the barometer, and often a change to higher temperatures. However, surface temperatures become much modified by local conditions and the temperature change may not be evident.

Characteristics of cold fronts.—Along a cold front, the temperature contrast between the two masses of air is usually greater than that along a warm front, and the slope of the discontinuity steeper. Cirrus and castellated alto-cumulus clouds may precede the front, but the typical clouds appearing with a cold front are cumulus and cumulonimbus, and the rainfall is of the shower type, often heavy, but of short duration. With the passage of the front there is usually a change in the direction and an increase in the velocity of the wind, a rapid rise in the barometer, and a considerable fall in temperature.

Occluded and upper fronts.—When the cold front of a depression overtakes the warm front and cuts off the warm air at the surface, the depression is said to be occluded. The two fronts merge into one occluded front, where cold air from the west meets cold air from the east. Although these masses of air are both called cold, they probably differ considerably in temperature, and the warmer one is forced up by the colder. Warm currents which have been displaced from the surface may continue to blow at greater elevations, and there meet cold air masses along a front which does not appear at the ground level at all, and is therefore called an *upper front*. Cloudiness and rainfall often occur along the line of occluded and upper fronts, because in each case, air is being forced to ascend, but the characteristics of these fronts are less definite than those of

simple warm and cold fronts and depend upon whether the eastern or the western air mass has the higher temperature.

Identifying air masses and fronts.—The characteristics just described are used in identifying air masses and in placing the fronts in their proper positions on the weather map. The following considerations should also be kept in mind: Fronts persist from day to day, and the position of a front on any one map is a consistent development from its position on the previous map. A well-developed discontinuity is usually marked by an area of clouds and precipitation, more or less parallel to it. In the warm sector of an active depression the isobars are nearly straight lines and uniformly spaced. As previously stated, the properties of an air mass change as it moves away from the influences which have given it its characteristics. The modification is greatest in the lower layers, where there is conduction of heat to and from the earth and much turbulent mixing of the air, and where evaporation and condensation alter the moisture content. These influences so alter the lower air that it is often impossible to recognize its source by its surface properties. Since the moving masses of air change more slowly at higher elevations, the importance of upper air observations in classifying air masses is evident.

Conservatism.—Even in the upper air, however, temperature and relative humidity may change greatly within a short period. A general uplift or subsidence of an air mass is of not infrequent occurrence; this results in dynamic cooling or warming and a consequent increase or decrease in the relative humidity. Hence, upper air observations on successive days may give quite different temperatures and humidities in the same air mass and mislead the forecaster into thinking that one mass has been replaced by another. The potential temperature remains the same with changing elevation as long as there is no condensation or evaporation, and the *equivalent potential temperature* is unchanged even by alterations in the water content. (See

page 107.) The equivalent potential temperature is therefore called a *conservative property* of the air. It changes very slowly. It is altered slightly by the evaporation of rain or fog and may be changed by the absorption or radiation of heat or by mixing with other air. These processes act slowly on large air masses above the surface layers. Accordingly, an air mass can be identified more definitely by its equivalent potential temperature than by its actual temperature or even its potential temperature.

Similarly, *specific humidity* (see page 48) is a much more conservative property of an air mass than is relative humidity. The latter changes rapidly when the temperature changes, but temperature differences in themselves have no effect on specific humidity. That remains constant as long as the original composition remains the same. The only processes that alter the specific humidity are the actual addition or removal of water vapor. Dew point is also a more conservative element than relative humidity, because dew point is a function of absolute humidity, which changes more slowly than relative humidity.

Another property, more conservative than dew point or specific humidity, is the *wet-bulb potential temperature*, which is the wet-bulb temperature that a parcel of air will have when brought adiabatically to the standard pressure of 1000 millibars. (Note that standard pressure for potential temperatures differs from the "standard atmosphere," page 27.) The wet-bulb temperature is the lowest temperature to which air can be cooled by evaporation of water into it. Hence, though evaporation reduces the temperature of the air, it leaves its wet-bulb temperature unchanged. In like manner, the condensation of moisture releases latent heat but does not alter the wet-bulb temperature. Accordingly, the wet-bulb potential temperature is not changed by adiabatic processes nor by the gain or loss of moisture. It varies only by acquiring heat from outside itself or by losing heat by conduction, radiation, or mixing. Emphasis upon these conservative physical prop-

erties has come with the development of upper-air observations and air-mass analysis. They were little used when observations were confined to the surface air.

Estimating the movement of fronts.—To make an accurate forecast of the weather for the next 24 to 48 hours by the methods of air-mass analysis, it is necessary not only to predict the kind of weather that will attend the frontal movement, but also to foresee the rate and direction of the movement. Since fronts have a more or less definite association with centers of high and low pressure, the general rules applying to the movement of depressions and anti-cyclones may be applied also with little modification to the movement of the discontinuities attending them.

A few precepts relative to the movement of fronts may be summarized as follows: The movement of fronts, as well as of pressure systems, is more or less clearly indicated by the existing differences in pressure around them and by the rate of change of this pressure. More specifically, a warm front moves faster, the greater the fall in pressure in front of it within the preceding three hours, and a cold front moves faster, the greater the rise in pressure behind it. A front moves very slowly when it is nearly parallel to the isobars and increases in velocity as the number of isobars intersecting it increases. Fronts are retarded by high mountain ranges and by large, slow-moving anti-cyclones. It is to be remembered that all such "rules" are merely indications on which to base estimates, not definite fixed laws having a known physical basis. Briefly summarized, modern forecasting by the analysis of air masses attempts: (1) to identify and delimit the differing bodies of air, (2) to determine their characteristics, and (3) to foresee the changes of weather as one mass is displaced by another.

In 1933, a Norwegian forecaster, Dr. Sverre Petterssen,¹

¹ Petterssen, S.: "Practical Rules for Prognosticating the Movement and the Development of Pressure Centers," Report, *International Union of Geodesy and Geophysics*, Lisbon, 1933.

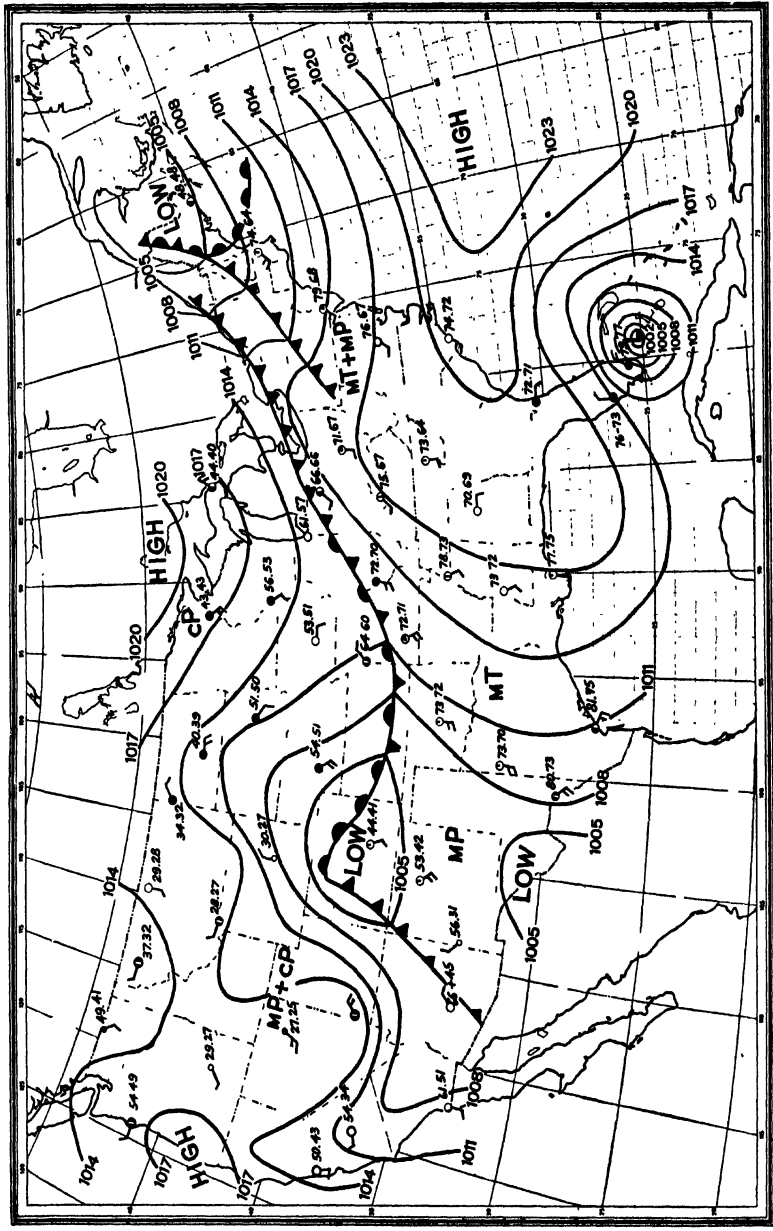

Fig. 81. Weather Map, October 6, 1941. Pressure in millibars. Temperature and dew point at right of station circles in °F

 cold front,
  stationary front,
  warm front,
  occluded front.

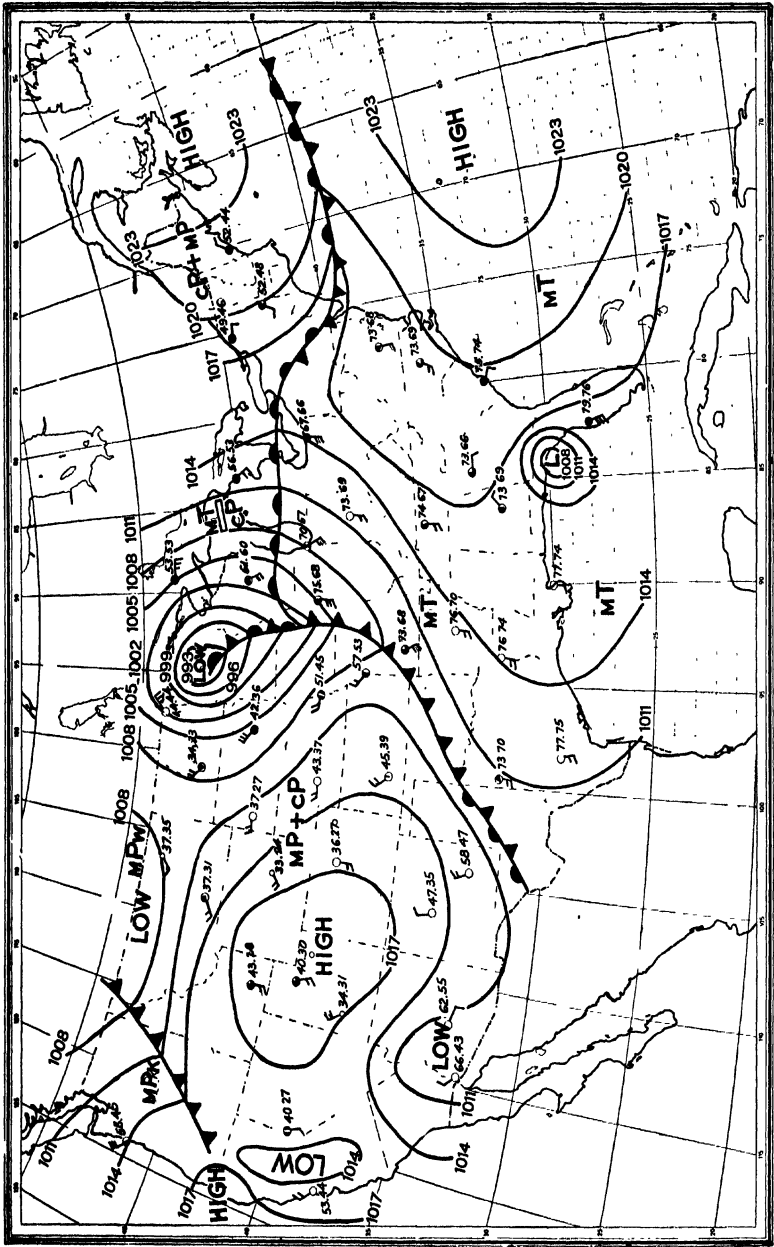

Fig. 82. Weather Map, October 7, 1941.

published a practical mathematical method for computing the movement and development of pressure centers and of fronts. His equations are expressed in terms of the pressures and the pressure tendencies along lines through the centers of highs and lows, or perpendicular to the fronts. The mathematical development is rigorous but rests on the assumption that future changes in the pressure distribution are fully indicated by the existing field of pressure as shown by the sea level weather map. This assumption is open to doubt—recent studies indicate stratospheric influences on surface pressures—but the method furnishes an additional and objective criterion for forecasting such changes.

Local Forecasts and Weather Lore

“Men judge by the complexion of the sky
The state and inclination of the day.”

Forecasts for a few hours in advance may be made without instruments or maps from the appearance of the sky, from the wind, and the “feel” of the air. They are made by everyone who looks out in the morning and decides whether to carry a raincoat or not. “When clouds appear, wise men put on their cloaks.” Farmers, sailors, and others who watch the weather closely, may become quite adept in such forecasting.

Wind-barometer indications.—A barometer will help in making such local, short-period forecasts, but its indications are not simple. The words on the dial of an aneroid barometer mean little. It is not the actual reading of the barometer so much as the kind and rate of change of pressure that are of importance. The following rules for interpreting changes in wind and pressure are published on the daily weather maps of the United States Weather Bureau:

“When the wind sets in from points between south and southeast and the barometer falls steadily a storm is approaching from the west or northwest, and its center will pass near or north of the observer within 12 to 24 hours

with wind shifting to northwest by way of southwest and west. When the wind sets in from points between east and northeast and the barometer falls steadily a storm is approaching from the south or southwest, and its center will pass near or to the south or east of the observer within 12 to 24 hours with wind shifting to northwest by way of north. The rapidity of the storm's approach and its intensity will be indicated by the rate and the amount of the fall in the barometer."

Statistical indications.—From a long series of observations at a Weather Bureau station, tables or graphs may be prepared showing the probability of rain or other weather occurrences under certain conditions of pressure, temperature, or wind direction. Thus, it was found at Dubuque, Iowa, that during the summer months, rain fell within 12 hours in 93 per cent of the cases, when the following conditions were recorded at the morning observation, namely, pressure between 29.75 and 29.85 inches and falling, temperature also falling and sky cloudy. The percentage was only 33 under conditions which were the same except that the pressure was rising and the sky clear. It was also found that the probability of rain within 24 hours was 72 in 100 in all cases when the wind was from the east and the barometer falling, and only 44 when the wind was from the northwest. This and other results are shown in Fig. 84.

Such results are local in their application, and studies of this character cannot hope to take the place of synoptic charts in forecasting. They may, however, furnish supplementary information and suggestion, and in the absence of a weather map are of value in indicating probable local weather conditions. The best results for short periods in advance are obtained by combining the use of the weather map with a knowledge of local signs, such as are furnished by clouds, wind directions, and pressure changes. This is true for short periods only. For forecasts for 12 or more hours in advance, dependence must be placed on the weather map, for the weather can change greatly in that

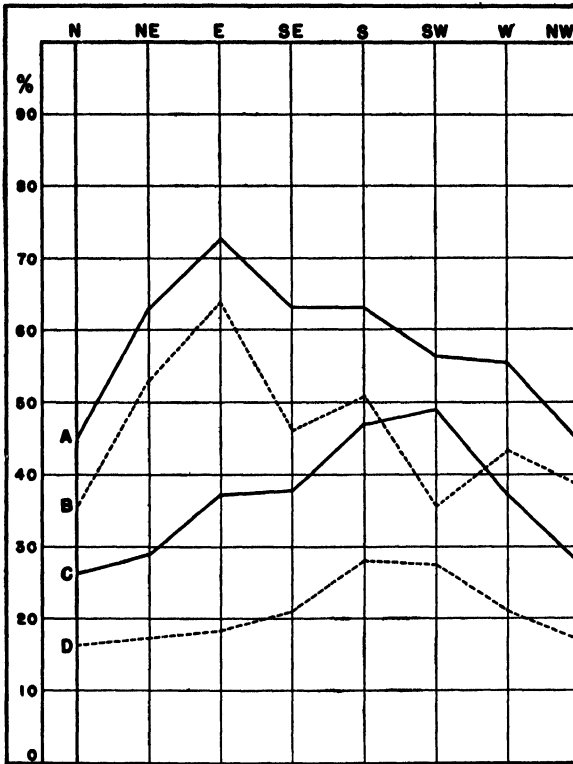

Fig. 84. Percentage of Time Rain Occurred During June and July at Dubuque, Iowa, Within 12 and 24 Hours, as Related to the Wind Direction and the Barometric Tendency at the Morning Observation; Based on 3,390 Observations. *A*, pressure falling, rain within 24 hours; *B*, pressure falling, rain within 12 hours; *C*, pressure rising, rain within 24 hours; *D*, pressure rising, rain within 12 hours.

period, and it is often misleading to try to look out of the window and anticipate tomorrow's weather from today's.

Weather proverbs.—Some of the weather proverbs relating to the appearance of the sky, the direction of the winds, and the humidity of the air, are the result of long experience and have a certain validity, similar to the statistical results mentioned above, but many of them lose their application when transplanted from the part of the world where they developed. None of them are "sure signs."

a considerable distance, and when they thicken into cirrocumulus or mackerel sky, it is a good indication that the warm-front rain is approaching, but rain does not fall in the entire area over which the cirriform clouds appear.

The conditions of plants and the condition and behavior of animals are largely responses to past and present weather influences but furnish no possible indication of future weather. The belief in such omens is suggestive of the superstitious practices of the augurs of ancient Rome. It may be true that certain plants and animals are sensitive to changes in pressure, temperature, and humidity, and for that reason their actions just before a storm may give a few minutes' warning of an approaching change. There is neither any reasonable basis nor any statistical evidence to justify an opinion that the moon or the planets have any relation whatever to the earth's weather. There is no "equinoctial storm" except in the sense that the equinoxes mark transition periods between winter and summer conditions, and storms often occur in the regular progress of the seasons during the latter part of March and of September. The long-range "forecasts" published in almanacs are generalized statements for large areas based on normals and normal variations and are verified only by chance.

Weather control.—The atmosphere is so vast and unconfined that efforts to control it to the modification of the weather seem hopeless. Man's efforts at rain-making, for example, are too small and feeble to be of value; to supply the necessary moisture and the necessary work would cost more than the rain is worth, even if it were possible. It is true that thundershowers are sometimes started by grass fires in Florida, where many thunderstorms occur naturally, but only when conditions are such that only a little additional impetus is needed to start active convection. This is an example of "trigger action," a small force serving to release and start into action a much larger force. Various attempts have been made without success to prevent the occurrence of hail. It was thought, for instance, that by

firing cannon, the hail clouds could be dissipated; or that by erecting tall poles, the electrical charge could be drawn from the clouds. (The fallacy of the latter method is that the electric charge is a result, not a cause, of the active convection necessary to produce hail.) Insurance is the cheapest and indeed the only means of guarding against losses by hail or other such weather hazards where the property subject to damage cannot be directly protected.

Summary

The basic observational data used in forecasting the weather are the surface data of the regular morning and evening observations at Weather Bureau stations, and in addition, the data, procured by pilot balloon observations, on the direction and velocity of the wind at various elevations, and the records, obtained by airplane flights, of the pressure, temperature, and humidity of the air up to a height of three miles. The information thus collected at forecast centers is entered on the weather map and on various supplementary maps and charts. The weather map shows for each station the current pressure, temperature, wind direction and velocity, and state of weather, and also the 12-hour or 24-hour amount of precipitation. Supplementary temperature maps show the departure from normal and the 24-hour change in temperature. On other charts are entered the 3-hour and the 12-hour changes in pressure, and the amount, type, and direction of movement of clouds. Charts or graphs are used to depict the results of the upper air observations.

By the use of such data and such graphical methods, the modern forecaster attempts to picture to himself the conflict between tropical and polar air and to foresee the result of that conflict as expressed in tomorrow's weather. He uses charts and graphs to make the picture clearer, but he recognizes that even with their aid it is incomplete; the details of the conflict are suggested but not completely revealed. From these charts the forecaster must (1) locate

the centers of high and low pressure and the well-marked warm and cold fronts, (2) estimate their movement and intensity during the next 36 to 48 hours, and (3) draw inferences concerning the resulting weather conditions over the area for which he is forecasting.

In locating the fronts consideration is given to (1) discontinuities in the surface temperature and wind direction, (2) pressure tendencies during the 3 hours previous to the observation, (3) dew-point discontinuities, and (4) the type of clouds and precipitation. In general, cold fronts are more distinct and more easily placed than warm fronts. The next step is to estimate the future movement and change in intensity of the pressure systems and fronts. In doing this, the average direction and velocity of movement are kept in mind and also numerous practical precepts resulting from long experience, for estimating variations from the normal behavior. Petterssen's mathematical method may also be employed. The final step is the actual forecast of weather conditions.

Some of the general principles governing the final statement of the expected weather are: The wind responds to the pressure distribution. The temperature is dependent upon the temperature of the air mass that is expected to arrive, subject to modification by insolation and radiation and by seasonal and diurnal effects. The forecasting of precipitation presents greater difficulties and uncertainties, because the occurrence of precipitation depends on the structure and activity of the air masses and fronts, upon their lapse rates and relative humidities and the amount of ascent that will occur. It is not possible as yet to determine these in sufficient detail to foresee the exact area of rain, nor, especially, to foresee the amount of precipitation. Notwithstanding these difficulties, precipitation is forecast with considerable accuracy, by a consideration of frontal action, the sources of the air supply, and its probable humidity. Topographic considerations are important in the prediction of precipitation; winds moving up slope are wet,

those moving down slope are dry. If rain has already begun, as shown by the current map, its spread in the direction of the frontal movement may usually be safely predicted. In connection with the occurrence of precipitation there are also many empirical "rules" applying to special situations and pressure distributions.

Forecasting on the basis of observations at a single station, or by statistical methods, is less successful than forecasting from synoptic charts, but such methods may give supplementary aid, and in the absence of weather maps are of value for forecasting the weather for short periods in advance.

Problems

1. Draw weather maps from data given and indicate the position of the fronts and the type of the air masses, as nearly as possible.
2. Estimate the position of the lows and highs and of the fronts, 24 hours later.
3. From a series of weather maps make forecasts day by day for your own locality.
4. Similarly, make forecasts for some distant state.

CHAPTER XI

World Weather

A study of the general and secondary circulations makes it evident that the atmosphere is very fluid and mobile, and acts as a whole. Anything that happens in one part of it affects it all. The weather is not the same in all parts of the world, but there is a connection, and what is happening here depends in part on what has previously happened elsewhere. Local weather is a small portion of world weather. There are several phases of this interdependence of weather in different parts of the world, but first we may call attention to the characteristic changeableness of the weather outside of the tropics.

Variability of the Weather

The weather vane has long been a symbol of fickleness. Change and variety are characteristic of the weather outside of the tropics, in contrast to the monotony that often prevails in trade-wind and equatorial climates.

Combinations of weather elements.—The weather elements, such as temperature, precipitation, wind direction and velocity, humidity, sunshine, and cloudiness, are all continuously variable within rather wide limits, and to a certain degree independently of one another. Hence, the number of possible combinations among them is very great. When 1,440 minutes of changing atmospheric conditions are combined to make a day of 24 hours, the number of possible permutations of the weather elements becomes almost infinite, and we see why no two days, as no two human faces, are exactly alike. If we combine this infinite variety

of days into weeks, months, and years, we again multiply the number of possible arrangements.

It is evident at once, however, that we do not experience our weather entirely by a random sampling of the possible combinations of the weather elements. There is, for example, the seasonal control of temperature; in the United States we do not have zero temperatures in July nor 100° in January. It is also clear that the different meteorological elements do not vary with complete independence. There is an evident correlation between wind direction and temperature, between wind direction and rainfall, and between sunshine, cloudiness, and rainfall. The number of combinations is considerably restricted by these relations and further limited by the fact that the weather of a given day is not completely independent of the preceding day's weather, as will be noted in the next section. In spite of these limitations, each day is unlike every other, and sometimes the changes from one day to the next are extreme. At Chicago the temperature fell from 74° at 4 P.M., November 11, 1911, to 13° at 12:30 P.M., November 12th, a fall of 61° in $20\frac{1}{2}$ hours. This is an extreme case, but wide variations in temperature from day to day are frequent in the winter months throughout the central and eastern portions of the United States. Rapid and large falls are more frequent than similar rises.

Monthly and annual variability.—When these erratic days are combined into weeks and months, and the months into seasons and years, we get an immense number of possible groupings and an infinite variability of detail. Months whose average conditions are the same may in fact be very different, when compared, from day to day. The average temperature of the month of February, 1933, at Des Moines, Iowa, was nearly normal, but half the month was extremely cold, and the other half was unusually warm. There were no normal days, but the month was normal! Rainfall may be equally erratic. The average precipitation of 57 Novembers from 1878 to 1934, at Lincoln, Nebraska, is 1.22

inches, but only three times has the actual amount been within 10 per cent of that average. The average is made up of many dry Novembers and a few very wet ones, one with more than 7 inches. Of the 57 Novembers, 29 had less than the average, 18 more than average, and 10 had more than twice the average.

Frequency curves.—The distribution of the various amounts of precipitation in January at Cleveland, Ohio, for 64 years, is illustrated in Fig. 85, which is called a frequency polygon. It will be noted that the figure is one-

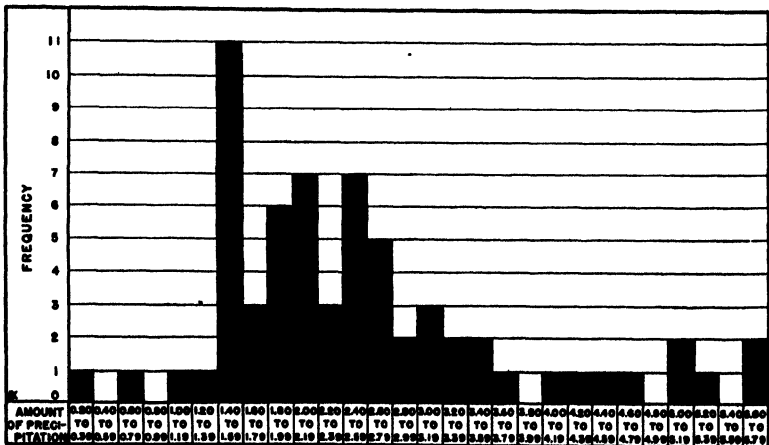

Fig. 85. Frequency Polygon of January Precipitation at Cleveland, Ohio, 1871-1935. Mean, 2.54 inches; median, 2.23 inches; mode, 1.40 to 1.59 inches.

sided; there are more small values than large ones. The average, or mean, value is 2.54 inches, but the most frequent value, or mode, is from 1.40 to 1.59 inches, and 2.23 is the median, or middle value, when the amounts are arranged in the order of their magnitude. Rainfall usually has an unsymmetrical distribution, often more so than is shown in this case, especially in drier regions. In parts of the semiarid west a rainfall of 12 inches in a year is considered sufficient for the growing of dry-land grains, but in

that region an annual average of 12 inches is usually made up of a few years of much more than the average and many years with amounts somewhat less than average. The farmer using the land under these conditions should realize that the land will receive less than 12 inches of precipitation more than half of the time.

In general, temperature data are arranged according to chance and, when plotted, form a symmetrical curve in which the mean, median, and mode coincide. This is illustrated in the polygon and curve showing the variations in the length of the growing season at Indianapolis, Indiana, Fig. 86. Frequency curves may be drawn by inspection

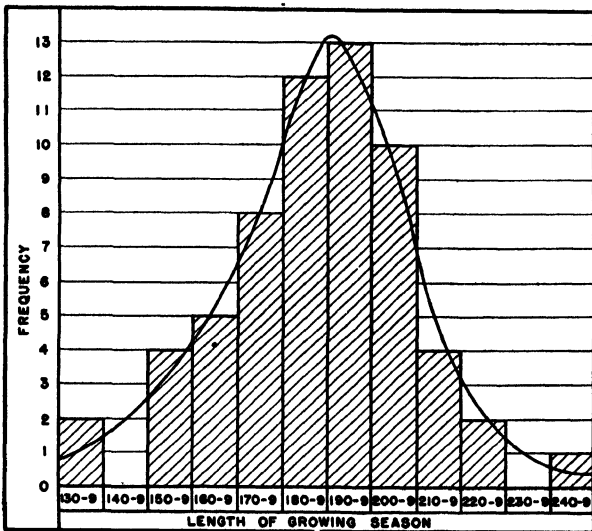

Fig. 86. Frequency Polygon for Length of Growing Season at Indianapolis, Indiana, 1874-1934, and Curve Showing the Probable Distribution of Frequencies in a Very Long Record. The curve is approximately symmetrical about the mean value. Mean, 188 days; median, 189 days; mode, 190-199 days.

as in this figure, but if a more accurate representation of the data is required, the algebraic equation of the curve may be calculated. Mathematical considerations also enable us to determine how often the rainfall will fall below or exceed any given amount, or to determine the probability

of a killing frost after a given date in spring or before a given date in autumn.

By such mathematical means it becomes possible from the examination of a limited number of observations to obtain a reasonable estimate of events as they will occur in the future on the average, a more accurate estimate than can be obtained by simply counting the number of times the given events have occurred in the past. Of course, it is not possible in this way, nor in any other way now known, to say just when the favorable or unfavorable seasons will occur. They may appear to happen fortuitously, but in the long run they will occur the number of times indicated by the curve, and it is the performance of the weather and the yield of the land in the long run that determine values, though to the individual owner the events of a few specific years may be of first importance.

Persistence of the Weather

In contrast with the character of changeableness which we associate with atmospheric phenomena, we sometimes find the weather in a less fickle mood. There are times when similar weather conditions continue day after day for considerable periods. The persistence of the weather is illustrated by what are called weather "spells" and weather types.

Weather spells.—Such phenomena as the occurrence of rain on several successive days and the persistence of hot weather for a week or two are familiar, and familiarly called rainy spells and hot spells. It appears that when one kind of weather is established, it has a tendency to continue for several days; if it rained yesterday, the chances of rain today are better than if it was fair yesterday. The general probability of rain at Paris, France, is about 0.5; that is, it rains on half the days of the year on the average, but Besson¹ has shown that if it has rained the preceding day,

¹ Besson, L., "On the Probability of Rain," (translated by B. M. Varney) *Monthly Weather Review*, Vol. 52 (1924), p. 308.

the probability rises abruptly to 0.7 and continues to increase with the number of successive rainy days up to a value of 0.8 for the 15th day of rain. This means that if it has rained on 14 consecutive days at Paris, the chances that the rain will continue another day are 60 per cent greater than the chance of rain on any day at random. In the Missouri Valley, where the general probability of rain is about 0.4, the probability increases until about the 9th consecutive day and is then 60 per cent greater than the general probability.

In general, isolated days of rain and periods of two or three rainy days are less numerous than they would be by chance, and long wet periods are much more numerous. At Paris there have been 6 periods of 25 or more successive days of rain. At Lincoln, Nebraska, within 40 years there were two such periods of 16 days; purely as a matter of chance, this should occur but once in 15,000 years. These are illustrations of the fact that today's weather is not independent of yesterday's. As mentioned in the previous section, there are times of rapid variability of the weather, but, on the average, similar weather tends to persist for several days. Reasons for this persistence may be found in the influence of the semipermanent areas of high and low pressure of the general circulation, and in the slow movement or stagnation of cyclones and anticyclones, resulting in the continued inflow of warm air or outflow of cold air.

Weather types.—Further examination of the records discloses persistence of another kind. We find periods in which the abnormal conditions are not absolutely continuous, day after day, but in which the same kind of weather recurs frequently. It is evident that months of unusual departures, having very heavy rain, for example, or averaging markedly cold or hot, indicate the continuance of abnormal conditions for at least the greater part of a month. Do such departures continue for more than a month? Fig. 87 shows the deviation of the mean monthly

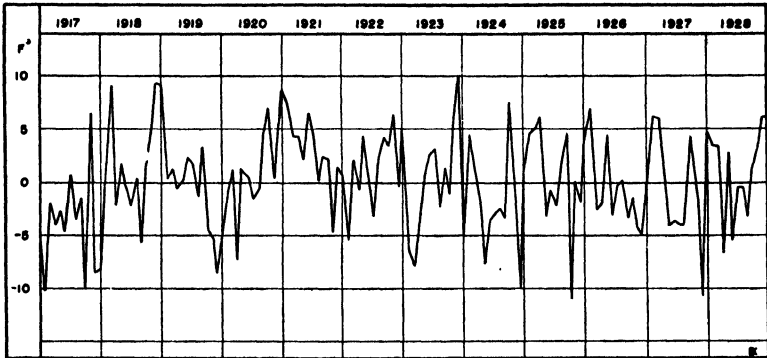

Fig. 87. Departures of Mean Monthly Temperatures from Normal, St. Paul, Minnesota, January, 1917, to December, 1928.

temperatures from the average at St. Paul, Minnesota, for each month in succession from January, 1917, to December, 1928, inclusive. It will be seen that there are frequent alternations above and below normal, but these do not appear to be systematic; no law of variation is evident. Note that November, 1917, was a very warm month between two very cold ones; from October, 1921, to August, 1922, there were fairly regular monthly variations between positive and negative departures, and January, 1924, was a cold month separating two warm months. Yet more often than not we find two or more months in succession on the same side of the normal. Each of the first 6 months of 1917 was colder than normal, and the 6 months from October, 1918, to March, 1919, were all warmer than normal. Note especially the long "warm spell" in 1920 and 1921, when there were 14 consecutive months with positive departures. In 1924 there was a period of 6 cold months, and there are a number of other periods in this short record with from 3 to 5 months having departures of the same sign.

This illustrates the tendency for similar temperature departures, that is, similar types of weather, to continue for several months, but, as has been seen, there are many

exceptions. Rainfall curves show variations of the same kind. There are dry seasons with the rainfall deficient for several months in succession, and, at other times, wet periods of a few months' duration.

These are examples of the fact, with which students of weather in temperate latitudes are familiar, that similar weather conditions often persist for periods varying from a week or two to several months, and then change abruptly to weather of quite a different character. However, the tendency to persist is not controlling and not sufficiently reliable to form a basis for forecasting the character of future months. The persistence of a given type of weather probably means that the general pressure distribution remains approximately the same, and that depressions or anticyclones of like characteristics follow one another in succession along about the same paths.

In a warm winter in the United States, for example, many lows move across the northern border, and few cold air masses push southward from Canada. In a wet season in the Mississippi Valley, many depressions originate in the southwest and travel northeast, bringing much moist air from the Gulf of Mexico. The change to another type of weather occurs when the highs and lows take a different course. The reason for their taking a different course is to be found in some alteration in the general circulation. In the Northern Hemisphere such changes in the general circulation are usually shown by modifications in the position and intensity of those seasonal centers of action, the Aleutian and Iceland lows, the Bermuda and Pacific highs, and the continental highs of winter over Canada and Siberia. The reasons for these changes are not known; some possible causes will be suggested later.

Weather Correlations

Such changes in the general circulation as have been mentioned in the preceding section affect the whole atmosphere and consequently result in weather changes

throughout the world, but not necessarily changes of the same kind. An alteration in the paths of traveling disturbances may bring unusually wet weather to one region and dry weather to another, or cold air to some areas and warm to others. Furthermore, the response to pressure changes is not immediate; there is a time lag between cause and effect. A rise of pressure in one part of the world may show itself several months later in changed weather conditions in a distant part of the globe, not necessarily in the same hemisphere.

Correlation coefficients and regression equations.—A correlation coefficient is a numerical quantity that expresses the degree of linear relationship or correspondence between two sets of data. It is computed by a mathematical process which takes account of and compares the individual deviations from average of the two sets of data year by year. The numerical value of the coefficient varies between zero and one. A value of $+1$ indicates that the two sets of data vary in exactly the same way and in the same proportion. A value of -1 shows an exactly opposite variation; when one rises, the other falls. A zero value indicates no linear relation. For example, when the average pressure during the summer months at Honolulu is compared for a series of years with the average temperature during the following winter months in the Missouri and upper Mississippi Valleys, a correlation coefficient of -0.599 is found. This indicates a tendency for high summer pressures at Honolulu to be followed by cold winters in the Missouri and upper Mississippi Valleys, and low pressures by warm winters, but the relationship is not close enough to be of forecasting value. To give a correct indication more than half of the time, the coefficient must be greater than 0.7 .

There is a similar relation between the pressure in South America and subsequent rainfall in India and temperature in Japan. If the pressure is unusually high in Argentina and Chile during March and April, there is likely to be a

heavy monsoon rainfall in India in the following July and August, and a warmer than normal August in Japan. There is a negative correlation between summer rainfall in Cuba and the next winter's rainfall in southern England; a relation between the spring temperatures in Siberia and the summer temperatures in California. Many other correlation coefficients have been obtained, showing the existence of similar correspondences between widely separated areas. There is a well-known negative correlation between the pressure over Iceland and that over the Azores. When the Iceland low is unusually deep, the Azores high is also strongly developed, and likewise when the low is shallow, the high is weak. A similar oscillation occurs in the north Pacific Ocean between the Aleutian low and the Pacific high. In the Southern Hemisphere there is a negative correlation, or seesaw, of pressure between the south Pacific and Indian Oceans.

By further statistical processes the relation of the weather in one part of the world to previous conditions in two or more other places may be expressed as a single numerical quantity, called a *multiple correlation coefficient*, and, finally, an equation may be developed for calculating the departures from normal at the one place from the known departures from normal at the other places. For example, the spring temperature in the Missouri and upper Mississippi Valleys is correlated with the summer pressure three seasons earlier, positively, at Midway Island in the Pacific, and negatively, at Lagos, Nigeria, in West Africa. From these relations we get the equation:

$$T = 0.34 P_1 - 0.51 P_2$$

where T equals the departure from normal of the spring temperature in the Missouri and upper Mississippi Valleys; P_1 equals the departure of the previous summer pressure at Midway Island; P_2 equals the departure of the previous summer pressure at Lagos. Temperature is expressed in degrees Fahrenheit and pressure in inches of

mercury. The extent of the agreement of the calculated values with the actual values is indicated in Fig. 88. The record is short, and the agreement hardly justifies the use of the equation for forecasting purposes. In India a similar equation has been developed and is in official use for forecasting the general character of the monsoon rains sev-

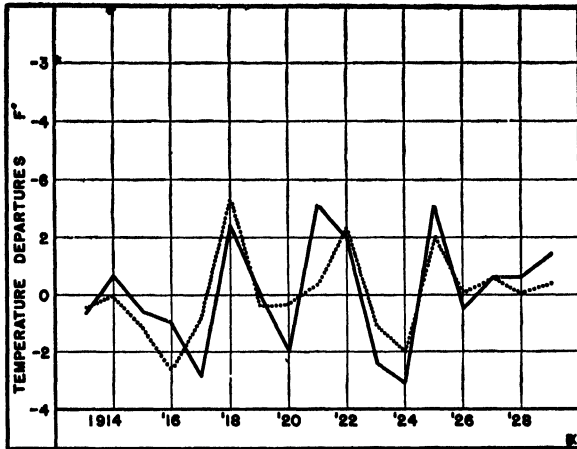

Fig. 88. Observed and Calculated Values of Spring Temperature Departures in the Missouri and Upper Mississippi Valleys. Calculations based on the pressure departures of the preceding summer at Midway Island and at Lagos, Nigeria. Solid line, observed values; dotted line, calculated values.

eral months in advance. Like equations have been obtained and tried out in other parts of the world, but in general the results are not accurate enough to warrant their use.

It is evident that these relations between distant weather conditions are expressions of the unity of the air. The general distribution of pressure and the general circulation of the air undergo changes which are reflected in world-wide modifications of weather. It is not possible as yet, however, to trace the actual physical connection between seasonal averages of pressure at a given place and later seasonal averages of pressure or other weather elements at

a distant place. The statistical results are not supported by an adequate physical explanation.²

The Oceans and the Weather

No very extensive study has been made of ocean temperatures and ocean movements in relation to atmospheric changes, but this is a field which illustrates the world-wide relations of weather phenomena and offers hope of extending our knowledge of the behavior of the air. It is principally because of lack of data from the oceans that the complex relations between the oceans and the weather have not received more attention. Many records of water temperatures are now being obtained by ships as they travel their regular routes, and, in particular, systematic records are accumulating of the temperature of the Gulf Stream between Florida and Cuba. An adequate scheme of observations would require, in addition, a great number of continuous records from fixed positions in all the oceans.

Some relations between ocean temperature and weather.—Since water changes its temperature very slowly, the ocean waters are great conservers of heat, and by their movements they are great transporters of heat and equalizers of temperature. The heat carried by the Gulf Stream from the tropical waters of America to the north Atlantic saves the people of northern Europe many thousands of tons of coal each winter, for some of that heat is transported to the land by the winds which are warmed in their passage over the warm water.

Changes in ocean temperature not only effect changes in the temperature of the land to leeward, but they produce other, less direct, effects. Temperature variations over large areas result in a redistribution of atmospheric pressure with varied and far-reaching influences on weather condi-

² For an explanation of the methods of calculating correlation coefficients and regression equations see references in bibliography to Marvin, *Elementary Notes on Least Squares*, etc., and Smith, *Agricultural Meteorology*, or refer to textbooks on statistical methods.

tions. For instance, the presence of unusually warm water in the Gulf Stream off the southeastern coast of the United States during the winter months probably results in colder than normal weather in the eastern states, instead of warmer, as might at first be assumed. A large body of warm water tends to reduce the pressure in its vicinity and in this case would intensify the pressure gradient between the ocean and the winter high pressure area over the northern continental interior. Hence the eastern states would receive more than the usual amount of cold air from interior Canada. In the following paragraphs some specific illustrations of the interrelations of air and water conditions are given.

The northeast trades and the Gulf Stream.—The changes in the temperature of the ocean water at any one place are not due very much to the heat of the sun there nor to the temperature of the air over the water. They are due chiefly to the effect of the winds in moving the water. For example, strong, steady, northeast trade winds in the north Atlantic cause the warm surface water to drift toward the West Indies and the Caribbean Sea, resulting in an accumulation of warm water in those regions. The place of the water thus removed is taken either by colder water formerly beneath the surface or by colder water drifting in from more northerly regions. Thus, the effect of unusually strong trades is to make the water colder in the mid-Atlantic trade wind area and warmer in the Caribbean and the Gulf of Mexico.

A portion of this warm water moves through the Straits of Florida as the Gulf Stream and thence along our eastern Atlantic coast and across the Atlantic toward the British Isles and Scandinavia. The amount of water transported by the Gulf Stream is probably more than a thousand times the average discharge of the Mississippi River. Since it takes 3000 times as much heat to warm a given volume of sea water by 1° as to warm an equal volume of air by an equal amount, the effect of such a volume of water on air

temperatures is great. It is believed that enough warm water is carried by the Atlantic Drift into the Norwegian Sea each year to raise the temperature of the air over the whole of Europe up to $2\frac{1}{2}$ miles above the surface of the earth by 10 degrees for each degree that the water cools.

Polar ice and the weather.—The surface area of floating ice in the polar seas not only undergoes a seasonal change but frequently shows large variations from one year to another. An increase in the amount of ice is attended by a decrease in the temperature of the air over the ice and over adjacent regions and a related increase in pressure over these regions. In the north Atlantic, when the ice increases, the general tendency is toward a filling up of the Iceland Low and a flattening of the Azores High. This results in altering the paths of traveling depressions across the Atlantic. In particular, the amount of ice in the Greenland Sea region has been found to be an appreciable factor in variations in the weather of the British Isles and Norway.

Ocean temperatures and California rainfall.—For a number of years McEwen³ has issued each fall a forecast of the coming winter's rainfall in southern California. The basis of the forecast is largely an observed inverse relation between the water temperatures along the coast in summer and the rainfall of the following winter. The lower the summer temperature of the water, the higher, usually, is the rainfall of the succeeding winter. In recent years McEwen has modified this simple rule by taking into consideration the difference between summer and winter water temperatures and also what appears to be a cyclical trend in California rainfall.

The suggested explanation of the relationship between water temperature and rainfall is that both are closely

³ McEwen, G. F., "Methods of seasonal weather forecasting at the Scripps Institution of Oceanography," *Bulletin, American Meteorological Society*, Vol. 15 (1934), pages 249-256.

related to inflowing winds from the ocean. The higher and steadier the onshore winds, the more cool water is brought to the shore and the more moisture is carried over the land and precipitated. The air movement depends on the pressure gradient from ocean to land. In summer there is normally a considerable gradient between the Pacific high pressure area and low pressure over Arizona. Why this summer gradient, and modifications of it from year to year, should be reflected in the rainfall several months later has not been made clear, and this attempt at long-range forecasting must still be regarded as tentative and experimental, and without a complete physical explanation. The forecasts have been correct as to the direction of departure from normal about 75 per cent of the time over a 19 year period, but less successful in indicating the approximate amount of departure.

The Peru current and Peruvian rainfall.—A striking example of the effect of ocean changes upon the weather of nearby land areas occurred on the Peruvian coast of South America from January to April, 1925. Ordinarily the cold Peru current from the south prevails along those shores, somewhat mitigating the heat of the adjacent lands but causing them to be almost rainless, because the cool air is warmed as it moves inland and its relative humidity thereby reduced. During the early months of 1925 this current seems to have disappeared and to have been replaced by a warm northerly current from which warm, moist air moved inland. The reason for this departure of the ocean from its well-established habit is not known, but it was doubtless meteorological in its nature, caused by some variation from normal temperature and pressure somewhere in the world. The climatic consequences were remarkable. In desert regions where rain was almost unknown, great floods spread destruction and dismay. Counterbalancing the losses due to the unprecedented floods, came a quick and abundant growth of grass, giving the half-starved animals such a feast as they had never

before enjoyed. During April, conditions returned to normal, and such an experience will probably not be repeated for many years.

Conclusion.—The fact is, then, that ocean circulation and ocean temperature are closely connected with air circulation and air temperature. Changes in either cause changes in the other, sometimes in distant parts of the world and after the lapse of considerable time. The various influences interact inextricably, but it seems clear that a more complete knowledge of ocean currents and ocean temperatures and their variations from season to season and year to year, together with a broader knowledge of atmospheric changes over the oceans, would be of great value in interpreting what often appears to be the capricious behavior of the atmosphere.

The Sun and the Weather

The sun not only governs the movement of the world in its orbit, but, also, by its never-ending stream of radiant energy, it rules the earth's life and activity. The sun's general control of the earth's weather and climate is evident, but how detailed its regulation of the weather is, remains a question. As previously noted, there are slight variations in the flow of energy from the sun; the solar constant appears to vary slightly from day to day, and in longer periods somewhat more, up to about three per cent. Are these solar changes reflected in weather changes on the earth?

Sunspots and temperature.—One of the first results obtained in a study of the relations between solar changes and terrestrial weather was an apparently self-contradictory one. The solar constant increases, but at the same time the earth as a whole gets cooler; a hotter sun results in a cooler earth. Investigators agree in obtaining this paradoxical result, but no satisfactory explanation of it has been offered. It is open to some doubt, because it seems irrational and because the temperatures used are for land

stations and may not correctly represent the air temperatures over the whole surface of the earth.

Solar radiation and the turbulent atmosphere.—The effect of changes in the intensity of solar radiation may be to make some parts of the earth warmer and others cooler, some wetter and others drier. A change in the solar constant may cause a shifting of the pressure belts with consequent complex effects on the paths of cyclones and anticyclones and upon the distribution of temperature and precipitation. With reference to the longer periodic changes in solar radiation, especially the eleven-year sun-spot period, their relation to weather changes is confirmed by many observations, as will be indicated in the next chapter. Some students of solar variations go further than this and believe that the irregular changes in the weather from day to day result chiefly, if not entirely, from daily changes in solar radiation, and that without these the weather would repeat itself with great regularity. To most meteorologists this opinion seems wholly untenable. Our erratic, day-to-day weather appears to result from innumerable differences, both small and great, in the physical condition of the air. Even with a constant amount of heat from the sun, the physical condition of the lower air would be subject to countless local differences because of such factors as the variations in the surface covering of the earth and differences in elevation, absorption, radiation, evaporation, cloudiness, and dust.

The influences affecting the air appear to be so numerous, so immeasurable, and so unpredictable as to create a condition of extreme atmospheric turbulence defying analysis and never twice the same in detail. The turbulence of the lower atmosphere may be compared to that of a mountain brook, rushing and tumbling over a rocky bed. To predict the weather a year from today is like predicting the exact location, 24 hours later, of a chip floating on such a stream. There are doubtless slow cyclical variations in the output of radiation by the sun, and probably also daily

fluctuations. It is reasonable to assume that these affect the weather throughout the world by affecting the temperature of the earth and the air, but how and to what extent they influence weather changes are questions not yet satisfactorily answered.

Seasonal Forecasting

The object of the preceding discussions of weather correlations and solar and oceanic influences has been not so much to give definite results of immediate application as to emphasize the complexity of world weather relations. The facts now known as to these relations give us some indication of how the air behaves, but our knowledge is not sufficiently definite nor complete to enable us to explain fully the physics of the air in its larger movements. Attempts have been made to apply the existing knowledge of the world-wide relations of weather to the problem of long-range forecasting, meaning the forecasting of the general character of the weather for a month or more in advance. An attempt is made not to forecast the daily weather but rather to say whether the precipitation and the average temperature of the period under consideration will be above or below normal, and how much above or below. Seasonal forecasting is the attempt to foresee the general character of a future season, for example, to determine whether the coming winter will be warmer or colder than normal. Such attempts are usually made for seasons not more than 6 to 9 months in the future.

Nature of atmospheric responses.—It sometimes appears that those atmospheric responses to changing conditions that show themselves in different parts of the world are to be explained as latitudinal shiftings of the pressure belts as a whole or in large areas, such as it has been supposed may be accounted for by changes in insolation. By the shifting of the pressure belts is meant the north or south movement of the doldrums, the subtropical highs, and the polar circle lows. A movement of these belts occurs annu-

ally with the change of seasons, but if the amount of movement varies from year to year, then, obviously, there will be differences from year to year in the position and development of the trade winds and the prevailing westerlies, and in the paths of depressions and anticyclones. An abnormal position of these belts results in weather abnormalities of various kinds in many parts of the world.

Sometimes it appears that there is a wave-like swaying of the atmosphere, a resilient movement as in a jelly, as, for example, the oscillation of pressure between the south Pacific and the Indian Oceans. In cases such as this the indication is that the air has a natural period of vibration, a swinging backward and forward, which continues indefinitely, or at least for a considerable period when once started. At other times it seems that, when an abnormal condition has been imparted to a large mass of air, the abnormality tends to persist, and the mass maintains a separate existence and movement of its own. This often appears to be the case when successive monthly or quarterly mean pressure departures are charted on maps. The areas of positive and negative departures continue from month to month or season to season, though changing their position. Probably the atmosphere responds to external influences in each of these three ways, by a shifting of pressure belts, by a wave-like motion, and by retaining properties once acquired. It has not as yet been possible in studying seasonal weather changes to separate the effects of the three.

The hope of seasonal forecasts.—The methods of correlation have brought to light many interesting and suggestive relationships, and in a few cases have evolved usable formulas, but in general the findings of this method have failed of the degree of exactness necessary to make forecasts of real value. By their nature, correlation coefficients represent only average correspondence between two or more quantities, and can give no indication of when exceptions will occur. Probably their use in conjunction with maps

of monthly pressure departures would add to their value, but little has been done on this line, and there is no world-wide arrangement for the prompt collection of monthly means. An arrangement of this nature must be made before correlations and departure maps can be of their full possible value in long-range forecasting. Correlations deserve and are receiving considerable attention, in the effort to develop forecasting formulas of value. They seem now to offer hope of quite useful results.

Active work is also continuing on the relation of changes in the solar output of energy to future weather, and some work is being done in the collection and study of ocean temperatures and their correlation with subsequent weather. Another line of approach to the problem of long-range forecasting is the effort to find recurring cycles in the weather. This matter will be discussed in the following chapter. A consideration of the partial results obtained by the methods described leads us on with the hope that the problem of foreseeing the general weather character of a coming season or year may yet be solved. The solution does not appear impossible, but it is not yet accomplished. Such general forecasts would not help at all in foreseeing the character of a particular day. We should still have daily changes in the weather and the necessity of daily forecasts based upon a close following of the movements of air masses. But a knowledge that the coming summer would be wetter or drier than average, or the coming winter warmer or colder would make possible a kind of planned economy not practicable without this knowledge and would make or save millions of dollars for the nation. The search for an answer will doubtless continue.

Summary

The weather is both variable and persistent. The elements are combined from day to day in an infinite variety, often resulting in sudden changes in the weather. Not only do individual days differ widely, but values of tem-

perature and rainfall for the same month in successive years often show large differences, and the yearly averages of temperature and totals of rainfall are subject to considerable variation. In general, temperature data are arranged symmetrically about the average value, but the average monthly or annual precipitation is frequently not the most probable value.

In spite of the great variability of the meteorological elements, there is on the whole a tendency for the same kind of weather to continue for a few days and often, in a larger sense, for several months. When the general distribution of pressure remains essentially the same, and barometric disturbances follow one another along the same paths, or when air becomes quiescent over a large area, the same type of weather is likely to persist. A sudden change to another type is an indication of some change in the general movements of the air, marked by a change in the course of traveling highs and lows.

Since changes in the major pressure belts and in the paths of secondary disturbances affect large areas, there necessarily is some degree of correlation between weather in different parts of the world. In particular, it is evident that changes in the position and intensity of the continental and oceanic semipermanent areas of high and low pressure may result in changing the movements of air masses around the world, causing related changes in temperature and rainfall. Many relations between weather elements in distant places have been discovered by statistical methods. They are often expressed numerically by correlation coefficients.

Ocean temperatures and ocean currents are closely related to air temperatures and air movements, and changes in the condition of the ocean are often reflected in a redistribution of pressure and in subsequent weather changes over land areas. Variations in the solar constant also have their influence on the movements of the air and the other weather elements.

These are illustrations of the existence of world-wide

weather connections and evidence that the relations are complex and difficult to work out in detail. Under these complex influences, (1) the general pressure belts of the world change somewhat in position and in pressure from month to month and from year to year, (2) the atmosphere takes on a swaying motion causing a seesaw of pressure between distant places, and (3) large masses of air assume abnormal conditions which persist and by their persistence cause changes in the behavior of the air elsewhere. These kinds of responses made by the atmosphere result in correlated weather changes over the earth.

Not much more than a beginning has been made in the study of the atmosphere as a unit and of the far-reaching effects of changed conditions in any part of it. Such knowledge as has been gained of these matters keeps alive the hope of being able to foresee the general character of a season some months in advance and thus making another important application of meteorology to man's economic advantage.

Problems

1. Draw frequency polygons and frequency curves from monthly or annual temperature and precipitation tables.
2. Make graphs of successive departures from normal of monthly temperatures and rainfall and note the character of the curves with reference to variability and persistence.
3. Chart daily records of temperature and rainfall for evidences of short weather "spells."
4. Examine records over several months for evidences of weather types.
5. From World Weather Records check the correspondence between autumn pressure departures at Dutch Harbor and temperature departures for the following winter at Winnipeg, St. Paul, and St. Louis.
6. Compare the summer pressure departures at Midway Island with temperature departures the following spring at Winnipeg, St. Paul, and St. Louis.

CHAPTER XII

Climate

The sciences of meteorology and climatology inevitably overlap. No sharp line can be drawn between them. To discuss the weather adequately one must consider the frequent, usual, or average weather conditions in different parts of the world, and these are what comprise climate. To understand climate one must know something of the reasons for the various kinds of weather experienced, for climate is the total effect of all the daily weather. In the study of meteorology it is desirable, therefore, to consider also some of the main features of the climates of the earth and their relations to, and influence upon, one another and upon man and his manner of life.

Climatic Elements

The elements of weather and climate are so numerous and combine in such endless variety that the complete description of a climate is extremely difficult. Accurate description involves the extensive use of climatic tables. To be complete, these should include all the elements which affect man and his activities. To acquire from such tables a correct idea of what a given climate is like requires not only a careful comparison of the data with similar data for climates with which one is familiar, but also the exercise of some imagination.

Climatic data.—Temperature and rainfall are the two most important climatic elements, but the simple tabulation of their average annual values is not sufficient. Two places with the same mean temperature and rainfall may

have very different climates because of differences in their distribution within the year. For example, San Francisco and St. Louis each has a mean annual temperature of 56° , but San Francisco's January average is 49.9° , and St. Louis's is 31.1° ; while in July the averages are 58.5° and 78.8° , respectively. Some of the more important data to be included in climatic tables are:

Mean monthly and annual temperatures, and mean annual ranges of temperature.

Mean daily maximum and minimum temperatures, and mean daily ranges.

Highest and lowest temperatures of record.

Average number of days with maxima above 90°F. ; above 100°F. Average number of days with minima of 32°F. or lower; of 0°F. or lower.

Mean monthly and annual precipitation.

Greatest and least monthly and yearly amounts of precipitation.

Greatest precipitation in 24 hours.

Excessive amounts of rainfall for short periods.

Average snowfall by months.

Average number of days with rain, snow, hail, fog, thunder.

Mean cloudiness in tenths of sky covered.

Mean percentage of sunshine by months.

Mean wind velocity by months.

Prevailing wind direction by months.

Mean frequency of winds from the different directions.

Mean frequency of gales.

Average and extreme dates of first and last killing frosts.

Solar and physical climates.—If the earth were a uniform land surface without an atmosphere, the temperature of the surface at any given place would be governed directly by the amount of insolation received there. The annual amount of insolation is greatest at the equator and least at the poles, and, under the conditions assumed, we should have a regular decrease of temperature from equator to

poles. The actual air temperatures over the earth, as it is, follow this plan of distribution in main outline but not in detail. In so far as the climate of a place depends directly on the amount of solar radiation received, it is called *solar climate*.

The division of the earth into the five classic zones bounded by the Tropics of Capricorn and Cancer and by the polar circles is of ancient origin and is purely on a solar climate basis. These are zones of possible sunshine rather than of actual climate. Within the tropics, the sun is vertically overhead at noon at least once each year, twice each year except at the actual latitude of the tropics. Within the polar zones, the sun is below the horizon for at least 24 consecutive hours in winter and above for at least 24 hours in summer. In the intermediate zones, the sun is never in the zenith and never below the horizon for 24 hours. The latitudinal zones, notwithstanding their old names of torrid, temperate, and frigid, merely mark differences in the elevation of the sun.

The actual or physical climate does not follow the parallels of latitude. It is modified by geographic conditions, chiefly (1) by the irregular distribution of land and water, (2) by winds and ocean currents, and (3) by differences in elevation. These modifying influences act in various ways to produce climatic differences: land and water absorb and radiate heat differently; cloudiness and humidity are influenced by distance from large bodies of water; movements of air and water convey large amounts of heat across latitudinal lines. Nevertheless, the distribution of insolation is the primary factor determining temperature. Solar climate is the groundwork upon which modifications are imposed by other factors.

Distribution of Temperature

Except in polar regions, the normal distribution of temperature over the earth is now fairly well determined. Most inhabited land areas have temperature records of con-

siderable length. Although records over the oceans are less extensive, nearly all vessels at sea make regular observations, and since ocean temperatures are less variable than land temperatures, these serve quite well to determine the general temperature distribution. The distribution of temperature is indicated on a map by lines drawn through points of equal temperature, *isothermal lines*. For the daily weather maps and for maps of small areas, the actual temperatures are usually represented, but on maps of extensive areas, where there are great differences of level, mean temperatures are first reduced to sea-level by using a lapse rate about equal to the average lapse rate in the free air. Usually 0.5°C . for each 100 meters of elevation (2.75°F . per 1,000 feet) is added to the actual temperature. This is necessary if the lines are to show the effects of latitude and of continental land masses on the distribution of temperature. If the actual temperatures obtained at different elevations were used, these more general influences would be obscured; besides, it is not possible to indicate on a small scale map all the temperature differences found in mountainous regions. Where the isotherms shown on the maps presented in this chapter pass over elevated regions, they do not represent the actual temperatures to be found there but have been thus corrected for elevation.

Normal yearly temperatures.—The first and most obvious fact noted on examining a world chart of mean annual temperatures (Fig. 89) is the decrease of temperature from equatorial regions toward polar regions. This decrease is evidently due to the different amounts of insolation received; solar climate is dominant in determining the general course of the isotherms. They do not follow the parallels of latitude closely, however, but bend irregularly northward and southward. In equatorial and lower middle latitudes they bend poleward over the continents, indicating that the continents in these latitudes have an average temperature warmer than that of the oceans, or than the average of the latitude around the globe. In Siberia and

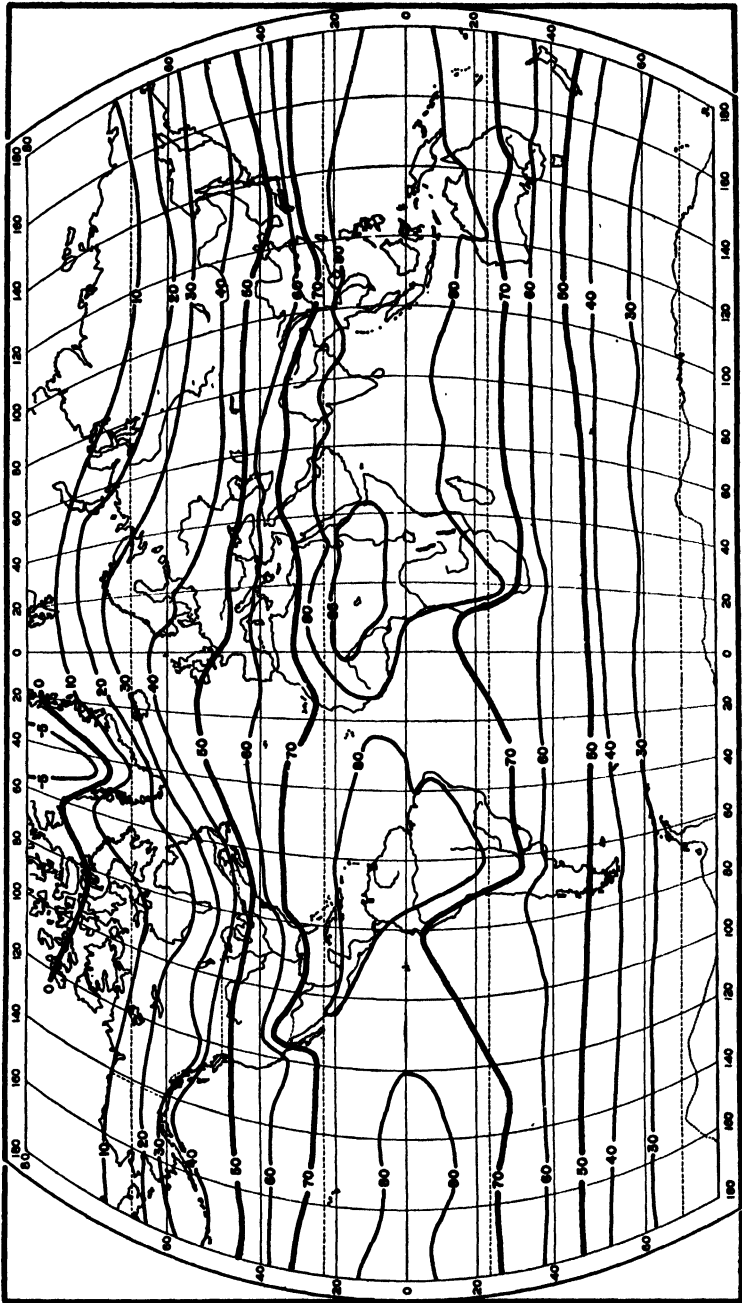

Fig. 89. Mean Annual Sea-Level Temperatures, World, °F.

northern Canada the isotherms bend southward, showing that large continental areas in high latitudes are colder than the adjacent oceans. The isotherms turn far northward in the north Atlantic, disclosing the influence of the warm water contributed by the Gulf Stream. A similar though less marked northward trend occurs in the Pacific from Japan to Alaska, along the course of the Kuro Siwo. In the Southern Hemisphere cold ocean currents flow toward the west coasts of South America and Africa, bending the isotherms equatorward.

There are thus two major influences producing the irregularities of the annual isotherms: (1) the differing responses of land and water to the influence of insolation, and (2) the transportation of warm and cold water by ocean currents. Note how these influences result in a crowding of the isotherms in Alaska and southeastward to New England, and in eastern Asia. The warmest area, as expressed by the annual means, is in central Africa where the temperature averages more than 85° . The isotherm of 80° extends around the world except for small areas in the eastern Atlantic and eastern Pacific Oceans, and includes large portions of Central and South America, Africa, Arabia, India, and Indo-China, all of the East Indies and the Philippine Islands, and a part of northern Australia. The coldest regions of the world cannot be shown so definitely because records are very incomplete for polar regions, especially for Antarctica. There is a short record from central Greenland which gives a mean annual temperature of -5°F. , and a record of one year at Framheim on the coast of the Ross Sea in Antarctica gave an annual mean of -14.4°F.

January and July normal temperatures.—An examination of the January and July temperature charts (Figs. 90 and 91) discloses the migration of the isotherms with the seasons. The January isotherm of 90°F. includes only small areas in south Africa and in Australia. In July the average temperature is 90° or over in a part of southwestern

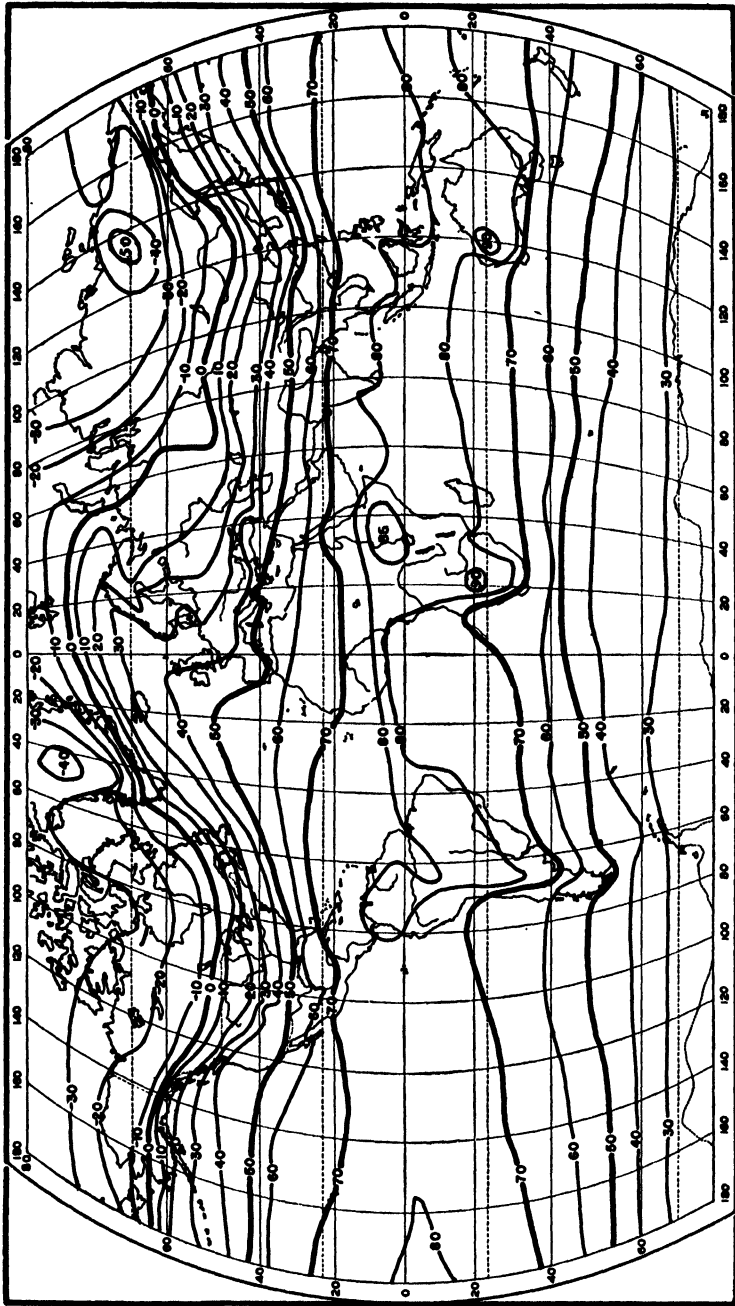

Fig. 90. Mean January Temperatures at Sea Level, World, °F.

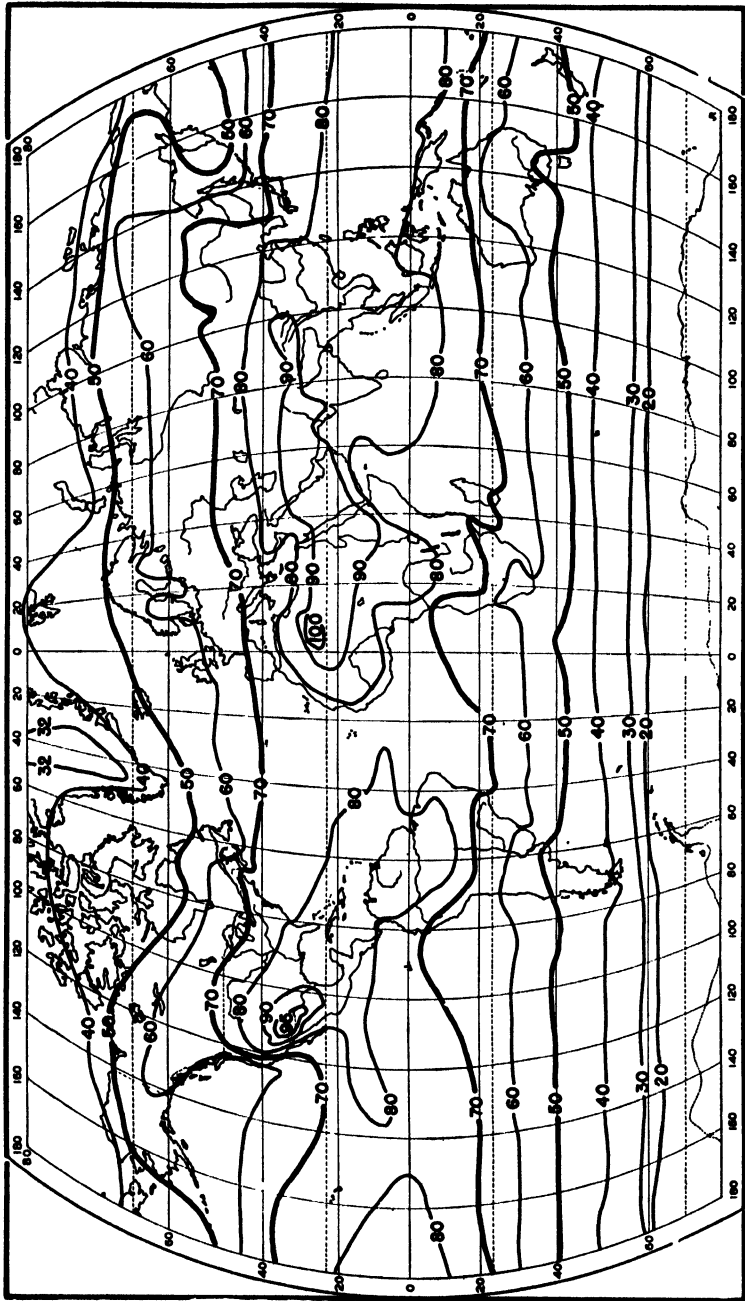

Fig. 91. Mean July Temperatures at Sea Level, World, °F.

United States and large areas in north Africa and southwestern Asia. A small area in the Colorado Valley has a July mean of 95° , and a portion of the Sahara desert, a mean of 100° . In contrast to these high temperatures, the temperature of interior Greenland remains below freezing throughout the year. In January the lowest mean temperatures are in Siberia, -50°F. , and in Greenland, -40°F. The lowest mean shown on the map for July is 20°F. along the border of the Antarctic continent, but for August, 1911, a mean of -49°F. was obtained at Framheim.

Note also the migration of the isotherm of 70° in North America; in January it crosses Mexico, and in July it has moved northward to Canada. Other isotherms should be traced on the two maps, and their movements noted and explained. The change of temperature is less over the oceans than over the lands, and, hence, less in general in the Southern Hemisphere than in the Northern. The migration as a rule is less than that of the sun, which is 47° of latitude. As a result of continental and oceanic influences, modifying the effects of insolation, the January temperature off the coast of Norway is 40° higher, while in the interior of North America and Asia it is 30° lower, than the latitudinal average. In July these *anomalies*, or departures from the average temperature of the latitude, are generally less than 10°F. , except in the interior of the United States, Asia, and north Africa, where they are from 10° to 20° .

Annual and daily ranges of temperatures.—Mean annual ranges of temperature are an expression of the average difference between winter and summer temperatures, and are shown in Fig. 92. It will be seen that mean annual ranges are much greater over continental interiors than over large ocean areas in the same latitude. They naturally increase with increase of latitude because of the greater difference between winter and summer insolation as the distance from the equator becomes greater. In the tropical oceans and across equatorial Africa and South America

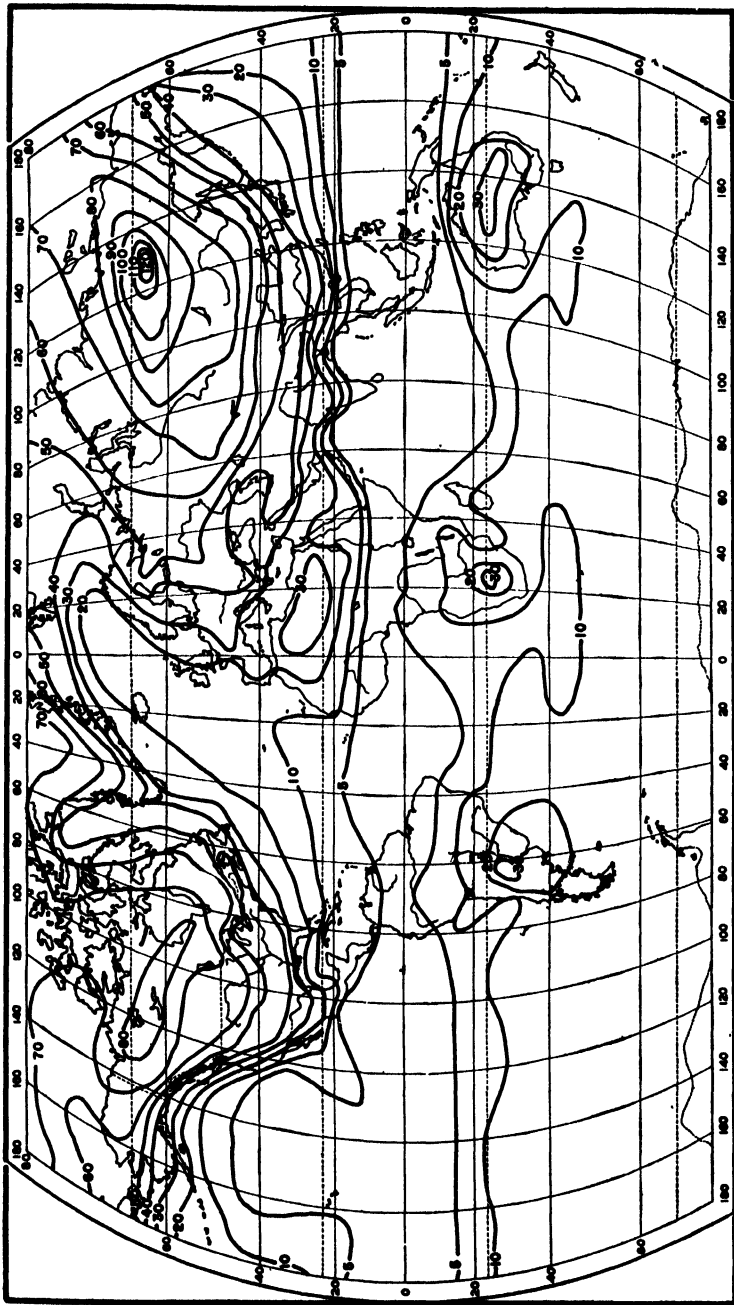

Fig. 92. Mean Annual Range of Temperature, World, °F.

the annual range is less than 5°F. It increases to 30°F. near the tropics in Africa, South America, and Australia, to 80° in the interior of Canada, and to 120° in a small area in Siberia. This progressive change shows clearly the effects of distance from equator and distance from unfrozen oceans.

In the chart of January mean daily ranges of temperature in the United States (Fig. 93), the influences of humidity and of elevation are clearly evident. In portions of the elevated, arid southwest, the average difference between day and night temperatures in January is 33°F., while in the vicinity of Puget Sound, the marine influence results in a daily range of only 9°F. Note the influence of the Great Lakes in reducing the range. Two physical principles are involved in this influence; first, the slowness of the water to change its temperature; second, the increased humidity of the air screens out some insolation by day and absorbs earth radiation by night. Note that the extent of the marine influence on the Pacific coast is greater than on the Atlantic. The Atlantic and Gulf coasts are subject to invasion by continental air.

Some extremes of temperature.—The following are some records of extreme temperatures, obtained under standard conditions of exposure, and expressed in the Fahrenheit scale:

Lowest temperature of record, -93.6° , at Verkhoyansk, Siberia. (A minimum thermometer, left for 19 years near the top of Mt. McKinley, Alaska, not in an instrument shelter, when recovered indicated a minimum temperature of approximately -100° .)

Lowest mean temperature for one month, -63.9° , at Verkhoyansk.

Lowest temperature in the United States, -66° , at Riverside Ranger Station, Yellowstone Park, February 9, 1933. (Former record, -65° , at Poplar River, Montana.)

Lowest mean for one month in the United States, -13° , at St. Vincent, Minnesota.

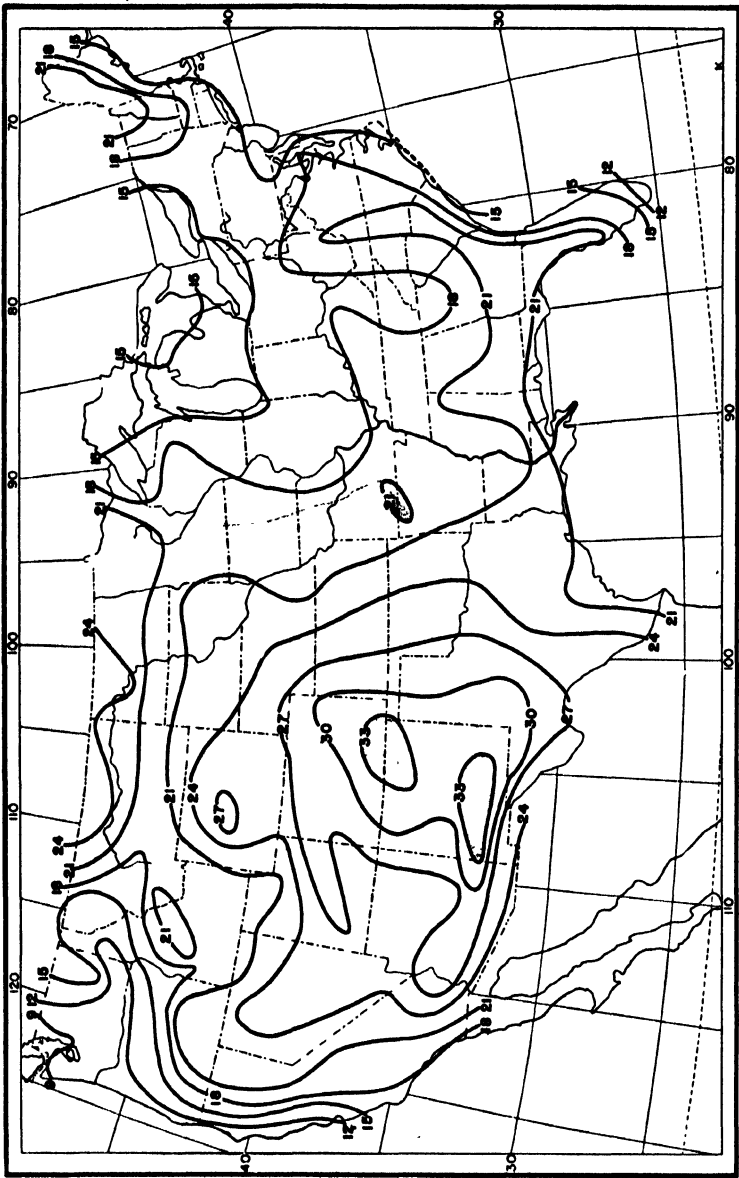

Fig. 93. January Mean Daily Ranges of Temperature in the United States. (After Atlas of American Agriculture.)

Lowest temperature in Alaska, -76° , at Tanana, in 1886.

Lowest mean for one month in Yukon Territory, Canada, -51.3° , at Dawson, December, 1917.

Lowest temperature in Yukon Territory, -80° .

Highest temperature of record, 136° , in Tripoli.

Highest temperature in the United States, 134° , in Death Valley, California.

Highest mean for one day in the United States, 108.6° , Death Valley.

Highest normal annual temperature in the United States 81.1° , Fort Stockton, Texas.

General Distribution of Precipitation

Precipitation occurs at irregular intervals and is greatly variable in amount, so that many years of record are required to obtain smooth daily, or even monthly, normals. In fact it may be questioned whether the word normal in this connection has much significance. Records on land are sufficiently numerous and of sufficient length, however, to justify the use of mean values as tentative normals, with the understanding that several hundred years of record might alter them materially. There is little exact knowledge of the average amounts of rainfall over the oceans. On a chart representing the distribution of rainfall, lines of equal rainfall are called *isohyets*. Isohyets are drawn as nearly as may be to indicate the actual precipitation; there is no reduction to sea level as in the case of isobars and some isotherms.

Normal annual precipitation.—From a map of the average annual rainfall of the world we may deduce the following general statements, which the reader should verify by reference to Fig. 94.

1. Precipitation is greatest in equatorial regions and decreases irregularly toward the poles. The decreasing amount of moisture in the air as the temperature declines from equatorial to polar regions naturally results in a smaller total precipitation. Also, the general tendency of

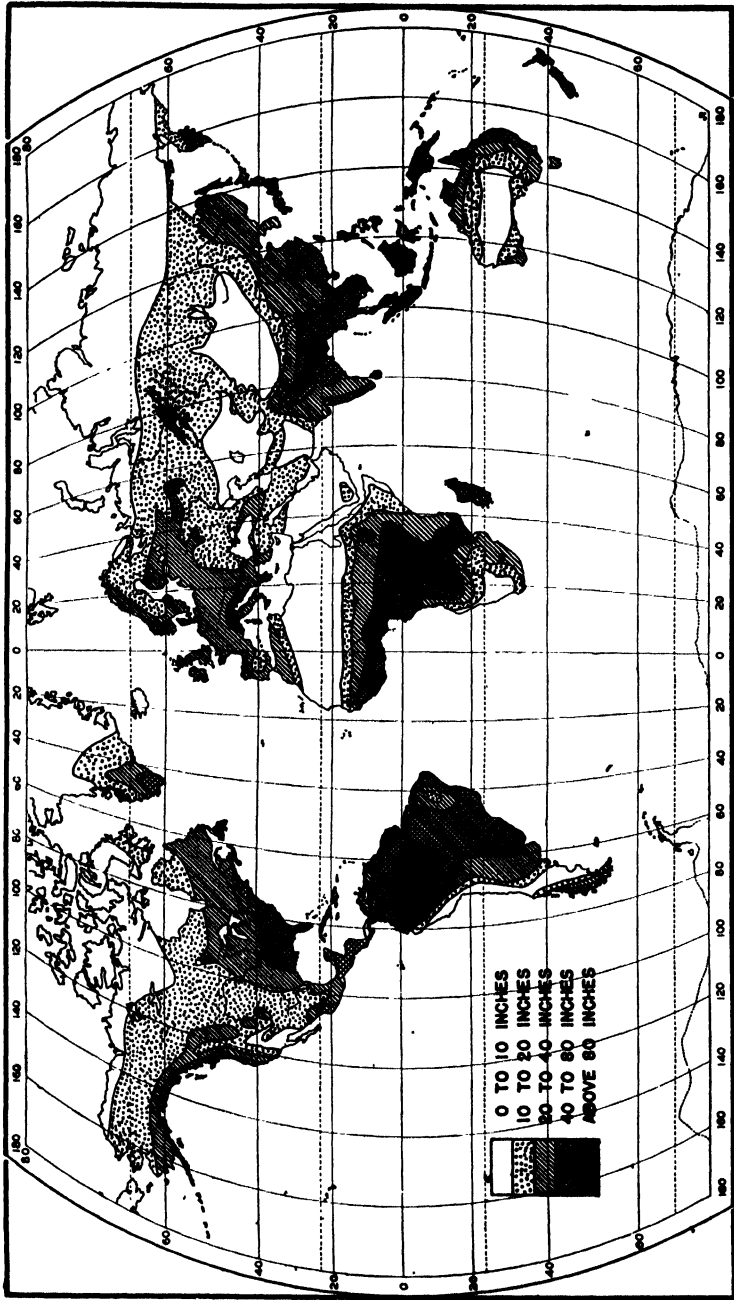

Fig. 94. Mean Annual Precipitation, World, Inches.

air to expand and rise in warm areas and to settle in cold areas leads to greater precipitation in the former as compared with the latter regions.

2. Rainfall decreases toward the interior of large continental masses, because the chief source of supply of the moisture of the air is the oceans. Much of the moisture is often precipitated on the nearby land areas, and little is left for the distant interiors. Note the large dry areas in the central portions of Asia and North America. (Other factors are involved besides the inland position of these areas.) Over large land areas there is also an important secondary source of atmospheric humidity in the evaporation from lakes, rivers, soil, and vegetation.

3. Rainfall shows a relation to the general wind systems of the world (discussed in more detail in the next section) and to the direction of the wind, especially whether onshore or offshore.

4. Ocean currents influence the distribution of rainfall. Warm currents increase precipitation on the neighboring coasts, for there is much water vapor over warm water, and this vapor is cooled when it moves inland, as on the eastern coasts of North and South America. Cold currents diminish precipitation, for the air is likely to be warmed and its humidity decreased as it moves over land, as on the western coasts of South America and south Africa.

5. Mountain systems influence precipitation by giving rise to ascending and descending air currents. Most mountain systems have a wet and a dry side, the wet side being toward the ocean or toward the prevailing winds. Outside of the tropics, the wettest parts of the world are mountain slopes facing prevailing winds from the oceans.

Seasonal variation of precipitation.—There are various types of seasonal distribution of rainfall, and these have great economic significance. There are large areas in equatorial regions where the rainfall is heavy throughout the year, and other areas within the tropics with alternate wet and dry seasons. In the middle latitudes, the west

coasts of continents have a winter maximum of rainfall, and dry summers. The origin of the precipitation is cyclonic, often accompanied by orographic factors. In the interiors there is a marked summer maximum, largely of thunder-storm type. On eastern coasts there is a fairly even distribution through the year, partly cyclonic and partly convectional, but usually with a summer maximum. The relation of rainfall to the growing season is of particular importance. For example, in a large portion of the Mississippi and Missouri Valleys, where the total precipitation is light to moderate, the heaviest rainfall occurs in the first half of the growing season, May, June, and July, when it is of the greatest value in the production of crops. A few types of monthly distribution of rainfall are shown in Fig. 95.

Annual number of rainy days.—The relation of the total rainfall to the number of days with rain is a climatic factor of some importance, indicative of the type of rainfall and

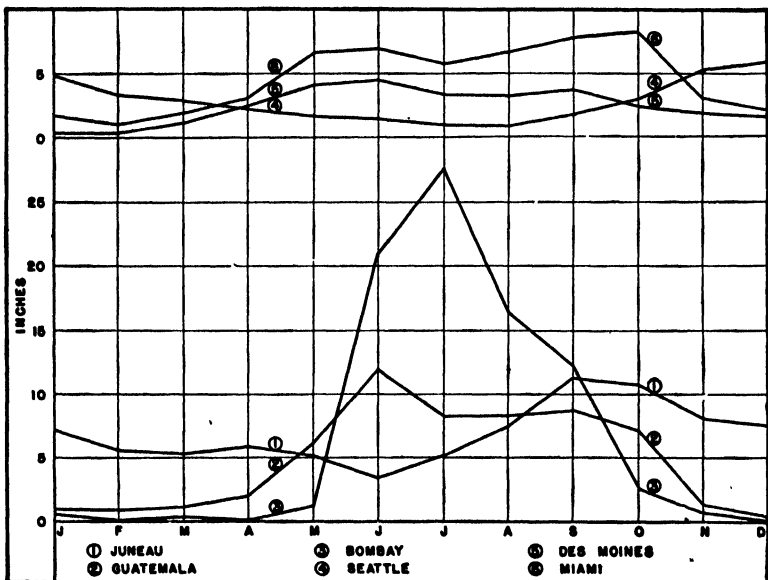

Fig. 95. Types of Rainfall Distribution by Months.

of the general impression of dampness or dryness given by the climate. In some places the rain falls in moderate or heavy showers of short duration, and the skies are clear for long intervals. These conditions are characteristic of the interiors of continents and of such regions as our Gulf and south Atlantic coasts. (See Fig. 96.) In other places there are many days of light rain or drizzle, giving a large number of rainy days but only light or moderate rainfall. In this country the coasts of Oregon and Washington have climates of this character, and in Europe the British Isles, the Netherlands, Belgium, and western France have similar conditions. In both continents, these are marine climates in the prevailing westerlies. The region around the Great Lakes has a similar climate in this respect. Seattle has 151 rainy days and a normal annual rainfall of 34.03 inches, giving an average of 0.23 inch per day of rain; Oklahoma City has nearly as much rain, 31.15 inches, but it falls on 82 days at the rate of 0.38 inch for each day of rain. Marquette, Michigan, has only 32.47 inches per year, but there are 165 days on which a measurable amount falls, each day on the average receiving only 0.20 inch; at Pensacola, Florida, a much heavier rainfall, 57.85 inches, occurs on many fewer days, 114, and the amount per day is 0.51 inch, or $2\frac{1}{2}$ times the amount at Marquette.

Areas of heavy and light rain.—The average annual precipitation is above 100 inches in small areas in Central America, Panama, western Colombia, and southern Chile; in the East Indies, the Himalayas, and along the north coast of the Gulf of Guinea. These are all warm regions, but profitable use cannot be made of the land, because the rainfall is too heavy, and the growth of native vegetation is too luxuriant. Average amounts between 80 and 100 inches occur at places on the west coast of North America from Alaska to Oregon, in tropical South America, many tropical islands, and large areas of the tropical oceans. At the other extreme, there are areas of less than 10 inches in southwestern United States, the Sahara and Arabian des-

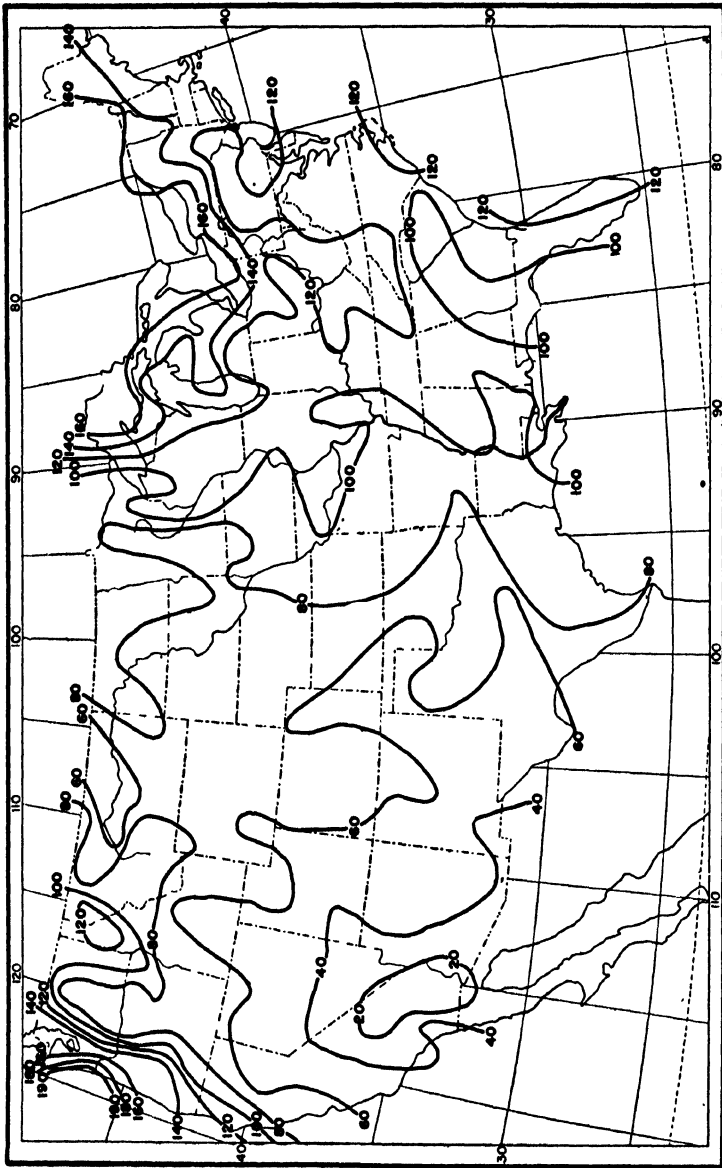

Fig. 96. Average Annual Number of Days with .01 Inch or More of Precipitation in the United States. Numerous local variations are not indicated.

erts, much of interior Asia from the Caspian Sea to China, the trade wind belts of the eastern Atlantic, and in north polar regions north of latitude 70°. In the Southern Hemisphere there are regions of less than 10 inches in South America, in southwest Africa, and in much of interior Australia.

Amounts of rain between 20 and 100 inches are favorable for agricultural use of the land. Areas receiving between 10 and 20 inches of rain a year are semiarid. They are suitable for grazing and dry farming, but not for intensive agriculture except under irrigation. Where the rainfall is below 10 inches, desert conditions exist, and water for irrigation must be brought from wetter regions. Production depends upon the yearly distribution of the rain, and other factors, notably temperature. The amounts, 10 to 20 inches, just given, are used as approximate dividing values. The following table shows approximate percentages of land areas of the earth with rainfall between given values:

DISTRIBUTION OF PRECIPITATION

Annual Rainfall in Inches	Percentage of Land Area	Climatic Classification
Less than 10	25	Arid
10-20	30	Semiarid
20-40	20	Subhumid
40-60	11	Humid
60-80	9	Humid
More than 80	5	Very wet

Some extremes of rainfall are: average annual precipitation at Cherra Punji, India (elevation 4309 ft.), 428 inches; at Mt. Waialeale, Kauai, Hawaii (elevation 5075 ft.), 451 inches, amount based on 24 years of somewhat imperfect record; at Glenora, Oregon, 131 inches. Precipitation extremes in a single month: Manoyuram, India, 264 inches; Helen Mine, California, 71 inches. Heavy falls in 24 hours: 46 inches at Baguio, Philippines; 23.22 inches at New Smyrna, Florida, October 9-10, 1924. In Roumania there

is a record of a fall of 8.07 inches in 20 minutes, and at Puerto Bello, Panama, a fall of 2.48 inches in 5 minutes. On the other hand, the average annual rainfall in inches is 1.33 at Helivan, Egypt; 1.45 at Greenland Ranch, Death Valley, California; 1.84 at Aden, Arabia; 4.16 at Arequipa, Peru; 5.39 at La Serena, Chile. There are considerable areas in southeastern California, western and southern Nevada, and extreme western Arizona where the rainfall is less than 5 inches a year.

Climatic Zones

A broad general classification of the climates of the globe may be made, following approximately a latitudinal division into zones. The zones include considerable climatic differences, but some characteristics applying to large areas may be mentioned.

Equatorial zone.—A simple and uniform climate is characteristic of the zone within the tropics. The central belt of this zone has a large annual rainfall and frequent and heavy thunderstorms in all months of the year. This is the region of dense tropical forests and underbrush of rapid growth. Bordering this wet belt on the north and on the south, there are regions which receive rain during the summer of either hemisphere, as the doldrums migrate toward the regions, but no rain during the winter months, when the doldrums are farthest away. In the Western Hemisphere these tropical areas with wet summers and dry winters extend northward into southern Mexico, and southward into Brazil. Toward the poleward sides of these belts, where the rainfall becomes light, there are open grasslands, or *savannas*, bordering the forests. The savannas include the Sudan of Africa, the Llanos of Venezuela, the Campos of Brazil, and the Downs of Australia. In the equatorial zone, seasonal temperature changes are slight. There are practically no seasons, except where there is a wet and a dry season. Temperatures average high throughout the year, and the climate is oppressive and enervating, especially

when the humidity is high, but maximum temperatures are usually not so high as in continental interiors in so-called temperate zones. In large areas of the tropics temperatures never reach 100°. High humidity, dense vegetative cover, and days that are shorter than summer days in higher latitudes, are factors in keeping the maximum temperatures moderate.

Subtropical zones.—The subtropical zones, one in each hemisphere, include the trade winds and the high pressure belts out of which they flow. In the trade wind belts, the winds blow with great regularity at a moderate velocity, storms are very rare, and temperatures are uniformly mild. The trade winds move from colder to warmer regions and are therefore rather dry even when moving over the oceans. Hence, skies are bright, sunshine is abundant, and there is very little rain except on the windward sides of mountains. Though not very stimulating, the climate is comfortable and healthful at all times, in marked contrast to the mugginess of equatorial climates. Ward states that the islands in the trade wind belts of the oceans, such as the Azores, Hawaii, and the islands of the south Pacific, have “the simplest and the most uniform climate in the world.” The belts of higher pressure are dry because of slowly settling air, but are subject to more variable winds and to occasional invasion by storms from the prevailing westerlies. Emphasizing the natural dryness of these belts, it may be noted that they embrace most of the great deserts of the world, including those in Africa, Asia, South America, and Australia. On the other hand, some of the greatest amounts of rain occur where high mountains intercept the constant trades, witness Mt. Waialeale, directly athwart the trades, with its 451 inches at an elevation of 5,075 feet. Only 15 miles away, near sea level in the lee of this mountain, the annual precipitation is about 22 inches.

Intermediate zones.—The middle zones of the earth are regions of the prevailing westerlies, much interrupted and confused by local conditions and by traveling disturbances.

Wide temperature ranges and marked changeableness of weather are striking characteristics. There is much variability of rainfall, which is generally heavier on the coasts and lighter in the interiors of the continents. On the equatorial sides of these zones there are transition areas which have a distinct type of climate, called *Mediterranean*. These areas are limited to the west coasts of the continents. They have mild temperatures throughout the year, with moderate rainfall in winter under the influence of the westerlies, and with dry, sunny summers under the influence of the subtropical belts of high pressure. The Mediterranean climate is of greatest extent in the region of the sea from which it is named, where it includes all the countries bordering on the Mediterranean in southern Europe and northern Africa and extends eastward to Persia. Mediterranean climates are found in other parts of the world, namely, on the west coast of South Africa, in southwestern Australia, and in California and northern Chile. The eastern coasts of the continents in corresponding latitudes have a more nearly continental type of climate, characterized by summer rainfall and greater annual temperature ranges. In India and on the eastern coast of Asia the Mediterranean climate is replaced by a monsoon climate. In Russia and Siberia, in middle latitudes, there are large, unwooded, grassy, semiarid plains called *steppes*. Similar regions in Hungary and in the Great Plains of the United States are said to have a *steppe climate*. This is a climate occurring in large continental interiors, in contrast to the Mediterranean climate, which occurs near the coasts.

Polar zones.—About 8 per cent of the earth's surface is included in the polar zones, in which only a minimum of plant and animal life exists. There is great insolation for a short time in summer, but since it falls on a snow or ice surface, there is little warming, and the ground is permanently frozen except in a thin surface layer. Precipitation is light.

Zones of temperature.—The earth may be divided into climatic zones by using isotherms instead of parallels of latitude. On this basis Supan has made the following divisions:

1. *Hot belt.*—the area inclosed by the mean annual isotherm of 68°F. This belt is irregular, mostly in the Northern Hemisphere, and somewhat larger than the torrid zone. The poleward boundaries represent approximately the limit of the trade winds and of the growth of palms.

2. *Cold caps.*—the area around the poles inclosed by the isotherm of 50°F. for the warmest month. This isotherm represents the limit of the growth of cereals and of forest trees. In cold regions it is the temperature of the summer rather than of the year that determines habitability and vegetative growth. Hence the temperature of the warmest month is used instead of the average annual temperature.

3. *Temperate belts.*—the area between the hot belts and the cold caps. The northern temperate belt extends north of the Arctic circle in Alaska and in Eurasia, but the cold cap extends south of the circle in the Bering Sea and on the Labrador coast. In the Southern Hemisphere the temperate belt reaches no farther south than latitude 55°.

For a more detailed study of climate, each of these belts may be divided into numerous subdivisions. Many such subdivisions have been made, both on the basis of temperature and amount and distribution of rainfall, and on the basis of plant growth.

Climate as Related to the Physical Features of the Earth's Surface

The differences of climate so far discussed have been closely related to distance from the equator, but there are climatic variations wholly independent of latitude. The elevation of an area and its position relative to continents, oceans, and mountain systems give the area certain climatic characteristics in whatever part of the world it may be.

Other factors, indirectly related to latitude, but producing independent effects on climate, are the influence of prevailing winds, of ocean currents, and of the prevalence of cyclonic storms.

Continental climates.—In the interiors of continents the climate is usually rather dry and clear, that is, rainfall is light to moderate, relative humidity is low, and sunshine abundant. Within the tropics temperature contrasts are small over large land areas as well as over the oceans. In middle latitudes continental climates are marked by severe winters and hot summers; in polar regions the winters are long and severe, and the summers short and cool. Steppe climates are dry continental, and a desert is an extreme type of dry, hot, continental climate.

Marine climates.—The climate of the oceans and of lands that are largely influenced by ocean conditions, islands, for instance, is characterized by small daily and yearly ranges of temperature, with nights and winters relatively warm, days and summers cool. That is to say, these climates are equable and moderate in their changes. Because water warms slowly, the springs are late and cool; because it cools slowly, the autumns are late and warm. In the interior of the United States July is the hottest month, on the average; at San Francisco, where the climate is largely marine, September is the warmest month. Except in the trade wind belts, marine climates usually have greater humidity and cloudiness than continental climates.

Coastal or littoral climates.—The climate along the coasts of continents is intermediate between the marine and the continental types. The prevailing winds and mountain barriers largely determine the distance inland to which oceanic influences penetrate. In the zones of the prevailing westerly winds, west coasts of continents have belts of distinctly coastal climate, but on the east coasts, continental climates extend practically to the shore. In trade wind belts east coasts are under marine influence, and west coasts under continental influence. Oceanic and conti-

mental influences on temperature are exemplified by the following table of January and July mean temperatures across northern North America from west to east:

Station	Latitude	Longitude	Mean Temperature °F.	
	North	West	Jan.	July
Prince Rupert	54° 10'	130° 6'	35.0	56.0
Edmonton	53° 33'	113° 30'	5.5	61.1
Prince Albert	53° 10'	105° 38'	-4.7	62.7
Winnipeg	49° 53'	97° 7'	-3.9	66.4
Ft. Hope	51° 33'	87° 49'	-7.9	62.2
Moose Factory	51° 16'	80° 56'	-4.8	61.5
Southwest Point . .	49° 23'	63° 43'	12.2	56.7
St. Johns	47° 34'	52° 42'	23.6	59.3

Mountain and plateau climates.—On mountains and plateaus the average temperature decreases with elevation, at a rate approximating that of the average lapse rate in the free air, but with many local variations. The rainfall increases up to 6,000 or 7,000 feet and then decreases because of reduced absolute humidity. As the air becomes thinner and freer of dust and moisture, it absorbs less radiation, and insolation is, therefore, more intense by day, and radiation-cooling more rapid by night. However, where there is considerable slope, the daily temperature ranges are kept relatively small by the thorough mixing of the air. By day, warmed air readily ascends the slopes, partly because it is pushed up by cooler air which comes from the free air some distance away and is therefore not warmed by contact, and partly because expansion of the deeper column of air over the valley results in increased pressure at upper levels and a pressure gradient toward the slope. By night, the cool air drains down the slopes and is similarly replaced by warmer air. Thus mixing is facilitated.

On large, level plateaus, on the other hand, where there is no aid to the mixing of the air, both daily and annual ranges are larger than in lowlands similarly situated. In mountain climates, one is readily warmed in the sunshine by absorption of the intense insolation, while the air itself, which absorbs little radiation, remains cool. At elevations

of 12,000 to 15,000 feet the air becomes so rarefied as to cause mountain sickness in many persons, because of insufficient oxygen. Mountain ranges interfere with the free movement of the lower air and often act as climatic divides or barriers, resulting in quite different climates on opposite sides. For example, the west portions of Oregon and Washington have a wet and largely marine climate, while east of the Cascade Range the rainfall is light and the climate typically continental. The Alps are a barrier separating the climate of central Europe from that of the Mediterranean coast.

Major climatic influences.—The more important influences governing the climate of a region and some localities in which each is a prominent factor may be listed as follows:

1. *Latitude.*—Greenland, tropical South America.
2. *Position relative to land and water.*—Seattle, Kansas, Hawaii.
3. *Altitude.*—Denver, Alps valleys.
4. *Position relative to mountain barriers.*—Nevada, eastern Colorado, Riviera.
5. *Prevalence of cyclonic storms.*—New England, the region of the Great Lakes.
6. *Prevailing winds.*—Hawaii, India, Azores.
7. *Ocean currents.*—Norway, Labrador.

Cyclical Changes of Weather and Climate

A cycle is the interval of time in which a certain succession of events is completed, and in which it repeats itself again and again in the same order. A cyclical, or periodic, event is one that recurs at regular, equal intervals. There are two very evident weather cycles of such importance that we base our reckoning of time upon them, namely, the daily and the annual cycles. It may be noted, however, that as weather periods, neither of these is absolutely regular in its recurrence. The diurnal period in the weather is governed by the times of sunrise and sunset and is, accordingly, vari-

able in length, except at the equator, and altogether ceases to exist as a 24-hour cycle in polar regions. The annual period in the weather is also of variable length, for the seasons are sometimes "late" and sometimes "early."

Weather cycles.—A brief examination of a climatic table of rainfall shows that a few dry years often occur in succession, followed by a series of wet years, and again by another group of dry years. Such short period fluctuations are constantly occurring, not in precipitation records alone, but also in connection with other weather elements. It is these variations, and not the daily and yearly periods, that are commonly called *weather cycles*. There can be no doubt of the existence of the fluctuations, but none is truly periodic in its recurrence. Much attention has been given to the statistical analysis of weather data in the hope of finding periodicities that would be useful as indicators of future conditions, and a great many so-called cycles have been found in this way. There is a list of more than 100 of these, varying in length from 8 months to 260 years, but they all show irregularities: successive recurrences are of different length and intensity; the cycles are interrupted by departures in the opposite direction; after persisting for several periods, a cycle may suddenly fail, sometimes to begin again later in a different phase. There are so many of these "cycles," and they are so irregular, that the result can hardly be distinguished from chance. They have not proven of practical value in forecasting next year's weather.

The best known of these periodicities are the *Bruckner thirty-five-year cycle* and the *eleven-year cycle*. The latter is related to the occurrence of sunspots. Using European data, the Swiss professor, E. Bruckner, found that relatively warm and dry years tend to alternate with relatively cool and wet years in a period averaging about 35 years in length; the variation in precipitation amounting to about 20 per cent. Evidences of this cycle have been found in data from all parts of the world, not only in the numerical data of the past 100 years, but in earlier records of lake levels, dates of

grape harvest, the growth rings of trees, and such other indications of weather conditions before the beginning of systematic weather records. The record used by Bruckner extended from 1020 to 1890, and gave an average length of period of 34.8 years, but individual oscillations varied from 20 to 50 years. This variation in length, combined with the occurrence of local exceptions and temporary reversals, renders the indications of the Bruckner cycle uncertain. It is, however, broadly applicable over a wide range of data, and is generally accepted as representing some reality, though no reason is known for the existence of such a period in the earth's weather.

The number of sunspots increases and diminishes in a cycle of about 11 years, from one maximum or minimum to the next, attended by changes in the solar output of radiant energy. There are many indications that these changes influence the weather of the earth, but the effects are small and difficult to follow. There are evidences of this period or of the double period of about 22 years and 8 months in many weather records and in such records as the thickness of tree rings and of clay layers deposited by glaciers. In this case also, the periods are of varying length, and the weather responses are changeable in amount and are often obscured by other fluctuations.

Weather cycles, in the sense of fluctuations of an irregular nature, are characteristic of climate throughout the world and often have important social and economic consequences. For example, in the plains of western Kansas, western Oklahoma, and eastern Colorado, there have been series of wet years with accompanying good crops and good prices for land, and series of dry years, causing crop failures and land abandonment. Cycles of this kind are illustrated in Fig. 97, which shows first the actual rainfall record for the state of Iowa for the years, 1873 to 1934, and second, a method of charting the data of rainfall to give a clear picture of cyclical changes.

In the upper curve the annual total of rainfall is indi-

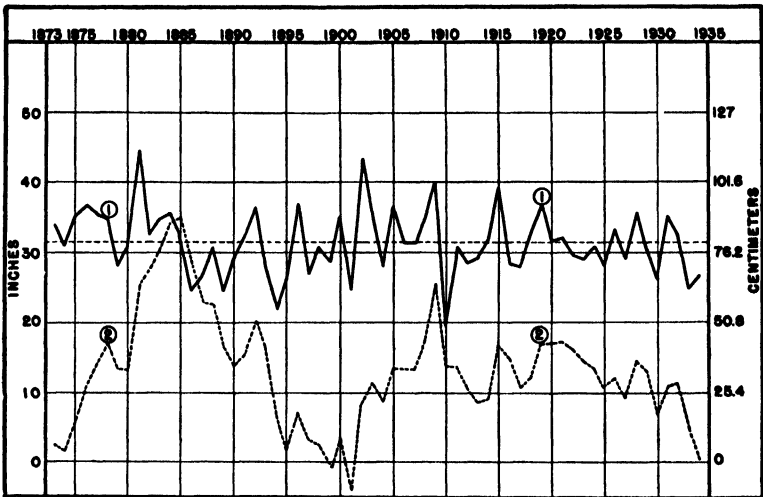

Fig. 97. Iowa Precipitation, 1873-1934. 1, actual precipitation by years; normal 31.60 inches. 2, accumulated sums of departures from normal.

cated year by year by the distance of a point above the zero line of the figure, and these points are connected by a broken line. A straight line of dashes indicates the average value. Amounts above and below normal occur very irregularly, and cycles are not very evident in this curve. In some cases a few wet or dry years occur in succession; at other times there are frequent alternations between wet and dry years. The wettest year of the record, 1881, is preceded by two dry years and the driest year, 1910, is preceded by two moderately wet years. In the lower curve the method of *accumulated sums of departures* is used. The departure of the rainfall of each year from the average of the entire series is first obtained, and then, beginning with the first year, the year by year accumulated algebraic sums of these departures are calculated and entered. In a series of wet years there is an accumulating excess of precipitation, and the line moves upward; in dry years it moves downward. The line slopes up when the year is wet, and down when it is dry, without reference to its position relative to the zero line. This curve makes certain cyclical tendencies evident.

It shows that there was an increasing accumulation of rainfall above normal for 11 years from 1874 to 1885, then a declining rainfall with some interruptions for 16 years to 1901. There followed a rapid rise for 9 years with one slight setback. Since 1909 the curve has been irregular, with brief periods of excess and deficiency but with an unmistakable downward trend, especially near the end of the record. Such imperfectly cyclical variations as are shown by this figure are typical of weather records in general.

The recent period of declining precipitation shown in the Iowa record is emphasized by the occurrence of 3 severe and extensive droughts in central and eastern United States. These occurred in 1930, 1934, and 1936. In 1930, the spring months, March, April, and May, were drier than normal in all but 2 states east of the Rocky Mountains, and 5 states, Missouri, Illinois, Indiana, Kentucky, and West Virginia had the driest spring of record, with an average precipitation of only 57 per cent of normal. The deficiency continued and increased during the summer (as shown in Fig. 98), when 7 states had the lowest summer rainfall of record, and more than half of the country was decidedly drier than normal. The droughty condition was largely relieved during September.

The spring of 1934 marked the beginning of another and even more intense drought. Precipitation was much below normal from March to August, inclusive, over about half of the United States. The deficiency was especially great during the spring months and was then the most widespread in the climatological history of the country. Seven states in the Mississippi and Missouri Valleys received the least spring precipitation of record, as shown in Fig. 99, averaging only 40 per cent of normal. The drought continued during the summer months over the central portion of the country, with somewhat diminished intensity as to rainfall but with very high temperatures. Considering the entire United States, July, 1934, was the hottest month ever known up to that time, with the all-time maximum

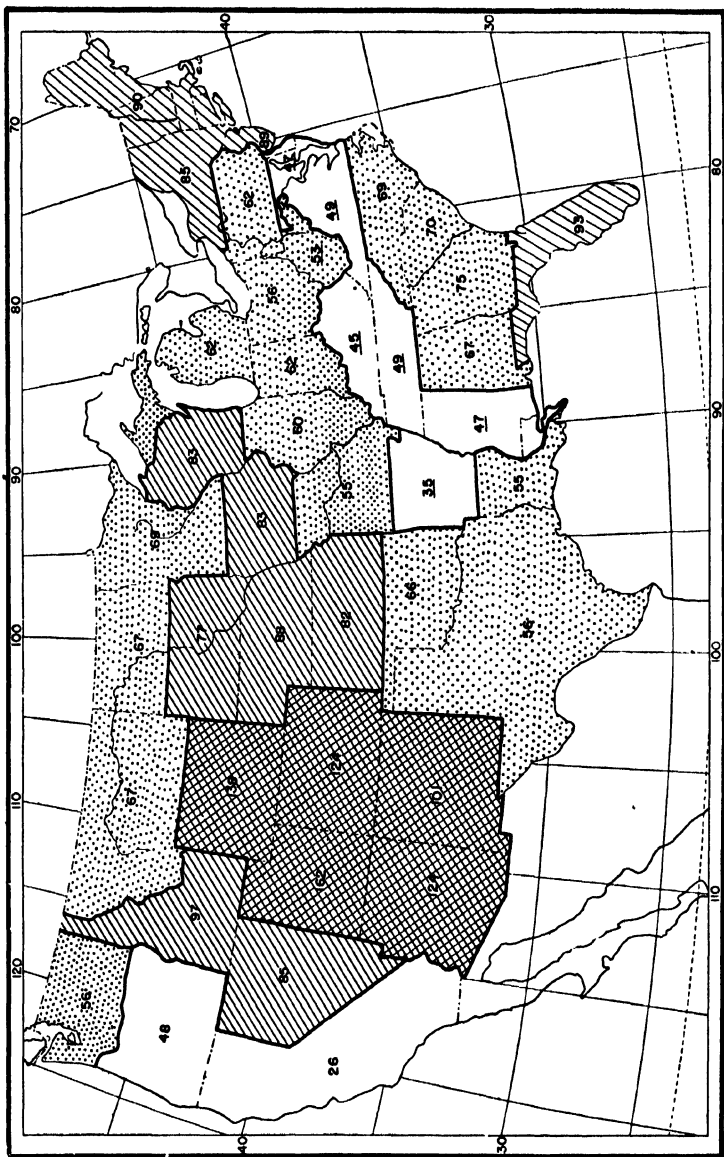

Fig. 98. Summer of 1930; Percentage of Normal Precipitation by States. Underlined percentages are the lowest $\frac{1}{2}$ record. (After *Weekly Weather and Crop Bulletin*, U. S. Weather Bureau.)

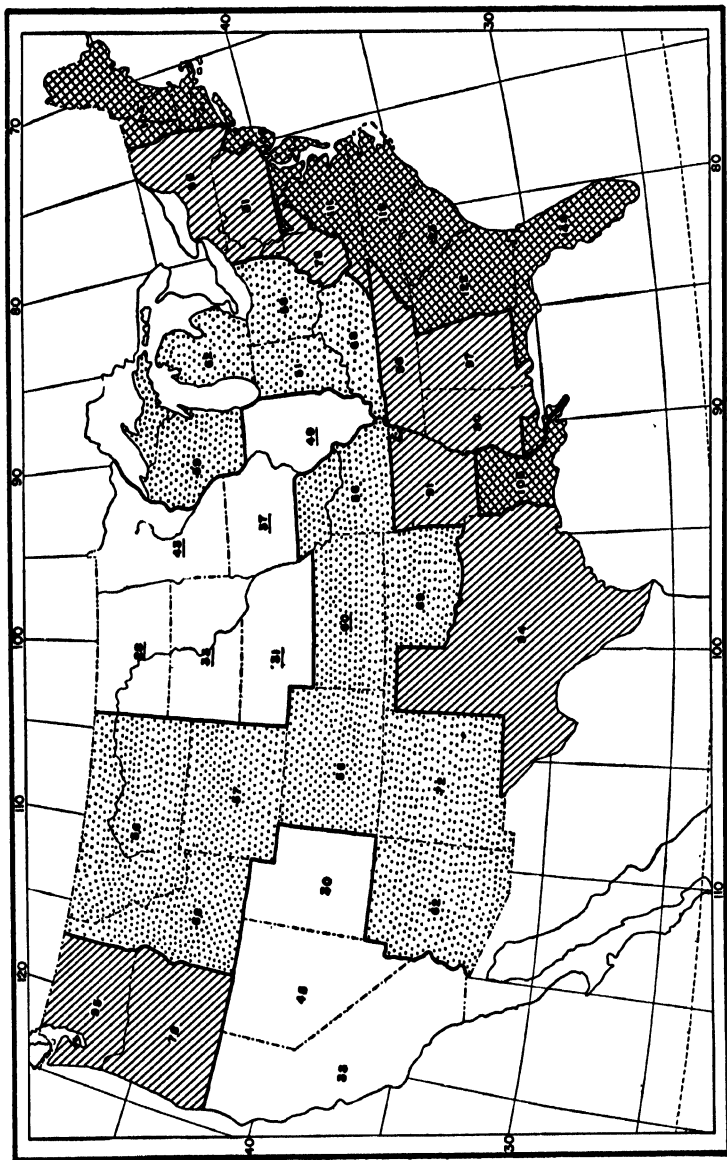

Fig. 99. Spring of 1934; Percentage of Normal Precipitation by States. Underlined percentages are the lowest of record. (After *Weekly Weather and Crop Bulletin*, U. S. Weather Bureau.)

temperature records exceeded in many places, especially in the Middle West. There was a definite change in the type of weather in late August, and the new type continued during September, which was cool and wet over a large part of the area where the heat and lack of moisture had been most pronounced.

After one year of moderate rainfall, the third drought of this series began early in 1936 in the southeastern states, where great harm resulted to early crops, especially from North Carolina to central Alabama. By early summer the drought had become severe in the Middle West. It continued severe, attended by extreme heat, through July, in the states north of the Ohio River and in the region between the Mississippi River and the Rocky Mountains. In much of this area June and July were the driest of record and much drier than the same months of 1934, and July was the hottest month of record over a large area, surpassing the heat of 1934. Northern and eastern portions of these areas fared somewhat better during August, but the severe conditions continued without abatement in most of the Missouri Valley and the Great Plains, until the closing days of August. It will be noted that the drought began in the east and progressed westward as the summer advanced. It resulted in a major disaster to the corn crop in the Middle West. The summer rainfall, expressed in percentages of the normal amounts, is shown in Fig. 100 by states.

The occurrence at brief intervals of these three extremely dry years, with only moderate precipitation in the intervening years, leaves no doubt that the United States east of the Rocky Mountains was in a very dry phase of a rainfall cycle. A previous dry phase in United States climate, comparable to this, just as severe in some areas but not so extensive, prevailed from 1886 to 1895. In the interval between these dry periods, that is, from 1896 to 1929, there were occasional dry years and droughts in limited areas, but for the central and eastern United States as a whole, precipitation averaged above normal, especially from 1900

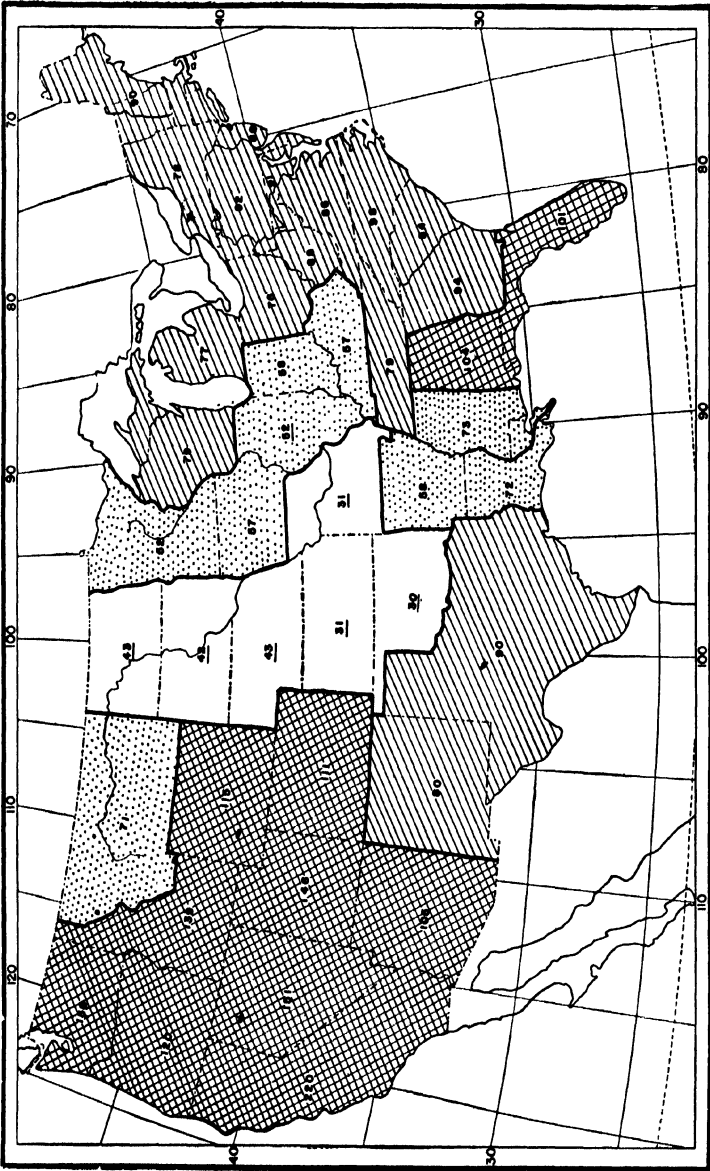

Fig. 100. Summer of 1936; Percentage of Normal Precipitation by States. Underlined percentages are the lowest of record. (After *Weekly Weather and Crop Bulletin*, U. S. Weather Bureau.)

to 1920. Just previous to the dry period of 1886 to 1895, a decidedly wet phase of the cycle was in evidence, lasting for about 20 years, from 1865 to 1885. This wave-like up-and-down movement of the rainfall over periods of a few decades is to be regarded as the natural, normal behavior of the climate, and any long-time planning should take account of these variations. Unfortunately, planning is hampered by the irregular nature of the variations.

Secular trends.—In addition to the short period variations commonly meant by the term *weather cycles*, there are tendencies that persist over longer periods and are known as *secular trends*. In Fig. 101, taken from J. B. Kincer, long-time temperature trends at New Haven, Connecticut, and Copenhagen, Denmark, are shown, by means of 20-year moving sums. The value entered on the graph for each year is the sum of the mean annual temperatures for the 20 years ending at the year indicated. Thus, the New Haven record began in 1780, but the first point on the curve is for the year 1799, and the value is the sum of the temperatures from 1780 to 1799, inclusive. The next value, entered at 1800, is the sum for the years

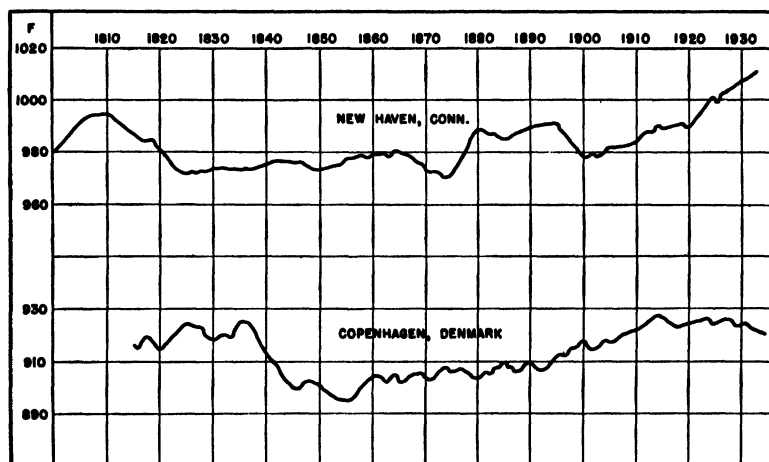

Fig. 101. Secular Trends of Temperature, 1800-1933, Shown by 20-year Moving Temperature Summations. (From J. B. Kincer.)

1781-1800, inclusive, and so on, year by year, for the entire record. This method of plotting the data largely eliminates the annual fluctuations and the short period weather cycles, such as are shown in Fig. 97 for Iowa rainfall, and emphasizes the tendencies that persist for more than 20 years.

The New Haven curve reaches a peak in 1811 and then trends downward until 1875, a period of 64 years, declining rapidly at first and then more slowly. From 1875 to the end of the record, the general trend is upward, but with some important interruptions persisting for a few years. The upward trend had persisted for 57 years at the close of the record. The curve is below the average value continuously for the 58 years from 1820 to 1878, and mostly above the average since the latter date. At Copenhagen a sharp decline in the curve begins in 1837 and continues for 20 years. The values then move irregularly upward for a period of 59 years, reaching a peak in 1915. Since then the trend has been slightly downward. The time from maximum to maximum in the Copenhagen curve is 79 years. At New Haven the length of the wave, beginning with the crest of 1811, is already 121 years, and there is no indication that another crest has yet been reached. The upward swing in temperature began about 20 years earlier at Copenhagen, and presumably in northern Europe, than in the New England states. Kincer finds that similar rises, persisting for at least 50 years, have occurred generally in central and eastern portions of the United States, and that the rise has been greatest in fall and winter. The summer months show little increase in average temperature. Thus a common impression that the winters are less severe than formerly receives some confirmation. No cycles of definite length are disclosed by these curves, but the trends are long enough and large enough to be of considerable significance in the life of an individual.

There are many evidences of still longer secular trends in climate. In studying the annual growth rings of sequoias, A. E. Douglass found evidence of oscillations in

periods of a few centuries in addition to those of a few years. Periods of a similar order of length have been found in the study of glaciers and of lake levels in Europe and Asia. There is some evidence that Persia and Turkestan, Arizona and New Mexico are drier than they were at the beginning of the Christian era, and that Yucatan and southern Mexico are wetter. If these conclusions are correct, it seems probable that the changes indicated are trends or cycles of a still greater length. However, in most parts of the world there is no evidence of important trends persisting through centuries.

When we extend our time scale and think in terms of geological epochs, we find that climate has changed greatly, but also cyclically, alternating between glacial and interglacial periods. At one time glaciers covered large areas of northern United States; at another time some of these areas were covered by dense tropical forests and inhabited by huge tropical beasts. Plant seeds and spores preserved in peat bogs are now interpreted as giving evidence of several long climatic trends since the glaciers disappeared, periods of perhaps a thousand dry years and then a thousand wet. The fact that great climatic changes have occurred in geologic time is undisputed, but the causes of the changes are still a subject of speculation. It is certain that alterations in the elevation of the land and in the distribution of land and water have resulted in great changes in climate, but whether or not there were other causes of the geological climatic fluctuations is not known. It seems probable that such slow changes in climate are still in progress, as slow changes in the elevation and distribution of land undoubtedly are.

We conclude that there are very numerous oscillations in the atmosphere, some short and some very long, and that therefore it is not possible to obtain an absolutely stable "normal" value of the weather elements. The oscillations resemble cycles but are not truly periodic; they resemble the movements of a pendulum except that the weather does

not keep time in its vibrations as a pendulum does. No physical explanation of the origin and continuance of these oscillations is known. They may be the result of variable outside influences, particularly insolation, or they may be due to natural periods of vibration in the atmosphere itself. They are so numerous, so variable and inconstant that thus far it has not been found safe to trust their extension into the future. They can certainly not be depended on to indicate next year's weather, nor is it possible to foresee when the general trend will alter its direction.

Climatic Controls

The terrestrial conditions governing the climate of a given portion of the earth have previously been discussed. In connection with the consideration of climatic variability, it is important to examine the larger factors that determine the climate of the earth as a whole, and whether or not they are subject to slow or sudden changes. The four major factors controlling the climate of the world are: (1) the output of solar energy, (2) the earth's distance from the sun and its position relative to the sun, (3) the extent, composition, and dust content of the atmosphere, (4) the elevation of land and the distribution of land and water.

Insolation.—As previously noted, the output of solar energy has small, irregular variations from day to day and in an 11-year period. There is some evidence, not wholly conclusive, that these variations influence weather changes and short climatic fluctuations. Other changes in solar energy may have occurred, and may still be in progress. They may have modified the climate of past ages, but no evidence of such changes exists. In particular, there is no reason to suppose that *sudden* changes of climatic significance have occurred.

Relative position of earth and sun.—Aside from the regular seasonal variations in the position of the earth's axis relative to the sun and in the earth's distance from the sun, these undergo slow and slight changes in periods of 21,000 to

400,000 years. One theory of the cause of glacial and interglacial epochs, Croll's theory, is based upon these recurring slight changes in the earth's orbit. The theory is open to serious objection as an explanation of the known glacial history, and in any case, such changes as have occurred within the past few thousand years have had no appreciable effect on climate.

Atmospheric content.—The extent and gaseous composition of the air, by affecting the amount of absorption of incoming or outgoing radiation, affect the climate of the world. Another theory of the cause of the ice ages is based on supposed variable amounts of carbon dioxide in the air in different eras, and the fact that this gas is a good absorber of earth radiation. This theory is not generally accepted, and it appears certain that the proportion of the gases of the air has remained practically constant since the beginning of history, although it probably changed appreciably in geological epochs. During past geologic ages there were probably periods of great volcanic activity during which immense quantities of dust were thrown into the air. This volcanic dust, by intercepting much solar radiation, may have been an important factor in the production of climatic changes and, according to Humphreys, was probably one of the chief causes of glaciation. There is observational evidence that large volcanic eruptions in historical times, such as those of Krakatoa in 1883 and Katmai in 1912, have been followed by cooler weather for a year or two. These slight temporary results have been observed, but the variation in the amount of volcanic activity in the past few thousand years has not been sufficient to effect a persistent change in climate.

Distribution and elevation of land.—Finally, great changes in the elevation of large land areas, in the extent of the land surface, and in the distribution of land and water have undoubtedly caused great alterations in the climates of the world in the past million years. There are evidences of the alternate uplift and subsidence of large

land masses, resulting in great variations in the elevation of the land and also in the ratio of the total land surface of the globe to the water surface. We know that elevation has important effects on climate, and we know that changes in the extent and position of land areas would greatly modify climate, not only because of the different responses of land and water to insolation, but also indirectly by producing changes in ocean currents and atmospheric circulation. It seems clear then that these terrestrial changes have been important factors in past climatic pulsations, but the changes are slow in terms of man's history, and such slight changes as have occurred in historical times have had no observable effect.

Stability of historic climate.—We may disregard geological epochs, because they are too long to be included in the ordinary, everyday meaning of climate, and we may disregard weather cycles as too short and consider climate to mean the summation of weather conditions within the recorded life of man. In this sense climate is about as stable as anything we know on earth, about as permanent as the hills. While there is some evidence in Asia and in our southwest of changes in the past 1,000 or 2,000 years, in most parts of the world the evidence is to the contrary. Olives are still grown in Palestine and silkworms in China, under apparently the same climatic conditions as prevailed several thousand years ago. In spite of weather cycles and secular trends, the climates of the world appear not to have changed progressively in one direction within the period of history.

There are no sudden, violent changes of climate. That is the conclusion to be drawn from our knowledge of the past, and it is also the conclusion when we consider the causes of climate, that is, the climatic controls discussed in the preceding paragraphs. While all of these factors are more or less variable in the slow course of time and may have been influential in producing geological changes of climate, we have no reason to suppose that any of them

ever has or ever will change suddenly nor appreciably, within a few hundred nor a few thousand years. We may therefore expect the climates of the world to remain relatively stable in terms of human history.

Further, it is evident that the activities of man cannot influence these major controls of climate. We cannot yet analyze all the forces affecting weather and climate nor explain their periodic fluctuations, but both reason and experience indicate that climate is much more stable than human institutions or relations. The climatic factors, affecting profoundly the economic, social, and physical life of man, remain comparatively permanent in a changing world. Nations rise and fall, causing changes in trade routes, the rise of new commercial cities, and the decline of old ones. Scientific discoveries and their applications lead to new industries and new habits with resulting changes in economic life and the distribution of the population. Climate, however, remains a practically constant element of man's environment.

Summary

The effects on plant and animal life and on man's activities produced by a given climate depend on a great many factors and a great variety of combinations of these factors. Hence, to describe a climate in detail requires the classification and tabulation of much data. In addition to tables of averages of all the important weather elements, there must be tabulations of various kinds showing their variability and their extreme values.

A map of the distribution of the average annual temperature over the earth clearly shows the primary control exercised by the sun, and it also reveals important deviations from that control. The isotherms indicate their partial independence of insolation by crossing latitudinal lines and bending poleward or equatorward in response mainly to the position and extent of land and water surfaces, and to the transfer of heat by winds and ocean

currents. The seasonal change of temperature is also obviously solar in its origin but is modified by the same other factors, resulting in cold continents and relatively warm oceans in winter, and hot continents and cool oceans in summer. This implies also greater seasonal migrations of the isotherms and greater annual ranges over the continents than over the oceans. Daily ranges of temperature, likewise, are greater over land than over water. Daily ranges decrease with increased humidity of the air and increase with increased elevation of the land.

The distribution of precipitation is even more irregular than that of temperature. In general, the rainfall decreases from equatorial to polar regions and from coastal areas to the interiors of continents. In addition, its distribution is influenced by the prevailing winds, by ocean currents, and by mountain systems. There are various types of seasonal distribution of precipitation. In regions of moderate rainfall a maximum of rain during the early part of the growing season is most favorable to the production of crops. The climate of a region where the rainfall occurs in moderately heavy amounts on relatively few days, with much sunshine between, is quite different from that of another region where the total precipitation is the same, but where it falls slowly over long periods with long-continued cloudiness.

Broadly speaking, the climate of the equatorial zone is simple and uniform as to temperature, with a central belt of heavy rain throughout the year, and bordering belts having wet and dry seasons. Subtropical and Mediterranean zones have mild, pleasant, arid, or semiarid climates. The intermediate zones are areas of traveling barometric disturbances, changeable winds, and much variability of temperature and rainfall. In polar zones precipitation is light, and temperatures are too low to permit much life. For climatic purposes it is better to use the mean annual isotherm of 68°F. instead of the Tropics of Capricorn and Cancer to separate equatorial and intermediate zones, and

to use the isotherm of 50°F. for the warmest month as the poleward limit of the intermediate zones.

Independently of latitude, continental climates, except in equatorial regions, are typically dry, sunny, and radical in temperature changes; and marine climates are typically moist, moderate, and equable. Coastal climates are intermediate between continental and marine climates. In elevated regions the air is thin, dry, and of small dust content; insolation is intense by day, and radiation active by night; daily ranges of temperature are large except where drainage and mixing occur. Summarizing solar and terrestrial influences, it may be said that *astronomy sketches the main outlines of climate, and geography fills in the details.*

Weather and climate are characteristically fluctuating in their nature. Climatic data throughout the world show this tendency to oscillate above and below average values in periods varying in length from a few years to many years. Variations of this character are usually shown by plotting successive moving sums or means of actual data, or by plotting the accumulated algebraic sums of departures from the average. Rainfall data, when thus plotted, often show alternating series of wet and dry years, the length of the cycles varying from 2 or 3 up to about 35 years. Temperature data show similar pulsations. Longer tendencies in one direction are sometimes found and are usually called *secular trends*. Extending our consideration still further back, there is no doubt that great and alternating slow climatic changes have occurred in past geologic ages, with periods hundreds of thousands of years in length, and such changes are probably still in progress.

In subhumid and semiarid regions rainfall fluctuations of a few years' duration are often of great practical significance; in the series of wet years the land is productive and valuable, but in the dry years agriculture becomes unprofitable. It is characteristic of these "cycles," of whatever length, that they do not repeat themselves with accuracy. It has, therefore, not been found safe to base

predictions of future weather upon any of these cycles.

The general climatic conditions of the world are determined by four major influences: (1) solar radiation, (2) distance from sun, and inclination of earth's axis, (3) composition and mass of the earth's atmosphere, (4) position and elevation of land areas. All of these are wholly independent of man and his activities. They have all varied in past geological history, but with extreme slowness in terms of human history. None of them has varied significantly in historical times, and, consequently, the general character of the climate has remained unaltered.

In spite of minor fluctuations of a few years' length and long trends in terms of geological epochs, climate, when considered as the summation of weather conditions in historical times, appears to be essentially stable. Nations and individuals may plan their future with a dependence on the fixed character of climate, including its characteristic pulsations.

Problems

1. On 3 outline maps of the world draw the isotherms for the year, for January, and for July.
2. On each of these maps draw the "heat equator" through the middle of the hottest belt.
3. Why do higher maximum temperatures occur in North Dakota than in Alabama?
4. Indicate the normal annual precipitation on a map of the world by different colors or shades for intervals of 10 inches.
5. Why do continental interiors have their maximum precipitation in summer?
6. Obtain a local *Annual Meteorological Summary* as published at many Weather Bureau stations, and list the various items of climatic information published therein.
7. Plot records of temperature and rainfall, using accumulated sums of departures and also 20-year moving sums, and report on the character of the variations indicated.
8. Write a brief description of the climate of your state.
9. Is the climate of your state changing?

CHAPTER XIII

Climate and Man

Climate is one of the fundamental factors conditioning the life of man on the earth, and to discuss all phases of man's response to his climatic environment would be to treat of the whole of man's life itself. Attention will be called in this chapter, briefly, to four of the important relations of weather and climate to the life and labors of man. Others have been referred to incidentally in previous chapters.

Weather and Health

Every one feels the bodily and mental influence of the weather. Many persons are depressed and discouraged on dark days, or nervous and irritable on windy days, and others feel the changes in atmospheric conditions in twinges of rheumatism, neuralgia, or old wounds. Poets of all ages have responded to the stimulus of spring. Temperature, relative humidity, wind, and sunshine are the four weather elements that most directly affect man's physical condition.

Temperature and health.—A number of investigations have indicated that the most favorable temperature for persons engaged in active work either indoors or outdoors is about 64°. although it differs somewhat for different individuals. More work will be done with less fatigue at about this average temperature than when it is either warmer or colder. However, frequent moderate changes in temperature are stimulating, especially changes to cooler weather. Autumn, with moderate temperatures changing to cooler, is more favorable than spring with its increasing

warmth. Long cold spells and long hot spells are alike depressing. The duration of the extreme temperature is very significant. One very hot day in summer can be endured, but with each successive day of extreme heat, the output of work decreases, the vitality is lowered, and the death rate increases. The same is true of continued very cold weather. Vital statistics indicate that the death rate is lowest when the mean daily temperature is between 60°F. and 75°F. Some diseases are directly limited by temperature conditions. Malaria, yellow fever, and other diseases do not occur in cold weather.

Humidity, air movement, and health.—Air of moderate humidity is both more comfortable and more healthful than very dry or very moist air. Relative humidity is connected with temperature in its effects on the bodily functions. High humidity with high air temperature increases conduction of heat to the body and at the same time retards evaporation. Hence the body does not cool readily, and the heat is oppressive. High humidity in cold weather increases the conduction of heat from the body at a time when we need to conserve it and intensifies the feeling of cold. High humidity makes us feel warmer in hot weather and colder in cold weather.

With the occurrence of the high temperatures of summer in continental climates, especially in connection with tropical marine air, humidity is often so great as to become an unfavorable health factor. Under these conditions there is little cooling of the skin, and the mechanism of the body is subjected to a strain to keep its temperature normal. The death rate, especially among infants, reaches excessive proportions, when a high humidity coincides with a high temperature. On the other hand, humidities may also be too low in hot weather, causing the skin and mucous membranes to parch and crack, especially if the hot weather is attended by moderate or high winds. The "hot winds" of the Great Plains are uncomfortably dry at times, and "*simoons*," the hot, dry winds of the African and Asian

deserts, are sometimes fatal even to persons in vigorous health. When these winds blow, there is rapid perspiration and evaporation from the skin. The rate of perspiring has a definite physiological limit, however, and these winds with temperatures well above that of the human body may convey more heat to the body than can be dissipated by evaporation. There is a net gain of heat above the natural blood heat, with resulting fever and death. Similarly, the "hot winds" of the Great Plains cause a wilting and "burning" of the corn fields by overtaxing the moisture-carrying capacity of the plants.

Humidity is especially related to the respiratory diseases, such as pneumonia, influenza, and bronchitis. These are more prevalent in winter, owing probably not so much to low temperatures as to the low humidities existing in our homes, offices, and even hospitals in cold weather, and to the spreading of infections, facilitated by indoor living. Taking in outside air at zero and warming it to 70° without supplying a large amount of water, makes it drier than the winds of Sahara and puts an undue strain upon the skin and the mucous membranes of the air passages.

The bad effects of air in crowded rooms are caused not by carbon dioxide or other impurities, except disease germs, but by heat, low humidity, and lack of movement. For comfort and health, homes and hospitals should have gently moving air. Just as very cold and very hot weather are unfavorable for vigorous health, so also are extreme humidity conditions in either direction. The same is true of winds. Both high winds and quiet air intensify certain bad effects of other unfavorable conditions. Gently moving air is most favorable. The temperature felt by the body, the effective temperature, is determined by the three conditions, air temperature, relative humidity, and air movement. These three elements determine the "cooling power of the air."

Sunshine and health.—One other element, sunshine, is generally recognized as of great importance for health.

The healing, disinfecting action of sunlight has long been known empirically, and modern medical science has fully confirmed its value, emphasizing especially the action of the ultra-violet portion of the sun's spectrum. Exposure of tubercle bacilli to the direct rays of the sun renders them innocuous within an hour, while they will live in diffuse light for 6 to 24 hours and in dark places for 2 to 18 months. All health resorts have a high percentage of sunshine. A certain moderate intensity of sunshine is as essential to human and animal life as it is to plant life.

Ideal weather.—There are extremely few diseases directly caused by weather or climate, but the condition of the atmosphere in which man lives often influences profoundly his vitality and his susceptibility to infection. Certain states of the weather are bracing and others relaxing. Some air conditions are an aid to health and activity; some are a hindrance. Hot, humid, tropical climates appear to be the most unfavorable, and white men cannot live for long periods in such climates, without a general lowering of energy and of ability to resist disease.

The same conditions are not ideal for all persons in all states of health. Sometimes a bracing atmosphere is needed, and sometimes a relaxing atmosphere, but in general, "ideal" weather may be defined as follows: First, a daily mean temperature of about 65°, with moderate changes from day to night and with variation from day to day sufficient to avoid monotony. Second, a relative humidity continuously moderate, say from 50 to 60 per cent. Third, moderate to brisk air movement. Fourth, abundant sunshine, but not monotonously cloudless and arid weather. In short, our bodies, though capable of withstanding considerable extremes, are best adapted to average or intermediate conditions. Nowhere will a climate be found where conditions are continuously ideal, but some climates are much more nearly so than others.

Air conditioning.—Modern mechanical progress has made possible the maintenance, both winter and summer,

of proper temperature, humidity, and air movement within buildings. Air may be conditioned to nearly ideal requirements in these respects in homes, hospitals, shops, offices, factories, railroad cars, and steamships. Conditioned air, however, lacks, for reasons yet unknown, some of the stimulating quality of outdoor air, and further investigation is needed on this subject. Air conditioning also involves the cleaning of the air, that is, the removal of dust and organic particles. The removal of these particles has a special value in the prevention of some respiratory diseases.

In maintaining the proper temperature within buildings in winter, it is generally assumed that furnaces will be started when the mean daily temperature falls below 65°F. Note the practical agreement with the most favorable temperature mentioned on page 321. The difference between 65° and the average temperature of a given day that is cooler than 65° is the number of *degree days of heating* required. For example, if the average temperature of a winter day is 40°, the number of degree days for that day is 25. The sum of these degree days for a month or a season bears a relation to the amount of fuel consumed, though other weather factors, such as wind, also influence the fuel consumption. When there is summer cooling of air within doors, a temperature of 70°F. is sometimes taken as the base, and the number of *degree days of cooling* is the accumulated excess of the mean daily temperature above 70°.

Climate and Culture

We are what suns and winds and waters make us;
The mountains are our sponsors, and the rills
Fashion and win their nursing with their smiles.
—Landor.

As all the people living in a given part of the world are subjected to its favorable or unfavorable climatic conditions for many generations, it is natural that the effects of these influences will be cumulative and show themselves in the

energy, physical and social condition, and civilization of the people.

Climatic hypothesis of civilization.—The many ways in which man's climatic environment affects his daily life and activities are manifest, but that the climatic factor of environment largely determines a people's place in the scale of civilization and culture is not so obvious nor so generally recognized. There are those who maintain that the highest civilization is possible only under the most favorable climate, and that a map of civilization today is essentially a climatic map. This is called the *climatic hypothesis of civilization*. This hypothesis does not deny that other factors, such as heredity and religious philosophy, for example, are necessary in the making of a high standard of national life, but asserts that climate is also one of the essential factors.

Influence of extreme climates.—It is evident that man is limited by extremely adverse weather, and there are many illustrations of the effect of the climate upon man's clothing, food, dwellings, customs, and occupations. The following summary of these effects has been suggested by Professor R. DeC. Ward's discussion of climate in its relation to man. At one extreme of climate, food is almost wholly of fruits, such as bananas, coconuts, and breadfruit; at the other extreme, the Esquimaux must depend upon fish and the flesh and fat of animals. In equatorial regions soil production is abundant and spontaneous; in arctic regions agriculture is impossible. In large areas of north-east Russia, climatic conditions preclude the possibility of agriculture; food is scarce; fishing, hunting, and reindeer breeding are the chief occupations, and diseases of the eye are common, owing to dazzling snow outdoors and smoke indoors.

In the tropics, shelter and clothing are largely unnecessary, and the simple requirements are easily met; in polar regions, close, unventilated dwellings and heavy clothing of skins and furs must be provided by hard labor and much

danger. In Greenland, for example, a large percentage of the deaths is in snowstorms or by freezing or drowning, and deaths are most frequent during the sealing season. The climate of the tropics encourages indolence by its physically enervating influence and permits it by making energetic activity unnecessary. The climate of the polar regions enforces a laborious and dangerous activity in obtaining the bare necessities of existence. In the tropics, life is too easy, and there is no stimulus to activity; in arctic climates, life is too hard, and there is no possibility of accumulation and leisure. In both extremes climate very evidently limits progress.

Climate and the beginnings of civilization.—Relative to the influence of climate under less extreme conditions, some suggestion is afforded by the origin and migration of the early centers of culture. Man in his primitive condition probably began to make progress toward civilization and refinement in the less enervating portions of tropical or semitropical regions, where it was possible for him, even with his limited mastery of nature, to obtain leisure for contemplation. The history of civilization since that time discloses a gradual movement into colder regions, as man increased his knowledge of how to make a living on this earth and how to protect himself from adverse weather conditions. Some of the earliest well-developed types of culture were in the valleys of the Nile and of the Tigris and Euphrates Rivers, under arid, semitropical conditions, where agricultural production and the accumulation of food were comparatively easy, except that agriculture required irrigation and, hence, coördinated effort and organized society. From these valleys, the center of civilization moved to Greece and then to Italy and, later, northward through Europe into increasingly stimulating climates, from Spain and Portugal to Holland, Great Britain, and Scandinavia.

The temperature of civilization.—The present center of world progress and of western civilization is in the middle

latitudes, where there is considerable daily variation in weather and a still greater annual variation. That such climates are the most conducive to human activity and human energy is the conclusion reached by Ellsworth Huntington¹ in his studies of the influence of temperature, humidity, and other weather elements upon individuals and small groups. The climates best meeting the requirements are in a belt of the Northern Hemisphere which includes most of Europe, the British Isles, the greater part of the United States, a narrow strip of southern Canada, and Japan. The same belt includes all the most highly developed nations of today. A map of present-day civilization is, then practically a map of what has by independent investigation been found to be the most energetic climate. Temperature is probably the most important of the weather factors influencing human energy, and all of these highly developed nations are within a zone where the average annual temperature is between 40°F. and 70°F. This has been called "the temperature of civilization." The most highly developed and most energetic portions of America and Europe are within a much narrower belt, averaging about 600 miles wide, where the average annual temperature is between 50°F. and 60°F.

Conclusion.—These facts do not justify us in assuming that a high type of civilization cannot develop elsewhere, but they seem to indicate that present-day progress, characterized by energy and movement, is largely conditioned upon the stimulating, invigorating climate of the middle temperate regions of the globe. We can agree with Huntington that, "Among the physical stimuli which may control human efficiency, none is more potent than climate."

Agricultural Meteorology

The subject of agricultural meteorology includes all those relations, direct and indirect, between climate and weather

¹ Huntington, Ellsworth, *Civilization and Climate*, Yale University Press, New Haven, 1915.

and the life and growth of cultivated plants. It deals with the effects of varying temperatures and varying amounts of sunshine and soil moisture, with the climatic requirements of the important field crops, and with the relations of the sequence of weather to the progress and yield of crops. Many details of these effects and relations are yet unknown, for agricultural meteorology is a new and imperfect science, despite the great age of agriculture as an occupation.

Climate and crops.—The close relation between the climate of a region and the kind of plant life it supports is obvious. Nature decides in the first instance what use can be made of the land, and man adapts himself to her limitations and variations. Precipitation, temperature, sunshine, and length of growing season are the chief factors governing the distribution of plants. In the United States a large area having long, hot, and wet summers, produces cotton; another region with shorter growing season and less water is largely devoted to corn and winter wheat, while spring wheat matures in a still shorter and drier season far northward into Canada. A large region with climate well adapted to hay and pasture extends from Minnesota to the Appalachian Mountains and the middle Atlantic states. More specialized climatic conditions limit the commercial production of sugar cane, sugar beets, potatoes, and fruits to smaller areas in various parts of the country.

Favorable temperature and precipitation are the chief assets of any country. If temperatures are too high or too low, seeds will not germinate, the plant will be retarded in its growth or even killed, blossoms and fruit will be damaged. Different species of plants have different temperature requirements, but for all plants there is some limiting temperature, below which they will not grow. Some hardy plants will grow when the temperature is near or slightly below freezing; on the other hand, such tropical plants as date palms require a temperature of about 64°F. to start growth. The growth of citrus fruits is limited by temperature to very small areas in the United States. Often small,

local, differences of temperature determine the selection of land for oranges in southern California. Outside of the tropics, most agricultural crops begin to grow at about 43°F. (6°C.), but growth is most vigorous and healthy when the temperature of the soil is between 65° and 70°F. Perennial plants retire into a *rest period* when the temperature is below 43°.

Precipitation is essential to supply the moisture by which food is taken from the soil in solution and carried throughout the plant by the sap. It is also necessary to prevent the drying and wilting of the leaves, from which large quantities of water are transpired to the air in the growth processes. The significance of precipitation as an asset is illustrated by the difference between eastern Kansas and western Kansas in the value of land and the density of population.

Weather and crops.—Climate largely determines what shall be the staple crops of a region; the weather of the individual seasons largely determines the yields of those crops. It is often not so much the total rainfall and the average temperature that fixes the yield, as the distribution of moisture and favorable or unfavorable temperature through the season. There are certain short *critical periods* in the growth of many crops, during which their success or failure is largely determined. With some crops and in some climates, temperature is the controlling factor; with others, it is rainfall or sunshine. For example, corn can recover from earlier droughts, but if it suffers for moisture while tasseling, the yield will be small. J. Warren Smith found that the first 10 days of August are the most critical, in the production of corn in Ohio. This is the time when a good shower is truly a "million dollar rain." Winter wheat needs cool and moist weather while growing rapidly, but warm and dry weather while the heads are forming and filling. Potatoes require cool weather with plenty of moisture, especially during the 10 days following blossoming. The rainfall of May largely influences the production of hay in

a large part of the United States. A relatively cool and wet August is of importance in the production of cotton in our southern states.

The relations just mentioned and many similar ones have been discovered largely by the methods of correlation. Records of crop yields are compared year by year with records of temperature, rainfall, or other weather elements, and the influence of the weather's variations on the yield is determined. A general indication of the relation of yield to rainfall or other weather elements may be obtained from a simple dot chart, illustrated in Fig. 102, in which the departure of the yield year by year from the average yield of spring wheat in North Dakota is plotted against the May and June rainfall departure of the same year. The knowl-

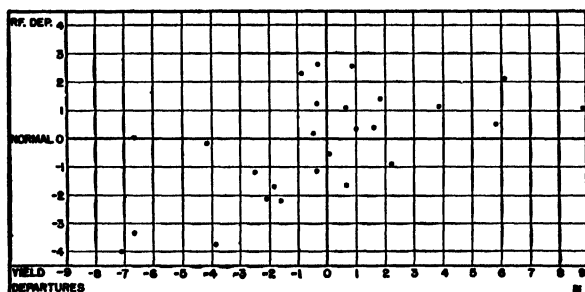

Fig. 102. Relation Between the Rainfall of May and June and the Yield of Spring Wheat in North Dakota. In the 13 years when rainfall was above average, yield was above average 9 times; in the 13 years when rainfall was average or below, yield was below average 10 times.

edge of these influences helps in the adjustment of crops to the most favorable climatic conditions. It helps to decide whether a given crop is well adapted to a given region. Sometimes by the use of different varieties or different methods of cultivation or by varying the time of seeding, the time of occurrence of the critical periods can be adjusted to the time when the weather is most likely to be favorable. It is obvious that a knowledge of the water requirements of plants at different stages of their growth is particularly applicable to farming under irrigation.

The factors influencing the yield of a given crop at a given time and place are many and complex, and include condition of soil, tillage, and seed, in addition to the weather. The efficiency of a given amount of rain in producing a crop is influenced, among other things, by the amount of evaporation. In the arid southwest, evaporation is great, partly because of low humidity and the infrequency of clouds, together with high average temperatures, and crops require more water there than they do in cooler, cloudier regions. In addition to the direct effects of atmospheric conditions on yields, there are the indirect effects resulting from the development of plant diseases and insect pests. Grain rusts are encouraged by hot and humid weather at the ripening stage of the grain; the extent of boll weevil damage to the cotton crop is related to sunshine and humidity during the growing season, and also, since low temperatures kill the weevil, to the minimum temperatures of the preceding winter.

Droughts.—A drought is a continued lack of moisture, so serious that crops fail to develop and mature properly. The dry period is of particular significance when it is of unusual length as compared with normal conditions in the area. A period of two summer months without rain would not be serious in California, because it is the usual thing, but one rainless summer month in central and eastern portions of the country would constitute a severe drought. The severity and effect of long dry periods depend not only on their duration but also on the attending temperature and wind, on the kind and previous condition of the soil, and on the condition of the crops. For these reasons, no exact definition of a drought in terms of the number of rainless days can well be given.

Phenology.—In a great degree the growth of plants is a response to the atmospheric influences to which the plants have been subjected, a summation of weather influences. Plants are nature's record of the climate and weather. A record of the progress of plants through the growing season

is, then, in part, a weather record. A record of the time of leafing, blossoming, and fruiting gives an indication of the progress of the seasons. Averages obtained from these records are a function of the climate of a region, and the yearly variations from the average are an indication of how the weather has varied. These data form the basis of the science of *phenology*, which may be defined as the study of the phenomena of life, especially plant life, as they recur from year to year, and their responses to weather and climate. Although agricultural practices are in the main determined by long experience, the knowledge gained through phenological records aids in the adjustment of farming operations to the most favorable weather conditions. The data are indispensable in the calculation of correlations between weather and crop yields.

Aeronautical Meteorology

In the use of the air as a medium through which to propel great ships of many tons' weight, some knowledge of the properties and behavior of the air is obviously necessary. The operation and safety of airplanes are not independent of atmospheric conditions. With the development of aviation has come a more intensive use of weather data. The Weather Bureau and the Civil Aeronautics Administration have developed, along the principal airways of the country, a service, by means of which the officials at the principal airports and the pilots in flight are kept constantly informed of weather conditions along the routes traveled and are provided with very specific forecasts for a few hours in advance.

Airway observations.—At airway weather stations regular observations are made and recorded hourly; at most stations this is continued for 24 hours each day. In addition, special observations are made whenever marked changes in weather conditions occur. All these observations are transmitted over teletype circuits and made available for use of other stations throughout the country. Four

times daily, at the hours of 1:30 and 7:30 A.M. and P.M., Eastern standard time, these are collected at major airports and made the basis of weather maps and forecasts. Stations at a considerable distance on both sides of the airway also make and send observations for use on these maps.

The elements of an hourly observation are:

1. Ceiling.
2. Sky.
3. Visibility, when less than 10 miles.
4. Weather—rain, snow, sleet, hail, thunderstorm, etc.
5. Obstructions to vision—fog, haze, etc.
6. Sea-level barometric pressure.
7. Temperature.
8. Dew point.
9. Wind—direction, velocity, and character. Character is described by such words as *variable*, *fresh gusts*, *strong gusts*, etc.
10. Altimeter setting—a pressure to which the airplane's altimeter should be set in order to indicate the correct elevation at destination.

Sky conditions are reported in five classes as follows:

1. Clear—less than 1/10 of sky covered by clouds.
2. Scattered clouds—from 1/10 to 5/10 of sky covered.
3. Broken clouds—more than 5/10 but not more than 9/10 of sky covered.
4. Overcast—more than 9/10 of sky covered.
5. Dense fog, dense ice fog, thick smoke, thick haze, thick dust, thick blowing snow, thick blowing dust, thick blowing sand. *Dense* means a visibility of 1/5 mile and less; *thick* means a visibility of less than 1 mile.

Airway forecasts.—Official airway forecasts are made at a general supervising station in each airway district. They include forecasts of ceiling, visibility, sky, precipitation, fog, haze, smoke, icing, thunderstorms, squalls, and are in two parts, regional and specific. *Regional forecasts* give a word picture of the changes expected in the general meteorological situation during the forecast period. *Specific*, or *terminal*,

forecasts give the expected weather conditions at each important terminal or landing point. Regional and specific forecasts cover a period of 8 hours, beginning 2 hours after the regular collection times at 6-hour intervals. In addition, special forecasts are made whenever conditions change rapidly, and special trip forecasts may be made at any time. The principal air transport companies employ their own meteorologists, who cooperate with the government officials and supplement the official forecasts by special advice to their own pilots at the beginning of each flight. Clearance is given to the pilot by the company meteorologist and is given only when he knows the weather conditions and thinks them safe, not only at the destination but also at intermediate and surrounding airports. In the making of forecasts, use is also made of observations received from airplanes in flight and of the regular upper air observations, when available.

Airway operation.—In addition to the specific information furnished by the forecasters, the pilot should have enough knowledge of meteorology properly to interpret the reports and forecasts and to understand the significance of any changes that he may encounter while in the air. He needs to know the characteristics of depressions and anti-cyclones, of warm and cold fronts; under what conditions to expect unusual turbulence, and when ice is likely to form on the wings. He should recognize quickly the various cloud types and their methods of formation and know when to attempt to fly under them or over them. A knowledge of the average frequency of different wind directions and velocities and their changes with altitude is important to the pilot. The wind may be taken advantage of in flying, since it is frequently from different directions at different levels. At ordinary flying levels of 1,000 to 5,000 feet, a plane can make about 7.5 miles per hour greater speed in going from Chicago to New York than in going from New York to Chicago, because the prevailing wind is from the west.

Thunderstorms present an important hazard in flying, because of the violent vertical movements of the air, up and down movements in close proximity to each other, and because of the danger of being struck by lightning. Flight through thunderstorms should never be attempted. Turbulent vertical movements, producing what is called bumpiness, are frequently encountered though no thunderstorms nor cumulus clouds are present. The bumps are due mainly to daytime convective air movements caused by differences in the heating of the earth's surface. Bumps occur to the leeward of changes in the character of the surface covering, as along the borders of forests, and where cultivated and grass-covered areas meet. Even such narrow strips as roads and creeks are often marked by bumps, with ascending currents over roads and descending over creeks. Bumpiness due to such irregularities of surface heating is ordinarily greatest within the first 2,500 feet above the ground, but there are times when convective irregularities extend to much greater heights. A somewhat different type of bumpiness is encountered in the waves occurring at the surfaces of different air layers, and these may be at any elevation.

Low clouds, fogs, and poor visibility are also important hazards, especially in landing, and the flier should know when these conditions are dangerous. A means of dissipating fogs at landing fields is in much demand. Before the site of an airport is selected, a detailed study of the local weather and climate should be made. This study should have special reference to the frequency of fog, dust, smoke, and other impairments of visibility, the frequency of thunderstorms, and of winds from the different directions and of various velocities, and the gustiness of the winds.

Safe and regular airway operation is wholly dependent on frequent weather reports and upon a knowledge of the behavior of the air. The development of aviation to its present status would have been impossible without the aid of meteorology. The aviator must also be a meteorologist.

The better the pilot understands and interprets what is happening in the air around him, the more successful he will be in avoiding the difficulties and dangers of flying.

With a close network of stations making hourly observations, with increasing use of upper air data, obtained from airplanes in flight and from radiosondes, and with increasing experience in air-mass analysis and interpretation on the part of the forecasters and more knowledge of meteorology on the part of the pilots, there is increasing efficiency of airway operation and decreasing risk in air transport.

Summary

Weather and climate are not specific causes of disease, but atmospheric conditions have much to do with man's energy and vitality, and they directly limit some diseases. The death rate is lowest when the mean daily temperature is between 60° and 75°, and a temperature of about 64° is the optimum temperature for active work. For comfort and health, air should be of moderate humidity, whatever its temperature. Very moist air is oppressive, and very dry air is irritating. Stagnant air is also objectionable, and moderate to brisk movement is stimulating. The effective temperature felt by the body is due to the combined influence of air temperature, humidity, and movement. These 3 elements in proper degree, together with abundant sunshine, comprise the requirements of ideal weather.

The cumulative effects of depressing or invigorating climatic conditions appear to be reflected in the degree of progressiveness and the state of civilization of the peoples of the world. The regions of extreme climates, whether too hot or too cold, are regions of little progress in culture. The most active and progressive peoples are those living in middle latitude regions of moderate but changeable weather. The history of civilization shows a gradual migration from subtropical to progressively more rigorous climates.

The relation of plant life to climate and weather is still more evident. Normal temperature and rainfall largely determine the crops to be grown in any region, and crop yields from season to season are governed by the actual favorable or unfavorable incidence of heat and moisture during the year, and especially during certain short critical periods of plant development. Definite numerical relations between weather occurrences and subsequent crop yields have been determined by statistical analysis of phenological data.

With the development of aviation has come a more intensive use of weather data; a more frequent and more detailed observation of atmospheric conditions as they exist at the time, and more frequent and specific forecasts of conditions expected within a few hours. Detailed meteorological information is a prime essential in maintaining regular flying schedules. Aviation is dependent on meteorology, and meteorology has received an important stimulus from the development of aviation.

Problems

1. By spending a month in each of 12 cities in the United States, one might pass the year under nearly ideal temperature conditions, assuming that normal temperatures prevailed. What cities might one select?
2. What is the mean annual temperature of each of the 10 largest cities of the world? How much do the cities differ in this respect? Is there a relation between their size and their temperature?
3. Discuss what period without important rain constitutes a drought in your state. How is the length of the period related to the time of year, temperature, wind, previous condition of the soil?
4. What amount of rainfall is required to break the drought?
5. How frequently do such droughts occur?

CHAPTER XIV

Electrical and Optical Phenomena

Certain electrical and optical occurrences in the atmosphere are of general interest in connection with meteorology, although for the most part they have little relation to what is ordinarily meant by *weather*. The most frequent electrical display in the air and the one most directly related to weather is lightning, which has been discussed in connection with thunderstorms. This chapter presents a summary discussion of other important electrical and optical phenomena of the atmosphere.¹

Electrical Phenomena

Electrical field of the earth.—In the discharge of a lightning flash from a cloud to the earth there is evidence of a great difference of electrical charge between the cloud and the earth, but it is not only in a thunderstorm that such a difference exists. There is a continual difference of potential between the earth and the atmosphere, that is, one has a greater electrical charge than the other. Usually the earth is negative as compared with the air; but reversals frequently occur in thunderstorms. The potential gradient differs from place to place, at different times of the year, and at different times of the day. It is greatest in fall and early winter and least in summer.

Conductivity of the air.—This electrical charge on the earth continues even though there is a gradual loss of charge

¹ For more detailed descriptions and physical explanations the reader is referred to Humphreys, W. J., *Physics of the Air*, McGraw-Hill Book Company, Inc., New York, 1929.

through the air. Although the air is a poor conductor of electricity, it is not a perfect insulator, because of the presence of free ions. The number of ions in the atmosphere, and hence its conductivity, change with changing weather conditions. As a consequence of the conductivity of the air, there is a current between the earth and the atmosphere sufficient to neutralize the earth's charge in a short time. It is thought that a preponderance of negative electricity in lightning flashes to the earth and a preponderance of positive electricity in the brush discharges of pointed conductors connected with the earth help to maintain the earth's negative charge. Whether these are quantitatively sufficient, or whether there are other compensating currents, is not known. There are known to be frequent irregular currents in both directions. The best-known example of a brush discharge is called *St. Elmo's fire*, and consists of short streamers of light appearing at the ends of pointed objects, especially on mountains.

Auroras.—An electrical phenomenon of the atmosphere having notable optical effects is the *aurora polaris*, in which the gases of the upper air, especially oxygen and nitrogen, are made luminous by electrical discharges, much as rarefied neon is made luminous in the familiar neon street lights. The aurora of the Northern Hemisphere is called *aurora borealis* or *northern lights*; in the Southern Hemisphere, the name is *aurora australis*. Auroral displays are most numerous around the magnetic poles of the earth and are closely related to magnetic disturbances on the earth, such as those which hamper telegraphic communication and result in erratic movements of compasses. They are also related to the sunspot cycle; the greatest number of auroras occurs at times of sunspot maxima. Auroras are evidently connected with electrical discharges from the sun, but the exact nature of the discharges and of their relationship to auroras and magnetic disturbances is not known.

The electrical disturbances occur either day or night, but the optical effects are visible only at night. The displays

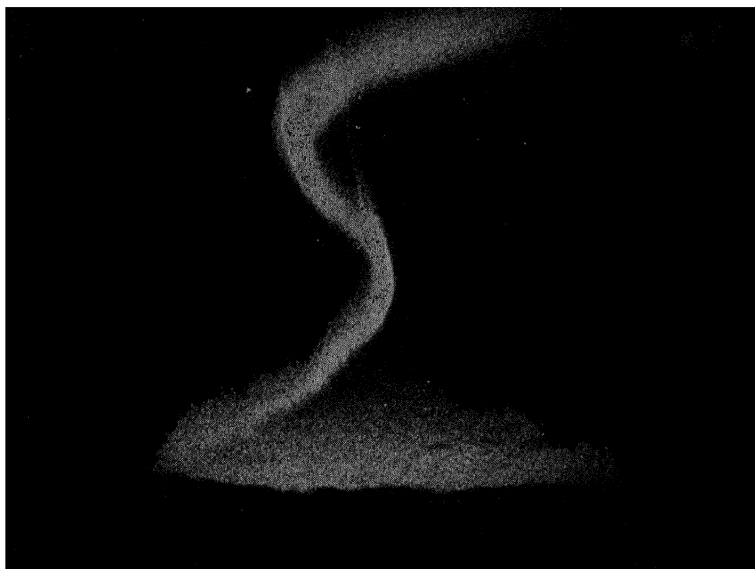

Fig. 103. Aurora Band Just After Sunset, Looking Westward at Bossekof, Norway, March 3, 1910. (*Courtesy, U. S. Weather Bureau.*)

take the form of arcs, bands, rays, curtains, coronas, or luminous patches, the same aurora often undergoing rapid changes in appearance. Those showing a ray-like structure are especially active and colorful. Most arcs, bands, and patches are white only, but the rays often show red, green, yellow, and violet. The distance of auroras from the earth varies from 50 to 190 miles (80–306 km.), but the great majority occurs between 55 and 80 miles (89–129 km.). It will be noted that these heights correspond to the heights of the ionized layers as indicated by radio waves, that is, that auroras occur within the ionosphere. In the Northern Hemisphere they occur most frequently in a zone which crosses Alaska, northern Canada, southern Greenland, Iceland, and northern Norway. The frequency decreases rapidly with decrease of latitude. Auroras are not very frequent in the northern United States and are rare in southern Europe.

Optical Phenomena

Refraction.—In passing from one medium to another of different density, waves of radiant energy are *refracted*, or bent from their original straight line course, except when they are traveling perpendicularly to the surface separating the two media. The bending is explained by the fact that the waves travel at different speeds in media of different densities. The function of lenses in microscopes, telescopes, and eyeglasses is to bend light out of its course. A straight stick partly immersed in water appears to be bent, because the light by which we see it is refracted at the water's surface. White light is composed of waves of differ-

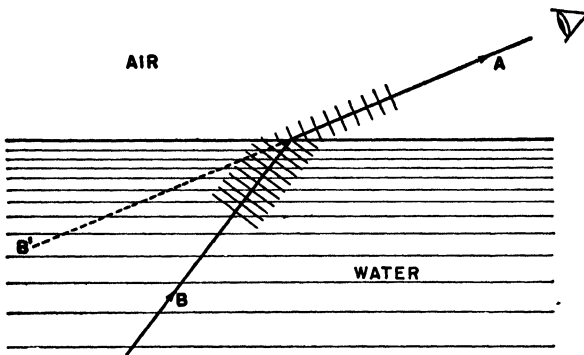

Fig. 104. Refraction of Light on Passing from One Medium to Another of Different Density. The wave front travels more rapidly in the thinner medium and is bent out of a straight line course. From *A*, an object at *B* appears to be at *B'*.

ent lengths, and the longer waves are refracted less than the shorter ones. When white light is passed through a glass prism, it is separated into colored bands. In the spectrum which is thus produced, there is a regular gradation of colors, but for convenience seven colors are often distinguished and called primary colors. These are red, orange, yellow, green, blue, indigo, and violet, in the order of their wave lengths, red being the longest. Light is also bent on passing through air of changing density. In this case the

refraction is too diffuse to produce a separation into colors; it results in a gradual change in the direction of the wave.

Atmospheric refraction.—One effect of refraction in the air is to bend the rays of light coming from the sun, moon, or stars, when they are near the horizon, into a curved path which renders these objects visible when they are, whether rising or setting, in reality about a half degree below the horizon. It is the increasing density of the lower air that causes the rays to be bent downward and gives to distant objects a greater apparent than actual elevation. A ray of light from *A*, Fig. 105, follows the curved path *AO* to the observer at *O* and appears to come from *A'*. The effect of

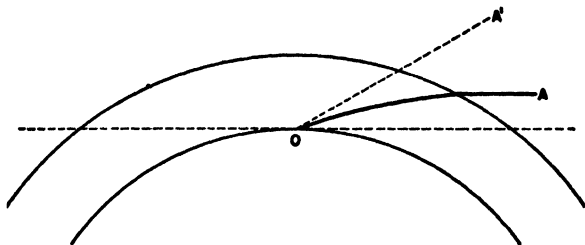

Fig. 105. Atmospheric Refraction Resulting from the Air's Increasing Density Downward.

this refraction with respect to the sun is to lengthen the day by a few minutes in lower and middle latitudes and by more than 24 hours in polar regions during a part of the year. Another effect is to flatten the disk of the sun or moon when they are on the horizon.

The twinkling of the stars is also a refraction phenomenon, resulting from the movement of masses of air of different densities across the line of sight. Sometimes when the air is free from visible dust and condensed moisture, it has a haziness which renders distant objects indistinct. This occurs especially on hot days, when convection is active. It is called optical haze and, like the twinkling of the stars, is due to the unequal refraction of light passing through air of varying density.

Mirage.—In addition to the usual results of atmospheric refraction just described, special optical effects known as mirages are occasionally seen. These occur when there are strong temperature contrasts in adjacent air layers. The most common forms of mirages are those in which there are deceptive appearances of water surfaces and those in which there are images of distant objects. The common *inferior* mirage, producing the illusion of a water surface, often seen in flat desert regions on quiet, sunny days and also, on a small scale, on paved roads, is due to a thin, heated surface layer of air, perhaps 3 or 4 feet in thickness, with considerably cooler and denser air above it. This is a condition favorable for convection, but in which convection has not yet begun, because of lack of turbulence and the slow transfer of heat by conduction and radiation. The apparent water surface is the image of the sky. The eye of the observer must be somewhat above the heated layer. In this type of mirage a distant object and its inverted image some distance below it are sometimes seen. Because the image is below the real object, it is called an *inferior mirage*.

Over water and over cold land surfaces, a cold layer of air at the surface and warmer air above it sometimes produce a *superior mirage* in which a distant object and two images above it are seen. For instance, one may see a ship in the distance, and apparently another ship above it floating upside down, and above this still another ship, upright in this case. These phenomena are due to gradual bending of the light. We speak of layers of warm and cold air, but it should be understood that the transition from one layer to another is not abrupt. There is mixing and a gradual change in the refractive power of the air, and the effects seen in mirages are due to this continuous variation. Complete stratification, with mirror-like bounding surfaces, does not occur in nature.

Rainbow.—When a ray of sunlight enters a drop of water, a part of it does not pass directly through but is reflected from the inner surface and emerges on the side from which

it entered, being refracted both on entering and leaving the water (see Fig. 106). In this way are produced the concentric colored arcs of the primary rainbow, having a radius of about 42° , with the red on the outside. A portion of the light, however, is twice reflected before emerging, producing the secondary bow, with a radius of about 50° , in which the

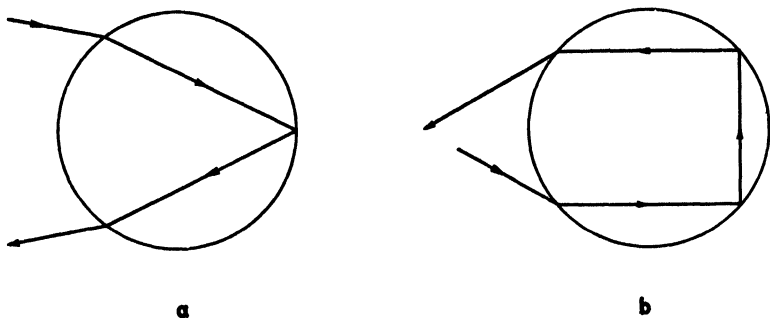

Fig. 106. Path of Light in Producing a Primary Rainbow, *a*, and a Secondary Rainbow, *b*.

red is on the inside. It is usually not possible to distinguish all the primary colors, because of overlapping of the spectra from different drops of water. The larger the drops, the narrower and brighter is the bow produced.

The observer of a rainbow is always between the sun and the falling rain and in the line connecting the sun and the center of the circle of which the rainbow is an arc. Each observer sees a different rainbow, that is, a bow made by different drops of water. If the sun is on the horizon, it is possible to see a complete semicircle; if the sun is more than 42° above the horizon, no primary rainbow is possible. Lunar rainbows are sometimes seen.

Halo.—When light from the sun or moon passes through thin upper clouds composed of ice crystals, various circles or arcs of light may become visible. These are *solar* or *lunar halos*, respectively, and are produced by refraction. The most common halo is a ring, or portion of a ring, of 22° radius, around the sun or moon. (The angular diameter

of the sun and of the moon is about $\frac{1}{2}^\circ$.) A halo of 46° radius is sometimes seen, and occasionally there are other circles and arcs making complex figures, in which reflection also plays a part. The various figures are due to differing shapes and positions of the falling ice crystals through which the light passes. Halos are often nearly white, but a well-developed halo of 22° is red on the inside, shading off to yellow. A *parhelion* is an image of the sun, a *mock sun*, or

.z

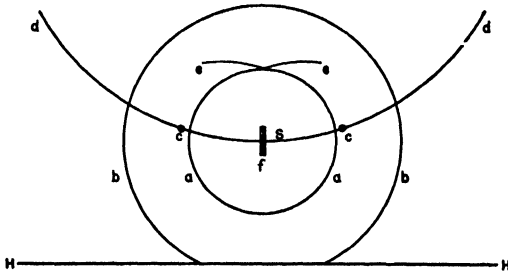

Fig. 107. Some of the More Frequently Observed Halo Phenomena. *HH*, horizon; *S*, sun; *Z*, zenith; *aa*, halo of 22° ; *bb*, halo of 46° ; *cc*, parhelia of 22° ; *dd*, portion of parhelic circle; *ee*, upper tangent arc of halo of 22° ; *f*, sun pillar. (After *W. J. Humphreys*.)

sun dog, produced by similar refraction and often in connection with the halo of 22° . It is either white or colored. The parhelia most frequently observed are on opposite sides of the sun at a distance of 22° and are red nearest the sun. The corresponding image in connection with a lunar halo is called a *paraselene*.

Diffraction and scattering.—Light rays are diverted from a straight course, made to curve around a corner, as it were, when the obstacles encountered are sufficiently small compared with the wave lengths of light. This phenomenon is called *diffraction* of light and results in the formation of alternate light and dark or colored bands. Diffraction is

the cause of the *corona*, a bluish-white aureole sometimes visible immediately around the sun or moon, when these are veiled by a thin cloud composed of water droplets. The outer rings of a corona often show some rainbow-like coloring.

Very fine dust particles in the upper air, and even the molecules of the gases of the air, cause *scattering*, a diffusion or dispersion of light somewhat similar to diffraction. Scattering of light decreases the intensity of direct sunshine but greatly increases the brightness of the sky away from the sun and the amount of light received by objects in the shade. Scattering and diffraction are responsible for the blue color of the sky and for the changing, often brilliant, colors of twilight. Overhead in a clear sky, the short, blue waves penetrate the air; near the horizon, the light must pass through long distances of the dusty lower air, and only the longer waves toward the red end of the spectrum succeed in getting through. That these colors are due to the influence of the lower air is shown by the fact that space appears nearly black when viewed from the stratosphere.

Twilight.—The existence of the phenomenon of twilight is due in part to diffraction and scattering and in part to reflection of sunlight from the upper atmosphere. Some light from the upper air reaches us more than an hour before the sun is above the horizon in the morning (more than 2 hours at some seasons in northern portions of the United States), and some light continues for a like period in the evening after the sun has set. This is the period of *astronomical twilight*, when the sun is not more than 18° below the horizon. The time that it takes the sun to move 18° toward or away from the horizon depends upon the angle which the sun's apparent path makes with the horizon, and hence upon the latitude and the time of year. In general, it is too dark for outdoor work when the sun is more than 6° below the horizon. Hence, the interval between the time when the sun is on the horizon and when it is 6° below is called *civil twilight*. The duration of this interval also

varies with the latitude and the time of year. It averages about 22 minutes at the equator, about 29 minutes at latitude 40° , and about 37 minutes at latitude 50° .

Summary

In addition to the thunderstorm, which is familiar in most parts of the world, there are other evidences of electrical activity in the air. The most notable of these is the aurora, in which the thin air of the ionosphere is made luminous by electrical influences emanating from the sun. Auroras are visible at night as patches, arcs, or rays of light, the latter often colored. They are phenomena of higher latitudes centering around the magnetic poles and are seldom visible in latitudes lower than 40° .

By some unknown means a difference of electrical potential is maintained continually between the earth and the air, notwithstanding a slow leakage of electricity through the air because of the presence of free ions.

Light on its way from the sun to our eyes must pass through the atmosphere. In doing so, it is often turned aside from a straight path and reaches us indirectly, because of the varying density of the air or because of the presence of water drops, ice particles, or dust in the air. Differing air densities cause a bending of light rays, resulting in an increase in the apparent elevation of the sun, moon, and stars when these are near the horizon. The same conditions cause the twinkling of the stars, and the occurrence of mirages when there are sharp density contrasts between adjacent layers of air.

When light from the sun falls upon water drops in the air, the same process of bending, or refraction, aided by internal reflection, results in the formation of rainbows. Very fine water particles forming a haze or thin cloud high in the air turn the light aside, and this diffraction results in the formation of coronas around the sun or moon. Ice crystals in thin upper clouds produce various forms of halos by refraction of the light. Fine dust particles in the air, as well

as fine water particles, turn the light aside and scatter it, producing the blue color of the sky and the various brilliant colors of twilight. We receive some light from the sun for an hour, more or less, before the sun has risen in the morning, and after it has set in the evening. This is caused partly by reflection and partly by diffraction and scattering.

CHAPTER XV

The United States Weather Bureau

Meteorological services are essentially government functions and are so recognized by all modern nations. The collection and dissemination of weather information and the preparation and publication of weather forecasts and climatic tables naturally belong to governmental agencies, first, because they require an organization covering an entire nation and interchanging data freely with other nations, and, second, because they are essential to so many activities and must be unprejudiced, impartial, and freely accessible to all. Without such a government service, many enterprises, especially steamship companies, railroads, and air transport companies, would find it necessary to establish independent services, resulting in duplication and increased expense to the public.

Development of an Official Weather Service in the United States

In the early history of this country, a few individual weather records of considerable length were kept. Some of these have been preserved and are of much value, but there was no systematic, organized collection of data. In the rapid development of the country during the first half of the nineteenth century, the need for information concerning weather and climatic conditions was widely felt, and numerous governmental agencies began to collect such data, as an incidental and rather extraneous part of their work.

Beginnings of organized weather observations in the United States.—The first of these agencies was the Govern-

ment Land Office, which began in 1817 a system of precipitation records and tri-daily observations of temperature at its various local offices, which were widely distributed in the newer portions of the country. In 1819, regular observations were begun at the military posts throughout the country. In 1841, the Patent Office organized a body of weather correspondents, or voluntary observers, and inaugurated systematic observations. The Smithsonian Institution did likewise in 1849, and in 1857 it began receiving telegraphic reports of simultaneous observations, from which Professor Joseph Henry, then Secretary of the Smithsonian Institution, prepared weather maps and forecasts. This service ceased in 1861 due to the outbreak of the Civil War.

Abbe, Lapham, and the Signal Service.—After the Civil War, Professor Cleveland Abbe at Cincinnati, aided by the coöperation of business organizations and the telegraph company, arranged to receive telegraphic reports of weather conditions, and from these, in 1869 and 1870, he prepared daily synoptic charts and issued statements of weather “probabilities,” especially with reference to storms on the Great Lakes. The time was now ripe for the organization of a government weather service in the United States, as had already taken place in some European countries, and Increase A. Lapham of Milwaukee was instrumental in having introduced into Congress a bill providing for such an organization. The provisions of this bill became law on February 9, 1870. The law required that the Signal Service of the U. S. Army make meteorological observations at its military stations and at other points, and that it give notice of the approach and force of storms. General Albert J. Myer, Chief Signal Officer, proceeded to the work of organizing the new service, which began operations on November 8, 1870, with Lapham as meteorologist. In 1871 Abbe also became connected with the official weather service and continued as one of its leading scientific officials until his death in 1916.

The official weather service continued to be conducted by

the Signal Service for the next 20 years, with gradual extension of observational stations and increasing usefulness to the public. Although in the beginning the service was intended primarily for the issuance of storm warnings for the benefit of navigation, it soon became evident that valuable information could be given to a much wider public. The service could be useful not only in the matter of forecasts, but also in disseminating the facts of existing weather conditions and of the climatic characteristics of the country. Thus there grew into existence in response to public demand the three main features of a weather service, namely, the preparation and distribution of weather forecasts, the accumulation and publication of climatological data, and the dissemination of current weather information.

Establishment of the Weather Bureau.—During this period of growth it was necessary to develop the technique of observation and forecasting, to devise and improve instruments, to train and instruct many observers, and to provide for study and research looking toward the improvement of forecasting and the general development of the science of meteorology. As the practical services increased, and as the science developed and required greater training and specialization of those in its service, it became evident that the demands of the work could be met more fully by the creation of an independent scientific organization, free from military regulations and devoting its entire attention to meteorology and climatology. Accordingly, effective July 1, 1891, the Congress established the Weather Bureau in the United States Department of Agriculture, and the entire official weather service was transferred to this Bureau, where it remained until June 30, 1940, when Congress transferred it to the Department of Commerce. It has continually grown in scientific attainment and practical usefulness.

Present Organization

The central office.—The Weather Bureau organization consists of a central administrative and scientific office at Washington, D. C. and numerous offices and stations of

various grades throughout the nation, including Alaska, Hawaii, and Puerto Rico. It is administered by a Chief of Bureau, selected for scientific and executive attainments and appointed by the President. The appointment is permanent, with Civil Service status. All other commissioned employees are appointed after passing examinations given by the U. S. Civil Service Commission and serve under the regulations of the Civil Service Acts. They are allocated to various professional, subprofessional, and clerical grades. Appointments are usually made to the lower grades, and the higher positions are filled by promotion.

In the central office, under the Chief of Bureau, the technical services of the bureau are organized in several divisions, dealing with such services as (a) planning, organizing, and operating the network of Weather Bureau stations; (b) supervising communication schedules and the preparation and distribution of maps, forecasts, and warnings; (c) supervising the purchase and testing of meteorological instruments, and their installation, operation, and maintenance; (d) checking, summarizing, and publishing weather observations and climatic data and reporting effects of weather on crops; (e) forecasting river stages and floods and maintaining a hydrologic program. Other divisions deal with scientific services such as conducting research, editing publications, and managing the largest, most nearly complete meteorological library in the United States. There is also necessarily a considerable administrative organization concerned with such matters as personnel management, budgets and accounts, printing, and the procurement and distribution of supplies.

The field organization.—The organization outside of Washington consists of seven administrative regions, with a regional director in charge of each, over 200 first-order stations, and a large number of lesser stations of many different classes. The regional offices serve as coordinating agencies between the central office and the field stations, and between the various types of service. They handle

many administrative details in connection with supplies, equipment, inspection, and personnel. The *first-order stations* are local public offices of the Weather Bureau, manned by one to several professional and subprofessional employees, at which complete meteorological records are kept. Most of them send daily telegraphic reports of observations and issue forecast cards or weather bulletins, and many make weather maps and local forecasts. Many offices are at airports; in other cases, city offices are maintained.

The numerous substations fill a great variety of special needs. Substations are divided into the following classes: *second-order stations*, maintained primarily as weather observation stations, make daily telegraphic reports for the forecast and warning service; *third-order stations* telegraph daily weather observations at certain times for special purposes; *river substations* make and forward river stage and precipitation observations; *snowfall substations* make snow-depth and sometimes snow-density measurements; *display substations* display storm or hurricane signals or disseminate forecasts and warnings; *crop substations* make and telegraph observations for weather and crop bulletins or for frost forecasts; *climatological substations* make observations for record or climatological purposes but do not telegraph them; *airway substations* make a record of weather conditions along the airways and transmit reports at stated times; *coöperative substations* are maintained primarily for climatological purposes and make daily observations of rainfall or of temperature and rainfall and send monthly reports by mail to section centers.

Activities

The several activities of the Weather Bureau may all be classed under the head of the accumulation and distribution of weather information. They have grown in response to the needs and demands of the public and the ability of the Bureau to meet these needs, to a degree at least. The services provided have become an essential part of the daily

life of the United States, and there is continual demand for increased and more detailed information. The demands for information and advice of immediate application have largely absorbed the funds and energies of the Weather Bureau, leaving less opportunity than seems desirable for conducting research and extending scientific knowledge.

Forecast and warning service.—The synoptic observations made at 6-hour intervals, and the upper air observations made at selected stations are immediately transmitted in code over teletype circuits. They thus become available at Washington and at other forecast centers and first-order stations where forecasts are made or maps and bulletins published. From these reports the weather maps are prepared according to a uniform procedure and with uniform symbols, so that one familiar with the practice can readily interpret a weather map wherever it may have been prepared. The Washington weather map is 22 by 17 inches in size and is lithographed. Numerous other stations prepare somewhat smaller maps and either print them in their own offices or furnish them to newspapers for publication. Maps are also sent from Washington by a telegraphic process and printed in many newspapers. In connection with the maps, the Weather Bureau furnishes forecasts, weather summaries, and tabular matter. Weather maps of the north Atlantic Ocean are prepared in the New York office, and of the north Pacific in San Francisco.

For forecast purposes the country is divided into several forecast districts, each comprising a few or several states, corresponding in a general way with topographic and climatic regions. Each of these districts has a forecast center at which several forecasters are on duty, giving continuous 24-hour service. Forecasts are prepared every six hours, a separate forecast for each state, sometimes for portions of states. The forecasts based on the observations made at 1:30 A.M., 75th meridian time, sometimes called "breakfast forecasts," are distributed mainly by radio broadcasts between 5:00 and 7:00 A.M. Those based on the 7:30 A.M.

observations are ready for distribution about 10:30 A.M. and forecast the conditions for the 24-hour period from 7:30 P.M. of the same day to 7:30 P.M. of the following day.

A simple forecast, issued on Monday morning, for example, may be worded as follows: for Ohio, fair and warmer tonight; Tuesday, rain and colder. "Tonight" includes the period from 7:30 P.M. Monday to 7:30 A.M. Tuesday, and "Tuesday" applies to the 12-hour period ending at 7:30 P.M. of that day. The temperature changes are based on the current morning and evening readings. The above forecast means that it is expected to be warmer at 7:30 A.M. Tuesday than it was at 7:30 A.M. Monday, and colder at 7:30 P.M. Tuesday than at 7:30 P.M. the preceding day. A forecast of fair weather is verified if no precipitation, or not more than 0.01 inch, occurs within the period, but the forecaster will say "partly cloudy" or "cloudy" when he expects these conditions to occur within the period. The forecast of rain on Tuesday is verified if rain in any amount occurs between 7:30 A.M. and 7:30 P.M. In recent years there has been increasing use of upper air data and increasing skill in the interpretation of upper air charts, as well as of frontal movements and their effects on the weather. As a result of this added knowledge of detail and the use of weather maps every six hours, the daily forecasts have become more specific and more descriptive of the kind of weather to be expected, including probable maximum and minimum temperatures, and, in addition, the force and direction of the wind.

At many first-order stations the official in charge makes a daily local forecast for his vicinity, amplifying the state forecast, making it more specific, or occasionally differing from it. Forecasts are given wide distribution by press associations, newspapers, radio broadcasting companies, and telephone companies. The officials in charge at Juneau, Honolulu, and San Juan issue forecasts for Alaska, Hawaii, and Puerto Rico, respectively.

Special forecasts known as *warnings* are issued either in connection with the regular daily forecasts or at other times, when injurious or hazardous weather conditions are expected. Such are the storm warnings (forecasts of high winds), cold-wave warnings, stock warnings (snow, high winds, and low temperatures threatening to stock on ranges), and frost warnings. A specially organized warning service is that in connection with the occurrence of hurricanes in the Caribbean Sea and along our Gulf and south Atlantic coasts. There are hurricane forecast centers at Washington, New Orleans, Jacksonville, and San Juan, Puerto Rico, with special facilities for the rapid collection of reports from, and the distribution of warnings to, both land stations and ships at sea.

The Weather Bureau began in 1940 to issue forecasts twice a week for periods of four to five days in advance. They are made on Tuesday for the following Wednesday to Saturday, and on Friday for Saturday to Wednesday. They indicate, usually by groups of several states, whether the temperature and the rainfall will be about normal, or above or below normal, and the order in which warm and cold spells and rainy periods will occur: These forecasts are based on the average intensity of the prevailing westerly winds during the previous five days. A measure of this average intensity has been found in the difference between the mean sea-level pressures at latitudes 35° N and 55° N, taken around the globe.

When the westerlies are strong, the Aleutian and Iceland lows are large and intense. When the west winds are weak, each of these centers of action normally breaks down into two separate and weak low pressure centers. These variations modify the weather of the United States during the following five days. This method of forecasting grew out of a new way of charting and analyzing conditions in the free atmosphere, known as *isentropic analysis*, and based on

the fact that motions of the free air take place mainly along surfaces of constant potential temperature.

Climatological service.—The first-order stations are placed primarily with a view to serving as a network for forecasting purposes and as centers for the dissemination of weather news to the public. They accumulate much valuable climatological data but are not sufficiently numerous to cover the local climatic variations found in each state. To extend climatic studies to smaller areas and to establish the main features of the local climates of the country, the *climatological service* of the Weather Bureau has been organized. Climatological data are obtained by a large number of coöperative substations, well distributed, so that most of the counties of the United States are represented. There are about 4,500 such stations in the country, or about 1 to every 700 square miles of area. The stations are often only 20 to 30 miles distant from each other.

Coöperative stations are not equipped with recording instruments, but each has an 8-inch rain gage, and the majority also have an instrument shelter, inclosing maximum and minimum thermometers. They are thus equipped to obtain the climatic elements of primary importance, that is, the daily maximum and minimum temperatures, and the daily rainfall. The work of the coöperative observer consists in reading the thermometers and measuring the rain once each day, generally in the evening about sunset, and recording the readings on a standard form, which is mailed to a section center at the end of the month. The observer also usually records the state of the sky during the day, the prevailing wind direction, and phenomena of special interest, such as the occurrence of hailstorms, high winds, or frosts in spring and autumn.

The work requires only a few minutes each day and is entirely unpaid. Local residents interested in maintaining an accurate, official weather record volunteer to do the work without compensation. Many become much inter-

ested in the work and continue it for years. Large numbers of coöperative observers have served for more than 25 years, and some for more than 40 years. They perform a valuable public service, and it is a remarkable feature of the Weather Bureau's organization that such an important part of its work is made possible by the coöperation of unpaid observers.

The climatological work is grouped by states. Usually there is a section center for the assembling of climatological data in each state, but Maryland and Delaware are combined into one section, and the New England states form a single section. The direct supervision of the coöperative substations of each section is by a section director, who is the official in charge of the first-order station designated as section center. The section director recommends to the Chief of Bureau the establishment or discontinuance of coöperative stations in his section; he supervises the installation and upkeep of their equipment, selects and instructs the observers, and inspects the stations at intervals. The monthly records made by the coöperative observers are forwarded in duplicate to the section centers. There they are carefully checked, compared, and summarized. The material is then published in considerable detail in a monthly bulletin, called *Climatological Data*.

Agricultural and horticultural service.—The special agricultural service of the Weather Bureau consists largely in the publication of bulletins containing weather data and reports on the effect of the weather on the condition and progress of crops. Bulletins of temperature and rainfall are issued daily during the growing season at various stations, and weekly summaries of weather conditions and crop responses are published at the section centers for their respective districts. The central office at Washington publishes a *Weekly Weather and Crop Bulletin* throughout the year, with reports and summaries for all parts of the country. During the winter this bulletin also contains reports

of the depth of snow on the ground, and the thickness of ice in rivers and harbors.

In addition to the reports from first-order stations, the daily bulletins contain reports from the crop substations, and are named according to the principal crops grown in the areas represented. There are bulletins for the corn and wheat region, and for the cotton, fruit, sugar, rice, and cranberry regions. The horticultural service is organized especially to give warnings of frosts likely to be injurious to fruits in those regions where fruit-growing is a major industry and where protective measures are practicable. There are fruit-frost stations in California, Oregon, Washington, Texas, and Florida.

Marine meteorological service.—A large proportion of all ocean-going ships make weather observations at Greenwich mean noon each day, in whatever part of the world they may be. Large numbers of records, coming from the masters of vessels of every maritime nation, are received at the central office of the Weather Bureau and are there studied and summarized. These ships' records are the basis of our knowledge of the climates of the oceans. The summarized and charted data are furnished by the Weather Bureau to the hydrographic office of the Navy Department and are published by that office on its monthly pilot charts, used by all navigators. When a vessel is in a port where there is a Weather Bureau office, the Bureau inspects and tests the ship's meteorological equipment. When within certain areas, many ships transmit daily observations by radio. These reports make possible the daily weather maps of the north Atlantic and north Pacific Oceans and are also essential to following and forecasting the course of West Indian hurricanes, and to daily forecasting for the Hawaiian Islands. They are a great aid to the forecaster in all coastal regions.

In recent years investigations of water temperatures have been inaugurated by coöperation between the Weather Bu-

reau and certain steamship companies, especially those having vessels engaged in the Atlantic coastal trade, or entering the Gulf of Mexico or the Caribbean region. Particular attention is being given to the temperature of the Gulf Stream and of the waters in which it has its origin. Such systematic records of sea-surface temperatures should prove of value in investigations of the relations between ocean temperatures and weather phenomena. Hitherto, our knowledge of the temperature of the oceans has been meagre.

Aerological and airway service.—The aerological service is maintained for the purpose of (1) making observations of upper air conditions, (2) assembling these observations promptly at designated centers for use in forecasting, and (3) summarizing the data in form suitable for analysis and publication. The airway service organizes and operates special activities in aid of aviation, particularly on "civil airways designated by the Secretary of Commerce as routes suitable for air commerce." The upper air data are obtained by use of balloons and radiosondes, as indicated in Chapter III. The airway service is performed in a coöperative working agreement with the Civil Aeronautics Administration, and has been discussed in Chapter XIII.

Forest fire-weather service.—The fire-weather service is conducted as an aid to the fire protection forces of government, state, and private agencies. The control of forest fires is a difficult problem involving heavy expenditure of time and money and often the services of large forces of men. The efficiency of fire control is largely dependent upon forestry officials' being prepared for emergencies as they arise. Since weather, more than any other factor, is responsible for the degree of fire hazard, forecasts covering those weather elements directly bearing upon the fire control problem are invaluable. It is evident that wind is an important factor in the spread of forest fires, and it is found that the relative humidity of the air is also very important, because of its influence on the inflammability of the forest

litter. Many forest fires originate in the occurrence of lightning without heavy precipitation.

The plan of operations is to maintain meteorological substations within the forested areas, in many cases manned by Forest Service employees. During the seasons of hazard, reports from these stations are transmitted daily by telephone or telegraph to the headquarters of the forecaster for the district. These reports, in conjunction with the general weather map, are used as a basis for the formulation of specialized forecasts which are promptly distributed to fire-control officers. This service is in operation in all the principal forest areas of the country. In some places an automobile truck has been provided and fitted with meteorological and radio equipment capable of sending and receiving messages. This proceeds to every large forest fire, accompanied by a forecaster and a radio operator. Thus the forecaster is able to keep in close touch with the situation and to issue forecasts and advices closely localized and adapted to immediate needs.

River and flood service.—Along all the important rivers in the United States that are subject to overflow with extensive damage, the Weather Bureau maintains a river and flood service. The organization is subdivided into river district centers, each in charge of an official authorized to make forecasts of floods and river stages. Each district comprises one or more of the shorter rivers or a portion of the longer rivers. It contains river and precipitation stations so placed as to give the fullest possible information of rainfall and of river stages throughout the district. This information is supplemented by reports received from other districts. The stage of the rivers is expressed in feet and tenths, measured from a fixed zero mark, usually some low water mark. It does not represent the depth of the water. Daily forecasts of river stages are made where they serve a useful purpose, especially where they are an aid to navigation. They cover as long a period as is consistent with

to 36 hours in advance and indicated in more general terms for longer periods.

In all cases where the overflowing of the rivers might result in the loss of human life or livestock, or in extensive property damage, special attention is given to forecasting such floods. In the short, swift rivers, warnings are sometimes but a few hours in advance of the flood, and estimates of stages to be reached are only approximate. For the longer, more slowly moving rivers, warnings can be given a longer period in advance and with greater accuracy. In the lower Mississippi River, warnings are given some weeks before the crest arrives, with an error of only a few hours in time of arrival and of a few inches in the heights reached.

The flood warnings enable people to escape from the danger zones, to remove livestock and other property, and to take various precautionary and protective measures. It is certain that they result in the saving of property worth many times the cost of the service. The forecasts and data are promptly given to the public by daily river bulletins published at the river district centers and by all other available means of distribution. In cases where it is found practicable and valuable, forecasts of ice formation and movement are made, and general information in regard to ice in rivers is published. For the river work, mountain-snowfall stations are maintained in western mountain regions to obtain records of the accumulated depth of snow, for use in investigational work and forecasting run-off.

Hydrologic service.—In addition to its river and flood service, the Weather Bureau has recently established a special *hydrologic unit* for the purpose of obtaining more detailed quantitative and intensity data on precipitation, particularly for flood control uses. Besides making use of the rainfall records from all the first-order and subsidiary stations, it has established about a thousand additional stations with recording rain gages and as many more with non-recording gages. All available data are assembled and tabulated by regions corresponding with drainage areas.

Daily amounts are tabulated for all stations, hourly amounts for stations with recording gages, and storm-period amounts by hours for the important storms. The information is made available to the U. S. Engineer Corps, the Soil Conservation Service, the Forest Service, and other agencies interested in floods, erosion, and other hydrologic problems.

Evaporation observations.—About 40 evaporation stations are maintained in various parts of the country, for the measurement of the amount of evaporation of water from shallow pans, as described on page 56. The daily and monthly amounts of evaporation, thus obtained, together with the daily temperatures and wind movements at the same location, are published in the *Climatological Data* bulletins of the various sections. The data are valuable for many hydrological and ecological studies.

Solar radiation investigations.—From the measurements of the intensity of solar radiation and of sky brightness, mentioned on page 90, compilations are made of daily and annual variations in radiation in different parts of the United States. These compilations give information relative to the heating and lighting effects of solar and sky radiation in different parts of the country and their relation to the vapor content of the air and to geographic location and altitude.

Publications.—Many of the publications of the Weather Bureau issued for the dissemination of forecasts and current information have been mentioned. These include daily weather maps, weather cards or bulletins, forecast cards, weather and crop bulletins, river bulletins, a monthly meteorological summary, and, in many cases, a local annual summary at first-order stations, and the monthly and annual bulletins of *Climatological Data*. In addition, the accumulated climatic data are summarized in a series of bulletins under the name of *Climatic Summary of the United States by Sections*. These sections are not the same as the state climatological sections but are 106 in number, averaging more than 2 for each state. These publications contain rather complete summaries of temperature, rainfall,

and frost data, and are revised and brought up to date from time to time. All available observations from regular stations and substations, from the first taking of records to the time of closing for publication, are used. These summaries are a valuable and much used primary source of climatic information. The annual reports of the Chief of the Weather Bureau, since 1935 published as the *United States Meteorological Yearbooks*, contain summaries of the observations at all first-order stations and reports on hail, tornadoes, and windstorms. These are a valuable source of climatic data. Pamphlets and circulars are published, giving descriptions of meteorological instruments used by the Bureau and instructions for their care and management.

The *Monthly Weather Review* is a meteorological magazine published since 1872, first by the Signal Service and then by the Weather Bureau. In addition to tables and discussions of the weather of the month, it contains original contributions of a more or less technical character. From time to time, reports or investigations too long to be published in the *Monthly Weather Review* are now printed as numbered supplements of the *Review*. In previous years, studies of this character appeared in independent pamphlets, of which about 100 have been issued, including those published by the Signal Service. In 1916 the Weather Bureau published *Weather Forecasting in the United States*, a book, prepared by forecasters and other officials of the Bureau, which contains a discussion of the general principles and some of the more specific precepts of weather forecasting as then practiced in this country. The more recent developments in weather forecasting are summarized in an official pamphlet, *Forecasting from Synoptic Weather Charts*, written by R. H. Weightman, and published in April, 1936.

Coöperation.—An outstanding feature of the work of the Weather Bureau is the extent of its coöperative activity. It works with many other agencies, both public and private, in the collection and distribution of meteorological and cli-

matological data. Weather data are essential to many other agencies, and this combining of effort makes for efficiency and is mutually advantageous. In the forecast and warning service, Army and Navy radio stations aid in the collection of reports and the broadcasting of information, and newspapers, broadcasting stations, and telephone companies are essential in the prompt distribution of weather news. The important role played by coöperative observers in the collection of climatological data has been mentioned, and the marine work is largely dependent on the coöperation of shipmasters.

The fruit-frost work of the Weather Bureau has the active assistance of the fruit growers and their associations, and they share the expense of this service. The fire-weather work is carried on in association with the Forest Service, whose employees act as observers. The Forest Service also aids in the collection of mountain-snowfall data, the data being useful in the conduct of their work as well as for other purposes. The Army and Navy Departments contribute to current knowledge of upper air conditions by making daily airplane observation flights at a number of their flying fields. Along the principal airways of the country there is close and effective coöperation in the observation and communication work between the Weather Bureau and the Civil Aeronautics Administration; and the air transport companies, chiefly through their pilots, furnish, as well as receive, valuable information. River-gage readings are of importance in the work of the U. S. Engineer Corps and the U. S. Geological Survey, and these two organizations cooperate with the Weather Bureau in the installation and maintenance of river gages. In many cases the Weather Bureau works with other governmental and nongovernmental agencies to their mutual advantage, resulting in increased efficiency and decreased cost of service.

Internationally, the science of meteorology affords one of the finest existing examples of friendly coöperation among nations. Since the weather knows no national boundaries,

the needs of meteorology require that methods of observation and publication be on a comparable basis throughout the world. This has long been recognized by meteorologists, and ever since 1879 there has existed a wholly voluntary unofficial commission, known as the International Meteorological Organization, and composed of the directors of all the large national meteorological services. The organization meets every 6 years for the discussion of common problems, especially the problems connected with the international exchange of weather data, involving the standardization of observations, definitions, symbols, and codes of transmission. The parent Organization appoints subcommissions of its own members and other meteorologists for investigations and reports concerning specific aspects of meteorological work and coöperation.

The resolutions and reports of the Organization and its subcommissions are not binding on the several countries but are widely adopted because of the recognized advantage of coördinated action. The reports of the International Cloud Commission, which is a subcommission of the larger Organization, have served to standardize the definitions and descriptions of cloud forms throughout the world. By international coöperation many special observations were obtained in the Northern Hemisphere, especially in Arctic regions, during what is known as the second International Polar Year, which covered the period from August 1, 1932, to August 31, 1933.

Exchange of daily observations has reached considerable proportions throughout the world, and progress is being made toward the prompt distribution of monthly mean values of pressure, temperature, and precipitation. There is a high degree of coöperation between the United States and Canada, with prompt exchange of daily telegraphic reports across the border in both directions. The United States has exchange arrangements also with Mexico, the West Indies, the Philippines, and the Far East. Twice each day, at 11 A.M. and 11 P.M., Eastern standard time, bulletins

containing about 100 North American reports and also reports from ships in the western Atlantic are broadcast from the Weather Bureau office in Washington through Navy radio stations, for the benefit of European meteorological services. At about 5 A.M. and 5 P.M., Eastern standard time, reports from about 100 European land stations and from ships in the eastern Atlantic are broadcast from England for the information of American meteorologists.

In time of war, current weather information and weather forecasts are of great value in planning and executing military activities. Hence, when nations are at war, each country makes intensive use of its meteorological observations and forecasts for the benefit of its own army, navy, and air forces, but closely guards the information and restricts its dissemination in order to prevent its use by the enemy.

Summary

Weather observations and weather forecasting began in this country, as in some other countries, by private enterprise. Later, it became evident that the nature of the work and the universal value of the data demanded a nationwide governmental organization. The official meteorological service of the United States began in 1870 under the Signal Service of the U. S. Army, and was transferred in 1891 to the Weather Bureau of the Department of Agriculture.

The present organization of the Weather Bureau consists of a central administrative and professional office at Washington, D. C., 5 additional district forecast centers, 45 section centers for the collection and publication of climatological data, and numerous major airport stations, weather and crop centers, river and flood districts, and centers for preparing and distributing frost warnings, and fire-weather warnings. In addition, there are about 5,000 local stations and substations of various grades and functions.

This extensive organization conducts a large range of activities, all connected with the weather, and mostly included in the general functions of recording weather condi-

tions as they occur, forecasting future weather, determining in detail the climatic characteristics of the United States, and, finally, of disseminating all this information promptly to the interested public. The public is interested, because weather conditions affect the comfort, convenience, and work of every family in the country. These services are, therefore, indispensable, and in performing them the Weather Bureau's efficient organization makes a very large economic return to the country, for the money expended upon it.

APPENDIX I

Bibliography

The following brief list of publications in English contains only such titles as are of value for supplementary reading or for reference in connection with the use of this textbook. The general elementary treatises should be used freely as collateral reading but with discrimination, since some of them contain statements and theories not generally accepted, and some do not include the newer developments of the subject. The publications marked with an asterisk have been found especially valuable and usable in connection with an introductory course.

General Elementary Treatises

- Albright, J. G., *Physical Meteorology*, Prentice-Hall, Inc., New York, 1939.
- Brooks, C. F., *Why the Weather?* 2nd ed., Harcourt, Brace & Co., New York, 1935.
- *Brunt, David, *Meteorology*, Oxford University Press, London, 1928.
- Byers, H. R., *Synoptic and Aeronautical Meteorology*, McGraw-Hill Book Co., New York, 1937.
- *Davis, W. M., *Elementary Meteorology*, Ginn & Co., Boston, 1894.
- Geddes, A. E. M., *Meteorology*, D. Van Nostrand Co., New York, 1930.
- Great Britain Meteorological Office, *The Weather Map; an Introduction to Modern Meteorology*, 2nd ed., London, 1930.
- *Milham, W. I., *Meteorology*, The Macmillan Company, New York, 1910.
- Pettterssen, S., *Introduction to Meteorology*, McGraw-Hill Book Co., New York, 1941.
- *Pick, W. H., *Short Course in Elementary Meteorology*, 4th ed., Great Britain Meteorological Office, London, 1933.
- Shaw, Sir Napier, *Manual of Meteorology*, Vol. I—*Meteorology in History*, 1926; Vol. II—*Comparative Meteorology*, 1928; Cambridge University Press, London, and The Macmillan Company, New York.

- *Talman, C. F., *A Book about the Weather* (previously published as *The Realm of the Air*), New York, 1935.
- Taylor, G. F., *Aeronautical Meteorology*, Pitman Publishing Corp., New York, 1938.
- Trewartha, G. T., *Introduction to Weather and Climate*, McGraw-Hill Book Co., New York, 1937.

Advanced Treatises Involving Considerable Physics and Mathematics

- Brunt, David, *Physical and Dynamical Meteorology*, Cambridge University Press, 1934.
- Haurwitz, B., *Dynamic Meteorology*, McGraw-Hill Book Co., New York, 1941.
- Humphreys, W. J., *Physics of the Air*, 3rd ed., McGraw-Hill Book Company, New York, 1940.
- Pettterssen, S., *Weather Analysis and Forecasting*, McGraw-Hill Book Co., New York, 1940.
- Shaw, Sir Napier, *Manual of Meteorology*, Vol. III—*The Physical Processes of Weather*, 1930; Vol. IV—*Meteorological Calculus: Pressure and Wind*, 1932, Cambridge University Press and The Macmillan Company, New York.

Air-Mass Analysis

- Douglas, C. K. M., "Physical Process of Cloud Formation," *Quar. Jour., Royal Met'l Soc.*, Vol. 60, 1934, pp. 333-341.
- Douglas, C. K. M., "The Problem of Rainfall," *Quar. Jour., Royal Met'l Soc.*, Vol. 60, 1934, pp. 143-152.
- Gold, E., "Fronts and Occlusions," *Quar. Jour., Royal Met'l Soc.*, Vol. 61, 1935, pp. 107-157.
- Namias, Jerome, and others, *Air Mass and Isentropic Analysis*, 5th ed., Amer. Met'l Soc., Milton, Mass., 1940.
- Rosby, C.-G., "Thermodynamics Applied to Air Mass Analysis," *Meteorological Papers*, Vol. I, No. 3, Mass. Inst. of Tech., Boston, 1932.
- Rosby, C.-G., and Weightman, R. H., "Application of the Polar Front Theory to a Series of American Weather Maps," *Mo. Wea. Rev.*, Vol. 54, 1926, pp. 485-496.
- Willett, H. C., *Dynamic Meteorology*, Bulletin 79, National Research Council, Washington, 1931, pp. 133-233.

Books on Various Subdivisions of Meteorology

- Bentley, W. A., and Humphreys, W. J., *Snow Crystals* (contains over 2,000 microphotographs of snow crystals and kindred

- forms of water), McGraw-Hill Book Company, New York, 1931.
- Clark, G. A., *Clouds*, Constable & Co., London, 1920.
- Clayton, H. H., *World Weather*, The Macmillan Company, New York, 1923.
- Cline, I. M., *Tropical Cyclones*, The Macmillan Company, New York, 1926.
- Great Britain Meteorological Office, *Meteorological Glossary*, 2nd ed., London, 1930.
- Haynes, B. C., *Meteorology for Pilots*, Civil Aeronautics Bul., No. 25, Government Printing Office, Washington, 1940.
- Humphreys, W. J., *Fogs and Clouds*, Williams & Wilkins Co., Baltimore, 1926.
- Humphreys, W. J., *Rain Making and Other Weather Vagaries*, Williams & Wilkins Co., Baltimore, 1934.
- Humphreys, W. J., *Weather Proverbs and Paradoxes*, 2nd ed., Williams & Wilkins Co., Baltimore, 1934.
- Middleton, W. E. K., *Meteorological Instruments*, Univ. of Toronto Press, Toronto, 1941.
- Shaw, Sir Napier, *The Drama of the Weather*, Cambridge University Press, 1933.
- Shaw, Sir Napier, *Forecasting Weather*, 2nd ed., Constable & Co., London, 1923.
- Smith, J. W., *Agricultural Meteorology*, The Macmillan Company, New York, 1920.
- Sutcliffe, R. C., *Meteorology for Aviators*, Meteorological Office, Air Ministry, London, 1940.
- Tannehill, I. R., *Hurricanes: Their Nature and History*, Princeton Univ. Press, Princeton, 1939.
- U. S. Department of Agriculture, *Climate and Man, Yearbook, 1941*, Government Printing Office, Washington, 1941.

Bulletins, Pamphlets, and Articles

- Alexander, W. H., "Distribution of Thunderstorms in the United States," *Mo. Wea. Rev.*, Vol. 63, 1935, pp. 157-158.
- Blair, T. A., "Local Forecast Studies—Summer Rainfall," *Mo. Wea. Rev.*, Vol. 49, 1921, pp. 183-190.
- Blair, T. A., "Local Forecast Studies—Winter Precipitation," *Mo. Wea. Rev.*, Vol. 52, 1924, pp. 79-85.
- Blair, T. A., "Weather Types and Pressure Anomalies," *Mo. Wea. Rev.*, Vol. 61, 1933, pp. 196-197.
- Blair, T. A., and Topil, A. G., "Relation of Seasonal Temperatures in the Missouri and Upper Mississippi Valleys to

- Antecedent Pressure Departures in Other Regions," *Mo. Wea. Rev.*, Vol. 63, 1935, pp. 159-161.
- Bowie, E. H., and Weightman, R. H., "Types of Storms of the United States and Their Average Movements," *Mo. Wea. Rev.*, Supplement No. 1, Washington, 1914.
- Bowie, E. H., and Weightman, R. H., "Types of Anticyclones of the United States and Their Average Movements," *Mo. Wea. Rev.*, Supplement No. 4, Washington, 1917.
- Brooks, C. F., "The Local, or Heat, Thunderstorm," *Mo. Wea. Rev.*, Vol. 50, 1922, pp. 281-284.
- Covert, R. N., *Protection of Buildings and Farm Property from Lightning*, 2nd ed., Farmers' Bulletin 1512, United States Dept. of Agriculture, 1930.
- Dines, W. H., "The Heat Balance of the Atmosphere," *Quar. Jour., Royal Met'l Soc.*, Vol. 43, 1917, pp. 151-158.
- Hallenbeck, Cleve, "The Topographic Thunderstorm," *Mo. Wea. Rev.*, Vol. 50, 1922, pp. 284-287.
- International Meteorological Committee, *International Atlas of Clouds and of States of the Sky*, Abridged ed., 1930; Complete ed., 1932; *Office National Météorologique*, Paris.
- Kimball, H. H., "Duration and Intensity of Twilight," *Mo. Wea. Rev.*, Vol. 44, 1916, pp. 614-620.
- Kincer, J. B., "Is Our Climate Changing? A Study of Long-time Temperature Trends," *Mo. Wea. Rev.*, Vol. 61, 1933, pp. 251-259.
- Kincer, J. B., "Weather and Cotton Production," *Mo. Wea. Rev.*, Vol. 58, 1930, pp. 190-196.
- McEwen, G. F., "Methods of Seasonal Weather Forecasting at the Scripps Institution of Oceanography," *Bulletin, American Met'l Soc.*, Vol. 15, 1934, pp. 249-256.
- Marvin, C. F., "Elementary Notes on Least Squares, the Theory of Statistics and Correlation for Meteorology and Agriculture," *Mo. Wea. Rev.*, Vol. 44, 1916, pp. 551-569.
- Mitchell, C. L., "West Indian Hurricanes and Other Tropical Cyclones of the North Atlantic Ocean," *Mo. Wea. Rev.*, Supplement No. 24, Washington, 1924.
- Montgomery, R. B., and others, "Critical Studies of Methods of Long-range Weather Forecasting," *Mo. Wea. Rev.*, Supplement No. 39, Washington, 1940.
- Simpson, G. C., "On the Formation of Cloud and Rain," *Quarterly Journal, Royal Met'l Soc.*, Vol. 67, 1941, pp. 99-133.
- Weightman, R. H., *Forecasting from Synoptic Weather Charts*, Misc. publication, No. 236, U. S. Dept. of Agriculture, Washington, 1936.

- Weightman, R. H., "Preliminary Studies in Seasonal Weather Forecasting," *Mo. Wea. Rev., Supplement*, No. 45, Washington, 1941.
- Willett, H. C., "Fog and Haze: Their Causes, Distribution, and Forecasting," *Mo. Wea. Rev.*, Vol. 56, 1928, pp. 435-468.
- Young, F. D., *Frost and the Prevention of Frost Damage*, Farmers' Bulletin, No. 1588, U. S. Dept. of Agriculture, Washington, 1929.

Climatology

- Brooks, C. E. P., *The Evolution of Climate*, 2nd ed., Ernest Benn, Ltd., London, 1925.
- Hann, J., and Ward, R. DeC., *Handbook of Climatology*, The Macmillan Company, New York, 1903.
- Kendrew, W. G., *Climate*, Oxford University Press, 1930.
- Landsberg, H., *Physical Climatology*, Penn. State College, State College, Penn., 1941.
- Miller, A. A., *Climatology*, Methuen, Ltd., London, 1931.
- Ward, R. DeC., *Climate, Considered Especially in Relation to Man*, G. P. Putnam's Sons, New York, 1918.

Climatic Data and Maps

- Annual Reports of Chief of Weather Bureau, U. S. Weather Bureau, Washington.
- Atlas of American Agriculture*, U. S. Dept. of Agriculture, Office of Farm Management.
- Part II. Climate.
- Sect. 1. Reed, W. G., "Frost and the Growing Season," 1918.
- Sect. A. Kincer, J. B., "Precipitation and Humidity," 1922.
- Sect. B. Kincer, J. B., "Temperature, Sunshine and Wind," 1928.
- Atlas of Meteorology, Bartholomew's Physical Atlas*, Vol. III, J. B. Lippincott Co., Philadelphia, 1899.
- Brooks, C. F., Connor, A. J., and others, *Climatic Maps of North America*, 26 maps, Harvard University Press, Cambridge, Mass., 1936.
- Clayton, H. H., *World Weather Records*, Smithsonian Misc. Collections, Vol. 79, 1927, and Vol. 90, 1934, Smithsonian Institution, Washington.
- Climatic Summary of the United States by Sections* (In separate bulletins, nos. 1-106. Bulletins for any state obtainable from Section Director for that state).

- Climatological Data by States* (Monthly and annual bulletins obtainable from Section Director).
- Henry, A. J., *Climatology of the United States*, Bulletin Q., U. S. Weather Bureau, Washington, 1906.
- Kendrew, W. G., *The Climates of the Continents*, Clarendon Press, Oxford, 1932.
- U. S. Weather Bureau, "Normals of Daily Temperature for the U. S.; Period 1875-1921," *Mo. Wea. Rev.*, Supplement No. 25, Washington, 1925.
- U. S. Weather Bureau, "Daily, Monthly and Annual Normals of Precipitation in the U. S.; Period 1878-1927," *Mo. Wea. Rev.*, Supplement No. 34, Washington, 1930.
- Ward, R. DeC., *The Climates of the United States*, Ginn & Company, Boston, 1925.

Miscellaneous Publications of the U. S. Weather Bureau

Obtainable from the Superintendent of Documents, Government Printing Office, Washington, D. C.

Circulars.—A. Instructions for obtaining and tabulating records from recording instruments. B. and C., combined. Instructions for coöperative observers. D. Instructions for the installation and maintenance of wind-measuring and -recording apparatus. E. Measurement of precipitation. F. Barometers and the measurement of atmospheric pressure. G. Care and management of electrical sunshine recorders. I. Instructions for erecting and using Weather Bureau nephoscope. L. Instructions for the installation and operation of class A evaporation stations. M. Instructions to marine meteorological observers. N. Instructions for airway meteorological service. O. Instructions for making pilot balloon observations. P. Instructions for making aerological observations. Q. Pyrheliometers and pyrheliometric observations. R. Preparation and use of weather maps at sea.

Climatic Charts for the United States.—12 charts, 10 × 16 inches.

Cloud Forms.—With 32 half-tone plates and descriptive pamphlet.

Daily Weather Map.—Issued at Washington (Map C, 19 × 24 inches).

Frost Charts for the United States.—5 charts, 10 × 16 inches.

Psychrometric Tables.—For the computation of dew point, relative humidity, and vapor pressure.

APPENDIX II

Conversion Factors and Tables

Abridged from Smithsonian Meteorological Tables, Fifth Edition, 1931.

Equivalent Values

1 foot = 0.3048 meter.

1 meter = 39.37 inches = 3.2808 feet.

1 mile = 1.6093 kilometers.

1 kilometer = 3280.8 feet = 0.62137 mile.

1 inch, mercury = 25.4 millimeters = 33.86395 millibars.

1 millimeter, mercury = 0.03937 inch = 1.3332 millibars.

1 millibar = 0.02953 inch = 0.75006 millimeter.

1 mile per hour = 0.447 meter per second.

1 meter per second = 2.237 miles per hour.

TEMPERATURE EQUATIONS

$$F = 9/5 C + 32 = 9/5 (A - 273) + 32.$$

$$C = 5/9 (F - 32) = A - 273.$$

$$A = 5/9 (F - 32) + 273 = C + 273.$$

TABLE I
INCHES OF MERCURY INTO MILLIBARS

In.	Millibars									
	0	.1	.2	.3	.4	.5	.6	.7	.8	.9
25	847	850	853	857	860	864	867	870	874	877
26	880	884	887	891	894	897	901	904	908	911
27	914	918	921	924	928	931	935	938	941	945
28	948	952	955	958	962	965	968	972	975	979
29	982	985	989	992	996	999	1002	1006	1009	1013
30	1016	1019	1023	1026	1030	1033	1036	1040	1043	1046
31	1050	1053	1057	1060	1063	1067	1070	1074	1077	1080

TABLE II
MILLIBARS INTO INCHES

Millibars	Inches					
	0	5	10	15	20	25
860	25.40	25.54	25.69	25.84	25.99	26.13
890	26.28	26.43	26.58	26.72	26.87	27.02
920	27.17	27.32	27.46	27.61	27.76	27.91
950	28.05	28.20	28.35	28.50	28.64	28.79
980	28.94	29.09	29.23	29.38	29.53	29.68
1010	29.83	29.97	30.12	30.27	30.42	30.56
1040	30.71	30.86	31.01	31.15	31.30	31.45

TABLE III
FAHRENHEIT SCALE TO CENTIGRADE

°F	Centigrade									
	0	1	2	3	4	5	6	7	8	9
-60	-51.1	-51.7	-52.2	-52.8	-53.3	-53.9	-54.4	-55.0	-55.6	-56.1
-50	-45.6	-46.1	-46.7	-47.2	-47.8	-48.3	-48.9	-49.4	-50.0	-50.6
-40	-40.0	-40.6	-41.1	-41.7	-42.2	-42.8	-43.3	-43.9	-44.4	-45.0
-30	-34.4	-35.0	-35.6	-36.1	-36.7	-37.2	-37.8	-38.3	-38.9	-39.4
-20	-28.9	-29.4	-30.0	-30.6	-31.1	-31.7	-32.2	-32.8	-33.3	-33.9
-10	-23.3	-23.9	-24.4	-25.0	-25.6	-26.1	-26.7	-27.2	-27.8	-28.3
0	-17.8	-18.3	-18.9	-19.4	-20.0	-20.6	-21.1	-21.7	-22.2	-22.8
+0	-17.8	-17.2	-16.7	-16.1	-15.6	-15.0	-14.4	-13.9	-13.3	-12.8
10	-12.2	-11.7	-11.1	-10.6	-10.0	-9.4	-8.9	-8.3	-7.8	-7.2
20	-6.7	-6.1	-5.6	-5.0	-4.4	-3.9	-3.3	-2.8	-2.2	-1.7
30	-1.1	-0.6	0.0	0.6	1.1	1.7	2.2	2.8	3.3	3.9
40	4.4	5.0	5.6	6.1	6.7	7.2	7.8	8.3	8.9	9.4
50	10.0	10.6	11.1	11.7	12.2	12.8	13.3	13.9	14.4	15.0
60	15.6	16.1	16.7	17.2	17.8	18.3	18.9	19.4	20.0	20.6
70	21.1	21.7	22.2	22.8	23.3	23.9	24.4	25.0	25.6	26.1
80	26.7	27.2	27.8	28.3	28.9	29.4	30.0	30.6	31.1	31.7
90	32.2	32.8	33.3	33.9	34.4	35.0	35.6	36.1	36.7	37.2
100	37.8	38.3	38.9	39.4	40.0	40.6	41.1	41.7	42.2	42.8
110	43.3	43.9	44.4	45.0	45.6	46.1	46.7	47.2	47.8	48.3

TABLE IV
CENTIGRADE SCALE TO FAHRENHEIT

°C	Fahrenheit									
	0	1	2	3	4	5	6	7	8	9
-50	-58.0	-59.8	-61.6	-63.4	-65.2	-67.0	-68.8	-70.6	-72.4	-74.2
-40	-40.0	-41.8	-43.6	-45.4	-47.2	-49.0	-50.8	-52.6	-54.4	-56.2
-30	-22.0	-23.8	-25.6	-27.4	-29.2	-31.0	-32.8	-34.6	-36.4	-38.2
-20	-4.0	-5.8	-7.6	-9.4	-11.2	-13.0	-14.8	-16.6	-18.4	-20.2
-10	14.0	12.2	10.4	8.6	6.8	5.0	3.2	1.4	0.4	-2.2*
0	32.0	30.2	28.4	26.6	24.8	23.0	21.2	19.4	17.6	15.8
+10	50.0	51.8	53.6	55.4	57.2	59.0	60.8	62.6	64.4	66.2
20	68.0	69.8	71.6	73.4	75.2	77.0	78.8	80.6	82.4	84.2
30	86.0	87.8	89.6	91.4	93.2	95.0	96.8	98.6	100.4	102.2
40	104.0	105.8	107.6	109.4	111.2	113.0	114.8	116.6	118.4	120.2

APPENDIX III

Mean Monthly and Annual Temperatures and Precipitation

TABLE V
MEAN TEMPERATURE, ° F.

Stations	Jan.	Feb.	Mar.	April	May	June	July	Aug.	Sept.	Oct.	Nov.	Dec.	Annual
United States.....	44.2	47.2	56.5	64.4	72.0	79.2	82.8	82.0	75.3	65.4	53.5	46.0	64.0
Albany.....	7.8	10.3	24.2	42.1	54.5	63.7	69.8	67.3	58.1	44.9	28.5	14.7	40.5
Bismarck.....	29.8	34.8	42.7	50.4	57.1	65.3	71.8	71.8	61.9	51.1	41.0	32.1	50.9
Boston.....	27.9	28.8	35.6	46.4	57.1	66.5	71.7	69.9	63.2	53.6	42.0	32.5	49.6
Burlington.....	18.8	19.4	29.1	43.3	56.5	65.7	70.3	67.9	60.3	49.2	36.3	24.4	45.1
Charleston.....	49.9	52.4	57.4	61.5	72.7	78.9	81.4	81.0	76.6	67.8	58.1	51.7	66.0
Chicago.....	25.1	27.4	36.3	47.7	58.5	68.2	73.9	72.8	66.3	55.1	41.2	30.0	50.2
Columbus.....	28.6	30.7	39.1	51.2	62.3	70.9	74.9	73.0	66.5	55.2	41.9	32.4	52.2
Denver.....	29.8	32.7	39.3	47.1	56.2	66.3	73.9	70.7	62.9	51.2	39.8	32.3	50.0
Des Moines.....	20.1	23.7	33.9	50.1	61.3	70.6	75.4	73.1	65.6	53.4	38.4	26.0	49.5
Detroit.....	24.4	25.3	33.4	46.2	58.0	67.4	72.1	70.3	63.5	52.5	39.3	29.3	48.5
Dodge City.....	29.0	33.2	42.8	53.6	63.5	72.5	78.4	77.7	69.4	56.1	42.6	32.6	54.3
Helena.....	23.0	23.0	32.4	43.5	51.6	59.2	65.7	65.0	56.6	44.9	33.2	24.2	43.3
Huron.....	11.3	14.3	23.9	45.1	56.4	66.2	71.8	69.4	61.3	47.7	33.2	24.2	43.3
Jacksonville.....	55.4	60.0	62.0	68.7	73.0	73.9	73.9	81.7	78.3	71.1	63.2	53.3	69.3
Kansas City.....	28.2	31.7	42.7	53.8	64.9	73.5	78.5	76.6	68.9	57.7	43.7	32.5	54.4
Lander.....	18.3	22.5	32.4	42.1	52.3	60.3	67.4	70.6	74.1	63.5	50.3	40.4	62.0
Little Rock.....	51.4	53.9	57.0	62.1	69.2	74.4	79.9	78.1	78.1	65.9	52.1	44.2	62.0
Los Angeles.....	54.4	57.5	61.5	68.4	76.4	80.0	81.0	77.0	79.9	65.3	52.1	44.2	62.0
Louisville.....	34.4	37.2	45.5	58.4	66.5	74.4	78.6	77.0	70.0	59.3	49.4	36.0	57.0
Miami.....	66.5	67.1	70.3	72.8	76.4	80.0	81.0	81.0	80.1	77.0	70.8	66.0	74.4
Minneapolis.....	15.0	19.2	29.8	46.1	57.7	67.5	72.3	69.8	61.4	48.9	32.8	19.6	44.4
Montgomery.....	48.2	51.6	57.8	63.3	73.4	79.6	81.7	80.8	76.3	66.6	55.8	49.4	65.2
Nashville.....	38.6	41.6	49.2	59.0	68.2	75.6	79.1	77.8	70.2	61.0	49.0	41.0	59.3
New Orleans.....	30.9	31.3	37.7	48.4	60.6	68.8	73.8	73.1	66.8	56.3	41.2	35.6	69.3
New York.....	36.4	39.6	50.0	59.8	67.7	76.0	80.6	79.7	72.8	61.5	48.8	39.3	59.4
Oklahoma City.....	21.9	25.5	37.0	51.2	62.4	71.6	78.4	74.4	66.8	54.3	38.5	26.4	50.6
Omaha.....	51.2	55.1	60.7	67.0	75.0	81.5	89.8	88.5	82.7	70.6	59.7	52.0	69.7
Pittsburgh.....	30.7	32.3	39.6	51.2	62.4	70.7	74.6	73.9	66.4	55.7	43.2	34.2	52.8
Portland, Me.....	22.4	23.8	31.8	43.0	53.3	62.5	68.1	66.4	59.6	49.9	38.0	27.6	45.5
Portland, Ore.....	39.4	42.1	46.9	51.8	58.5	62.4	66.7	66.7	61.7	54.2	46.8	41.0	53.1
Raleigh.....	41.1	45.2	50.2	59.4	68.5	75.7	78.8	77.0	71.1	62.0	51.0	43.0	60.1
Rochester.....	24.6	24.6	31.8	44.9	57.1	66.1	70.7	69.2	62.4	51.5	38.7	29.3	47.6
St. Louis.....	31.1	34.8	44.1	56.1	67.4	75.0	78.8	77.5	70.5	58.8	45.4	34.9	56.2
Salt Lake City.....	29.2	33.8	41.7	49.6	57.4	67.4	75.7	74.5	64.4	52.5	41.1	31.9	51.6

San Diego.....	54.3	55.1	56.7	58.5	60.8	63.9	67.2	68.7	67.1	63.7	59.7	56.0	61.0
San Francisco.....	49.9	52.2	54.2	56.7	58.8	58.5	58.5	60.9	60.0	60.0	60.5	56.3	48.5
Santa Fe.....	32.1	33.2	39.7	46.7	55.7	64.8	69.0	67.4	60.9	60.9	60.4	38.9	39.2
Saville St. Marie.....	13.3	12.0	21.6	37.4	49.0	56.0	63.8	62.1	55.9	55.9	32.0	20.7	30.2
Seattle.....	79.5	41.9	44.9	48.4	54.0	59.0	63.1	62.1	58.1	58.1	51.4	41.7	39.2
Spokane.....	27.5	31.5	39.7	48.4	57.2	62.8	69.0	68.1	68.2	68.2	48.3	30.0	35.0
Washington, D. C.....	33.4	35.3	42.6	53.5	65.9	72.2	76.8	79.3	88.1	88.1	38.3	30.3	48.2
Winnemucca.....	28.6	33.8	40.0	46.7	53.9	62.8	70.6	69.3	68.1	59.2	48.3	36.9	45.4
Honolulu.....	70.9	70.8	71.4	73.0	74.8	76.6	77.7	78.4	78.2	76.8	74.5	72.4	74.6
Juneau.....	26.7	30.0	33.5	40.8	48.0	54.2	57.4	55.0	50.2	42.9	34.8	31.0	42.0
Nome.....	1.3	5.8	8.2	17.2	34.3	44.7	50.1	49.5	41.2	28.9	14.3	6.2	22.1
San Juan.....	75.0	74.9	75.4	76.6	78.6	79.7	80.1	80.5	80.5	79.8	78.4	76.3	78.0
North America (except United States and Central America)													
Calgary.....	11.3	14.5	25.1	39.9	48.9	55.9	60.7	58.7	50.5	41.9	26.4	20.5	37.8
Kamloops.....	22.4	26.5	37.6	49.7	57.5	64.6	69.6	68.1	58.4	47.8	35.8	28.8	47.2
Quebec.....	10.1	11.7	23.0	37.1	51.5	61.2	66.3	63.0	55.4	43.0	29.8	15.4	38.1
St. Johns.....	24.2	23.3	28.5	35.4	42.7	49.7	58.9	59.3	53.7	45.4	37.6	28.9	40.1
Toronto.....	22.9	21.1	30.2	43.1	53.6	64.6	69.1	67.2	60.8	48.3	37.4	27.7	34.8
Winnipeg.....	-3.5	-0.5	15.2	38.7	51.5	62.6	66.2	62.7	54.1	41.6	22.0	7.2	34.8
Colon.....	79.5	79.2	79.7	79.9	79.9	78.9	80.1	79.3	79.5	79.0	79.9	79.5	79.5
Guatemala.....	61.3	62.8	65.7	66.2	68.0	66.2	65.8	66.0	65.7	64.8	62.8	61.3	64.8
Havana.....	70.3	72.0	73.4	72.0	79.2	81.3	81.9	81.5	80.4	77.9	74.7	71.6	76.6
Mexico City.....	54.0	56.8	60.4	64.0	64.9	63.9	62.4	62.1	61.2	58.6	56.5	53.4	59.9
South America													
Buenos Aires.....	73.6	73.0	69.6	61.9	55.9	51.1	50.2	52.3	57.1	61.0	67.3	71.4	61.9
Lima.....	71.1	73.4	77.0	70.0	66.0	62.1	60.6	60.6	61.3	61.9	65.8	69.8	66.2
Para.....	77.7	77.0	77.5	77.0	78.3	78.3	78.1	78.8	78.6	79.7	79.7	79.0	78.3
Quito.....	54.5	55.0	54.5	54.5	54.9	54.9	54.9	54.9	55.0	54.7	54.3	54.7	54.3
Rio de Janeiro.....	77.5	78.1	77.2	74.1	70.7	68.2	67.5	68.7	69.4	71.2	73.4	74.8	72.5
Santiago.....	67.3	66.0	61.9	56.1	50.5	46.0	46.0	48.2	52.2	56.1	61.0	65.7	56.4
Europe													
Athens.....	46.4	47.5	52.3	58.8	67.8	75.7	80.6	79.0	73.9	66.2	57.0	50.0	63.0
Belgrade.....	29.1	32.8	37.0	45.0	54.6	62.1	71.6	70.5	63.3	55.2	42.6	34.2	52.0
Berlin.....	40.8	39.5	39.0	45.0	51.9	62.1	73.2	72.3	67.0	68.2	58.1	42.7	47.8
Constantinople.....	40.6	41.0	43.7	52.2	61.0	73.2	80.6	78.3	69.3	61.3	52.5	32.7	46.3
Copenhagen.....	32.2	31.8	34.5	41.7	50.7	61.9	73.2	73.2	67.3	67.3	58.1	45.9	40.8
Dublin.....	32.1	32.5	40.8	47.0	57.1	68.1	80.1	80.0	69.2	60.2	49.1	34.5	48.9
Geneva.....	38.6	38.6	43.6	48.9	57.8	67.8	77.1	74.8	64.9	49.1	40.8	32.7	45.9
London.....	39.7	40.1	42.4	52.3	63.4	74.8	82.7	81.6	66.4	57.1	47.1	40.1	49.7
Madrid.....	38.9	43.9	47.5	54.7	64.1	74.8	82.7	81.6	66.0	58.1	47.1	44.1	58.8
Marseilles.....	43.3	45.3	48.6	54.7	64.1	74.8	82.7	81.6	66.0	58.1	47.1	44.1	58.8
Moscow.....	12.2	14.7	23.4	38.3	53.1	67.0	72.1	71.1	62.8	39.7	27.9	17.2	38.0
Odessa.....	25.3	27.7	34.9	50.5	65.2	88.0	92.7	70.9	59.0	59.0	41.8	30.6	50.5
Paris.....	36.5	39.0	43.2	50.5	56.1	62.4	75.5	64.4	52.0	50.5	42.8	37.2	49.3

TABLE VI
MEAN PRECIPITATION, INCHES

Stations	Jan.	Feb.	Mar.	April	May	June	July	Aug.	Sept.	Oct.	Nov.	Dec.	Annual
United States	0.96	1.01	1.29	2.71	3.96	2.99	2.12	2.24	2.70	2.50	1.55	1.34	25.17
Albany	0.45	0.44	0.89	1.52	2.32	3.35	0.24	1.82	1.23	0.94	0.57	0.57	16.34
Bismarck	0.73	0.44	1.35	1.18	1.43	0.92	0.24	0.19	0.53	0.57	1.28	1.37	13.10
Boise	3.61	3.57	3.57	3.34	3.18	2.89	3.49	3.62	3.14	3.15	3.33	3.45	40.11
Burlington	3.76	3.77	3.04	2.15	2.85	3.38	3.50	3.37	3.48	2.97	2.06	1.88	30.61
Charleston	3.02	2.95	3.02	2.78	3.00	4.59	6.89	6.53	3.27	3.27	2.14	2.72	45.22
Chicago	3.80	3.50	3.58	2.78	3.54	3.80	3.35	3.21	3.14	2.53	2.37	2.04	32.86
Calcuttas	3.06	2.67	3.50	2.87	3.59	3.31	3.57	3.26	2.46	2.46	2.77	2.73	36.34
Denver	0.40	0.53	1.04	2.06	2.21	1.38	1.68	1.43	0.99	1.05	0.55	0.73	14.05
Des Moines	2.07	1.12	1.78	2.91	4.56	4.76	3.50	3.52	3.67	2.50	1.43	1.22	32.04
Detroit	0.51	0.77	0.89	1.94	2.89	3.56	3.32	2.78	2.90	2.38	2.44	2.35	32.05
Dodge City	0.57	0.65	0.79	1.12	2.29	2.34	1.14	0.77	1.90	1.30	0.73	0.57	20.51
Hatena	0.54	0.65	0.91	2.24	2.98	3.79	3.16	2.46	1.25	0.89	0.74	0.78	20.65
Huron	2.80	2.97	2.53	3.14	4.02	3.33	6.71	5.81	7.35	4.46	1.98	3.02	49.74
Jacksonville	1.19	1.75	2.53	3.14	4.65	4.13	4.09	4.56	4.56	2.92	1.83	1.33	37.11
Laurens	0.56	0.63	1.19	2.06	2.26	1.15	0.69	0.53	0.92	1.36	0.80	0.68	12.63
Little Rock	3.10	3.84	4.62	5.19	4.78	3.76	3.50	3.75	3.17	2.71	4.19	4.14	48.38
Los Angeles	4.00	3.55	4.39	1.04	0.45	0.08	0.01	0.02	0.17	0.68	1.20	2.63	15.23
Louisville	2.52	1.83	2.17	3.09	3.72	3.82	3.70	3.42	2.78	2.65	3.61	3.74	43.26
Miami	0.86	0.86	1.42	3.67	4.22	6.86	5.42	6.17	8.34	8.44	2.91	1.69	55.66
Minneapolis	5.20	5.45	5.99	4.30	3.64	3.80	4.86	4.23	2.99	2.08	1.27	0.98	27.66
Montgomery	4.76	4.34	5.11	4.13	3.87	4.00	3.88	3.71	3.42	2.49	3.50	4.84	51.19
Nashville	4.34	4.25	4.72	5.24	4.60	5.88	6.37	5.80	5.03	3.30	3.14	4.79	57.46
New Orleans	3.66	3.82	3.64	3.23	3.24	3.33	4.24	4.33	3.39	3.53	2.96	3.62	42.99
New York	1.11	1.11	1.98	3.29	4.88	3.67	2.86	2.89	3.05	2.86	1.87	1.50	31.15
Oklahoma City	0.70	0.89	1.37	2.51	3.77	4.56	3.54	3.05	3.21	2.17	1.07	0.93	27.77
Omaha	0.80	0.77	0.68	0.40	0.12	0.07	1.07	0.95	0.75	0.47	0.70	1.00	7.78
Phoenix	3.05	2.62	3.03	2.92	3.21	3.81	4.05	3.23	2.58	2.52	2.29	3.29	36.17
Pittsburgh	3.97	4.00	3.86	3.38	3.40	3.28	3.24	3.14	3.10	3.14	3.48	3.97	41.94
Portland, Me.	6.60	5.36	3.91	2.67	2.19	1.52	0.61	0.64	1.98	3.12	6.10	6.72	41.62
Portland, Ore.	3.66	3.87	3.87	3.47	3.81	4.39	5.40	5.41	3.61	2.86	2.28	3.58	46.26
Raleigh	2.89	2.69	2.76	2.35	2.94	3.00	2.96	2.88	2.45	2.65	2.54	2.72	32.83
Rochester	2.34	2.56	3.38	3.61	4.34	3.82	2.98	2.99	3.46	2.72	2.83	2.21	37.44
St. Louis	1.31	1.51	1.98	2.05	1.92	0.80	0.51	0.85	0.98	1.44	1.35	1.43	16.13
Salt Lake City	2.06	2.03	1.72	0.77	0.35	0.05	0.03	0.04	0.08	0.54	0.76	1.87	10.30
San Diego	4.54	3.85	3.14	1.61	0.80	0.18	0.22	0.01	0.45	1.12	2.35	3.95	22.02
San Francisco	0.67	0.75	0.80	1.00	1.26	1.08	0.32	0.28	1.45	1.18	0.68	0.74	14.27
Santa Fe	1.95	1.84	1.84	2.30	3.03	2.92	2.89	2.62	4.19	3.74	5.07	5.60	32.33
Saulte Ste. Marie	4.94	3.89	3.05	2.38	1.87	1.33	0.63	0.70	1.77	2.84	5.03	5.60	34.03
Seattle	1.94	1.84	1.84	2.30	3.03	2.92	2.89	2.62	4.19	3.74	5.07	5.60	32.33

TABLE VI (Continued)
MEAN PRECIPITATION, INCHES

Stations	Jan.	Feb.	Mar.	April	May	June	July	Aug.	Sept.	Oct.	Nov.	Dec.	Annual
Spokane.....	2.16	1.77	1.20	1.13	1.42	1.28	0.69	0.62	0.90	1.17	2.09	2.19	16.62
Washington, D. C.....	3.55	3.27	3.75	3.27	3.70	4.13	4.71	4.01	3.24	2.84	2.37	3.32	42.16
Winnemucca.....	1.03	0.91	0.96	0.84	0.88	0.72	0.21	0.20	0.41	0.62	0.68	1.08	8.54
Honolulu.....	3.74	4.26	3.76	2.28	1.88	1.10	1.31	1.46	1.53	1.92	4.21	4.15	31.60
Juneau.....	6.90	5.27	5.11	5.26	5.16	3.73	2.87	3.00	10.68	10.33	8.29	7.37	80.57
Nome.....	0.97	1.06	0.89	0.61	0.88	1.22	2.87	3.00	2.34	1.47	0.98	1.13	17.42
San Juan.....	4.15	2.76	3.15	4.36	5.24	5.30	5.94	5.98	5.91	5.86	6.77	5.50	60.92
North America (except United States and Central America)													
Calgary.....	0.5	0.6	0.7	0.7	2.4	3.2	2.6	2.6	1.2	0.6	0.7	0.5	16.4
Kamloops.....	0.9	0.8	0.3	0.4	0.9	1.2	1.3	1.0	0.9	0.6	1.0	1.5	11.0
Quebec.....	3.4	3.3	3.3	2.1	3.2	4.1	4.3	4.0	3.8	3.1	3.0	3.1	40.7
St. Johns.....	6.3	5.7	4.7	4.3	3.2	3.9	3.6	3.7	3.5	6.2	6.0	5.4	56.5
Toronto.....	2.8	2.4	2.1	2.4	2.9	2.6	3.0	2.6	2.8	2.6	2.6	2.6	31.4
Winnipeg.....	0.8	0.7	1.2	1.5	2.1	3.0	3.2	2.2	2.1	1.4	1.0	0.9	20.2
Mexico City.....	0.2	0.2	0.6	0.6	1.9	3.9	4.1	4.7	4.1	1.8	0.5	0.2	23.1
Colon.....	3.9	1.7	1.7	4.2	12.6	13.5	16.2	14.9	12.5	14.8	21.5	11.9	129.4
Havana.....	2.7	2.3	1.8	2.8	4.5	7.2	5.0	6.0	6.7	7.4	3.1	2.2	51.7
Guatemala.....	0.3	0.2	0.5	1.3	5.6	11.5	8.0	8.0	9.2	6.7	0.9	0.2	52.4
South America													
Buenos Aires.....	3.0	2.5	4.6	3.0	2.8	2.7	2.2	2.4	3.0	3.6	2.8	3.9	36.5
Lima.....	0.03	0.0	0.0	0.03	0.03	0.2	0.3	0.5	0.5	0.1	0.03	0.03	1.8
Para.....	10.3	12.6	13.3	18.2	9.3	5.7	4.9	4.3	3.2	2.5	2.3	5.1	96.7
Quito.....	3.2	3.9	4.8	7.0	4.6	1.5	1.1	2.2	2.6	3.9	4.0	3.6	42.3
Rio de Janeiro.....	5.0	4.3	5.3	4.4	3.5	2.0	1.6	1.8	2.6	3.2	4.3	5.4	43.4
Santiago.....	0	0.1	0.2	0.6	2.3	3.2	3.4	2.4	1.2	0.6	0.2	0.2	14.4
Europe													
Athens.....	2.0	1.5	1.3	0.8	0.7	0.6	0.3	0.4	0.6	1.7	3.0	2.4	15.4
Belgrade.....	1.2	1.3	1.6	2.3	2.8	3.2	2.7	1.9	1.7	2.2	1.7	1.7	24.4
Berlin.....	1.5	1.3	1.7	1.4	2.0	2.0	3.1	2.2	1.8	1.8	1.6	1.7	22.2
Constantinople.....	3.4	2.7	2.4	1.7	1.2	1.3	1.1	1.7	2.0	2.5	4.0	4.8	28.9
Copenhagen.....	1.3	1.3	1.5	1.3	1.5	1.8	2.3	2.6	1.8	2.1	1.7	1.8	20.7

Dublin	2 2	1 9	1 9	1 9	1 9	2 0	2 0	2 6	3 0	1 9	2 7	2 7	2 1	2 5	2 7
Edinburgh	2 7	1 9	1 9	1 9	1 4	2 0	1 9	2 7	3 1	2 0	2 6	2 1	2 1	2 2	2 5
Geneva	1 6	1 8	1 8	1 8	1 5	2 2	3 0	3 1	3 5	3 1	4 4	3 4	3 4	2 2	2 5
London	1 9	1 7	1 7	1 7	1 6	1 8	2 0	2 4	2 2	2 2	2 6	2 6	3 1	2 2	2 5
Madrid	1 3	1 4	1 4	1 7	1 9	1 7	1 2	0 5	0 4	1 3	1 8	1 9	1 9	1 6	1 6
Marseilles	1 9	1 4	1 4	1 2	1 7	1 9	1 0	0 6	0 9	2 5	4 0	3 1	3 1	2 0	2 2
Moscow	1 1	0 9	0 9	1 1	1 5	1 1	2 3	2 8	2 9	2 2	1 4	1 6	1 6	1 5	1 5
Odessa	0 9	1 2	1 2	1 1	1 1	1 3	3 3	2 2	1 2	1 4	1 1	1 8	1 8	1 3	1 6
Paris	1 5	0 7	0 7	1 1	1 7	1 7	2 3	2 2	2 2	2 0	2 3	2 3	1 4	1 7	1 8
Petrograd	0 9	1 8	1 8	1 6	0 9	1 7	1 8	2 7	2 7	2 0	1 7	1 7	1 4	1 2	1 8
Rome	1 1	0 8	0 8	0 9	2 7	2 8	1 6	0 7	1 1	2 8	4 6	4 6	4 6	3 5	3 2
Vienna	3 1	2 5	2 5	2 7	2 0	2 8	2 8	2 8	2 1	2 0	1 7	1 7	1 4	1 7	1 8
Warsaw	1 5	1 3	1 3	1 8	2 7	2 8	2 8	2 7	2 8	2 8	1 9	1 9	1 6	3 5	2 4
Yokohama	3 1	2 5	2 5	2 7	2 0	2 8	2 8	2 8	2 1	2 0	1 7	1 7	1 4	1 7	1 8
Asia															
Bagdad	1 1	1 1	1 1	1 2	0 8	0 2	0	0	0	0	0 1	0 1	0 8	1 2	8 6
Batavia	13 0	13 6	13 6	1 8	4 8	3 7	3 6	2 7	1 3	2 6	4 1	4 1	5 0	8 7	70 9
Bombay	0 1	0	0	0 1	0	0 7	20 6	27 3	16 0	11 8	2 4	2 4	0 4	0	79 4
Delhi	1 0	0 6	0 6	0 5	4	1 7	2 9	7 6	7 0	4 7	0 5	0 5	0 1	0 4	26 2
Hong Kong	1 4	1 1	1 1	2 6	5 5	10 2	15 1	11 4	14 0	11 5	4 5	4 5	1 6	1 3	80 1
Manila	0 8	0 5	0 5	0 8	1 2	5 2	10 2	17 4	17 0	13 8	6 7	6 7	5 7	2 8	82 0
Peking	0 1	0 2	0 2	0 2	1 6	1 4	8 7	9 8	8 5	2 6	0 6	0 6	0 3	0 1	24 9
Singapore	8 5	6 1	6 1	6 5	6 9	1 2	3 0	8 8	8 5	2 6	8 2	8 2	10 0	10 4	92 9
Tokio	2 0	2 6	2 6	4 3	5 3	5 9	6 3	5 6	4 6	7 5	7 2	7 2	4 3	2 3	57 9
Tomsk	1 1	0 8	0 8	0 8	0 7	1 5	2 7	3 0	2 3	1 4	2 4	2 4	1 4	1 9	19 9
Verkhovansk	0 2	0 1	0 1	0	0 1	0 3	0 5	1 2	0 9	0 2	0 2	0 2	0 2	0 2	3 9
Vladivostok	0 1	0 2	0 2	0 3	1 2	1 3	1 5	2 2	3 5	2 4	1 6	1 6	0 5	0 2	14 7
Africa															
Addis Ababa	0 6	1 9	1 9	2 8	3 4	3 0	5 7	11 0	12 1	7 6	0 8	0 8	0 6	0 2	49 6
Algiers	4 2	3 5	3 5	3 5	2 3	1 3	0 6	0 1	0 3	1 1	3 1	3 1	4 6	5 4	30 0
Pretoria	0 6	0 5	0 5	1 1	5 4	14 8	21 3	36 8	39 6	32 5	15 2	15 2	5 3	1 3	174 4
Pretoria	5 5	3 9	3 9	3 5	4 1	0 6	0	0 1	0 2	1 1	0 1	0 1	3 7	4 2	25 9
Port Said	0 9	0 4	0 4	0 4	0 2	0 1	0	0	0	0	0 1	0 1	0 5	0 7	3 3
Australia and New Zealand															
Auckland	2 9	3 0	3 0	3 1	3 3	4 4	4 8	5 0	4 2	3 6	3 6	3 6	3 3	2 9	43 8
Darwin	15 3	13 0	13 0	9 7	4 5	7 7	0 2	0 1	0 1	0 5	2 1	2 1	5 2	10 3	61 7
Melbourne	1 9	1 8	1 8	2 2	2 3	2 2	2 1	1 9	1 8	2 4	2 7	2 7	2 2	2 3	25 6
Perth	0 3	0 3	0 3	0 7	1 7	4 9	6 6	6 4	5 6	3 3	2 1	2 1	0 8	0 6	33 3

APPENDIX IV

Climatological Section Centers of the U. S. Weather Bureau

<i>State</i>	<i>Section Center</i>
Alabama	Montgomery
Arizona	Phoenix
Arkansas	Little Rock
California	San Francisco
Colorado	Denver
Connecticut (see New England)	
Delaware (see Maryland)	
District of Columbia (see Maryland)	
Florida	Jacksonville
Georgia	Atlanta
Idaho	Boise
Illinois	Springfield
Indiana	Indianapolis
Iowa	Des Moines
Kansas	Topeka
Kentucky	Louisville
Louisiana	New Orleans
Maine (see New England)	
Maryland	Baltimore
Massachusetts (see New England)	
Michigan	Lansing
Minnesota	Minneapolis
Mississippi	Vicksburg
Missouri	St. Louis
Montana	Helena
Nebraska	Lincoln
Nevada	Reno
New England	Boston
New Hampshire (see New England)	
New Jersey	Trenton
New Mexico	Albuquerque
New York	Ithaca
North Carolina	Raleigh
North Dakota	Bismarck

Ohio	Columbus
Oklahoma	Oklahoma City
Oregon	Portland
Pennsylvania	Harrisburg
Rhode Island (see New England)	
South Carolina	Columbia
South Dakota	Huron
Tennessee	Nashville
Texas	Houston
Utah	Salt Lake City
Vermont (see New England)	
Virginia	Richmond
Washington	Seattle
West Virginia	Parkersburg
Wisconsin	Milwaukee
Wyoming	Cheyenne

Index

A

- Abbe, C., 351
Abbot, C. G., 90
Absolute humidity, 46
Absolute temperature scale, 17
Absolute zero, 9
Absorption:
 and angle of incidence, 94
 of radiant energy, 88
 selective, 88
Accumulated sums of departures, 305
Aden, Arabia, 296
Adiabatic temperature changes, 103-105
Aerological service of Weather Bureau, 361
Aeronautical meteorology, 333-337
Agricultural:
 meteorology, 328-333
 service of Weather Bureau, 359
Air (*see also* Atmosphere):
 conditioning, 324
 cooling power of, 323
 effect of insolation on, 95
 electrical conductivity, 339
 latitudinal interchange of, 170-173
 mixing processes, 170
 movement across equator, 172
 movement and health, 322
 movement, polar-equatorial, 155
 orographic uplift, 137
 temperature, 22, 99
 upper, 77-80, 169
 volume and pressure, 8
 volume and temperature, 8
Air-mass analysis, 236
 bibliography, 371
Air masses, 196-198, 236-240
Airplane observations, 79
Airports, 335
Airway:
 forecasts, 334
 observations, 333
 operation, 335
 service, of Weather Bureau, 361
 substations, 354
Albright, J. G., 370
Aleutian low, 167
Alexander, W. H., 216, 372
Almanac "forecasts," 251
Altimeter, 32
Altitude:
 barometric determination of, 31
 relation of wind velocity to, 39
 variation of pressure with, 29
Alto cumulus, 66
 illustrated, 60, 61
Altostratus, 66
 illustrated, 62
Analysis, air-mass, 236
Anderson, O. A., 78
Anemometer:
 deflection, 35
 exposure of, 39
 pressure tube, 35
 Robinson cup, 35
 illustrated, 37
Anemoscope, 34
 record, illustrated, 38
Aneroid barometer, 28
Angle of incidence, 91, 94
Animals and the weather, 251
Annual march of temperature, 24
Annual range of temperature, 25
Anomalies, temperature, 285
Anticyclones, 186-188
 origin, 194
 tracks and velocities, 186
 types of, 195
 typical paths in United States,
 chart, 188
Anticyclonic circulation, 186
Antitrades, 170
Appleton layer, 120
Arctic air masses, 236
Arequipa, Peru, 296
Argon, 4
Aristotle, 3
Articles, meteorological, bibliogra-
 phy, 372
Aspiration psychrometer, 53
Assman, R. A., 115
Astronomical twilight, 347
Astronomy and meteorology, 3
Atlas:
 of American Agriculture, 374
 of Meteorology, 374

- Atmosphere (*see also* Air):
 composition, 4-7
 content, as climatic control, 315
 density, 10
 dust in, 6
 height of, 10
 layers in, 115-121
 organic matter in, 6
 permanent gases of, 4
 pressure of, 9
 properties of, 7-10
 refraction in, 343
 responses of, 272
 standard, 27
 water vapor of, 5
 Audibility, zones of, 118
 Auroras, 340
 illustrated, 341

B

- Baguio, 198
 Baguio, Philippines, 295
 Ball lightning, 219
 illustrated, 220
 Ballons-sondes, 78
 Balloons, 78
 Bar, 27
 Barograph, 29
 record, illustrated, 30
 Barometer:
 aneroid, 28
 corrections, 27
 Fortin, 26
 invention of, 11
 mercury, 25
 scales, 27
 units, 26
 Barometric:
 depressions, 182-186
 tendency, 29, 234
 Batavia, Java, 117
 Beaufort wind scale, 35, 36
 Belts:
 pressure, 162-164
 temperature, 299
 Bentley, W. A., 139, 371
 Besson, L., 259
 Bibliography, 370-375
 Bigelow, F. H., 189
 Bjerknes, J., 236, 371
 Bjerknes, V., 190
 Blair, T. A., 140, 372
 Blizzard, 228
 Boll weevil and the weather, 332
 Bora, 154
 Bowie, E. H., 373
 Boyle's law, 8, 103
 Breeze, 36
 lake, 152
 land, 152

- Breeze (*Cont.*):
 mountain, 153
 sea, 151
 valley, 152
 Brooks, C. E. P., 374
 Brooks, C. F., 370, 373, 374
 Bruckner cycle, 303
 Bruckner, E., 303
 Brunt, D., 189, 370, 371
 Bulletins, meteorological, bibliogra-
 phy, 372
 Bumpiness, 336
 Buys-Ballot's law, 150, 183
 Byers, H. R., 170

C

- California rainfall, 268
 Campbell-Stokes sunshine recorder,
 75
 Campos, 296
 Canyon winds, 154
 Carbon dioxide, 5
 Castellated altocumulus, 66
 Ceiling, 76
 balloons, 78
 lights, 77
 Celsius, A., 17
 Centigrade scale, 16
 tables, 379
 Central office, Weather Bureau,
 352
 Centrifugal force, 148
 Charles' law, 8
 Charts:
 climatic, bibliography, 375
 dot, 331
 frost, bibliography, 375
 synoptic, 176
 Cheney, Nebr., 229
 Cherra Punji, India, 295
 Chicago, Ill., 152, 256, 355
 Chinook, 226
 Circulars of Weather Bureau, 375
 Circulation:
 anticyclonic, 186
 convectonal, 102
 cyclonic, 183
 general, 160
 secondary, 176
 upper air, 169
 Cirrocumulus, 58
 illustrated, 59
 Cirrostratus, 66
 illustrated, 60
 Cirrus, 58
 illustrated, 59
 nothus, 58
 Civilization:
 and climate, 327

- Civilization (*Cont.*):
 climatic hypothesis of, 326
 temperature of, 327
- Civil Service Commission, 353
- Civil twilight, 347
- Clark, G. A., 372
- Clayden, A. W., 372
- Clayton, H. H., 372, 374
- Clear day, 68
- Cleveland, Ohio, 257
- Climate:
 and atmospheric content, 315
 and civilization, 326, 327
 and crops, 329
 and culture, 325-328
 and distribution of land, 315
 and physical features of land,
 299-302
 and position of earth, 314
 coastal or littoral, 300
 continental, 300
 cyclical changes of, 302-314
 defined, 12
 influence of extreme, 326
 marine, 300
 mediterranean, 298
 mountain and plateau, 301
 physical, 279
 secular trends of, 311
 solar, 278
 stability of, 316
 steppe, 298
- Climatic:
 charts, bibliography, 375
 controls, 314-316
 data, 277, 374, 380-385
 elements, 277-279
 fluctuations, 313
 hypothesis, 326
 major influences, 302
 zones, 296-299
- Climatological:
 data, 277, 359, 364, 374, 375, 380-
 385
 section centers, 386, 387
 service of Weather Bureau, 358
 substations of Weather Bureau,
 354
- Climatology, 277
 bibliography, 374
- Cline, I. M., 199, 372
- Cloudbursts, 135
- Cloud observations, 57-69
- Clouds:
 and precipitation, 134-142
 classification of, 58
 computing heights of, 136
 formation of, 134-137
 forms of, international, 58
 heights of, 67
 high, 68
- Clouds (*Cont.*):
 low, 68
 middle, 68
 squall, 211
 velo, 132
- Cloudy day, 68
- Coastal climate, 300
- Coefficients, correlation, 263-265
- Cold air masses, 237
- Cold caps, 299
- Cold front, 190, 235, 241
- Cold wave, 227
- Colored precipitation, 229
- Colors of twilight, 6, 347
- Condensation, 45
 above surface, 130-134
 latent heat of, 46, 173
 nuclei of, 130
 on solid surfaces, 126-130
- Conditional instability, 113
- Conditioning of air, 324
- Conduction of heat, 99
- Conductivity, electrical, of air, 339
- Conner, A. J., 374
- Conservative properties of air, 242
- Continental air masses, 236
- Continental climate, 300
- Continental highs of winter, 168
- Controlling the weather, 251
- Controls, climatic, 314-316
- Convection, thermal, 101
 in air, 103
 in liquid, 102
 penetrative, 135
 theory of cyclonic origin, 188
- Convective circulation, 102
- Convective instability, 114
- Convergence, 137, 235
- Conversion factors and tables, 376-
 379
- Cooling, degree days of, 325
- Cooling power of air, 323
- Coöperative:
 activities of Weather Bureau,
 365
 observers of Weather Bureau,
 358
 substations of Weather Bureau,
 354, 358
- Copenhagen, Denmark, 311
- Coriolis force, 148
- Corona, 347
- Correlation coefficients, 263, 264
 multiple, 264
- Correlations:
 weather, 262-265
 weather and crops, 331
- Counter-current theory, 189
- Covert, R. N., 373
- Critical periods of plants, 330
- Croll's theory, 315

- Crops:
 and climate, 329
 and weather, 330
- Crop substations of Weather Bureau, 354
- Culture and climate, 325-328
- Cumulonimbus, 67
 illustrated, 65
- Cumulus, 67
 computing height of, 136
 illustrated, 64
- Currents, ocean, 269, 282, 291
- Curves:
 accumulated sums of departure, 305
 frequency, 257
 moving sums, 311
- Cycles:
 Bruckner, 303
 rainfall, 309
 sunspot, 303
 weather, 303-305
- Cyclical changes of weather and climate, 302-314
- Cyclone cellar, 221
- Cyclones, extratropical:
 Bjerknes' ideal form of, 190
 convection theory of, 188
 countercurrent theory of, 189
 eddy theory of, 189
 estimating path and velocity, 234
 heat, 189
 movement of, 184
 movement of air in, 193
 nature and origin of, 188-194
 occluded, 192
 paths of, *chart*, 185
 polar-front theory of, 189
 secondary, 184, 192
 source regions of, 184
 types of, 185
 vertical section of, 192
 V-shaped, 183
- Cyclones, tropical, 198-206
 characteristics, 198
 effects of, 204
 lowest pressure in, 202
 ocean swells preceding, 206
 of September, 1900, 206
 of September, 1926, *chart*, 205
 origin and paths, 203
 over Florida Keys, Sept., 1935, 200
 regions and times of occurrence, 202
- Cyclonic circulation, 183
- D
- Daily march of temperature, 23
 Daily range of temperature, 24
- Data, climatic, 277
 bibliography, 374
- Davis, W. M., 370
- Dawson, Canada, 289
- Death rate and weather, 322
- Death Valley, Calif., 289, 296
- Deflection anemometer, 35
- Deflective influence of earth, 148, 173
- Degree days, 325
- Denver, Colo., 355
- Department of Agriculture, U. S., 352
- Depressions, barometric (*see* Cyclones, extratropical)
- Deserts, 300
- Des Moines, Iowa, 256
- Dew, 127
- Dew point, 45
 tables, 51
- Diffraction, 346
- Dines, W. H., 100, 373
- Direction, wind, 34
- Discontinuity, surface of, 190
- Display substations of Weather Bureau, 354
- Distribution:
 of land, as climatic control, 315
 of precipitation, 289-296
 of temperature, 279-289
- District forecasts, 355
- Disturbances, barometric (*see* Cyclones, extratropical)
- Disturbances, lesser, 210
- Diurnal variation:
 of pressure, 33
 of wind velocity, 41
- D* layer of atmosphere, 120
- Doldrums, 162, 164
- Dot chart, 331
- Douglas, C. K. M., 371
- Douglass, A. E., 312
- Downs, 296
- Drizzle, 130
- Droughts, 306-310, 332
- Dry adiabatic rate, 104
- Duane, J. E., 200
- Dubuque, Iowa, 249, 250
- Duration of sunshine, 94
- Dust:
 atmospheric, 6
 falls, 229
 meteoric, 6
 storms, 228
 illustrated, 229
 volcanic, 6, 315
 whirls, 226
- Dynamic changes of temperature, 103-105
- Dyne, 27

E

- Earth:
 distance from sun, 91
 electrical field, 339
 rotational effect on winds, 147,
 173
 temperatures, 101
 Easterlies, polar, 169
 Eddy motion in cloud formation,
 137
 Eddy theory of cyclonic origin, 189
 Edmonton, Canada, 301
 Effective temperature, 323
E layer of atmosphere, 120
 Electrical:
 charge in thunderstorms, 217
 field of earth, 339
 phenomena of air, 339-341
 sunshine recorder, 73
 Electromagnetic vibrations, 86
 Elements:
 climatic, 277-279
 meteorological, 11
 Elevation of land as climatic con-
 trol, 315
 Eleven-year cycle, 303
 Ellendale, N. D., 109
 Energy:
 radiant, 86-89
 sources of, in air, 172, 197
 Equations, regression, 264
 Equatorial:
 air masses, 236
 belt of low pressure, 162
 zone, 296
 Equilibrium, 110
 Equinoctial storm, 251
 Equinoxes, 92
 Equivalent potential temperature,
 107, 242
 Ether waves, 86
 Evaporation, 44
 amount of, 55
 balanced by precipitation, 126
 measurement of, 56
 observations, 55-57, 364
 station, illustrated, 56
 Excessive rainfall, 72
Explorer II, 78, 118
 Exposure:
 of anemometer, 39
 of rain gage, 71
 of thermometer, 20
 of wind vane, 39
 Extratropical cyclones (*see* Cy-
 clones, extratropical)
 Extremes:
 of precipitation, 295, 296
 of temperature, 287-289

F

- Fahrenheit scale to centigrade, 378
 Fahrenheit thermometer, 16
 Fallwinds, 154
 "False cirrus," 58
 Fire-weather service, 361
 First-order weather stations, 353
 Fisk, Dorothy, 122
F layer of atmosphere, 120
 Flood service of Weather Bureau,
 362
 Floreen, H., 59-65
 Florida Keys' storm, 200
 Fluctuations of climate, 311-314
 Foehn, 226
 Fog, 130
 advective, 132
 dense, 131
 dispersal, 133
 ground, 131
 hazard in flying, 336
 high, 132
 light, 131
 London, 133
 moderate, 131
 Newfoundland, 133
 radiation, 131
 thick, 131
 Forces affecting moving air, 148
 Forecast districts, 355
*Forecasting from Synoptic Weather
 Charts*, 365
 Forecasting, long-range, 272-274
 Forecasting river stages, 362
 Forecasting weather, 233-254
 Forecasts:
 airway, 334
 district, 355
 local, 248
 Forecast service of Weather Bureau,
 355
 Forest fire-weather service, 361
 Forked lightning, 218
 Fort Hope, Canada, 301
 Fortin barometer, 26
 Fort Omaha, Nebr., 109
 Fort Stockton, Tex., 289
 Fractocumulus, 67
 Fractostratus, 66
 illustrated, 62
 Franklin, B., 79
 Frequency:
 curves, 257
 polygons, 257
 Front:
 cold, 190, 241
 estimating movement of, 244
 identifying, 242
 occluded, 192, 241

- Front (*Cont.*):
 polar, 169
 polar, theory, 189
 upper, 190, 241
 warm, 192, 235, 240
- Frost:
 "black," 128
 charts, bibliography, 375
 conditions favoring, 128
 defined, 127
 degrees of, 127
 killing, 128
 protection against, 128
- Fruit-frost service of Weather Bureau, 360
- G
- Gages, rain, 69-71
 illustrated, 70, 71
- Gale, 36
- Galileo, 11
- Galveston, Tex., 206
- Gases:
 laws of, 8
 permanent, of air, 4
- Gay-Lussac, law of, 8
- Geddes, A. E. M., 370
- General circulation, 160
- Geographic distribution:
 precipitation, 289-291
 temperature, 279-285
 thunderstorms, 214-217
 tornadoes, 224
 tropical cyclones, 202
- Geostrophic wind, 150
- Giblett, M. A., 371
- Glaciers and climatic fluctuations, 313
- Glaze, 141
 illustrated, 142
- Glazed frost, 142
- Glenora, Ore., 295
- Gold, E., 116, 371
- Government Land Office, 351
- Gradient:
 pressure, 145-147
 vertical temperature, 108
- Gradient winds, 147-150
- Grain rusts and weather, 332
- Graupel, 142
- Gravitation, 173
- Gravity corrections to barometer, 28
- Gravity winds, 154
- Great Britain Meteorological Office, 370, 372
- Greenland Ranch, Calif., 296
- Groesbeck, Tex., 109
- Growing season, 258
- Growth rings of trees, 312
- Gulf Stream and northeast trades, 267
- Gusts, 38
- H
- Hail, 140
 colored, 229
 formation of, 141
 soft, 142
- Hailstones, illustrated, 140
- Hair hygograph, 53
 hygrometer, 53
- Hales, W. B., 154
- Hallenbeck, C., 373
- Halo, 345
- Hann, J., 374
- Haurwitz, B., 371
- Hawaiian Islands, 130, 137
- Haynes, B. C., 372
- Hazards in aviation, 336
- Haze, 130, 131
 optical, 343
- Health and weather, 321-325
- Heat:
 conduction of, 99
 interchange of, in air, 100
 latent:
 of condensation, 46
 of vaporization, 44
 nature of, 15
 rays, 87
 thunderstorm, 213
- Heaters, orchard, 129
- Heating, degree days of, 325
- Heaviside-Kennelly layer, 120
- Height of atmosphere, 10-11
 of clouds, 67
- Helen Mine, Calif., 295
- Helium, 5
- Helivan, Egypt, 296
- Henry, A. J., 375
- Henry, Joseph, 351
- Hertzian waves, 87
- Highest air temperatures of record, 289
- Highs, barometric (*see* Anticyclones)
- Hoarfrost, 127
- Honolulu, Hawaii, 263, 357
- Horse latitudes, 162
- Horticultural service of Weather Bureau, 359
- Hot belt, 299
- Hot spells, 114
- Hot winds, 227, 322
- Howard, Luke, 58
- Humidity:
 absolute, 46
 and health, 322
 measurement of, 48

- Humidity (*Cont.*):
 observations, 44-55
 records, 53
 relative, 47
 table, 52
 specific, 48, 243
 Humphreys, W. J., 116, 141, 156,
 217, 315, 339, 346, 372
 Huntington, E., 328
 Hurricane, 198
 wind, 36
 Hydrogen in air, 5
 Hydrologic service, 363
 Hydrometeors, 130
 Hygrograph, 53
 record, illustrated, 54
 Hygrometer:
 dew point, 49
 hair, 53
 Hygroscopic particles, 130
 Hypothesis, climatic, 326
- I
- Iceland low, 167
 Ice storm, illustrated, 142
 Ideal weather, 324
 Inches into millibars, 377
 Incidence, angle of, 91
 Indianapolis, Ind., 258
 Indian monsoon, 171
 Inferior mirage, 344
 Influences, major climatic, 302
 Insolation, 89, 90, 173
 amount received, 91-95
 as climatic control, 314
 direct effects of, 95-97
 Instability, 111
 conditional, 113
 convective, 114
 in thunderstorms, 213
 latent, 114
 Instrument shelter, 22
 Interchange, latitudinal, of air, 170
 Intermediate zones, 297
 International:
 cloud classification, 58
 Cloud Commission, 367
 exchange of observations, 367
 Meteorological Organization, 367,
 373
 polar year, 367
 Inversion of temperature, 109
 Ionized layers, 119
 Ionosphere, 121
 Ions, 120
 Isentropic analysis, 357
 Isobaric surfaces, 146
 Isobars, 145
 annual, *chart.* 161
 January, *chart.* 165
 July, *chart.* 166
 Isohyets, 289
 Isothermal region, 116
 Isotherms, 178; *charts.* 280-284
- J
- Jacksonville, Fla., 355
 Jensen, J. C., 219, 220
 Johnson, Kans., 229
 Juneau, Alaska, 357
- K
- Katabatic winds, 154
 Katmai, 315
 Kendrew, W. G., 374
 Key West, Fla., 24
 Kimball, H. H., 373
 Kincer, J. B., 215, 311, 312, 373
 Kinematical forecasting, 248
 Kipling, R., 219
 Kite:
 observations, 79
 flights, 109
 Krakatoa, 6, 315
 Krypton, 5
- L
- Lagos, Nigeria, 264
 Lake breeze, 152
 Land:
 breeze, 152
 distribution and climate, 315
 heating of, 96, 282
 Office, 351
 Landor, W. S., 325
 Landsberg, H., 374
 Lapham, I. A., 351
 Lapse rates, 107-114
 La Serena, Chile, 296
 Latent heat:
 of condensation, 46, 173
 of vaporization, 44
 Latent instability, 114
 Latitudinal interchange of air, 170-
 173
 Layers, atmospheric, 115-121
 Lenticular altocumulus, 61
 Lesser disturbances of the air, 210
 "Lids," 76
 Lightning, 218-220
 Lightning rods, 220
 Light, velocity of, 88
 Lincoln, Nebr., 21, 30, 54, 230, 256
 260
 Line squalls, 214
 Littoral climate, 300

Llanos, 296
 Local forecasts, 248
 London fogs, 133
 Long-range forecasting, 272
 Lore, weather, 248
 Low, barometric (*see* Cyclone, ex-
 tratropical)
 Lowest air temperatures, 287, 289
 Lunar halo, 345

M

Mackerel sky, 66
 McDonald, W. F., 201, 202
 McEwen, G. F., 268, 373
 Madison, Wis., 229
 Manoyuram, India, 295
 Maps:
 climatic bibliography, 374
 weather, 176-182
 illustrated, 179-181, 245-247
 March of temperature:
 annual, 24
 daily, 23
 Marine climate, 300
 Marine meteorological service, 360
 Maritime air masses, 236
 Marquette, Mich., 293
 Marvin, C. F., 266, 373
 Masses, air, 196-198, 236-240
 Maximum thermometer, 18
 Median, 257
 Mediterranean climate, 298
 Meteorograph, 34, 40, 70, 73
 Meteorological elements, 11
 Meteorology:
 advanced treatises on, 371
 aeronautical, 333-337
 agricultural, 328-333
 defined, 2
 elementary treatises on, 370
 relation to other sciences, 2
 Meteors, 6
 Middleton, W. E. K., 372
 Midway Island, 264
 Migration of isotherms, 282
 Milham, W. I., 370
 Millibar, 27
 Millibars into inches, 377
 Milwaukee, Wis., 152
 Minimum thermometer, 18
 Mirage, 344
 Mistral, 154
 Mitchell, C. L., 373
 Mixing ratio, 243
 Mock sun, 346
 Mode, 257
 Modified air masses, 240
 Monsoons, 155
 Indian, 171

Montgomery, R. B., 373
Monthly Weather Review, 365
 Moon and the weather, 251
 Moose Factory, Canada, 301
 Mountain:
 breeze, 153
 observations, 77
 Mountain and plateau climate, 301
 Mt. McKinley, 10, 287
 Mt. Waialeale, 295, 297
 Mt. Washington, 77
 Moving sums, 311
 Myer, A. J., 351

N

Namias, J., 371
 Neon, 5
 New Haven, Conn., 311
 New Orleans, La., 355
 New Smyrna, Fla., 295
 New York, N. Y., 40, 355
 Nimbostratus, 66
 Nimbus, 67
 Nitrogen in air, 4, 5
 Normals:
 defined, 12
 precipitation, 290, 383-385
 pressure, 161, 165, 166
 temperature, 281, 283, 284, 380-
 382
 Northern lights, 340
 Nuclei of condensation, 130

O

Observations:
 airplane, 80
 airway, 333
 balloon, 77
 ceiling, 76, 77
 cloud, 57-69
 evaporation, 55-57, 364
 exchange between nations, 367
 humidity, 44-55
 kite, 79
 mountain, 77
 phenological, 332
 precipitation, 69-73
 pressure, 25-33
 standard, 80
 sunshine, 73-75
 temperature, 15-25
 time of, Weather Bureau, 82
 upper air, 77-80
 visibility, 75, 76
 weather, beginnings of in U. S.
 350
 wind, 33-40
 Occluded front 192, 241

Occlusion, 192
 Ocean:
 currents, 269, 282, 291
 temperatures and rainfall, 268, 269
 Oceans and the weather, 266-270
 Oklahoma City, Okla., 293
 Operation, airway, 335
 Optical phenomena, 342-348
 Orchard heaters, 129
 Organic matter in air, 6
 Organization of Weather Bureau,
 352-354
 Orographic uplift of air, 137
 Oxygen in air, 4, 5
 Ozone, 5
 Ozone layer, 118
 Ozonosphere, 121

P

Pamphlets, bibliography, 372
 Paraseleue, 346
 Parhelion, 346
 Paris, France, 259
 Partial potential temperature, 243
 Partly cloudy day, 68
 Patent Office, 351
 Penetrative convection, 135
 Pensacola, Fla., 205, 293
 Periods (*see also* Cycles):
 rest, of plants, 330
 critical, of plants, 330
 Persistence of weather, 259-262
 Peru current, 269
 Peruvian rainfall, 269
 Petterssen, S., 244, 370, 371
 Phenology, 332
 Phenomena, electrical, 339-341
 optical, 342-348
 Physical climate, 279
 Piccard, A., 77
 Pick, W. H., 370
 Pike's Peak, 77
 Pilot balloons, 78
 Plateau and mountain climate, 301
 Polar:
 air masses, 236
 caps of high pressure, 163
 circle lows, 163
 easterlies, 169
 equatorial movements, 155, 156
 front, 169, 189
 ice, 268
 year, international, 367
 zones, 298
 Polygon, frequency, 257, 258
 Poplar River, Mont., 287
 Potential temperature, 106
 Potter, Nebr., 140

Precipitation:

 areas of heavy and light, 293
 balance with evaporation, 126
 California, 268
 causes of, 134-138
 cycles, 309
 excessive, 72
 extremes, 295
 forms of, 138-142
 general distribution, 289-295
 Iowa, 305
 mean annual, *chart*, 290
 measurement, 69-72
 mountain systems and, 291
 observations, 69-73
 ocean currents and, 291
 Peruvian, 269
 rainy days, 292, 294
 seasonal variations, 291
 spring wheat and, 331
 tables, 383-385
 types of distribution, 292
 Pressure, atmospheric, 9
 diurnal variations, 33
 equatorial belt of low, 162
 gradient, 145-147
 January mean, 164; *chart*, 165
 July mean, 164; *chart*, 166
 lowest observed, 202
 mean annual, *chart*, 161
 observations, 25-33
 polar caps of high, 163
 polar circle lows, 163
 reduction to sea level, 31
 station, 28
 subtropical belts of high, 162
 units, 26
 variability, 145
 variation with height, 29
 yearly averages, 160-164
 Pressure tube anemometer, 35
 Pressure, vapor, 44
 wind, 34
 Prevailing westerlies, 168
 Prince Albert, Canada, 301
 Prince Rupert, Canada, 301
 Probability of rain, 259
 Proverbs, weather, 250
 Psychrometers, 49, 50, 53
 Psychrometric tables, 51-53, 375
 Publications of Weather Bureau,
 364, 375
 Puerto Bello, Panama, 296
 Pyrheliometer, 90

R

Radiant energy, 86-89
 Radiation, 86

- Radiation (*Cont.*):
 solar, amount received, 91-95
 measurement, 90, 364
 turbulence and, 271
 Radio-meteorograph, 80
 Radiosondes, 80
 Radon, 5
 Rain, 134
 muddy, 229
 probability of, 259
 temperature of, 212
 weight of, 135
 Rainbow, 344
 Rain drops, size of, 138
 Rainfall (*see* Precipitation)
 Rain gages, 69-71
 Rainy days, annual number, 292,
 293; *chart*, 294
 Range of temperature:
 annual, 285, 286
 daily, 287, 288
 Rates, adiabatic, 104
 lapse, 107
 Recorders, sunshine, 73-75
 Reduction to sea level:
 pressure, 31
 temperature, 280
 Reflection, 89
 Refraction, 342, 343
 Register, triple, 34
 Regression equations, 263
 Regular observations of Weather
 Bureau, 81
 Relative humidity, 47
 table, 52
 Rest periods of plants, 330
 Retardation of temperature ex-
 tremes, 23, 24
 Retarded adiabatic rate, 104
 Rime, 127
 River and flood service of Weather
 Bureau, 362
 Riverside Ranger Station, Yellow-
 stone Park, 287
 River substations of Weather Bu-
 reau, 354
 Robinson cup anemometer, 35, 37
 Roses, wind, 40
 Rossby, C. G., 371
 Rotation of earth, effects, 147, 173
- S
- St. Elmo's fire, 340
 St. Johns, Canada, 301
 St. Louis, Mo., 24
 St. Paul, Minn., 261
 St. Vincent, Minn., 287
 Salt Lake City, Utah, 24
 San Francisco, Calif., 300, 355
 San Juan, Puerto Rico, 357
 Santa Fe, N. M., 215
 Saturated adiabatic rate, 104
 Saturated vapor, 44
 Saturation, 44
 Savannas, 296
 Scattering of light, 347
 Sea breeze, 151
 Sea level, reduction to:
 pressure, 31
 temperature, 280
 Seasonal forecasting, 272-274
 Seasonal variation of precipitation,
 291
 Seattle, Wash., 293
 Secondary circulation, 176
 low, 184
 Second-order weather stations, 354
 Section centers, Weather Bureau,
 359, 386, 387
 Secular trends, 311
 Selective absorption and transmis-
 sion, 88
 Shakespeare, W., 1
 Shaw, Sir Napier, 17, 115, 172, 173,
 198, 370, 371, 372
 Sheet lightning, 219
 Shelter, instrument, 22
 Signal Service, 351, 365
 Simoons, 322
 Simpson, G. C., 134, 373
 Sirocco, 227
 Sky colors, 347
 Sleet, 141
 Sling psychrometer, 50
 Smith, J. W., 266, 330, 372
 Smithsonian Institution, 351
Smithsonian Meteorological Tables,
 32, 49, 50
 Snow, 139
 crystals, illustrated, 139
 density, 71
 discolored, 229
 effect on temperature, 97
 measurement, 71
 pellets, 141
 Snowfall substations, Weather Bu-
 reau, 354
 Snowflakes, illustrated, 139
 Solar:
 climate, 278
 constant, 89, 91, 271
 halo, 345
 radiation, 90, 271, 364
 Solstices, 92
 Sounding balloons, 78, 109
 Southwest Point, Canada, 301
 Specific humidity, 48, 243
 Spectrum, radiant energy, 87
 Spells of weather, 259

Spring wheat and rainfall, 331
 Squall:
 cloud, 211
 line, 191
 wind, 212
 Squalls, line, 214
 Stability, atmospheric, 110
 climatic, 316
 Standard atmosphere, 27
 Station pressure, 28
 Stations of Weather Bureau, 353
 Statistical forecasting, 249
 Steppes, 298
 Stevens, A. W., 78
 Storms, dust, 228
 Storm wind, 36
 Stratocumulus, 66
 illustrated, 63
 Stratosphere, 115
 balloons, 78
 lower, temperatures in, 116
 upper, temperatures in, 117
 Stratus, 66
 illustrated, 63
 Streak lightning, 218
 Structure:
 of air masses, 236
 of winds, 37
 Subsidence, 114
 Substations of Weather Bureau, 352
 Subtropical:
 high pressure belts, 162
 zones, 297
 Sudan, 296
 Sun:
 and weather, 270-272
 distance from earth, 91
 Sun dog, 346
 Sunrise and sunset colors, 347
 Sunshine:
 and health, 323
 duration of, 94
 observations, 73-75
 recorders, 73
 Sunspot cycle, 303
 Sunspots and temperature, 270
 Supan's temperature belts, 299
 Superior air masses, 236
 Superior mirage, 344
 Surfaces:
 isobaric, 146
 of discontinuity, 190
 Surface winds, 147, 150
 Sutcliffe, R. C., 372
 Synoptic charts, 176

T

Tables:
 conversion, 376-379

Tables (*Cont.*):
 dew point, 51
 mean precipitation, 383-385
 mean temperature, 380-382
 psychrometric, 53
 relative humidity, 52
Smithsonian Meteorological, 32, 49
 vapor pressure, 51
 Talman, C. F., 371
 Tampa, Fla., 24, 215
 Tanana, Alaska, 289
 Tannehill, I. R., 372
 Taylor, G. F., 371
 Teisserenc de Bort, L., 115
 Temperate belts, 299
 zones (*see* Intermediate zones)
 Temperature:
 adiabatic changes of, 103
 and health, 321
 and sunspots, 270
 annual march, 24
 annual mean, 280-282; *chart*, 281
 annual range, 25, 285; *chart*, 286
 anomalies, 285
 correction of barometer, 27
 daily march, 23
 daily range, 24, 285
 distribution of, 279-289
 effective, 323
 equivalent potential, 107, 242
 extremes, 287, 289
 gradient, vertical, 108
 highest, 289
 in lower atmosphere, 114
 in lower stratosphere, 116
 in sunshine, 100
 in upper stratosphere, 117
 inversion, 109
 January mean, 282-285; *chart*, 283
 July mean, 282-285; *chart*, 284
 lowest, 287, 289
 nature of, 15
 observations, 15-25
 ocean, and weather, 266-270
 of air, obtaining, 20, 99
 of civilization, 327
 of earth, 101
 of rain, 212
 partial potential, 243
 potential, 106
 reduction to sea level, 280
 retardation, 24
 secular trends, 311
 tables, 380-382
 wet-bulb potential, 243
 zones, 299
 Tercentesimal scale, 17

- Thermal convection, 101
 Thermograph, 19
 illustrated, 20
 record, *chart*, 21
 Thermometer:
 black-bulb, 100
 centigrade, 16
 construction of, 17
 defined, 16
 Fahrenheit, 16
 invention of, 16
 maximum, 18
 minimum, 18
 scales, 16, 17
 Thick dust, 334
 Third-order weather stations, 354
 Thunder, 218
 Thunderstorm nose, 212
 Thunderstorms, 210-220
 annual number in U. S.; *chart*, 216
 conditions requisite, 212
 electric charge, 217
 geographic distribution, 214
 hazards in flying, 336
 heat, 213
 local, 210
 time of occurrence, 215
 violent movements in, 211
 Tonitro cirrus, 58
 Topil, A. G., 372
 Tornadoes, 220-226
 illustrated, 222, 223
 Torricelli, E., 11, 25
 Townsend support, illustrated, 19
 Trade winds, 167
 and Gulf Stream, 267
 depth of, 170
 Transfer of heat:
 conduction, 99
 convection, 101
 radiation, 86
 Tree rings, 312
 Trends, secular, 311
 Trewartha, G. T., 371
 Trigger action, 251
 Triple register, 34
 Tripoli, 289
 Tropical air masses, 236
 Tropical cyclones (*see* Cyclones, tropical)
 Tropopause, 116
 Troposphere, 115
 upper, 170
 Trough of low pressure, 183
 Turbulence, 38, 271
 relation to lapse rate, 113
 Twilight, 6, 347
 Twinkling of stars, 343
 "Twister," 220
- Types:
 of anticyclones, 195
 of cyclones, 185
 of rainfall distribution, 292
 weather, 260
 Typhoon, 198
- U
- United States:
 Army, 366
 Engineer Corps, 366
 Forest Service, 362, 366
 Geological Survey, 366
 Navy, 366
 Weather Bureau (*see* Weather Bureau)
 Unstable air, 111
 Upper air:
 circulation, 169
 observations, 77-80
 Upper front, 192, 241
 Upper troposphere, 170
- V
- Valley breeze, 152
 Vane, wind, 34
 exposure of, 39
 Vaporization, latent heat of, 44
 Vapor pressure, 44
 saturation, tables, 51
 Variability:
 of pressure, 145
 of weather, 255-259
 of wind, 37-41
 Velocity:
 of light, 88
 wind, 34
 Velo cloud, 132
 Verkhoyansk, Siberia, 287
 Vertical temperature gradient, 108
 Vibrations, electromagnetic, 86
 Visibility, 75, 76
 Volcanic dust, 6, 315
 V-shaped depressions, 183
- W
- Ward, R. deC., 297, 326, 374, 375
 Warm air masses, 238
 Warm fronts, 190, 235, 240
 Warning service of Weather Bureau, 355, 357
 Washington, D. C., 353, 355
 Water, heating of, 97
 Waterspouts, 225
 Water vapor, 5
 Waves:
 cold, 227

- Waves (Cont.):**
 electromagnetic, 86
 ether, 86
 Hertzian, 87
- Weather:**
 and boll weevil, 332
 and crops, 330
 and death rate, 322
 and grain rusts, 332
 and health, 321-325
 and oceans, 266-270
 and sun, 270-272
 control, 251
 correlations, 262-265
 cycles, 303-311
 defined, 12
 elements, 11
 forecasting, 233-254
 ideal, 324
 insurance, 252
 lore, 248
 maps, 176-182
 illustrated, 179-181, 245-247
 persistence of, 259-262
 proverbs, 250
 spells, 259
 types, 260
 variability of, 255-259
Weather and Crop Bulletin, 359
 Weather Bureau, 352-368
 Psychrometric Tables, 53
 publications, 364, 375
 Weather, elements of, 11-12
Weather Forecasting in the United States, 365
 Weather service, development of, 350-352
 Weekly weather outlook, 357
 Weightman, R. H., 365, 373, 374
 Westerlies, prevailing, 168
 Wet adiabatic rate, 104
 Wet-bulb potential temperature, 243
 Whirled psychrometer, 49
 Whirlwinds, 226
 Wiederanders, O., 222, 223
 Willett, H. C., 237, 371, 374
 Williston, N. D., 24
- Wind:**
 and health, 322
 antitrades, 170
 Beaufort scale, 35, 36
 blizzard, 228
- Wind (Cont.):**
 bora, 154
 canyon, 154
 chinook, 226
 direction, 34
 January mean, 165
 July mean, 166
 effect of altitude, 39
 effect of earth's rotation, 147
 foehn, 226
 geostrophic, 150
 gradient, 147-150
 gravity, 154
 high, 36
 hot, 227
 katabatic, 154
 mistral, 154
 monsoon, 155, 171
 observations, 33-40
 polar easterlies, 169
 pressure, 34
 prevailing westerlies, 168
 rose, 40
 shift line, 191
 sirocco, 227
 squalls, 41, 212
 structure, 37
 surface, 147, 150
 trades, 167
 vane, 34, 39
 variations, 41
 velocity, 34
- Winds due to local temperature differences, 151-154**
- X
- Xenon, 5
- Y
- Young, F. D., 374
 Yukon Territory, Canada, 289
- Z
- Zero, absolute, 9
 Zigzag lightning, 218
- Zones:**
 audibility, 118
 climatic, 296-299

